

75TH
YEAR ANNIVERSARY EDITION

Victor W.
RODWELL

David A.
BENDER

Kathleen M.
BOTHAM

Peter J.
KENNELLY

P. Anthony
WEIL

30TH EDITION

HARPER'S
ILLUSTRATED
BIOCHEMISTRY

Mc
Graw
Hill
Education

LANGE[®]

Contents

Preface xi

SECTION



Structures & Functions of Proteins & Enzymes 1

- 1 Biochemistry & Medicine 1**
Victor W. Rodwell, PhD & Robert K. Murray, MD, PhD
- 2 Water & pH 6**
Peter J. Kennelly, PhD & Victor W. Rodwell, PhD
- 3 Amino Acids & Peptides 15**
Peter J. Kennelly, PhD & Victor W. Rodwell, PhD
- 4 Proteins: Determination of Primary Structure 25**
Peter J. Kennelly, PhD & Victor W. Rodwell, PhD
- 5 Proteins: Higher Orders of Structure 36**
Peter J. Kennelly, PhD & Victor W. Rodwell, PhD

SECTION



Enzymes: Kinetics, Mechanism, Regulation, & Bioinformatics 51

- 6 Proteins: Myoglobin & Hemoglobin 51**
Peter J. Kennelly, PhD & Victor W. Rodwell, PhD
- 7 Enzymes: Mechanism of Action 60**
Peter J. Kennelly, PhD & Victor W. Rodwell, PhD
- 8 Enzymes: Kinetics 73**
Peter J. Kennelly, PhD & Victor W. Rodwell, PhD
- 9 Enzymes: Regulation of Activities 87**
Peter J. Kennelly, PhD & Victor W. Rodwell, PhD

10 Bioinformatics & Computational Biology 97

Peter J. Kennelly, PhD & Victor W. Rodwell, PhD

SECTION



Bioenergetics 113

- 11 Bioenergetics: The Role of ATP 113**
Kathleen M. Botham, PhD, DSc & Peter A. Mayes, PhD, DSc
- 12 Biologic Oxidation 119**
Kathleen M. Botham, PhD, DSc & Peter A. Mayes, PhD, DSc
- 13 The Respiratory Chain & Oxidative Phosphorylation 126**
Kathleen M. Botham, PhD, DSc & Peter A. Mayes, PhD, DSc

SECTION



Metabolism of Carbohydrates 139

- 14 Overview of Metabolism & the Provision of Metabolic Fuels 139**
David A. Bender, PhD & Peter A. Mayes, PhD, DSc
- 15 Carbohydrates of Physiological Significance 152**
David A. Bender, PhD & Peter A. Mayes, PhD, DSc
- 16 The Citric Acid Cycle: The Central Pathway of Carbohydrate, Lipid & Amino Acid Metabolism 161**
David A. Bender, PhD & Peter A. Mayes, PhD, DSc

CONTENTS

17 Glycolysis & the Oxidation of Pyruvate 168

David A. Bender, PhD & Peter A. Mayes, PhD, DSc

18 Metabolism of Glycogen 176

David A. Bender, PhD & Peter A. Mayes, PhD, DSc

19 Gluconeogenesis & the Control of Blood Glucose 185

David A. Bender, PhD & Peter A. Mayes, PhD, DSc

20 The Pentose Phosphate Pathway & Other Pathways of Hexose Metabolism 196

David A. Bender, PhD & Peter A. Mayes, PhD, DSc

SECTION

V

Metabolism of Lipids 211

21 Lipids of Physiologic Significance 211

Kathleen M. Botham, PhD, DSc & Peter A. Mayes, PhD, DSc

22 Oxidation of Fatty Acids: Ketogenesis 223

Kathleen M. Botham, PhD, DSc & Peter A. Mayes, PhD, DSc

23 Biosynthesis of Fatty Acids & Eicosanoids 232

Kathleen M. Botham, PhD, DSc & Peter A. Mayes, PhD, DSc

24 Metabolism of Acylglycerols & Sphingolipids 245

Kathleen M. Botham, PhD, DSc & Peter A. Mayes, PhD, DSc

25 Lipid Transport & Storage 253

Kathleen M. Botham, PhD, DSc & Peter A. Mayes, PhD, DSc

26 Cholesterol Synthesis, Transport, & Excretion 266

Kathleen M. Botham, PhD, DSc & Peter A. Mayes, PhD, DSc

SECTION

VI

Metabolism of Proteins & Amino Acids 281

27 Biosynthesis of the Nutritionally Nonessential Amino Acids 281

Victor W. Rodwell, PhD

28 Catabolism of Proteins & of Amino Acid Nitrogen 287

Victor W. Rodwell, PhD

29 Catabolism of the Carbon Skeletons of Amino Acids 297

Victor W. Rodwell, PhD

30 Conversion of Amino Acids to Specialized Products 313

Victor W. Rodwell, PhD

31 Porphyrins & Bile Pigments 323

Victor W. Rodwell, PhD & Robert K. Murray, MD, PhD

SECTION

VII

Structure, Function, & Replication of Informational Macromolecules 339

32 Nucleotides 339

Victor W. Rodwell, PhD

33 Metabolism of Purine & Pyrimidine Nucleotides 347

Victor W. Rodwell, PhD

34 Nucleic Acid Structure & Function 359

P. Anthony Weil, PhD

35 DNA Organization, Replication, & Repair 370

P. Anthony Weil, PhD

36 RNA Synthesis, Processing, & Modification 394

P. Anthony Weil, PhD

37 Protein Synthesis & the Genetic Code 413

P. Anthony Weil, PhD

38 Regulation of Gene Expression 428

P. Anthony Weil, PhD

39 Molecular Genetics, Recombinant DNA, & Genomic Technology 451

P. Anthony Weil, PhD

SECTION
VIIIBiochemistry of
Extracellular & Intracellular
Communication 477

- 40** Membranes: Structure & Function 477
Robert K. Murray, MD, PhD & P. Anthony Weil, PhD
- 41** The Diversity of the Endocrine System 498
P. Anthony Weil, PhD
- 42** Hormone Action & Signal Transduction 518
P. Anthony Weil, PhD

SECTION
IX

Special Topics (A) 537

- 43** Nutrition, Digestion, & Absorption 537
David A. Bender, PhD & Peter A. Mayes, PhD, DSc
- 44** Micronutrients: Vitamins & Minerals 546
David A. Bender, PhD
- 45** Free Radicals & Antioxidant Nutrients 564
David A. Bender, PhD
- 46** Glycoproteins 569
David A. Bender, PhD & Robert K. Murray, MD, PhD
- 47** Metabolism of Xenobiotics 583
David A. Bender, PhD & Robert K. Murray, MD, PhD
- 48** Clinical Biochemistry 589
David A. Bender, PhD, Joe Varghese, MBBS, MD, Molly Jacob, MBBS, MD, PhD, & Robert K. Murray, MD, PhD

SECTION
X

Special Topics (B) 607

- 49** Intracellular Traffic & Sorting of Proteins 607
Kathleen M. Botham, PhD, DSc & Robert K. Murray, MD, PhD
- 50** The Extracellular Matrix 627
Kathleen M. Botham, PhD, DSc & Robert K. Murray, MD, PhD
- 51** Muscle & the Cytoskeleton 647
Peter J. Kennelly, PhD & Robert K. Murray, MD, PhD
- 52** Plasma Proteins & Immunoglobulins 668
Peter J. Kennelly, PhD, Robert K. Murray, MD, PhD, Molly Jacob, MBBS, MD, PhD & Joe Varghese, MBBS, MD
- 53** Red Blood Cells 689
Peter J. Kennelly, PhD & Robert K. Murray, MD, PhD
- 54** White Blood Cells 700
Peter J. Kennelly, PhD & Robert K. Murray, MD, PhD

SECTION
XI

Special Topics (C) 711

- 55** Hemostasis & Thrombosis 711
Peter L. Gross, MD, MSc, FRCP(C), Robert K. Murray, MD, PhD, P. Anthony Weil, PhD, & Margaret L. Rand, PhD
- 56** Cancer: An Overview 722
Molly Jacob, MBBS, MD, PhD, Joe Varghese, MBBS, MD, Robert K. Murray, MD, PhD & P. Anthony Weil, PhD
- 57** Biochemical Case Histories 746
David A. Bender, PhD
- 58** The Biochemistry of Aging 755
Peter J. Kennelly, PhD

The Answer Bank 771
Index 777

Structures & Functions of Proteins & Enzymes

1

Biochemistry & Medicine

Victor W. Rodwell, PhD & Robert K. Murray, MD, PhD

OBJECTIVES

*After studying this chapter,
you should be able to:*

- Understand the importance of the ability of cell-free extracts of yeast to ferment sugars, an observation that enabled discovery of the intermediates of fermentation, glycolysis, and other metabolic pathways.
- Appreciate the scope of biochemistry and its central role in the life sciences, and that biochemistry and medicine are intimately related disciplines.
- Appreciate that biochemistry integrates knowledge of the chemical processes in living cells with strategies to maintain health, understand disease, identify potential therapies, and enhance our understanding of the origins of life on earth.
- Describe how genetic approaches have been critical for elucidating many areas of biochemistry, and how the Human Genome Project has furthered advances in numerous aspects of biology and medicine.

BIOMEDICAL IMPORTANCE

Biochemistry and medicine enjoy a mutually cooperative relationship. Biochemical studies have illuminated many aspects of health and disease, and the study of various aspects of health and disease has opened up new areas of biochemistry. The medical relevance of biochemistry both in normal and abnormal situations is emphasized throughout this book. Biochemistry makes significant contributions to the fields of cell biology, physiology, immunology, microbiology, pharmacology, and toxicology, as well as the fields of inflammation, cell injury, and cancer. These close relationships emphasize that life, as we know it, depends on biochemical reactions and processes.

BIOCHEMISTRY BEGAN WITH THE DISCOVERY THAT A CELL-FREE EXTRACT OF YEAST CAN FERMENT SUGAR

The knowledge that yeast can convert the sugars to ethyl alcohol predates recorded history. It was not, however, until the earliest years of the 20th century that this process led directly to the science of biochemistry. Despite his insightful investigations of brewing and wine making, the great French microbiologist Louis Pasteur maintained that the process of fermentation could only occur in intact cells. His error was shown in 1899 by the brothers Büchner, who discovered that

fermentation can indeed occur in cell-free extracts. This revelation resulted from storage of a yeast extract in a crock of concentrated sugar solution added as a preservative. Overnight, the contents of the crock fermented, spilled over the laboratory bench and floor, and dramatically demonstrated that fermentation can proceed in the absence of an intact cell. This discovery made possible a rapid and highly productive series of investigations in the early years of the 20th century that initiated the science of biochemistry. These investigations revealed the vital role of inorganic phosphate, ADP, ATP, and NAD(H), and ultimately identified the phosphorylated sugars and the chemical reactions and enzymes (Gk “in yeast”) that convert glucose to pyruvate (glycolysis) or to ethanol and CO₂ (fermentation). Subsequent research in the 1930s and 1940s identified the intermediates of the citric acid cycle and of urea biosynthesis, and provided insight into the essential roles of certain vitamin-derived cofactors or “coenzymes” such as thiamin pyrophosphate, riboflavin, and ultimately coenzyme A, coenzyme Q, and cobamide coenzymes. The 1950s revealed how complex carbohydrates are synthesized from, and broken down to simple sugars, and delineated the pathways for biosynthesis of pentoses and the breakdown of amino acids and lipids.

Animal models, perfused intact organs, tissue slices, cell homogenates and their subfractions, and purified enzymes all were used to isolate and identify metabolites and enzymes. These advances were made possible by the development in the late 1930s and early 1940s of techniques such as analytical ultracentrifugation, paper and other forms of chromatography, and the post-World War II availability of radioisotopes, principally ¹⁴C, ³H and ³²P, as “tracers” to identify the intermediates in complex pathways such as that leading to the biosynthesis of cholesterol and other isoprenoids and the pathways of amino acid biosynthesis and catabolism. X-ray crystallography was then used to solve the three-dimensional structure, first of myoglobin, and subsequently of numerous proteins, polynucleotides, enzymes, and viruses including that of the common cold. Genetic advances that followed the realization that DNA was a double helix include the polymerase chain reaction, and transgenic animals or those with gene knockouts. The methods

used to prepare, analyze, purify, and identify metabolites and the activities of natural and recombinant enzymes and their three-dimensional structures are discussed in the following chapters.

BIOCHEMISTRY & MEDICINE HAVE STIMULATED MUTUAL ADVANCES

The two major concerns for workers in the health sciences—and particularly physicians—are the understanding and maintenance of health and the understanding and effective treatment of disease. Biochemistry impacts both of these fundamental concerns, and the interrelationship of biochemistry and medicine is a wide, two-way street. Biochemical studies have illuminated many aspects of health and disease, and conversely, the study of various aspects of health and disease has opened up new areas of biochemistry (**Figure 1–1**). Knowledge of protein structure and function was necessary to identify and understand the single difference in amino acid sequence between normal hemoglobin and sickle cell hemoglobin, and analysis of numerous variant sickle cell and other hemoglobins has contributed significantly to our understanding of the structure and function both of normal hemoglobin and of other proteins. During the early 1900s the English physician Archibald Garrod studied patients with the relatively rare disorders of alkaptonuria, albinism, cystinuria, and pentosuria and established that these conditions were genetically determined. Garrod designated these conditions as **inborn errors of metabolism**. His insights provided a foundation for the development of the field of human biochemical genetics. A more recent example was investigation of the genetic and molecular basis of familial hypercholesterolemia, a disease that results in early onset atherosclerosis. In addition to clarifying different genetic mutations responsible for this disease, this provided a deeper understanding of cell receptors and mechanisms of uptake, not only of cholesterol, but of how other molecules’ cross cell membranes. Studies of **oncogenes** and **tumor suppressor genes** in cancer cells have directed

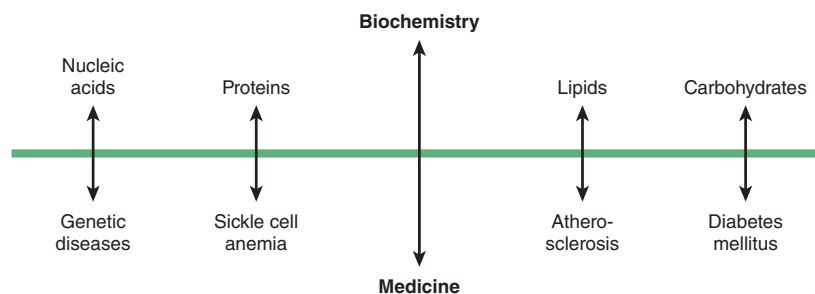

FIGURE 1–1 A two-way street connects biochemistry and medicine.

Knowledge of the biochemical topics listed above the green line of the diagram has clarified our understanding of the diseases shown below the green line. Conversely, analyses of the diseases have casted light on many areas of biochemistry. Note that sickle cell anemia is a genetic disease, and that both atherosclerosis and diabetes mellitus have genetic components.

attention to the molecular mechanisms involved in the control of normal cell growth. These examples illustrate how the study of disease can open up areas of basic biochemical research. Science provides physicians and other workers in health care and biology with a foundation that impacts practice, stimulates curiosity, and promotes the adoption of scientific approaches for continued learning. So long as medical treatment is firmly grounded in the knowledge of biochemistry and other basic sciences, the practice of medicine will have a rational basis capable of accommodating and adapting to new knowledge.

NORMAL BIOCHEMICAL PROCESSES ARE THE BASIS OF HEALTH

Biochemical Research Impacts Nutrition & Preventive Medicine

The World Health Organization (WHO) defines health as a state of “complete physical, mental, and social well-being and not merely the absence of disease and infirmity.” From a biochemical viewpoint, health may be considered that situation in which all of the many thousands of intra- and extracellular reactions that occur in the body are proceeding at rates commensurate with the organism’s survival under pressure from both internal and external challenges. The maintenance of health requires optimal dietary intake of a number of chemicals, chief among which are **vitamins**, certain **amino acids** and **fatty acids**, various **minerals**, and **water**. Understanding nutrition depends to a great extent on knowledge of biochemistry, and the sciences of biochemistry and nutrition share a focus on these chemicals. Recent increasing emphasis on systematic attempts to maintain health and forestall disease, or **preventive medicine**, includes nutritional approaches to the prevention of diseases such as atherosclerosis and cancer.

Most Diseases Have a Biochemical Basis

Apart from infectious organisms and environmental pollutants, many diseases are manifestations of abnormalities in genes, proteins, chemical reactions, or biochemical processes, each of which can adversely affect one or more critical biochemical functions. Examples of disturbances in human biochemistry responsible for diseases or other debilitating conditions include electrolyte imbalance, defective nutrient ingestion or absorption, hormonal imbalances, toxic chemicals or biologic agents, and DNA-based genetic disorders. To address these challenges, biochemical research continues to be interwoven with studies in disciplines such as genetics, cell biology, immunology, nutrition, pathology, and pharmacology. In addition, many biochemists are vitally interested in contributing to solutions to key issues such as the ultimate survival of mankind, and educating the public to support use of the scientific method in solving environmental and other major problems that confront us.

Impact of the Human Genome Project on Biochemistry, Biology, & Medicine

Initially unanticipated rapid progress in the late 1990s in sequencing the human genome led in mid-2000 to the announcement that over 90% of the genome had been sequenced. This effort was headed by the International Human Genome Sequencing Consortium and by Celera Genomics, a private company. Except for a few gaps, the sequence of the entire human genome was completed in 2003, just 50 years after the description of the double-helical nature of DNA by Watson and Crick. The implications for biochemistry, medicine, and indeed for all of biology, are virtually unlimited. For example, the ability to isolate and sequence a gene and to investigate its structure and function by sequencing and “gene knockout” experiments have revealed previously unknown genes and their products, and new insights have been gained concerning human evolution and procedures for identifying disease-related genes.

Major advances in biochemistry and understanding human health and disease continue to be made by mutation of the genomes of model organisms such as yeast and of eukaryotes such as the fruit fly *Drosophila melanogaster* and the round worm *Caenorhabditis elegans*. Each organism has a short generation time and can be genetically manipulated to provide insight into the functions of individual genes. These advances can potentially be translated into approaches that help humans by providing clues to curing human diseases such as cancer and Alzheimer disease. **Figure 1–2** highlights areas that have developed or accelerated as a direct result of progress made in the Human Genome Project (HGP). New “-omics” fields have blossomed, each of which focuses on comprehensive study of the structures and functions of the molecules with which each is concerned. Definitions of these -omics fields mentioned below appear in the Glossary of this chapter. The products of genes (RNA molecules and proteins) are being studied using the techniques of **transcriptomics** and **proteomics**. A spectacular example of the speed of progress in transcriptomics is the explosion of knowledge about small RNA molecules as regulators of gene activity. Other -omics fields include **glycomics**, **lipidomics**, **metabolomics**, **nutrigenomics**, and **pharmacogenomics**. To keep pace with the information generated, **bioinformatics** has received much attention. Other related fields to which the impetus from the HGP has carried over are **biotechnology**, **bioengineering**, **biophysics**, and **bioethics**. **Nanotechnology** is an active area, which, for example, may provide novel methods of diagnosis and treatment for cancer and other disorders. **Stem cell biology** is at the center of much current research. **Gene therapy** has yet to deliver the promise that it appears to offer, but it seems probable that ultimately will occur. Many new **molecular diagnostic tests** have developed in areas such as genetic, microbiologic, and immunologic testing and diagnosis. **Systems biology** is also burgeoning. The outcomes of research in the various areas mentioned above will impact tremendously the future of biology, medicine, and the health sciences. **Synthetic biology** offers the potential for

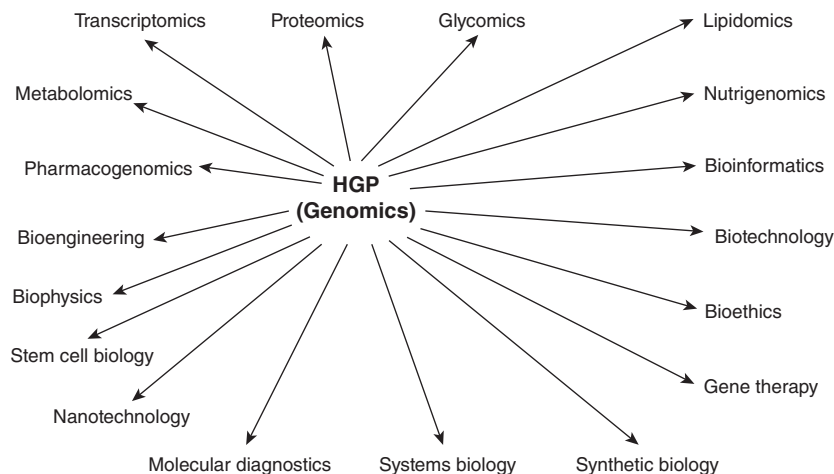

FIGURE 1–2 The Human Genome Project (HGP) has influenced many disciplines and areas of research. Biochemistry is not listed since it predates commencement of the HGP, but disciplines such as bioinformatics, genomics, glycomics, lipidomics, metabolomics, molecular diagnostics, proteomics, and transcriptomics are nevertheless active areas of biochemical research.

creating living organisms, initially small bacteria, from genetic material *in vitro* that might carry out specific tasks such as cleansing petroleum spills. All of the above make the 21st century an exhilarating time to be directly involved in biology and medicine.

SUMMARY

- Biochemistry is the science concerned with studying the various molecules that occur in living cells and organisms, the individual chemical reactions and their enzyme catalysts, and the expression and regulation of each metabolic process. Because life depends on biochemical reactions, biochemistry has become the basic language of all biologic sciences.
- Despite the focus on human biochemistry in this text, biochemistry concerns the entire spectrum of life forms, from relatively simple viruses and bacteria and plants to complex eukaryotes such as human beings.
- Biochemistry, medicine and other health care disciplines are intimately related. Health in all species depends on a harmonious balance of the biochemical reactions occurring in the body, while disease reflects abnormalities in biomolecules, biochemical reactions, or biochemical processes.
- Advances in biochemical knowledge have illuminated many areas of medicine, and the study of diseases has often revealed previously unsuspected aspects of biochemistry.
- Biochemical approaches are often fundamental in illuminating the causes of diseases and in designing appropriate therapies, and various biochemical laboratory tests represent an integral component of diagnosis and monitoring of treatment.
- A sound knowledge of biochemistry and of other related basic disciplines is essential for the rational practice of medicine and related health sciences.
- Results of the HGP and of research in related areas will have a profound influence on the future of biology, medicine, and other health sciences.

- Genomic research on model organisms such as yeast, the fruit fly *D. melanogaster*, and the round worm *C. elegans* provides insight into understanding human diseases

REFERENCES

- Alberts B: Model organisms and human health. *Science* 2010;330:1724.
- Alberts B: Lessons from genomics. *Science* 2011;331:511.
- Cammack R, Attwood T, Campbell P, et al (editors): *Oxford Dictionary of Biochemistry and Molecular Biology*. 2nd ed. Oxford University Press, 2006.
- Cooke M: Science for physicians. *Science* 2010;329:1573.
- Feero WG, Guttmacher AE, Collins FS: Genomic medicine—an updated primer. *N Engl J Med* 2010;362:2001.
- Gibson DG, Glass JI, Lartigue C, et al: Creation of a bacterial cell controlled by a chemically synthesized genome. *Science* 2010;329:52.
- Kornberg A: Centenary of the birth of modern biochemistry. *FASEB J* 1997;11:1209.
- Online Mendelian Inheritance in Man (OMIM): Center for Medical Genetics, Johns Hopkins University & National Center for Biotechnology Information, National Library of Medicine. <http://www.ncbi.nlm.nih.gov/omim/>.
- Scriver CR, Beaudet AL, Valle D, et al (editors): *The Metabolic and Molecular Bases of Inherited Disease*, 8th ed. McGraw-Hill, 2001. Available online and updated as *The Online Metabolic & Molecular Bases of Inherited Disease* at www.ommbid.com.
- Weatherall DJ: Systems biology and red cells. *N Engl J Med* 2011;364:376.

GLOSSARY

Bioengineering: The application of engineering to biology and medicine.

Bioethics: The area of ethics that is concerned with the application of moral and ethical principles to biology and medicine.

Bioinformatics: The discipline concerned with the collection, storage, and analysis of biologic data, mainly DNA and protein sequences (see Chapter 10).

Biophysics: The application of physics and its techniques to biology and medicine.

Biotechnology: The field in which biochemical, engineering, and other approaches are combined to develop biological products of use in medicine and industry.

Gene Therapy: Applies to the use of genetically engineered genes to treat various diseases.

Genomics: The genome is the complete set of genes of an organism, and genomics is the in-depth study of the structures and functions of genomes.

Glycomics: The glycome is the total complement of simple and complex carbohydrates in an organism. Glycomics is the systematic study of the structures and functions of glycomes such as the human glycome.

Lipidomics: The lipidome is the complete complement of lipids found in an organism. Lipidomics is the in-depth study of the structures and functions of all members of the lipidome and of their interactions, in both health and disease.

Metabolomics: The metabolome is the complete complement of metabolites (small molecules involved in metabolism) present in an organism. Metabolomics is the in-depth study of their structures, functions, and changes in various metabolic states.

Molecular Diagnostics: Refers to the use of molecular approaches such as DNA probes to assist in the diagnosis of various biochemical, genetic, immunologic, microbiologic, and other medical conditions.

Nanotechnology: The development and application to medicine and to other areas of devices such as nanoshells which are only a few nanometers in size (10^{-9} m = 1 nm).

Nutrigenomics: The systematic study of the effects of nutrients on genetic expression and of the effects of genetic variations on the metabolism of nutrients.

Pharmacogenomics: The use of genomic information and technologies to optimize the discovery and development of new drugs and drug targets.

Proteomics: The proteome is the complete complement of proteins of an organism. Proteomics is the systematic study of the structures and functions of proteomes and their variations in health and disease.

Stem Cell Biology: Stem cells are undifferentiated cells that have the potential to self-renew and to differentiate into any of the adult cells of an organism. Stem cell biology concerns the biology of stem cells and their potential for treating various diseases.

Synthetic Biology: The field that combines biomolecular techniques with engineering approaches to build new biological functions and systems.

Systems Biology: The field concerns complex biologic systems studied as integrated entities.

Transcriptomics: The comprehensive study of the transcriptome, the complete set of RNA transcripts produced by the genome during a fixed period of time.

Water & pH

Peter J. Kennelly, PhD & Victor W. Rodwell, PhD

OBJECTIVES

After studying this chapter, you should be able to:

- Describe the properties of water that account for its surface tension, viscosity, liquid state at ambient temperature, and solvent power.
- Use structural formulas to represent several organic compounds that can serve as hydrogen bond donors or acceptors.
- Explain the role played by entropy in the orientation, in an aqueous environment, of the polar and nonpolar regions of macromolecules.
- Indicate the quantitative contributions of salt bridges, hydrophobic interactions, and van der Waals forces to the stability of macromolecules.
- Explain the relationship of pH to acidity, alkalinity, and the quantitative determinants that characterize weak and strong acids.
- Calculate the shift in pH that accompanies the addition of a given quantity of acid or base to the pH of a buffered solution.
- Describe what buffers do, how they do it, and the conditions under which a buffer is most effective under physiologic or other conditions.
- Illustrate how the Henderson-Hasselbalch equation can be used to calculate the net charge on a polyelectrolyte at a given pH.

BIOMEDICAL IMPORTANCE

Water is the predominant chemical component of living organisms. Its unique physical properties, which include the ability to solvate a wide range of organic and inorganic molecules, derive from water's dipolar structure and exceptional capacity for forming hydrogen bonds. The manner in which water interacts with a solvated biomolecule influences the structure both of the biomolecule and of water itself. An excellent nucleophile, water is a reactant or product in many metabolic reactions. Regulation of water balance depends upon hypothalamic mechanisms that control thirst, on antidiuretic hormone (ADH), on retention or excretion of water by the kidneys, and on evaporative loss. Nephrogenic diabetes insipidus, which involves the inability to concentrate urine or adjust to subtle changes in extracellular fluid osmolarity, results from the unresponsiveness of renal tubular osmoreceptors to ADH.

Water has a slight propensity to dissociate into hydroxide ions and protons. The concentration of protons, or **acidity**, of aqueous solutions is generally reported using the logarithmic pH scale. Bicarbonate and other buffers normally maintain

the pH of extracellular fluid between 7.35 and 7.45. Suspected disturbances of acid-base balance are verified by measuring the pH of arterial blood and the CO₂ content of venous blood. Causes of acidosis (blood pH <7.35) include diabetic ketosis and lactic acidosis. Alkalosis (pH >7.45) may follow vomiting of acidic gastric contents.

WATER IS AN IDEAL BIOLOGIC SOLVENT

Water Molecules Form Dipoles

A water molecule is an irregular, slightly skewed tetrahedron with oxygen at its center (**Figure 2–1**). The two hydrogens and the unshared electrons of the remaining two *sp*³-hybridized orbitals occupy the corners of the tetrahedron. The 105° angle between the two hydrogen atoms differs slightly from the ideal tetrahedral angle, 109.5°. Ammonia is also tetrahedral, with a 107° angle between its three hydrogens. The strongly electro-negative oxygen atom in a water molecule attracts electrons

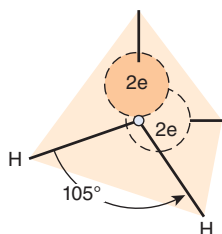

FIGURE 2-1 The water molecule has tetrahedral geometry.

away from the hydrogen nuclei, leaving them with a partial positive charge, while its two unshared electron pairs constitute a region of local negative charge.

A molecule with electrical charge distributed asymmetrically about its structure is referred to as a **dipole**. Water's strong dipole is responsible for its high **dielectric constant**. As described quantitatively by Coulomb's law, the strength of interaction F between oppositely charged particles is inversely proportionate to the dielectric constant ϵ of the surrounding medium. The dielectric constant for a vacuum is essentially unity; for hexane it is 1.9; for ethanol, 24.3; and for water at 25°C, 78.5. Water therefore greatly decreases the force of attraction between charged and polar species relative to water-free environments with lower dielectric constants. Its strong dipole and high dielectric constant enable water to dissolve large quantities of charged compounds such as salts.

Water Molecules Form Hydrogen Bonds

A partially unshielded hydrogen nucleus covalently bound to an electron-withdrawing oxygen or nitrogen atom can interact with an unshared electron pair on another oxygen or nitrogen atom to form a **hydrogen bond**. Since water molecules contain both of these features, hydrogen bonding favors the self-association of water molecules into ordered arrays (**Figure 2-2**). Hydrogen bonding profoundly influences the physical properties of water and accounts for its relatively high viscosity, surface tension, and boiling point. On average, each molecule in liquid water associates through hydrogen bonds with 3.5 others. These bonds are both relatively weak and transient, with a half-life of a few picoseconds. Rupture of a hydrogen bond in liquid water requires only about 4.5 kcal/mol, less than 5% of the energy required to rupture a covalent O—H bond.

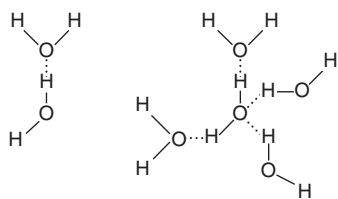

FIGURE 2-2 Water molecules self-associate via hydrogen bonds. Shown are the association of two water molecules (**left**) and a hydrogen-bonded cluster of four water molecules (**right**). Notice that water can serve simultaneously both as a hydrogen donor and as a hydrogen acceptor.

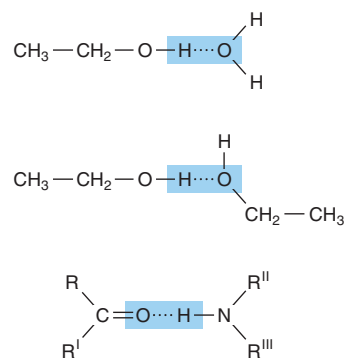

FIGURE 2-3 Additional polar groups participate in hydrogen bonding. Shown are hydrogen bonds formed between alcohol and water, between two molecules of ethanol, and between the peptide carbonyl oxygen and the peptide nitrogen hydrogen of an adjacent amino acid.

Hydrogen bonding enables water to dissolve many organic biomolecules that contain functional groups which can participate in hydrogen bonding. The oxygen atoms of aldehydes, ketones, and amides, for example, provide lone pairs of electrons that can serve as hydrogen acceptors. Alcohols, carboxylic acids, and amines can serve both as hydrogen acceptors and as donors of unshielded hydrogen atoms for formation of hydrogen bonds (**Figure 2-3**).

INTERACTION WITH WATER INFLUENCES THE STRUCTURE OF BIOMOLECULES

Covalent and Noncovalent Bonds Stabilize Biologic Molecules

The covalent bond is the strongest force that holds molecules together (**Table 2-1**). Noncovalent forces, while of lesser magnitude, make significant contributions to the structure, stability, and functional competence of macromolecules in living

TABLE 2-1 Bond Energies for Atoms of Biologic Significance

Bond Type	Energy (kcal/mol)	Bond Type	Energy (kcal/mol)
O—O	34	O=O	96
S—S	51	C—H	99
C—N	70	C=S	108
S—H	81	O—H	110
C—C	82	C=C	147
C—O	84	C=N	147
N—H	94	C=O	164

cells. These forces, which can be either attractive or repulsive, involve interactions both within the biomolecule and between it and the water that forms the principal component of the surrounding environment.

Biomolecules Fold to Position Polar & Charged Groups on Their Surfaces

Most biomolecules are **amphipathic**; that is, they possess regions rich in charged or polar functional groups as well as regions with hydrophobic character. Proteins tend to fold with the R-groups of amino acids with hydrophobic side chains in the interior. Amino acids with charged or polar amino acid side chains (eg, arginine, glutamate, serine, see Table 3–1) generally are present on the surface in contact with water. A similar pattern prevails in a phospholipid bilayer where the charged “head groups” of phosphatidylserine or phosphatidylethanolamine contact water while their hydrophobic fatty acyl side chains cluster together, excluding water (see Figure 40–5). This pattern maximizes the opportunities for the formation of energetically favorable charge-dipole, dipole-dipole, and hydrogen bonding interactions between polar groups on the biomolecule and water. It also minimizes energetically unfavorable contacts between water and hydrophobic groups.

Hydrophobic Interactions

Hydrophobic interaction refers to the tendency of nonpolar compounds to self-associate in an aqueous environment. This self-association is driven neither by mutual attraction nor by what are sometimes incorrectly referred to as “hydrophobic bonds.” Self-association minimizes the disruption of energetically favorable interactions between the surrounding water molecules.

While the hydrogens of nonpolar groups such as the methylene groups of hydrocarbons do not form hydrogen bonds, they do affect the structure of the water that surrounds them. Water molecules adjacent to a hydrophobic group are restricted in the number of orientations (degrees of freedom) that permit them to participate in the maximum number of energetically favorable hydrogen bonds. Maximal formation of multiple hydrogen bonds, which maximizes enthalpy, can be maintained only by increasing the order of the adjacent water molecules, with an accompanying decrease in entropy.

It follows from the second law of thermodynamics that the optimal free energy of a hydrocarbon-water mixture is a function of both maximal enthalpy (from hydrogen bonding) and highest entropy (maximum degrees of freedom). Thus, nonpolar molecules tend to form droplets that minimize exposed surface area and reduce the number of water molecules whose motional freedom becomes restricted. Similarly, in the aqueous environment of the living cell the hydrophobic portions of biopolymers tend to be buried inside the structure of the molecule, or within a lipid bilayer, minimizing contact with water.

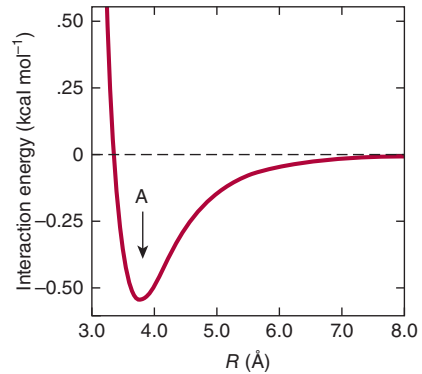

FIGURE 2–4 The strength of van der Waals interactions varies with the distance, R , between interacting species. The force of interaction between interacting species increases with decreasing distance between them until they are separated by the van der Waals contact distance (see arrow marked A). Repulsion due to interaction between the electron clouds of each atom or molecule then supervenes. While individual van der Waals interactions are extremely weak, their cumulative effect is nevertheless substantial for macromolecules such as DNA and proteins which have many atoms in close contact.

Electrostatic Interactions

Interactions between charged groups help shape biomolecular structure. Electrostatic interactions between oppositely charged groups within or between biomolecules are termed **salt bridges**. Salt bridges are comparable in strength to hydrogen bonds but act over larger distances. They therefore often facilitate the binding of charged molecules and ions to proteins and nucleic acids.

van der Waals Forces

van der Waals forces arise from attractions between transient dipoles generated by the rapid movement of electrons of all neutral atoms. Significantly weaker than hydrogen bonds but potentially extremely numerous, van der Waals forces decrease as the sixth power of the distance separating atoms (**Figure 2–4**). Thus, they act over very short distances, typically 2 to 4 Å.

Multiple Forces Stabilize Biomolecules

The DNA double helix illustrates the contribution of multiple forces to the structure of biomolecules. While each individual DNA strand is held together by covalent bonds, the two strands of the helix are held together exclusively by noncovalent interactions such as hydrogen bonds between nucleotide bases (Watson-Crick base pairing) and van der Waals interactions between the stacked purine and pyrimidine bases. The double helix presents the charged phosphate groups and polar hydroxyl groups from the ribose sugars of the DNA backbone to water while burying the relatively hydrophobic nucleotide bases inside. The extended backbone maximizes the distance between negatively charged phosphates, minimizing unfavorable electrostatic interactions (see Figure 34–2).

WATER IS AN EXCELLENT NUCLEOPHILE

Metabolic reactions often involve the attack by lone pairs of electrons residing on electron-rich molecules termed **nucleophiles** upon electron-poor atoms called **electrophiles**. Nucleophiles and electrophiles do not necessarily possess a formal negative or positive charge. Water, whose two lone pairs of sp^3 electrons bear a partial negative charge (see Figure 2–1), is an excellent nucleophile. Other nucleophiles of biologic importance include the oxygen atoms of phosphates, alcohols, and carboxylic acids; the sulfur of thiols; and the nitrogen atom of amines and of the imidazole ring of histidine. Common electrophiles include the carbonyl carbons in amides, esters, aldehydes, and ketones and the phosphorus atoms of phosphoesters.

Nucleophilic attack by water typically results in the cleavage of the amide, glycoside, or ester bonds that hold biopolymers together. This process is termed **hydrolysis**. Conversely, when monomer units are joined together to form biopolymers, such as proteins or glycogen, water is a product, for example, during the formation of a peptide bond between two amino acids.

While hydrolysis is a thermodynamically favored reaction, the amide and phosphoester bonds of polypeptides and oligonucleotides are stable in the aqueous environment of the cell. This seemingly paradoxical behavior reflects the fact that the thermodynamics that govern the equilibrium point of a reaction do not determine the *rate* at which it will proceed toward its equilibrium point. In the cell, protein catalysts called **enzymes** accelerate the rate of hydrolytic reactions when needed. **Proteases** catalyze the hydrolysis of proteins into their component amino acids, while **nucleases** catalyze the hydrolysis of the phosphoester bonds in DNA and RNA. Careful control of the activities of these enzymes is required to ensure that they act only at appropriate times.

Many Metabolic Reactions Involve Group Transfer

Many of the enzymic reactions responsible for synthesis and breakdown of biomolecules involve the transfer of a chemical group G from a donor D to an acceptor A to form an acceptor group complex, A—G:

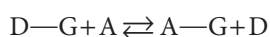

The hydrolysis and phosphorolysis of glycogen, for example, involve the transfer of glucosyl groups to water or to orthophosphate. The equilibrium constant for the hydrolysis of covalent bonds strongly favors the formation of split products. Conversely, many group transfer reactions responsible for the biosynthesis of macromolecules involve the thermodynamically unfavored formation of covalent bonds. Enzyme catalysts play a critical role in surmounting these barriers by virtue of their capacity to directly link two normally separate reactions together. By linking an energetically unfavorable group transfer reaction with a thermodynamically favorable reaction, such as

the hydrolysis of ATP, a new coupled reaction can be generated whose net *overall* change in free energy favors biopolymer synthesis.

Given the nucleophilic character of water and its high concentration in cells, why are biopolymers such as proteins and DNA relatively stable? And how can synthesis of biopolymers occur in an aqueous environment that favors hydrolysis? Central to both questions are the properties of enzymes. In the absence of enzymic catalysis, even reactions that are highly favored thermodynamically do not necessarily take place rapidly. Precise and differential control of enzyme activity and the sequestration of enzymes in specific organelles determine the physiologic circumstances under which a given biopolymer will be synthesized or degraded. The ability of enzyme active sites to sequester substrates in an environment from which water can be excluded facilitates biopolymer synthesis.

Water Molecules Exhibit a Slight but Important Tendency to Dissociate

The ability of water to ionize, while slight, is of central importance for life. Since water can act both as an acid and as a base, its ionization may be represented as an intermolecular proton transfer that forms a hydronium ion (H_3O^+) and a hydroxide ion (OH^-):

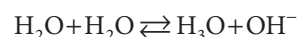

The transferred proton is actually associated with a cluster of water molecules. Protons exist in solution not only as H_3O^+ , but also as multimers such as $H_5O_2^+$ and $H_7O_3^+$. The proton is nevertheless routinely represented as H^+ , even though it is in fact highly hydrated.

Since hydronium and hydroxide ions continuously recombine to form water molecules, an *individual* hydrogen or oxygen cannot be stated to be present as an ion or as part of a water molecule. At one instant it is an ion; an instant later it is part of a water molecule. Individual ions or molecules are therefore not considered. We refer instead to the *probability* that at any instant in time a given hydrogen will be present as an ion or as part of a water molecule. Since 1 g of water contains 3.46×10^{22} molecules, the ionization of water can be described statistically. To state that the probability that a hydrogen exists as an ion is 0.01 means that at any given moment in time, a hydrogen atom has 1 chance in 100 of being an ion and 99 chances out of 100 of being part of a water molecule. The actual probability of a hydrogen atom in pure water existing as a hydrogen ion is approximately 1.8×10^{-9} . The probability of its being part of a water molecule thus is almost unity. Stated another way, for every hydrogen ion or hydroxide ion in pure water, there are 0.56 billion or 0.56×10^9 water molecules. Hydrogen ions and hydroxide ions nevertheless contribute significantly to the properties of water.

For dissociation of water,

$$K = \frac{[H^+][OH^-]}{[H_2O]}$$

where the brackets represent molar concentrations (strictly speaking, molar activities) and K is the **dissociation constant**. Since 1 mole (mol) of water weighs 18 g, 1 liter (L) (1000 g) of water contains $1000 \div 18 = 55.56$ mol. Pure water thus is 55.56 molar. Since the probability that a hydrogen in pure water will exist as a hydrogen ion is 1.8×10^{-9} , the molar concentration of H^+ ions (or of OH^- ions) in pure water is the product of the probability, 1.8×10^{-9} , times the molar concentration of water, 55.56 mol/L. The result is 1.0×10^{-7} mol/L.

We can now calculate the dissociation constant K for pure water:

$$K = \frac{[H^+][OH^-]}{[H_2O]} = \frac{[10^{-7}][10^{-7}]}{[55.56]} \\ = 0.018 \times 10^{-14} = 1.8 \times 10^{-16} \text{ mol/L}$$

The molar concentration of water, 55.56 mol/L, is too great to be significantly affected by dissociation. It is therefore considered to be essentially constant. This constant may therefore be incorporated into the dissociation constant K to provide a useful new constant K_w termed the **ion product** for water. The relationship between K_w and K is shown below:

$$K = \frac{[H^+][OH^-]}{[H_2O]} = 1.8 \times 10^{-16} \text{ mol/L} \\ K_w = (K)[H_2O] = [H^+][OH^-] \\ = (1.8 \times 10^{-16} \text{ mol/L})(55.56 \text{ mol/L}) \\ = 1.00 \times 10^{-14} (\text{mol/L})^2$$

Note that the dimensions of K are moles per liter and those of K_w are moles² per liter². As its name suggests, the ion product K_w is numerically equal to the product of the molar concentrations of H^+ and OH^- :

$$K_w = [H^+][OH^-]$$

At 25°C, $K_w = (10^{-7})^2$, or 10^{-14} (mol/L)². At temperatures below 25°C, K_w is somewhat less than 10^{-14} , and at temperatures above 25°C it is somewhat greater than 10^{-14} . Within the stated limitations of temperature, K_w equals 10^{-14} (mol/L)² for all aqueous solutions, even solutions of acids or bases. We use K_w to calculate the pH of acidic and basic solutions.

pH IS THE NEGATIVE LOG OF THE HYDROGEN ION CONCENTRATION

The term **pH** was introduced in 1909 by Sørensen, who defined it as the negative log of the hydrogen ion concentration:

$$\text{pH} = -\log[H^+]$$

This definition, while not rigorous, suffices for many biochemical purposes. To calculate the pH of a solution:

1. Calculate the hydrogen ion concentration $[H^+]$.

2. Calculate the base 10 logarithm of $[H^+]$.
3. pH is the negative of the value found in step 2.

For example, for pure water at 25°C,

$$\text{pH} = -\log[H^+] = -\log 10^{-7} = -(-7) = 7.0$$

This value is also known as the *power* (English), *puissant* (French), or *potenz* (German) of the exponent, hence the use of the term “p.”

Low pH values correspond to high concentrations of H^+ and high pH values correspond to low concentrations of H^+ .

Acids are **proton donors** and bases are **proton acceptors**. **Strong acids** (eg, HCl, H_2SO_4) completely dissociate into anions and protons even in strongly acidic solutions (low pH). **Weak acids** dissociate only partially in acidic solutions. Similarly, **strong bases** (eg, KOH, NaOH), but not **weak bases** like $Ca(OH)_2$, are completely dissociated even at high pH. Many biochemicals are weak acids. Exceptions include phosphorylated intermediates, whose phosphoryl group contains two dissociable protons, the first of which is strongly acidic.

The following examples illustrate how to calculate the pH of acidic and basic solutions.

Example 1: What is the pH of a solution whose hydrogen ion concentration is 3.2×10^{-4} mol/L?

$$\begin{aligned} \text{pH} &= -\log[H^+] \\ &= -\log(3.2 \times 10^{-4}) \\ &= -\log(3.2) - \log(10^{-4}) \\ &= -0.5 + 4.0 \\ &= 3.5 \end{aligned}$$

Example 2: What is the pH of a solution whose hydroxide ion concentration is 4.0×10^{-4} mol/L? We first define a quantity **pOH** that is equal to $-\log[OH^-]$ and that may be derived from the definition of K_w :

$$K_w = [H^+][OH^-] = 10^{-14}$$

Therefore,

$$\log[H^+] + \log[OH^-] = \log 10^{-14}$$

or

$$\text{pH} + \text{pOH} = 14$$

To solve the problem by this approach:

$$\begin{aligned} [OH^-] &= 4.0 \times 10^{-4} \\ \text{pOH} &= -\log[OH^-] \\ &= -\log(4.0 \times 10^{-4}) \\ &= -\log(4.0) - \log(10^{-4}) \\ &= -0.60 + 4.0 \\ &= 3.4 \end{aligned}$$

Now

$$\begin{aligned} \text{pH} &= 14 - \text{pOH} = 14 - 3.4 \\ &= 10.6 \end{aligned}$$

The examples above illustrate how the logarithmic pH scale facilitates recording and comparing hydrogen ion concentrations that differ by orders of magnitude from one another, 0.00032 M (pH 3.5) and 0.00000000025 M (pH 10.6).

Example 3: What are the pH values of (a) 2.0×10^{-2} mol/L KOH and of (b) 2.0×10^{-6} mol/L KOH? The OH^- arises from two sources, KOH and water. Since pH is determined by the total $[\text{H}^+]$ (and pOH by the total $[\text{OH}^-]$), both sources must be considered. In the first case (a), the contribution of water to the total $[\text{OH}^-]$ is negligible. The same cannot be said for the second case (b):

	Concentration (mol/L)	
	(a)	(b)
Molarity of KOH	2.0×10^{-2}	2.0×10^{-6}
$[\text{OH}^-]$ from KOH	2.0×10^{-2}	2.0×10^{-6}
$[\text{OH}^-]$ from water	1.0×10^{-7}	1.0×10^{-7}
Total $[\text{OH}^-]$	2.00001×10^{-2}	2.1×10^{-6}

Once a decision has been reached about the significance of the contribution by water, pH may be calculated as above.

The above examples assume that the strong base KOH is completely dissociated in solution and that the concentration of OH^- ions was thus equal to that due to the KOH plus that present initially in the water. This assumption is valid for dilute solutions of strong bases or acids, but not for weak bases or acids. Since weak electrolytes dissociate only slightly in solution, we must use the **dissociation constant** to calculate the concentration of $[\text{H}^+]$ (or $[\text{OH}^-]$) produced by a given molarity of a weak acid (or base) before calculating total $[\text{H}^+]$ (or total $[\text{OH}^-]$) and subsequently pH.

Functional Groups That Are Weak Acids Have Great Physiologic Significance

Many biochemicals possess functional groups that are weak acids or bases. Carboxyl groups, amino groups, and phosphate esters, whose second dissociation falls within the physiologic range, are present in proteins and nucleic acids, most coenzymes, and most intermediary metabolites. Knowledge of the dissociation of weak acids and bases thus is basic to understanding the influence of intracellular pH on structure and biologic activity. Charge-based separations such as electrophoresis and ion exchange chromatography are also best understood in terms of the dissociation behavior of functional groups.

We term the protonated species (HA or $\text{R}-\text{NH}_3^+$) the **acid** and the unprotonated species (A^- or $\text{R}-\text{NH}_2$) its **conjugate base**. Similarly, we may refer to a **base** (A^- or $\text{R}-\text{NH}_2$) and its **conjugate acid** (HA or $\text{R}-\text{NH}_3^+$).

We express the relative strengths of weak acids and bases in terms of their dissociation constants. Shown below are the expressions for the dissociation constant (K_a) for two representative weak acids, $\text{R}-\text{COOH}$ and $\text{R}-\text{NH}_3^+$.

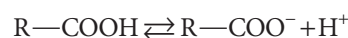

$$K_a = \frac{[\text{R}-\text{COO}^-][\text{H}^+]}{[\text{R}-\text{COOH}]}$$

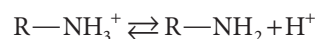

$$K_a = \frac{[\text{R}-\text{NH}_2][\text{H}^+]}{[\text{R}-\text{NH}_3^+]}$$

Since the numeric values of K_a for weak acids are negative exponential numbers, we express K_a as $\text{p}K_a$, where

$$\text{p}K_a = -\log K_a$$

Note that $\text{p}K_a$ is related to K_a as pH is to $[\text{H}^+]$. The stronger the acid, the lower is its $\text{p}K_a$ value.

Representative weak acids (left), their conjugate bases (center), and $\text{p}K_a$ values (right) include the following:

$\text{R}-\text{CH}_2-\text{COOH}$	$\text{R}-\text{CH}_2\text{COO}^-$	$\text{p}K_a = 4-5$
$\text{R}-\text{CH}_2-\text{NH}_3^+$	$\text{R}-\text{CH}_2-\text{NH}_2$	$\text{p}K_a = 9-10$
H_2CO_3	HCO_3^-	$\text{p}K_a = 6.4$
H_2PO_4^-	HPO_4^{2-}	$\text{p}K_a = 7.2$

$\text{p}K_a$ is used to express the relative strengths of both acids and bases. For any weak acid, its conjugate is a strong base. Similarly, the conjugate of a strong base is a weak acid. **The relative strengths of bases are expressed in terms of the $\text{p}K_a$ of their conjugate acids.** For polyprotic compounds containing more than one dissociable proton, a numerical subscript is assigned to each dissociation, numbered starting from unity in decreasing order of relative acidity. For a dissociation of the type

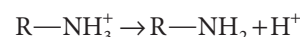

the $\text{p}K_a$ is the pH at which the concentration of the acid $\text{R}-\text{NH}_3^+$ equals that of the base $\text{R}-\text{NH}_2$.

From the above equations that relate K_a to $[\text{H}^+]$ and to the concentrations of undissociated acid and its conjugate base, when

$$[\text{R}-\text{COO}^-] = [\text{R}-\text{COOH}]$$

or when

$$[\text{R}-\text{NH}_2] = [\text{R}-\text{NH}_3^+]$$

then

$$K_a = [\text{H}^+]$$

Thus, when the associated (protonated) and dissociated (conjugate base) species are present at equal concentrations,

the prevailing hydrogen ion concentration $[H^+]$ is numerically equal to the dissociation constant, K_a . If the logarithms of both sides of the above equation are taken and both sides are multiplied by -1 , the expressions would be as follows:

$$K_a = [H^+]$$

$$-\log K_a = -\log [H^+]$$

Since $-\log K_a$ is defined as pK_a , and $-\log [H^+]$ defines pH, the equation may be rewritten as

$$pK_a = \text{pH}$$

that is, **the pK_a of an acid group is the pH at which the protonated and unprotonated species are present at equal concentrations.** The pK_a for an acid may be determined by adding 0.5 equivalent of alkali per equivalent of acid. The resulting pH will equal the pK_a of the acid.

The Henderson-Hasselbalch Equation Describes the Behavior of Weak Acids & Buffers

The Henderson-Hasselbalch equation is derived below.

A weak acid, HA, ionizes as follows:

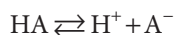

The equilibrium constant for this dissociation is

$$K_a = \frac{[H^+][A^-]}{[HA]}$$

Cross-multiplication gives

$$[H^+][A^-] = K_a[HA]$$

Divide both sides by $[A^-]$:

$$[H^+] = K_a \frac{[HA]}{[A^-]}$$

Take the log of both sides:

$$\log[H^+] = \log\left(K_a \frac{[HA]}{[A^-]}\right)$$

$$= \log K_a + \log \frac{[HA]}{[A^-]}$$

Multiply through by -1 :

$$-\log[H^+] = -\log K_a - \log \frac{[HA]}{[A^-]}$$

Substitute pH and pK_a for $-\log [H^+]$ and $-\log K_a$, respectively; then

$$\text{pH} = pK_a - \log \frac{[HA]}{[A^-]}$$

Inversion of the last term removes the minus sign and gives the **Henderson-Hasselbalch equation**

$$\text{pH} = pK_a + \log \frac{[A^-]}{[HA]}$$

The Henderson-Hasselbalch equation has great predictive value in protonic equilibria. For example,

1. When an acid is exactly half-neutralized, $[A^-] = [HA]$. Under these conditions,

$$\text{pH} = pK_a + \log \frac{[A^-]}{[HA]} = pK_a + \log \left(\frac{1}{1}\right) = pK_a + 0$$

Therefore, at half-neutralization, $\text{pH} = pK_a$.

2. When the ratio $[A^-]/[HA] = 100:1$,

$$\text{pH} = pK_a + \log \frac{[A^-]}{[HA]}$$

$$\text{pH} = pK_a + \log(100/1) = pK_a + 2$$

3. When the ratio $[A^-]/[HA] = 1:10$,

$$\text{pH} = pK_a + \log(1/10) = pK_a + (-1)$$

If the equation is evaluated at ratios of $[A^-]/[HA]$ ranging from 10^3 to 10^{-3} and the calculated pH values are plotted, the resulting graph describes the titration curve for a weak acid (**Figure 2-5**).

Solutions of Weak Acids & Their Salts Buffer Changes in pH

Solutions of weak acids or bases and their conjugates exhibit **buffering**, the ability to resist a change in pH following addition of strong acid or base. Many metabolic reactions are accompanied by the release or uptake of protons. Oxidative metabolism produces CO_2 , the anhydride of carbonic acid, which if not buffered would produce severe acidosis. Biologic maintenance of a constant pH involves buffering by phosphate, bicarbonate, and proteins, which accept or release protons to

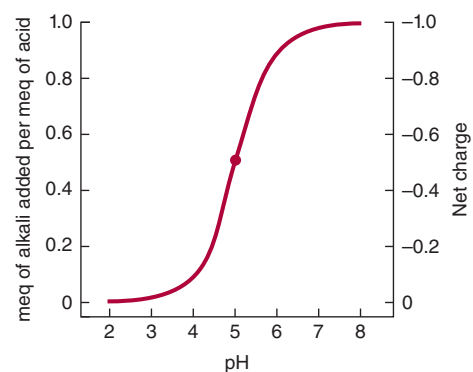

FIGURE 2-5 Titration curve for an acid of the type HA. The heavy dot in the center of the curve indicates the pK_a , 5.0.

resist a change in pH. For laboratory experiments using tissue extracts or enzymes, constant pH is maintained by the addition of buffers such as MES ([2-*N*-morpholino]-ethanesulfonic acid, pK_a 6.1), inorganic orthophosphate (pK_{a2} 7.2), HEPES (*N*-hydroxyethylpiperazine-*N'*-2-ethanesulfonic acid, pK_a 6.8), or Tris (tris[hydroxymethyl]aminomethane, pK_a 8.3). The value of pK_a relative to the desired pH is the major determinant of which buffer is selected.

Buffering can be observed by using a pH meter while titrating a weak acid or base (Figure 2–5). We can also calculate the pH shift that accompanies addition of acid or base to a buffered solution. In the example below, the buffered solution (a weak acid, $pK_a = 5.0$, and its conjugate base) is initially at one of four pH values. We will calculate the pH shift that results when 0.1 meq of KOH is added to 1 meq of each solution:

Initial pH	5.00	5.37	5.60	5.86
$[A^-]_{\text{initial}}$	0.50	0.70	0.80	0.88
$[HA]_{\text{initial}}$	0.50	0.30	0.20	0.12
$([A^-]/[HA])_{\text{initial}}$	1.00	2.33	4.00	7.33
Addition of 0.1 meq of KOH Produces				
$[A^-]_{\text{final}}$	0.60	0.80	0.90	0.98
$[HA]_{\text{final}}$	0.40	0.20	0.10	0.02
$([A^-]/[HA])_{\text{final}}$	1.50	4.00	9.00	49.0
$\log ([A^-]/[HA])_{\text{final}}$	0.18	0.60	0.95	1.69
Final pH	5.18	5.60	5.95	6.69
ΔpH	0.18	0.60	0.95	1.69

Notice that ΔpH , the change in pH per milliequivalent of OH^- added, depends on the initial pH. The solution resists changes in pH most effectively at pH values close to the pK_a . **A solution of a weak acid and its conjugate base buffers most effectively in the pH range $pK_a \pm 1.0$ pH unit.**

Figure 2–5 also illustrates how the net charge on one molecule of the acid varies with pH. A fractional charge of -0.5 does not mean that an individual molecule bears a fractional charge but that the *probability* is 0.5 that a given molecule has a unit negative charge at any given moment in time. Consideration of the net charge on macromolecules as a function of pH provides the basis for separatory techniques such as ion exchange chromatography and electrophoresis (see Chapter 4).

Acid Strength Depends on Molecular Structure

Many acids of biologic interest possess more than one dissociating group. The presence of local negative charge hinders proton release from nearby acidic groups, raising their pK_a . This is illustrated by the pK_a values of the three dissociating groups of phosphoric acid and citric acid (Table 2–2). The effect of adjacent charge decreases with distance. The second pK_a for

TABLE 2–2 Relative Strengths of Selected Acids of Biologic Significance

Monoprotic Acids		
Formic	pK	3.75
Lactic	pK	3.86
Acetic	pK	4.76
Ammonium ion	pK	9.25
Diprotic Acids		
Carbonic	pK_1	6.37
	pK_2	10.25
Succinic	pK_1	4.21
	pK_2	5.64
Glutaric	pK_1	4.34
	pK_2	5.41
Triprotic Acids		
Phosphoric	pK_1	2.15
	pK_2	6.82
	pK_3	12.38
Citric	pK_1	3.08
	pK_2	4.74
	pK_3	5.40

Note: Tabulated values are the pK_a values ($-\log$ of the dissociation constant) of selected monoprotic, diprotic, and triprotic acids.

succinic acid, which has two methylene groups between its carboxyl groups, is 5.6, whereas the second pK_a for glutaric acid, which has one additional methylene group, is 5.4.

pK_a Values Depend on the Properties of the Medium

The pK_a of a functional group is also profoundly influenced by the surrounding medium. The medium may either raise or lower the pK_a relative to its value in water, depending on whether the undissociated acid or its conjugate base is the charged species. The effect of dielectric constant on pK_a may be observed by adding ethanol to water. The pK_a of a carboxylic acid *increases*, whereas that of an amine *decreases* because ethanol decreases the ability of water to solvate a charged species. The pK_a values of dissociating groups in the interiors of proteins thus are profoundly affected by their local environment, including the presence or absence of water.

SUMMARY

- Water forms hydrogen-bonded clusters with itself and with other proton donors or acceptors. Hydrogen bonds account for the surface tension, viscosity, liquid state at room temperature, and solvent power of water.

- Compounds that contain O or N can serve as hydrogen bond donors and/or acceptors.
- Entropic forces dictate that macromolecules expose polar regions to an aqueous interface and bury nonpolar regions.
- Salt bridges, hydrophobic interactions, and van der Waals forces participate in maintaining molecular structure.
- pH is the negative log of $[H^+]$. A low pH characterizes an acidic solution, and a high pH denotes a basic solution.
- The strength of weak acids is expressed by pK_a , the negative log of the acid dissociation constant. Strong acids have low pK_a values and weak acids have high pK_a values.
- Buffers resist a change in pH when protons are produced or consumed. Maximum buffering capacity occurs ± 1 pH unit on either side of pK_a . Physiologic buffers include bicarbonate, orthophosphate, and proteins.

REFERENCES

- Reese KM: Whence came the symbol pH. *Chem & Eng News* 2004;82:64.
- Segel IM: *Biochemical Calculations*. Wiley, 1968.
- Skinner JL: Following the motions of water molecules in aqueous solutions. *Science* 2010;328:985.
- Stillinger FH: Water revisited. *Science* 1980;209:451.
- Suresh SJ, Naik VM: Hydrogen bond thermodynamic properties of water from dielectric constant data. *J Chem Phys* 2000;113:9727.
- Wiggins PM: Role of water in some biological processes. *Microbiol Rev* 1990;54:432.

Amino Acids & Peptides

Peter J. Kennelly, PhD & Victor W. Rodwell, PhD

OBJECTIVES

After studying this chapter, you should be able to:

- Diagram the structures and write the three- and one-letter designations for each of the amino acids present in proteins.
- Describe the contribution of each type of R group of the protein amino acids to their chemical properties.
- List additional key functions of amino acids and explain how certain amino acids in plant seeds can severely impact human health.
- Name the ionizable groups of the protein amino acids and list their approximate pK_a values as free amino acids in aqueous solution.
- Calculate the pH of an unbuffered aqueous solution of a polyfunctional amino acid and the change in pH that occurs following the addition of a given quantity of strong acid or alkali.
- Define pI and explain its relationship to the net charge on a polyfunctional electrolyte.
- Explain how pH, pK_a and pI can be used to predict the mobility of a polyelectrolyte, such as an amino acid, in a direct-current electrical field.
- Describe the directionality, nomenclature, and primary structure of peptides.
- Describe the conformational consequences of the partial double-bond character of the peptide bond and identify the bonds in the peptide backbone that are free to rotate.

BIOMEDICAL IMPORTANCE

In addition to providing the monomer units from which the long polypeptide chains of proteins are synthesized, the L- α -amino acids and their derivatives participate in cellular functions as diverse as nerve transmission and the biosynthesis of porphyrins, purines, pyrimidines, and urea. The neuroendocrine system employs short polymers of amino acids called *peptides* as hormones, hormone-releasing factors, neuro-modulators, and neurotransmitters. Humans and other higher animals cannot synthesize 10 of the L- α -amino acids present in proteins in amounts adequate to support infant growth or to maintain adult health. Consequently, the human diet must contain adequate quantities of these *nutritionally essential* amino acids. Each day the kidneys filter over 50 g of free amino acids from the arterial renal blood. However, only traces of free amino acids normally appear in the urine because amino acids

are almost totally reabsorbed in the proximal tubule, conserving them for protein synthesis and other vital functions. Not all amino acids are, however, beneficial. While their proteins contain only L- α -amino acids, some microorganisms secrete mixtures of D-amino acids. Many bacteria elaborate peptides that contain both D- and L- α -amino acids, several of which possess therapeutic value, including the antibiotics bacitracin and gramicidin A and the antitumor agent bleomycin. Certain other microbial peptides are toxic. The cyanobacterial peptides microcystin and nodularin are lethal in large doses, while small quantities promote the formation of hepatic tumors. The ingestion of certain amino acids present in the seeds of legumes of the genus *Lathyrus* results in lathyrism, a tragic irreversible disease in which individuals lose control of their limbs. Certain other plant seed amino acids have also been implicated in neurodegenerative disease in natives of Guam.

PROPERTIES OF AMINO ACIDS

The Genetic Code Specifies

20 L- α -Amino Acids

Although more than 300 amino acids occur in nature, proteins are synthesized almost exclusively from the set of 20 L- α -amino acids encoded by nucleotide triplets called **codons** (see Table 37-1). While the three-letter genetic code could potentially accommodate more than 20 amino acids, the genetic code is redundant since several amino acids are specified by multiple codons. Scientists frequently represent the sequences of peptides and proteins using one- and three-letter abbreviations for each amino acid (Table 3-1). These amino acids can be characterized as being either hydrophilic or hydrophobic (Table 3-2), properties that affect their location in a protein's mature folded conformation (see Chapter 5). Some proteins contain additional amino acids that arise by the **post-translational** modification of an amino acid already present in a peptide. Examples include the conversion of peptidyl proline and peptidyl lysine to 4-hydroxyproline and

5-hydroxylysine; the conversion of peptidyl glutamate to γ -carboxyglutamate; and the methylation, formylation, acetylation, prenylation, and phosphorylation of certain aminoacyl residues. These modifications significantly extend the biologic diversity of proteins by altering their solubility, stability, catalytic activity, and interaction with other proteins.

Selenocysteine, the 21st Protein L- α -Amino Acid

Selenocysteine (Figure 3-1) is an L- α -amino acid found in proteins from every domain of life. Humans contain approximately two dozen selenoproteins that include certain peroxidases and reductases, selenoprotein P, which circulates in the plasma, and the iodothyronine deiodinases responsible for converting the prohormone thyroxine (T4) to the thyroid hormone 3,3',5'-triiodothyronine (T3) (see Chapter 41). As its name implies, a selenium atom replaces the sulfur of its elemental analog, cysteine. Selenocysteine is not the product of a posttranslational modification, but is inserted directly into a growing polypeptide during translation. Selenocysteine thus

TABLE 3-1 L- α -Amino Acids Present in Proteins

Name	Symbol	Structural Formula	pK_1	pK_2	pK_3
With Aliphatic Side Chains			α -COOH	α -NH ₃ ⁺	R Group
Glycine	Gly [G]	$\begin{array}{c} \text{H}-\text{CH}-\text{COO}^- \\ \\ \text{NH}_3^+ \end{array}$	2.4	9.8	
Alanine	Ala [A]	$\begin{array}{c} \text{CH}_3-\text{CH}-\text{COO}^- \\ \\ \text{NH}_3^+ \end{array}$	2.4	9.9	
Valine	Val [V]	$\begin{array}{c} \text{H}_3\text{C} \\ \\ \text{CH}-\text{CH}-\text{COO}^- \\ \\ \text{H}_3\text{C} \\ \\ \text{NH}_3^+ \end{array}$	2.2	9.7	
Leucine	Leu [L]	$\begin{array}{c} \text{H}_3\text{C} \\ \\ \text{CH}-\text{CH}_2-\text{CH}-\text{COO}^- \\ \\ \text{H}_3\text{C} \\ \\ \text{NH}_3^+ \end{array}$	2.3	9.7	
Isoleucine	Ile [I]	$\begin{array}{c} \text{CH}_3 \\ \\ \text{CH}_2 \\ \\ \text{CH}-\text{CH}-\text{COO}^- \\ \\ \text{CH}_3 \\ \\ \text{NH}_3^+ \end{array}$	2.3	9.8	
With Side Chains Containing Hydroxylic (OH) Groups					
Serine	Ser [S]	$\begin{array}{c} \text{CH}_2-\text{CH}-\text{COO}^- \\ \\ \text{OH} \\ \\ \text{NH}_3^+ \end{array}$	2.2	9.2	about 13
Threonine	Thr [T]	$\begin{array}{c} \text{CH}_3-\text{CH}-\text{CH}-\text{COO}^- \\ \\ \text{OH} \\ \\ \text{NH}_3^+ \end{array}$	2.1	9.1	about 13
Tyrosine	Tyr [Y]	See below.			

(continued)

TABLE 3-1 L- α -Amino Acids Present in Proteins (continued)

Name	Symbol	Structural Formula	pK ₁	pK ₂	pK ₃
With Side Chains Containing Sulfur Atoms					
Cysteine	Cys [C]	$\begin{array}{c} \text{CH}_2 - \text{CH} - \text{COO}^- \\ \quad \\ \text{SH} \quad \text{NH}_3^+ \end{array}$	1.9	10.8	8.3
Methionine	Met [M]	$\begin{array}{c} \text{CH}_2 - \text{CH}_2 - \text{CH} - \text{COO}^- \\ \quad \\ \text{S} - \text{CH}_3 \quad \text{NH}_3^+ \end{array}$	2.1	9.3	
With Side Chains Containing Acidic Groups or Their Amides					
Aspartic acid	Asp [D]	$\begin{array}{c} -\text{OOC} - \text{CH}_2 - \text{CH} - \text{COO}^- \\ \\ \text{NH}_3^+ \end{array}$	2.1	9.9	3.9
Asparagine	Asn [N]	$\begin{array}{c} \text{H}_2\text{N} - \text{C} - \text{CH}_2 - \text{CH} - \text{COO}^- \\ \quad \\ \text{O} \quad \text{NH}_3^+ \end{array}$	2.1	8.8	
Glutamic acid	Glu [E]	$\begin{array}{c} -\text{OOC} - \text{CH}_2 - \text{CH}_2 - \text{CH} - \text{COO}^- \\ \\ \text{NH}_3^+ \end{array}$	2.1	9.5	4.1
Glutamine	Gln [Q]	$\begin{array}{c} \text{H}_2\text{N} - \text{C} - \text{CH}_2 - \text{CH}_2 - \text{CH} - \text{COO}^- \\ \quad \\ \text{O} \quad \text{NH}_3^+ \end{array}$	2.2	9.1	
With Side Chains Containing Basic Groups					
Arginine	Arg [R]	$\begin{array}{c} \text{H} - \text{N} - \text{CH}_2 - \text{CH}_2 - \text{CH}_2 - \text{CH} - \text{COO}^- \\ \quad \\ \text{C} = \text{NH}_2^+ \quad \text{NH}_3^+ \\ \\ \text{NH}_2 \end{array}$	1.8	9.0	12.5
Lysine	Lys [K]	$\begin{array}{c} \text{CH}_2 - \text{CH}_2 - \text{CH}_2 - \text{CH}_2 - \text{CH} - \text{COO}^- \\ \quad \\ \text{NH}_3^+ \quad \text{NH}_3^+ \end{array}$	2.2	9.2	10.8
Histidine	His [H]	$\begin{array}{c} \text{Imidazole ring} - \text{CH}_2 - \text{CH} - \text{COO}^- \\ \\ \text{NH}_3^+ \end{array}$	1.8	9.3	6.0
Containing Aromatic Rings					
Histidine	His [H]	See above.			
Phenylalanine	Phe [F]	$\begin{array}{c} \text{Phenyl ring} - \text{CH}_2 - \text{CH} - \text{COO}^- \\ \\ \text{NH}_3^+ \end{array}$	2.2	9.2	
Tyrosine	Tyr [Y]	$\begin{array}{c} \text{HO} - \text{Phenyl ring} - \text{CH}_2 - \text{CH} - \text{COO}^- \\ \\ \text{NH}_3^+ \end{array}$	2.2	9.1	10.1
Tryptophan	Trp [W]	$\begin{array}{c} \text{Indole ring} - \text{CH}_2 - \text{CH} - \text{COO}^- \\ \\ \text{NH}_3^+ \end{array}$	2.4	9.4	
Imino Acid					
Proline	Pro [P]	$\begin{array}{c} \text{Five-membered ring} \\ \\ \text{N}^+ - \text{H}_2 \\ \\ \text{COO}^- \end{array}$	2.0	10.6	

TABLE 3-2 Hydrophilic & Hydrophobic Amino Acids

Hydrophilic	Hydrophobic
Arginine	Alanine
Asparagine	Isoleucine
Aspartic acid	Leucine
Cysteine	Methionine
Glutamic acid	Phenylalanine
Glutamine	Proline
Glycine	Tryptophan
Histidine	Tyrosine
Lysine	Valine
Serine	
Threonine	

The distinction is based on the tendency to associate with, or to minimize contact with, an aqueous environment.

is commonly termed the “21st amino acid.” However, unlike the other 20 protein amino acids, incorporation of selenocysteine is specified by a large and complex genetic element for the unusual tRNA called tRNA^{Sec} which utilizes the UGA anticodon that normally signals STOP. However, the protein synthetic apparatus can identify a selenocysteine-specific UGA codon by the presence of an accompanying stem-loop structure, the selenocysteine insertion element, in the untranslated region of the mRNA (see Chapter 27).

Stereochemistry of the Protein Amino Acids

With the sole exception of glycine, the α -carbon of every amino acid is chiral. Although some protein amino acids are dextrorotatory and some levorotatory, all share the absolute configuration of L-glyceraldehyde and thus are defined as L- α -amino acids. Even though almost all protein amino acids are (R), the failure to use (R) or (S) to express *absolute* stereochemistry is no mere historical aberration. L-Cysteine is (S) since the atomic mass of the sulfur atom on C-3 exceeds that of the amino group on C2. More significantly, in mammals the biochemical reactions of L- α -amino acids, their precursors and their catabolites are catalyzed by enzymes that act exclusively on L-isomers, irrespective of their absolute configuration.

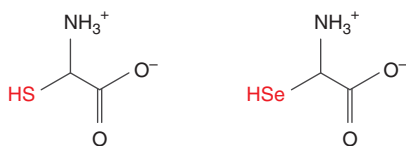

FIGURE 3-1 Cysteine (left) & selenocysteine (right). pK_3 for the selenyl proton of selenocysteine is 5.2. Since this is 3 pH units lower than that of cysteine, selenocysteine represents a better nucleophile at or below pH 7.4.

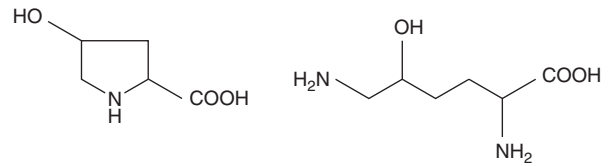

FIGURE 3-2 4-Hydroxyproline & 5-hydroxylysine.

Posttranslational Modifications Confer Additional Properties

While some prokaryotes incorporate pyrrolysine into proteins, and plants can incorporate azetidine-2-carboxylic acid, an analog of proline, a set of just 21 L- α -amino acids clearly suffices for the formation of most proteins. Posttranslational modifications can, however, generate novel R-groups that impart further properties. In collagen, for example, protein-bound proline and lysine residues are converted to 4-hydroxyproline and 5-hydroxylysine (**Figure 3-2**). The carboxylation of glutamyl residues of proteins of the coagulation cascade to γ -carboxyglutamyl residues (**Figure 3-3**) forms a chelating group for the calcium ion essential for blood coagulation. The amino acid side chains of histones are subject to numerous modifications, including acetylation and methylation of lysine and methylation and deamination of arginine (see Chapters 35 and 37). It also now is possible in the laboratory to genetically introduce many different unnatural amino acids into proteins, generating proteins via recombinant gene expression with new or enhanced properties and providing a new way to explore protein structure-function relationships.

Extraterrestrial Amino Acids Have Been Detected in Meteorites

In February 2013, the explosion of an approximately 20,000 metric ton meteor in the skies above Chelyabinsk, Western Siberia, dramatically demonstrated the potential destructive power of those extraterrestrial bodies. However, not all the effects of meteors are necessarily undesirable. Some meteorites, the remnants of asteroids that have reached earth, contain traces of several α -amino acids. These include the protein amino acids Ala, Asp, Glu, Gly, Ile, Leu, Phe, Ser, Thr, Tyr, and Val, as well as biologically important nonprotein α -amino acids such as N-methylglycine (sarcosine) and β -alanine.

Extraterrestrial amino acids were first reported in 1969 following analysis of the famous Murchison meteorite from southeastern Australia. The presence of amino acids in other meteorites, including some pristine examples from Antarctica,

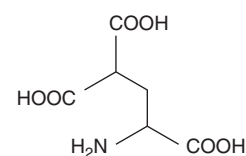

FIGURE 3-3 γ -Carboxyglutamic acid.

has now been amply confirmed. Unlike terrestrial amino acids, these meteorites contain racemic mixtures of D- and L-isomers of 3- to 5-carbon amino acids, as well as many additional amino acids that lack terrestrial counterparts of biotic origin. In addition, nucleobases, activated phosphates and molecules related to sugars have also been detected in meteorites. These findings offer potential insights into the prebiotic chemistry of Earth, and impact the search for extraterrestrial life. Some speculate that, by delivering extraterrestrially generated organic molecules to the early earth, meteorites may have contributed to the origin of life on our planet.

L- α -Amino Acids Serve Additional Metabolic Roles

L- α -Amino acids fulfill vital metabolic roles in addition to serving as the “building blocks” of proteins. As discussed in later chapters, thyroid hormones are formed from tyrosine; glutamate serves as a neurotransmitter as well as the precursor of γ -aminobutyric acid (GABA); ornithine and citrulline are intermediates in urea biosynthesis; and homocysteine, homoserine, and glutamate- γ -semialdehyde participate in the intermediary metabolism of the protein amino acids (Table 3–3). The protein amino acids phenylalanine and tyrosine serve as precursors of epinephrine, norepinephrine, and DOPA (dihydroxyphenylalanine).

TABLE 3–3 Examples of Nonprotein L- α -Amino Acids

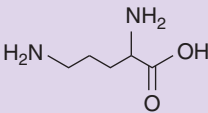
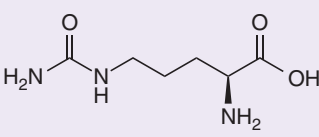
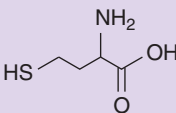
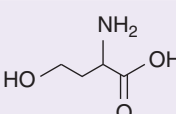
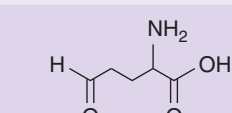
Amino Acid	Function
 <p>Ornithine</p>	Intermediate in urea synthesis (Figure 28-13).
 <p>Citrulline</p>	Intermediate in urea synthesis (Figure 28-13).
 <p>Homocysteine</p>	Intermediate in cysteine biosynthesis (Figure 27-9).
 <p>Homoserine</p>	Product of cysteine biosynthesis (Figure 27-9).
 <p>Glutamate-γ-semialdehyde</p>	Serine catabolite (Figure 29-3).

Certain Plant L- α -Amino Acids Can Adversely Impact Human Health

The consumption of certain nonprotein amino acids present in plants can adversely impact human health. The seeds and seed products of three species of the legume *Lathyrus* have been implicated in the genesis of neurolathyrism, a profound neurological disorder characterized by progressive and irreversible spastic paralysis of the legs. Lathyrism occurs widely during famines, when *Lathyrus* seeds represent a major contribution to the diet. L- α -Amino acids that have been implicated in human neurologic disorders, notably neurolathyrism (Table 3–4) include L-homoarginine and β -N-oxalyl-L- α , β -diaminopropionic acid (β -ODAP). The seeds of the “sweet pea,” a *Lathyrus* legume that is widely consumed during famines, contain the osteolathrogen γ -glutamyl- β -aminopropionitrile (BAPN), a glutamine derivative of β -aminopropionitrile (structure not shown). The seeds of certain *Lathyrus* species also contain α , γ -diaminobutyric acid, an analog of ornithine, that inhibits the hepatic urea cycle enzyme ornithine transcarbamoylase. The resulting disruption of the urea cycle leads to ammonia toxicity. Finally, L- β -methylaminoalanine, a neurotoxic amino acid present in *Cycad* seeds, has been

TABLE 3–4 Potentially Toxic L- α -Amino Acids

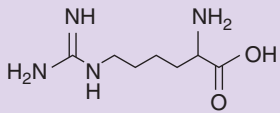
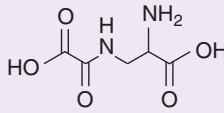
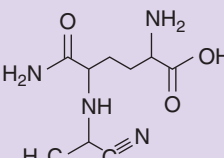
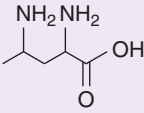
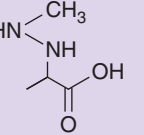
Nonprotein L- α -Amino Acid	Medical Relevance
 <p>Homoarginine</p>	Cleaved by arginase to L-lysine and urea. Implicated in human neurolathyrism.
 <p>β-N-Oxalyl diaminopropionic acid (β-ODAP)</p>	A neurotoxin. Implicated in human neurolathyrism.
 <p>β-N-Glutamylamino-propionitrile (BAPN)</p>	An osteolathrogen.
 <p>2,4-Diaminobutyric acid</p>	Inhibits ornithine transcarbamylase, resulting in ammonia toxicity.
 <p>β-Methylaminoalanine</p>	Possible risk factor for neurodegenerative diseases.

implicated as a risk factor for neurodegenerative diseases including amyotrophic lateral sclerosis-Parkinson dementia complex in natives of Guam who consume either fruit bats that feed on cycad fruit, or flour made from cycad seeds.

D-Amino Acids

D-Amino acids that occur naturally include free D-serine and D-aspartate in brain tissue, D-alanine and D-glutamate in the cell walls of gram-positive bacteria, and D-amino acids in certain peptides and antibiotics produced by bacteria, fungi, reptiles, and other nonmammalian species. *Bacillus subtilis* excretes D-methionine, D-tyrosine, D-leucine, and D-tryptophan to trigger biofilm disassembly, and *Vibrio cholerae* incorporates D-leucine and D-methionine into the peptide component of their peptidoglycan layer.

PROPERTIES OF THE FUNCTIONAL GROUPS OF AMINO ACIDS

Amino Acids May Have Positive, Negative, or Zero Net Charge

In aqueous solution, the charged and uncharged forms of the ionizable weak acid groups —COOH and —NH_3^+ exist in dynamic protonic equilibrium:

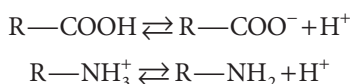

While both R—COOH and R—NH_3^+ are weak acids, R—COOH is a far stronger acid than R—NH_3^+ . Thus, at physiologic pH (pH 7.4), carboxyl groups exist almost entirely as R—COO^- and amino groups predominantly as R—NH_3^+ . The imidazole group of histidine and the guanidino group of arginine exist as resonance hybrids with positive charge distributed between two nitrogens (histidine) or three nitrogens (arginine) (Figure 3–4). Figures 3–5 and 3–6 illustrate the effect that the pH of the aqueous environment has on the charged state of aspartic acid and lysine, respectively.

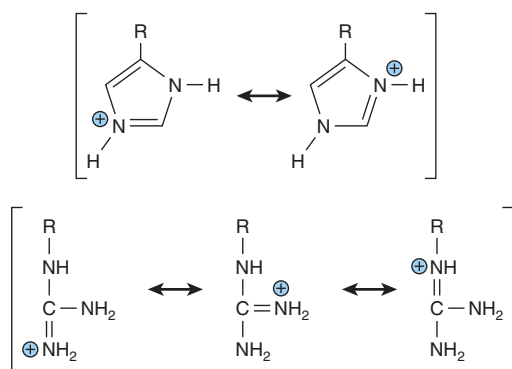
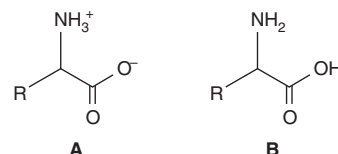

FIGURE 3–4 Resonance hybrids of the protonated R groups of histidine (TOP) and arginine (BOTTOM).

Molecules that contain an equal number of positively- and negatively-charged groups bear no *net* charge. These ionized neutral species are termed **zwitterions**. Amino acids in blood and most tissues thus should be represented as in **A**, below.



Structure **B** cannot exist in aqueous solution because at any pH low enough to protonate the carboxyl group, the amino group would also be protonated. Similarly, at any pH sufficiently high for an uncharged amino group to predominate, a carboxyl group will be present as R—COO^- . The uncharged representation **B** is, however, often used when diagramming reactions that do not involve protonic equilibria.

pK_a Values Express the Strengths of Weak Acids

The strengths of weak acids are expressed as their **pK_a**. For molecules with multiple dissociable protons, the pK_a for each acidic group is designated by replacing the subscript “a” with a number. The net charge on an amino acid—the algebraic sum of all the positively and negatively charged groups present—depends upon the pK_a values of its functional groups and the pH of the surrounding medium. In the laboratory, altering the charge on amino acids and their derivatives by varying the pH facilitates the physical separation of amino acids, peptides, and proteins (see Chapter 4).

At Its Isoelectric pH (pI), an Amino Acid Bears No Net Charge

Zwitterions are one example of an **isoelectric** species—the form of a molecule that has an equal number of positive and negative charges and thus is electrically neutral. The isoelectric pH, also called the pI, is the pH midway between pK_a values for the ionizations on either side of the isoelectric species. For an amino acid such as alanine that has only two dissociating groups, there is no ambiguity. The first pK_a (R—COOH) is 2.35 and the second pK_a (R—NH_3^+) is 9.69. The isoelectric pH (pI) of alanine thus is

$$\text{pI} = \frac{\text{pK}_1 + \text{pK}_2}{2} = \frac{2.35 + 9.69}{2} = 6.02$$

For polyprotic acids, pI is also the pH midway between the pK_a values on either side of the isoelectric species. For example, the pI for aspartic acid is

$$\text{pI} = \frac{\text{pK}_1 + \text{pK}_2}{2} = \frac{2.09 + 3.96}{2} = 3.02$$

For lysine, pI is calculated from:

$$\text{pI} = \frac{\text{pK}_2 + \text{pK}_3}{2}$$

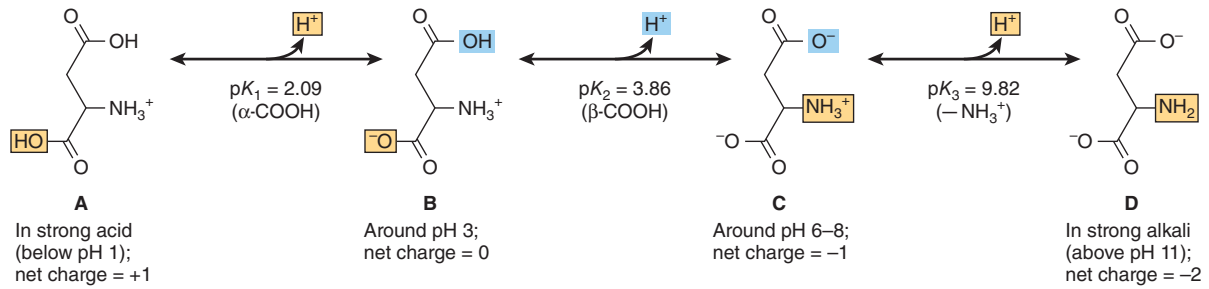

FIGURE 3–5 Protonic equilibria of aspartic acid.

Similar considerations apply to all polyprotic acids (eg, proteins), regardless of the number of dissociable groups present. In the clinical laboratory, knowledge of the pI guides selection of conditions for electrophoretic separations. For example, two simple amino acids (with one COOH and one NH_3^+ group) can be separated by electrophoresis either at an acidic or basic pH that exploits subtle differences in net charge based on subtle differences in pK_1 or pK_2 values. Similar considerations apply to understanding chromatographic separations on ionic supports such as diethylaminoethyl (DEAE) cellulose (see Chapter 4).

pK_a Values Vary With the Environment

The environment of a dissociable group affects its pK_a (Table 3–5). A nonpolar environment, which possesses less capacity than water for stabilizing charged species, thus raises the pK_a of a carboxyl group making it a weaker acid, but lowers the pK_a of an amino group, making it a stronger acid. Similarly, the presence of an adjacent *oppositely* charged group can stabilize, or of a *similarly* charged group can destabilize, a developing charge. Therefore, the pK_a values of the R groups of free amino acids in aqueous solution (see Table 3–1) provide only an approximate guide to their pK_a values when present in proteins. The pK_a of an amino acid's side chain thus will depend upon its location within a given protein. pK_a values that diverge from aqueous solution by as much as 3 pH units are common at the active sites of enzymes. An extreme example, a buried aspartic acid of thioredoxin, has a pK_a above 9—a shift of more than 6 pH units!

TABLE 3–5 Typical Range of pK_a Values for Ionizable Groups in Proteins

Dissociating Group	pK_a Range
α -Carboxyl	3.5–4.0
Non- α COOH of Asp or Glu	4.0–4.8
Imidazole of His	6.5–7.4
SH of Cys	8.5–9.0
OH of Tyr	9.5–10.5
α -Amino	8.0–9.0
ϵ -Amino of Lys	9.8–10.4
Guanidinium of Arg	~12.0

The Solubility of Amino Acids Reflects Their Ionic Character

The charges conferred by the dissociable functional groups of amino acids ensure that they are readily solvated by—and thus soluble in—polar solvents such as water and ethanol but insoluble in nonpolar solvents such as benzene, hexane, or ether.

Amino acids do not absorb visible light and thus are colorless. However, tyrosine, phenylalanine, and especially tryptophan absorb high-wavelength (250–290 nm) ultraviolet light. Because it absorbs ultraviolet light about ten times more efficiently than either phenylalanine or tyrosine, tryptophan

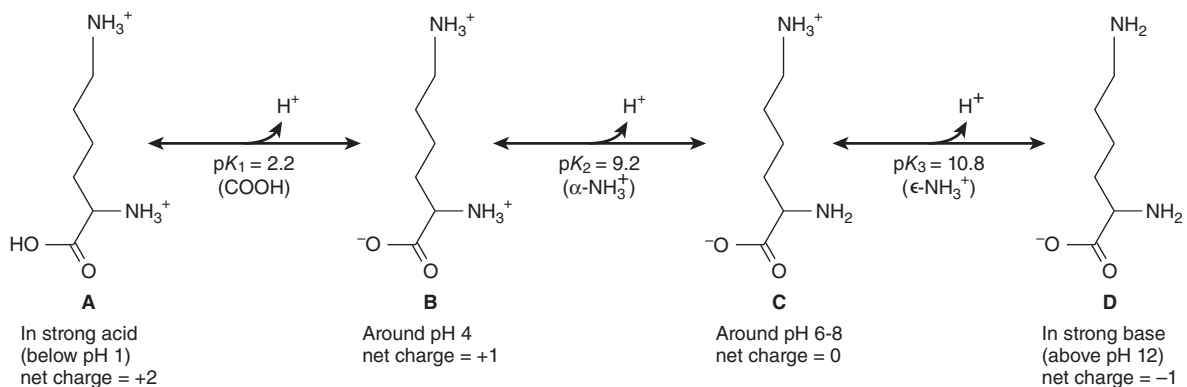

FIGURE 3–6 Protonic equilibria of lysine.

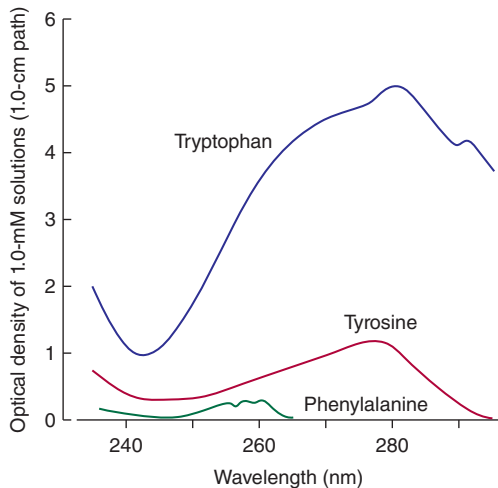

FIGURE 3-7 Ultraviolet absorption spectra of tryptophan, tyrosine, and phenylalanine.

makes the major contribution to the ability of most proteins to absorb light in the region of 280 nm (Figure 3-7).

THE α -R GROUPS DETERMINE THE PROPERTIES OF AMINO ACIDS

Each functional group of an amino acid exhibits all of its characteristic chemical reactions. For carboxylic acid groups, these reactions include the formation of esters, amides, and acid anhydrides; for amino groups, acylation, amidation, and esterification; and for $-\text{OH}$ and $-\text{SH}$ groups, oxidation and esterification. Since glycine, the smallest amino acid, can be accommodated in places inaccessible to other amino acids, it often occurs where peptides bend sharply. The hydrophobic R groups of alanine, valine, leucine, and isoleucine and the aromatic R groups of phenylalanine, tyrosine, and tryptophan typically occur primarily in the interior of cytosolic proteins. The charged R groups of basic and acidic amino acids stabilize specific protein conformations via ionic interactions, or salt bridges. These interactions also function in “charge relay” systems during enzymatic catalysis and electron transport in respiring mitochondria. Histidine plays unique roles in enzymatic catalysis. The $\text{p}K_a$ of its imidazole proton permits histidine to function at neutral pH as either a base or an acid catalyst without the need for any environmentally induced shift. The primary alcohol group of serine and the primary thioalcohol ($-\text{SH}$) group of cysteine are excellent nucleophiles, and can function as such during enzymatic catalysis. The $\text{p}K_a$ of selenocysteine, 5.2, is 3 units lower than that of cysteine, so that it should, in principle, be the better nucleophile. However, the secondary alcohol group of threonine, while a good nucleophile, is not known to fulfill an analogous role in catalysis. The $-\text{OH}$ groups of serine, tyrosine, and threonine frequently serve as the points of covalent attachment for phosphoryl groups that regulate protein function (see Chapter 9).

Amino Acid Sequence Determines Primary Structure

Amino acids are linked together by peptide bonds.

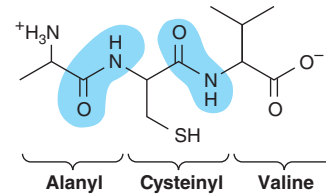

The number and order of the amino acid residues in a polypeptide constitute its primary structure. Amino acids present in peptides are called aminoacyl residues, and are referred to by replacing the *-ate* or *-ine* suffixes of free amino acids with *-yl* (eg, alanyl, aspartyl, tyrosyl). Peptides are then named as derivatives of the *carboxy* terminal aminoacyl residue. For example, Lys-Leu-Tyr-Gln is called lysyl-leucyl-tyrosyl-glutamine. The *-ine* ending on the carboxy-terminal residue (eg, glutamine) indicates that its α -carboxyl group is *not* involved in a peptide bond. Three-letter abbreviations linked by straight lines represent an unambiguous primary structure. Lines are omitted when using single-letter abbreviations.

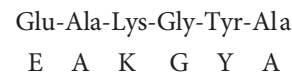

Prefixes like *tri-* or *octa-* denote peptides with three or eight **residues**, respectively. By convention, peptides are written with the residue that bears the free α -amino group at the left. This convention was adopted long before it was discovered that peptides are synthesized *in vivo* starting from the amino-terminal residue.

Peptide Structures Are Easy to Draw

To draw a peptide, use a zigzag to represent the main chain or backbone. Add the main chain atoms, which occur in the repeating order: α -nitrogen, α -carbon, carbonyl carbon. Now add a hydrogen atom to each α -carbon and to each peptide nitrogen, and an oxygen to the carbonyl carbon. Finally, add the appropriate R groups (shaded) to each α -carbon atom.

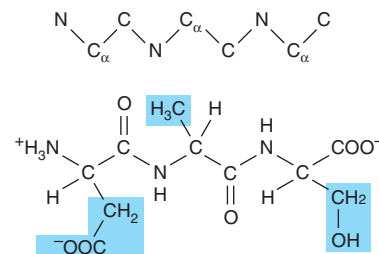

Some Peptides Contain Unusual Amino Acids

In mammals, peptide hormones typically contain only the 20 codon-specified α -amino acids linked by standard peptide bonds. Other peptides may, however, contain nonprotein

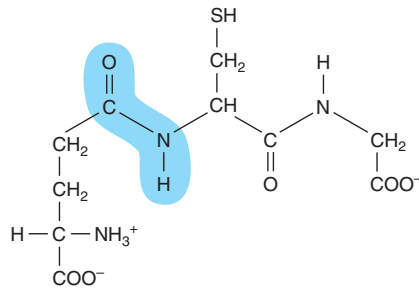
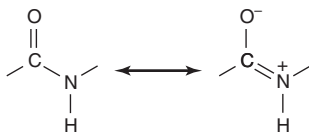

FIGURE 3-8 Glutathione (γ -glutamyl-cysteinyl-glycine). Note the non- α peptide bond that links Glu to Cys.

amino acids, derivatives of the protein amino acids, or amino acids linked by an atypical peptide bond. For example, the amino terminal glutamate of glutathione, a tripeptide that participates in the metabolism of xenobiotics (see Chapter 47) and the reduction of disulfide bonds, is linked to cysteine by a non- α peptide bond (Figure 3-8). The amino terminal glutamate of thyrotropin-releasing hormone (TRH) is cyclized to pyroglutamic acid, and the carboxyl group of the carboxyl terminal prolyl residue is amidated. The nonprotein amino acids *D*-phenylalanine and ornithine are present in the cyclic peptide antibiotics tyrocidin and gramicidin S, while the heptapeptide opioids dermorphin and deltorphin in the skin of South American tree frogs contain *D*-tyrosine and *D*-alanine.

The Peptide Bond Has Partial Double-Bond Character

Although peptide structures are written as if a single bond linked the α -carboxyl and α -nitrogen atoms, this bond in fact exhibits partial double-bond character:



Hence, the bond that connects a carbonyl carbon to an α -nitrogen cannot rotate, as this would require breaking the partial double bond. Therefore, the O, C, N, and H atoms of a peptide bond are coplanar. The imposed semirigidity of the peptide bond has important consequences for the manner in which peptides and proteins fold to generate higher orders of structure. Encircling brown arrows indicate free rotation about the remaining bonds of the polypeptide backbone (Figure 3-9).

Noncovalent Forces Constrain Peptide Conformations

Folding of a peptide probably occurs coincident with its biosynthesis (see Chapter 37). The mature, physiologically active conformation reflects the collective contributions of the amino acid sequence, noncovalent interactions (eg, hydrogen bonding, hydrophobic interactions), and the minimization of steric

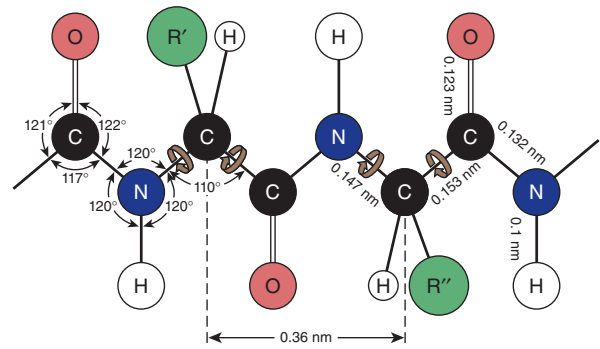

FIGURE 3-9 Dimensions of a fully extended polypeptide chain. The four atoms of the peptide bond are coplanar. Free rotation can occur about the bonds that connect the α -carbon with the α -nitrogen and with the α -carbonyl carbon (**brown arrows**). The extended polypeptide chain is thus a semirigid structure with two-thirds of the atoms of the backbone held in a fixed planar relationship one to another. The distance between adjacent α -carbon atoms is 0.36 nm (3.6 Å). The interatomic distances and bond angles, which are not equivalent, are also shown. (Redrawn and reproduced, with permission, from Pauling L, Corey LP, Branson HR: The structure of proteins: Two hydrogen-bonded helical configurations of the polypeptide chain. Proc Natl Acad Sci USA 1951;37:205.)

hindrance between residues. Common repeating conformations include α -helices and β -pleated sheets (see Chapter 5).

Peptides Are Polyelectrolytes

The peptide bond is uncharged at any pH of physiologic interest. Formation of peptides from amino acids is therefore accompanied by a net loss of one positive and one negative charge per peptide bond formed. Peptides nevertheless are charged at physiologic pH owing to their terminal carboxyl and amino groups and, where present, their acidic or basic R groups. As for amino acids, the net charge on a peptide depends on the pH of its environment and on the pK_a values of its dissociating groups.

ANALYSIS OF THE AMINO ACID CONTENT OF BIOLOGIC MATERIALS

As discussed in Chapter 4, the amino acid content of proteins generally is extrapolated from the DNA sequence of the encoding gene, or directly analyzed by mass spectrometry. The following material, while primarily of historical interest, can still find applications, for example, in the detection of abnormal quantities of urinary amino acids when modern equipment is lacking. Free amino acids released by cleavage of peptide bonds in hot hydrochloric acid can be separated and identified by high-pressure liquid chromatography (HPLC) or by paper chromatography (TLC) that employ a mobile phase composed of a mixture of miscible polar and nonpolar components (eg, *n*-butanol, formic acid, and water). As the mobile phase moves up the sheet or down a column

it becomes progressively enriched in the less polar constituents. Nonpolar amino acids (eg, Leu, Ile) therefore travel the farthest while polar amino acids (eg, Glu, Lys) travel the least distance from the origin. Amino acids can then be visualized using ninhydrin, which forms purple products with most α -amino acids but a yellow adduct with proline and hydroxyproline.

SUMMARY

- Both D-amino acids and non- α -amino acids occur in nature, but proteins are synthesized using only L- α -amino acids. D-Amino acids do, however, serve metabolic roles, not only in bacteria, but also in humans.
- L- α -Amino acids serve vital metabolic functions in addition to protein synthesis. Examples include the biosynthesis of urea, heme, nucleic acids, and hormones such as epinephrine and DOPA.
- The presence in meteorites of trace quantities of many of the protein amino acids lends credence to the hypothesis that asteroid strikes might have contributed to the development of life on earth.
- Certain of the L- α -amino acids present in plants and plant seeds can have deleterious effects on human health, for example in lathyrism.
- The R groups of amino acids determine their unique biochemical functions. Amino acids are classified as basic, acidic, aromatic, aliphatic, or sulfur-containing based on the composition and properties of their R groups.
- The partial double-bond character of the bond that links the carbonyl carbon and the nitrogen of a peptide render the four atoms of the peptide bond *coplanar*, and hence restrict the number of possible peptide conformations.
- Peptides are named for the number of amino acid residues present, and as derivatives of the carboxyl terminal residue. The primary structure of a peptide is its amino acid sequence, starting from the amino-terminal residue, a direction in which peptides actually are synthesized in vivo.

- All amino acids possess at least two weakly acidic functional groups, R—NH₃⁺ and R—COOH. Many also possess additional weakly acidic functional groups such as phenolic —OH, —SH, guanidino, or imidazole moieties.
- The pK_a values of all functional groups of an amino acid or of a peptide dictate its net charge at a given pH. pI, the isoelectric pH, is the pH at which an amino acid bears no net charge, and thus does not move in a direct current electrical field.
- The pK_a values of free amino acids at best only approximate pK_a values in a protein, which can differ widely due to the influence of the surroundings in a protein.

REFERENCES

- Bell EA: Nonprotein amino acids of plants. Significance in medicine, nutrition, and agriculture. *J Agric Food Chem* 2003;51:2854.
- Bender, DA: *Amino Acid Metabolism*, 3rd ed. Wiley, 2012.
- Burton AS, Stern JC, Elsilá JE, et al: Understanding prebiotic chemistry through the analysis of extraterrestrial amino acids and nucleobases in meteorites. *Chem Soc Rev* 2012;41:5459.
- Kolodkin-Gal I: D-Amino acids trigger biofilm disassembly. *Science* 2010;328:627.
- Kreil G: D-Amino acids in animal peptides. *Annu Rev Biochem* 1997;66:337.
- deMunck E, Muñoz-Sáez E, Miguel BG, et al: β -N-Methylamino-L-alanine causes neurological and pathological phenotypes mimicking Amyotrophic Lateral Sclerosis (ALS): The first step towards an experimental model for sporadic ALS. *Environ Toxicol Pharmacol* 2013;36:243.
- Nokihara K, Gerhardt J: Development of an improved automated gas-chromatographic chiral analysis system: application to nonnatural amino acids and natural protein hydrolysates. *Chirality* 2001;13:431.
- Papp LV: From selenium to selenoproteins: Synthesis, identity, and their role in human health. *Antioxidants Redox Signal*. 2007;9:775.
- Wilson NA et al: Aspartic acid 26 in reduced *Escherichia coli* thioredoxin has a pK_a greater than 9. *Biochemistry* 1995;34:8931.

Proteins: Determination of Primary Structure

Peter J. Kennelly, PhD & Victor W. Rodwell, PhD

OBJECTIVES

After studying this chapter, you should be able to:

- Describe multiple chromatographic methods commonly employed for the isolation of proteins from biologic materials.
- Describe how electrophoresis in polyacrylamide gels can be used to determine a protein's purity, relative mass, and isoelectric point.
- Describe the basis on which quadrupole and time-of-flight spectrophotometers determine molecular mass.
- Give three reasons why mass spectrometry (MS) has largely supplanted chemical methods for the determination of the primary structure of proteins and the detection of posttranslational modifications.
- Explain why MS can identify posttranslational modifications that are undetectable by Edman sequencing or DNA sequencing.
- Describe how DNA cloning and molecular biology made the determination of the primary structures of proteins much more rapid and efficient.
- Explain what is meant by "the proteome" and cite examples of its ultimate potential significance.
- Describe the advantages and limitations of gene chips as a tool for monitoring protein expression.
- Describe three strategies for resolving individual proteins and peptides from complex biologic samples to facilitate their identification by MS.
- Comment on the contributions of genomics, computer algorithms, and databases to the identification of the open reading frames (ORFs) that encode a given protein.

BIOMEDICAL IMPORTANCE

Proteins are physically and functionally complex macromolecules that perform multiple critically important roles. For example, an internal protein network, the cytoskeleton (see Chapter 51) maintains cellular shape and physical integrity. Actin and myosin filaments form the contractile machinery of muscle (see Chapter 51). Hemoglobin transports oxygen (see Chapter 6), while circulating antibodies defend against foreign invaders (see Chapter 52). Enzymes catalyze reactions that generate energy, synthesize and degrade biomolecules, replicate and transcribe genes, process mRNAs, etc (see Chapter 7). Receptors enable cells to sense and respond to hormones and other environmental

cues (see Chapters 41 and 42). Proteins are subject to physical and functional changes that mirror the life cycle of the organisms in which they reside. A typical protein is "born" at translation (see Chapter 37), matures through posttranslational processing events such as selective proteolysis (see Chapters 9 and 37), alternates between working and resting states through the intervention of regulatory factors (see Chapter 9), ages through oxidation, deamidation, etc (see Chapter 58), and "dies" when degraded to its component amino acids (see Chapter 29). An important goal of molecular medicine is to identify biomarkers such as proteins and/or modifications to proteins whose presence, absence, or deficiency is associated with specific physiologic states or diseases (**Figure 4-1**).

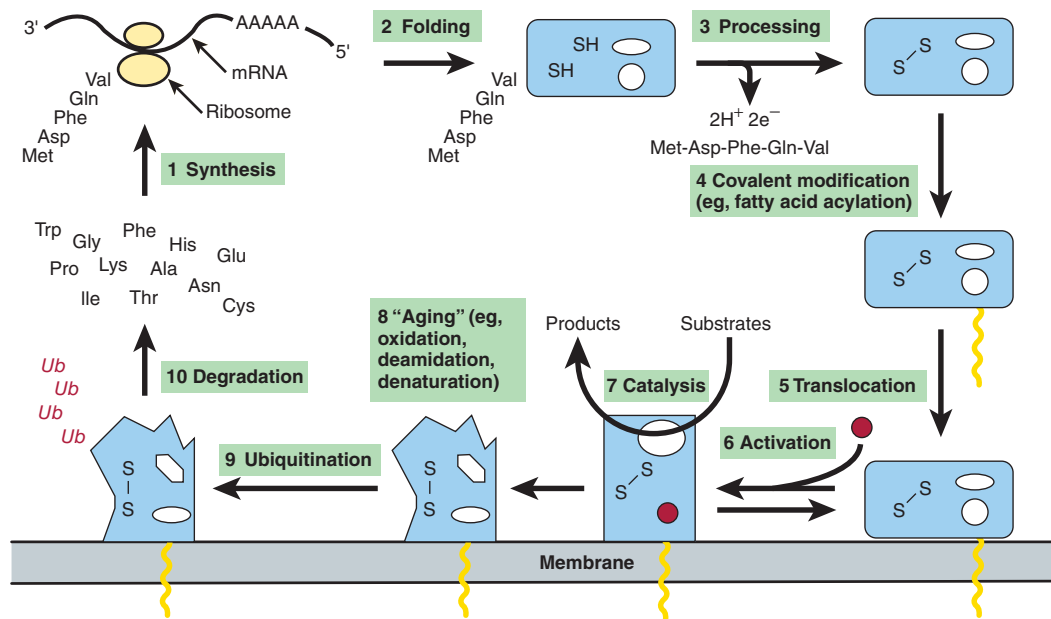

FIGURE 4-1 Diagrammatic representation of the life cycle of a hypothetical protein. (1) The life cycle begins with the synthesis on a ribosome of a polypeptide chain, whose primary structure is dictated by an mRNA. (2) As synthesis proceeds, the polypeptide begins to fold into its native conformation (blue). (3) Folding may be accompanied by processing events such as proteolytic cleavage of an *N*-terminal leader sequence (Met-Asp-Phe-Gln-Val) or the formation of disulfide bonds (S—S). (4) Subsequent covalent modifications may, for example, attach a fatty acid molecule (yellow) for (5) translocation of the modified protein to a membrane. (6) Binding an allosteric effector (red) may trigger the adoption of a catalytically active conformation. (7) Over time, proteins get damaged by chemical attack, deamidation, or denaturation, and (8) may be “labeled” by the covalent attachment of several ubiquitin molecules (*Ub*). (9) The ubiquitinated protein is subsequently degraded to its component amino acids, which become available for the synthesis of new proteins.

PROTEINS & PEPTIDES MUST BE PURIFIED PRIOR TO ANALYSIS

Highly purified protein is essential for the detailed examination of its physical and functional properties. Cells contain thousands of different proteins, each in widely varying amounts. The isolation of a specific protein in quantities sufficient for analysis of its properties thus presents a formidable challenge that may require successive application of multiple purification techniques. Selective precipitation exploits differences in relative solubility of individual proteins as a function of pH (isoelectric precipitation), polarity (precipitation with ethanol or acetone), or salt concentration (salting out with ammonium sulfate). Chromatographic techniques separate one protein from another based upon difference in their size (size exclusion chromatography), charge (ion-exchange chromatography), hydrophobicity (hydrophobic interaction chromatography), or ability to bind a specific ligand (affinity chromatography).

Column Chromatography

In column chromatography, the stationary phase matrix consists of small beads loaded into a cylindrical container of glass, plastic, or steel called a column. Liquid-permeable frits confine the beads within this space while allowing the mobile-phase

liquid to flow or percolate through the column. The stationary phase beads can be chemically derivatized to coat their surface with the acidic, basic, hydrophobic, or ligand-like groups required for ion exchange, hydrophobic interaction, or affinity chromatography. As the mobile-phase liquid emerges from the column, it is automatically collected in a series of small portions called fractions. **Figure 4-2** depicts the basic arrangement of a simple bench-top chromatography system.

HPLC—High-Pressure Liquid Chromatography

First-generation column chromatography matrices consisted of long, intertwined oligosaccharide polymers shaped into spherical beads roughly a tenth of a millimeter in diameter. Unfortunately, their relatively large size perturbed mobile-phase flow and limited the available surface area. Reducing particle size offered the potential to greatly increase resolution. However, the resistance created by the more tightly packed matrix required the use of very high pressures that would crush beads made from soft and spongy materials such as polysaccharide or acrylamide. Eventually, methods were developed to manufacture silicon particles of the necessary size and shape, to derivatize their surface with various functional groups, and to pack them into stainless steel columns capable of withstanding pressures of several thousand psi.

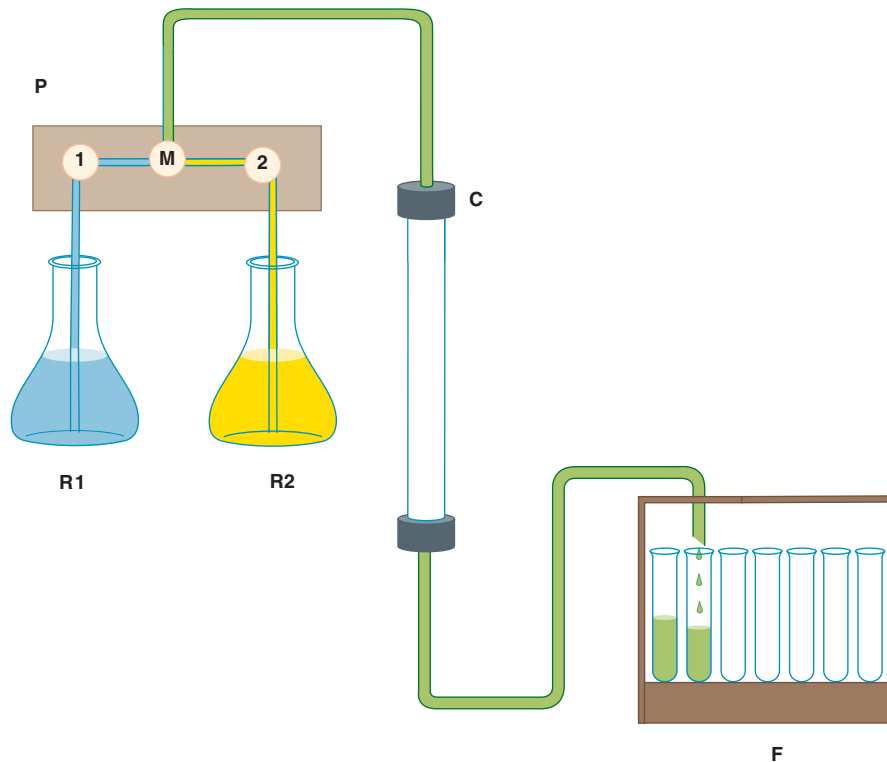

FIGURE 4–2 Components of a typical liquid chromatography apparatus. R1 and R2: Reservoirs of mobile-phase liquid. P: Programmable pumping system containing two pumps, 1 and 2, and a mixing chamber, M. The system can be set to pump liquid from only one reservoir, to switch reservoirs at some predetermined point to generate a step gradient, or to mix liquids from the two reservoirs in proportions that vary over time to create a continuous gradient. C: Glass, metal, or plastic column containing stationary phase. F: Fraction collector for collecting portions, called *fractions*, of the eluent liquid in separate test tubes.

Because of their greater resolving power, high-pressure liquid chromatography systems have largely displaced the once familiar glass columns in the protein purification laboratory.

Size-Exclusion Chromatography

Size-exclusion—or gel filtration—chromatography separates proteins based on their **Stokes radius**, the radius of the sphere they occupy as they tumble in solution. The Stokes radius is a function of molecular mass and shape. When rapidly tumbling, an elongated protein occupies a larger effective volume than a spherical protein of the same mass. Size-exclusion chromatography employs porous beads (**Figure 4–3**). The pores are analogous to indentations in a riverbank. As objects move downstream, those that enter an indentation are retarded until they drift back into the main current. Similarly, proteins with Stokes radii too large to enter the pores (excluded proteins), remain in the flowing mobile phase, and emerge *before* proteins that can enter the pores (included proteins). Proteins thus emerge from a gel filtration column in descending order of their Stokes radii.

Ion-Exchange Chromatography

In ion-exchange chromatography, proteins interact with the stationary phase by charge-charge interactions. Proteins with a net positive charge at a given pH will tightly adhere to beads

with negatively charged functional groups such as carboxylates or sulfates (cation exchangers). Similarly, proteins with a net negative charge adhere to beads with positively charged functional groups, typically tertiary or quaternary amines (anion exchangers). Nonadherent proteins flow through the matrix and are washed away. Bound proteins are then selectively displaced by gradually raising the ionic strength of the mobile phase, thereby weakening charge-charge interactions. Proteins elute in inverse order of the strength of their interactions with the stationary phase.

Hydrophobic Interaction Chromatography

Hydrophobic interaction chromatography separates proteins based on their tendency to associate with a stationary phase matrix coated with hydrophobic groups (eg, phenyl Sepharose, octyl Sephadex). Proteins with exposed hydrophobic surfaces adhere to the matrix via hydrophobic interactions that are enhanced by employing a mobile phase of high ionic strength. After nonadherent proteins are washed away, the polarity of the mobile phase is decreased by gradually lowering its salt concentration. If the interaction between protein and stationary phase is particularly strong, ethanol or glycerol may be added to the mobile phase to decrease its polarity and further weaken hydrophobic interactions.

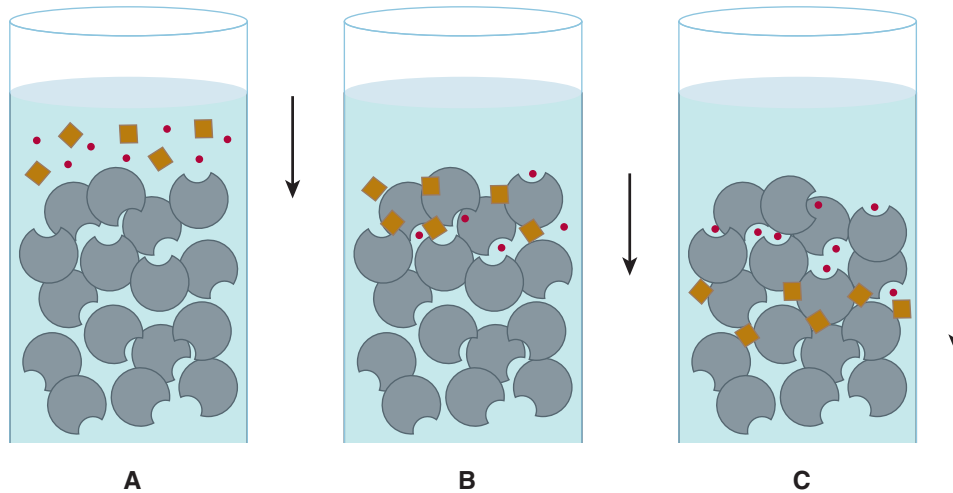

FIGURE 4-3 Size-exclusion chromatography. A: A mixture of large molecules (brown) and small molecules (red) is applied to the top of a gel filtration column. B: Upon entering the column, the small molecules enter pores in the stationary phase matrix (gray) from which the large molecules are excluded. C: As the mobile phase (blue) flows down the column, the large, excluded molecules flow with it, while the small molecules, which are temporarily sheltered from the flow when inside the pores, lag farther and farther behind.

Affinity Chromatography

Affinity chromatography exploits the high selectivity of most proteins for their ligands. Enzymes may be purified by affinity chromatography using immobilized substrates, products, coenzymes, or inhibitors. In theory, only proteins that interact with the immobilized ligand adhere. Bound proteins are then eluted either by competition with free, soluble ligand or, less selectively, by disrupting protein-ligand interactions using urea, guanidine hydrochloride, mildly acidic pH, or high salt concentrations. Commercially available stationary phase matrices contain ligands such as NAD^+ or ATP analogs. Purification of recombinantly expressed proteins is frequently facilitated by modifying the cloned gene to add a new fusion domain designed to interact with a specific matrix-bound ligand (see Chapter 7).

Protein Purity Is Assessed by Polyacrylamide Gel Electrophoresis (PAGE)

The most widely used method for determining the purity of a protein is SDS-PAGE—polyacrylamide gel electrophoresis (PAGE) in the presence of the anionic detergent sodium dodecyl sulfate (SDS). Electrophoresis separates charged biomolecules based on the rates at which they migrate in an applied electrical field. For SDS-PAGE, acrylamide is polymerized and cross-linked to form a porous matrix. SDS binds to proteins at a ratio of one molecule of SDS per two peptide bonds, causing the polypeptide to unfold or denature. When used in conjunction with 2-mercaptoethanol or dithiothreitol to reduce and break disulfide bonds (Figure 4-4), SDS-PAGE separates the component polypeptides of multimeric proteins. The large number of anionic SDS molecules, each bearing a charge of -1 , overwhelms the charge contributions of the amino acid functional

groups endogenous to the polypeptides. Since the charge-to-mass ratio of each SDS-polypeptide complex is approximately equal, the physical resistance each peptide encounters as it moves through the acrylamide matrix determines its rate of migration. Large complexes encounter greater resistance, causing polypeptides to separate based on their relative molecular mass (M_r). Individual polypeptides trapped in the acrylamide gel after removal of the electrical field are visualized by staining with dyes such as Coomassie Blue (Figure 4-5).

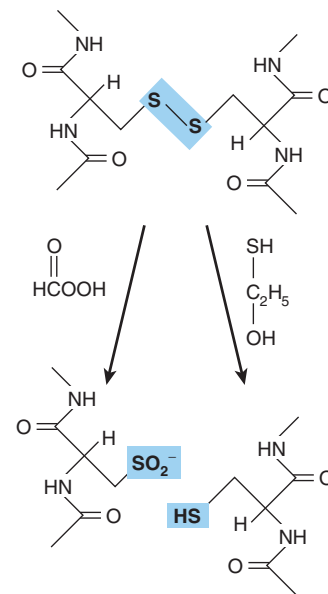

FIGURE 4-4 Oxidative cleavage of adjacent polypeptide chains linked by disulfide bonds (highlighted in blue) by performic acid (left) or reductive cleavage by β -mercaptoethanol (right) forms two peptides that contain cysteic acid residues or cysteinyl residues, respectively.

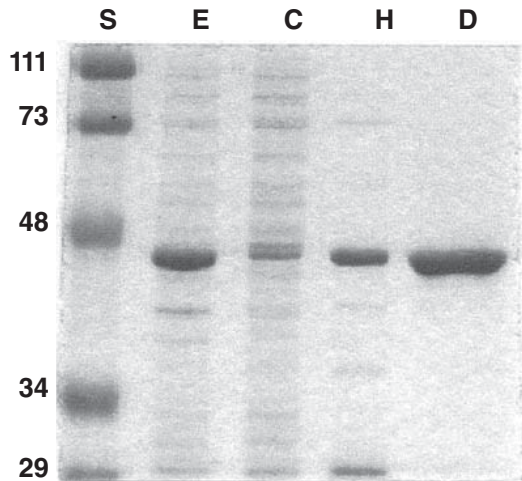

FIGURE 4-5 Use of SDS-PAGE to observe successive purification of a recombinant protein. The gel was stained with Coomassie Blue. Shown are protein standards (lane S) of the indicated M_r in kDa, crude cell extract (E), cytosol (C), high-speed supernatant liquid (H), and the DEAE-Sepharose fraction (D). The recombinant protein has a mass of about 45 kDa.

Isoelectric Focusing (IEF)

Ionic buffers called ampholytes and an applied electric field are used to generate a pH gradient within a polyacrylamide matrix. Applied proteins migrate until they reach the region of the matrix where the pH matches their isoelectric point (pI), the pH at which a molecule's net charge is 0. IEF frequently is used in conjunction with SDS-PAGE for two-dimensional electrophoresis, which separates polypeptides based on pI in one dimension and on M_r in the second (Figure 4-6). Two-dimensional electrophoresis is particularly well suited for separating the components of complex mixtures of proteins.

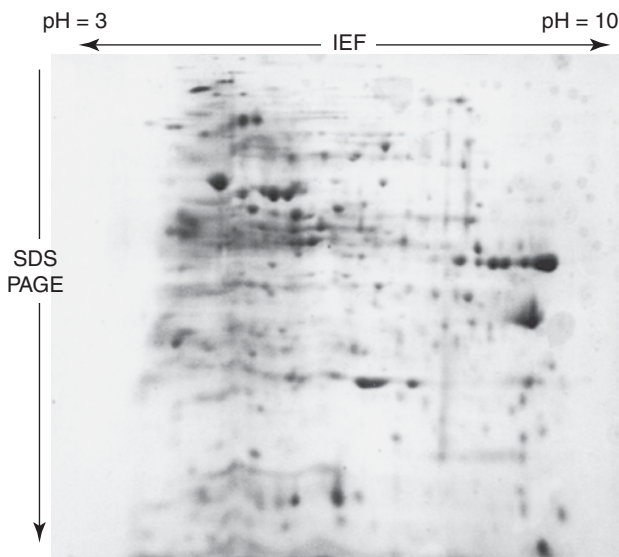

FIGURE 4-6 Two-dimensional IEF-SDS-PAGE. The gel was stained with Coomassie Blue. A crude bacterial extract was first subjected to isoelectric focusing (IEF) in a pH 3–10 gradient. The IEF gel was then placed horizontally on the top of an SDS-PAGE gel, and the proteins then further resolved by SDS-PAGE. Notice the greatly improved resolution of distinct polypeptides relative to ordinary SDS-PAGE gel (Figure 4-5).

SANGER WAS THE FIRST TO DETERMINE THE SEQUENCE OF A POLYPEPTIDE

Mature insulin consists of the 21-residue A chain and the 30-residue B chain linked by disulfide bonds. Frederick Sanger reduced the disulfide bonds (Figure 4-4), separated the A and B chains, and cleaved each chain into smaller peptides using trypsin, chymotrypsin, and pepsin. The resulting peptides were then isolated and hydrolyzed into a mixture of smaller peptides by treatment with acid. Each peptide in the mixture was isolated and treated with 1-fluoro-2,4-dinitrobenzene (Sanger reagent), which reacts with the exposed α -amino groups of the amino-terminal residues. The amino acid content of each peptide was then determined and the amino-terminal amino acid identified. The ϵ -amino group of lysine also reacts with Sanger reagent; but since an amino-terminal lysine reacts with 2 mol of Sanger reagent, it is readily distinguished from a lysine from the interior of a peptide. Working from di- and tripeptides up through progressively larger fragments, Sanger was able to reconstruct the complete sequence of insulin, an accomplishment for which he received a Nobel Prize, in 1958. Sanger, who received his second Nobel prizes for his development of techniques for DNA sequencing, died in 2013 at the age of 95.

THE EDMAN REACTION ENABLES PEPTIDES & PROTEINS TO BE SEQUENCED

Pehr Edman introduced phenylisothiocyanate (Edman reagent) to selectively label the amino-terminal residue of a peptide. In contrast to Sanger reagent, the phenylthiohydantoin (PTH) derivative can be removed under mild conditions to generate a new amino-terminal residue (Figure 4-7). Successive rounds of derivatization with Edman reagent can therefore be used to sequence many residues of a single sample of peptide. Even so, the determination of the complete sequence of a protein by chemical methods remains a time- and labor-intensive process.

The heterogeneous chemical properties of the amino acids meant that every step in the procedure represented a compromise between efficiency for any particular amino acid or set of amino acids and the flexibility needed to accommodate all 20. Consequently, each step in the process operates at less than 100% efficiency, which leads to the accumulation of polypeptide fragments with varying N -termini. Eventually, it becomes impossible to distinguish the correct PTH amino acid for that position in the peptide from the out-of-phase contaminants. As a result, the read length for Edman sequencing varies from 5 to 30 amino acid residues depending upon the quantity and purity of the peptide.

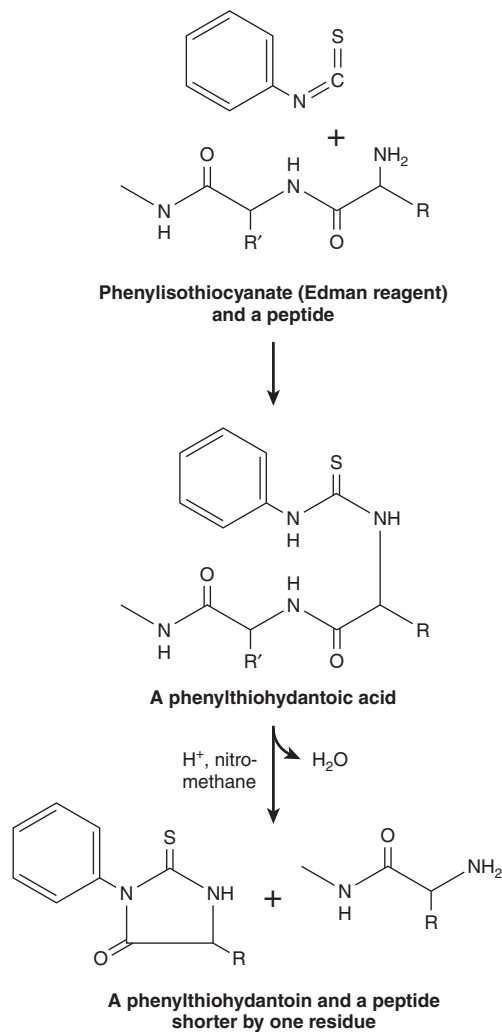

FIGURE 4-7 The Edman reaction. Phenylisothiocyanate derivatizes the amino-terminal residue of a peptide as a phenylthiohydantoin acid. Treatment with acid in a nonhydroxylic solvent releases a phenylthiohydantoin, which is subsequently identified by its chromatographic mobility, and a peptide one residue shorter. The process is then repeated.

In order to determine the complete sequence of a polypeptide several hundred residues in length, a protein must first be cleaved into smaller peptides, using either a protease or a reagent such as cyanogen bromide. Following purification by reversed phase high-pressure liquid chromatography (HPLC), these peptides are then analyzed by Edman sequencing. In order to assemble these short peptide sequences to solve the complete sequence of the intact polypeptide, it is necessary to analyze peptides whose sequences overlap one another. This is accomplished by generating multiple sets of peptides using more than one method of cleavage. The large quantities of purified protein required to test multiple protein fragmentation and peptide purification conditions constitutes the second major drawback of direct chemical protein sequencing techniques.

MOLECULAR BIOLOGY REVOLUTIONIZED THE DETERMINATION OF PRIMARY STRUCTURE

While the reactions that sequentially derivatize and cleave PTH amino acids from the amino-terminal end of a peptide typically are conducted in an automated sequenator, DNA sequencing is far more rapid and economical. Recombinant techniques permit researchers to manufacture a virtually infinite supply of DNA from even minute quantities of template present in the original sample (see Chapter 39). DNA sequencing methods, whose underlying chemistry was also developed by Sanger, routinely enable automated sequencers to “read” sequences several thousand deoxyribonucleotides in length. The sequence of the encoded polypeptide is then determined by simply translating the sequence of nucleotide triplets encoded by its gene. Conversely, early molecular biologists designed complementary oligonucleotide probes to identify the DNA clone containing the gene of interest by reversing this process and using a segment of chemically determined amino acid sequence as template. The advent of DNA cloning thus ushered in the widespread use of a hybrid approach in which Edman chemistry was employed to sequence a small portion of the protein, then exploiting this information to determine the remaining sequence by DNA cloning and poly-deoxyribonucleotide sequencing.

GENOMICS ENABLES PROTEINS TO BE IDENTIFIED FROM SMALL AMOUNTS OF SEQUENCE DATA

Today the number of organisms for which the complete DNA sequence of their genomes has been determined and made available to the scientific community numbers in the thousands (see Chapter 10). Thus, for most research scientists, particularly those working on commonly used “model organisms” such as *Homo sapiens*, mouse, rat, *Escherichia coli*, *Drosophila melanogaster*, *Caenorhabditis elegans*, yeast, etc, the sequence of the protein(s) with which they are working has already been determined and lies waiting to be accessed in a database such as GenBank (see Chapter 10). All that the scientist needs is to acquire sufficient amino acid sequence information from the protein, sometimes as little as five or six consecutive residues, to make an unambiguous identification. While the requisite amino acid sequence information can be obtained using the Edman technique, today mass spectrometry (MS) has emerged as the method of choice for protein identification.

TABLE 4-1 Mass Increases Resulting From Common Posttranslational Modifications

Modification	Mass Increase (Da)
Phosphorylation	80
Hydroxylation	16
Methylation	14
Acetylation	42
Myristylation	210
Palmitoylation	238
Glycosylation	162

MASS SPECTROMETRY CAN DETECT COVALENT MODIFICATIONS

The superior sensitivity, speed, and versatility of MS have replaced the Edman technique as the principal method for determining the sequences of peptides and proteins. MS is significantly more sensitive and tolerant of variations in sample quality. Moreover, since mass and charge are common properties of a wide range of biomolecules, MS can be used to analyze metabolites, carbohydrates, and lipids, and to detect posttranslational modifications such as phosphorylation or hydroxylation that add readily identified increments of mass to a protein (Table 4-1). These modifications are difficult to detect using the Edman technique and undetectable in the DNA-derived amino acid sequence.

MASS SPECTROMETERS COME IN VARIOUS CONFIGURATIONS

In a simple, single quadrupole mass spectrometer a sample is placed under vacuum and allowed to vaporize in the presence of a proton donor to impart a positive charge. An electrical field then propels the cations toward a curved flight tube where they encounter a magnetic field, which deflects them at a right angle to their original direction of flight (Figure 4-8). The current powering the electromagnet is gradually increased until the path of each ion is bent sufficiently to strike a detector mounted at the end of the flight tube. **For ions of identical net charge, the force required to bend their path to the same extent is proportionate to their mass.**

Time-of-flight (TOF) mass spectrometers employ a linear flight tube. Following vaporization of the sample in the presence of a proton donor, an electric field is briefly applied to accelerate the ions toward a detector at the end of the flight tube. **For molecules of identical charge, the**

velocity to which they are accelerated, and hence the time required to reach the detector, is inversely proportional to their mass.

Quadrupole mass spectrometers generally are used to determine the masses of molecules of 4000 Da or less, whereas time-of-flight mass spectrometers are used to determine the large masses of complete proteins. Various combinations of multiple quadrupoles, or reflection of ions back down the linear flight tube of a TOF mass spectrometer, are used to create more sophisticated instruments.

Peptides Can Be Volatilized for Analysis by Electrospray Ionization or Matrix-Assisted Laser Desorption

The analysis of peptides and proteins by mass spectrometry initially was hindered by difficulties in volatilizing large organic molecules. While small organic molecules could be readily vaporized by heating in a vacuum (Figure 4-9), proteins, oligonucleotides, etc. were destroyed under these conditions. Only when reliable techniques were devised for dispersing peptides, proteins, and other large biomolecules into the vapor phase was it possible to apply MS for their structural analysis and sequence determination. Three commonly used methods for dispersion into the vapor phase are **electrospray ionization**, **matrix-assisted laser desorption and ionization (MALDI)**, and **fast atom bombardment (FAB)**. In electrospray ionization, the molecules to be analyzed are dissolved in a volatile solvent and introduced into the sample chamber in a minute stream through a capillary (Figure 4-9). As the droplet of liquid emerges into the sample chamber, the solvent rapidly disperses leaving the macromolecule suspended in the gaseous phase. The charged probe serves to ionize the sample. Electrospray ionization is frequently used to analyze peptides and proteins as they elute from an HPLC or other chromatography column already dissolved in a volatile solvent. In MALDI, the sample is mixed with a liquid matrix containing a light-absorbing dye and a source of protons. In the sample chamber, the mixture is excited using a laser, causing the surrounding matrix to disperse into the vapor phase so rapidly as to avoid heating embedded peptides or proteins (Figure 4-9). In fast atom bombardment, large macromolecules dispersed in glycerol or another protonic matrix are bombarded by a stream of neutral atoms, eg, xenon, that have been accelerated to a high velocity. “Soft” ionization by FAB is frequently applied to volatilize large macromolecules intact.

Peptides inside the mass spectrometer can be broken down into smaller units by collisions with neutral helium or argon atoms (collision-induced dissociation) and the masses of the individual fragments determined. Since peptide bonds are much more labile than carbon-carbon bonds, the most abundant fragments will differ from one another by units equivalent to one or two amino acids. Since—with the exceptions of (1) leucine and isoleucine and (2) glutamine and

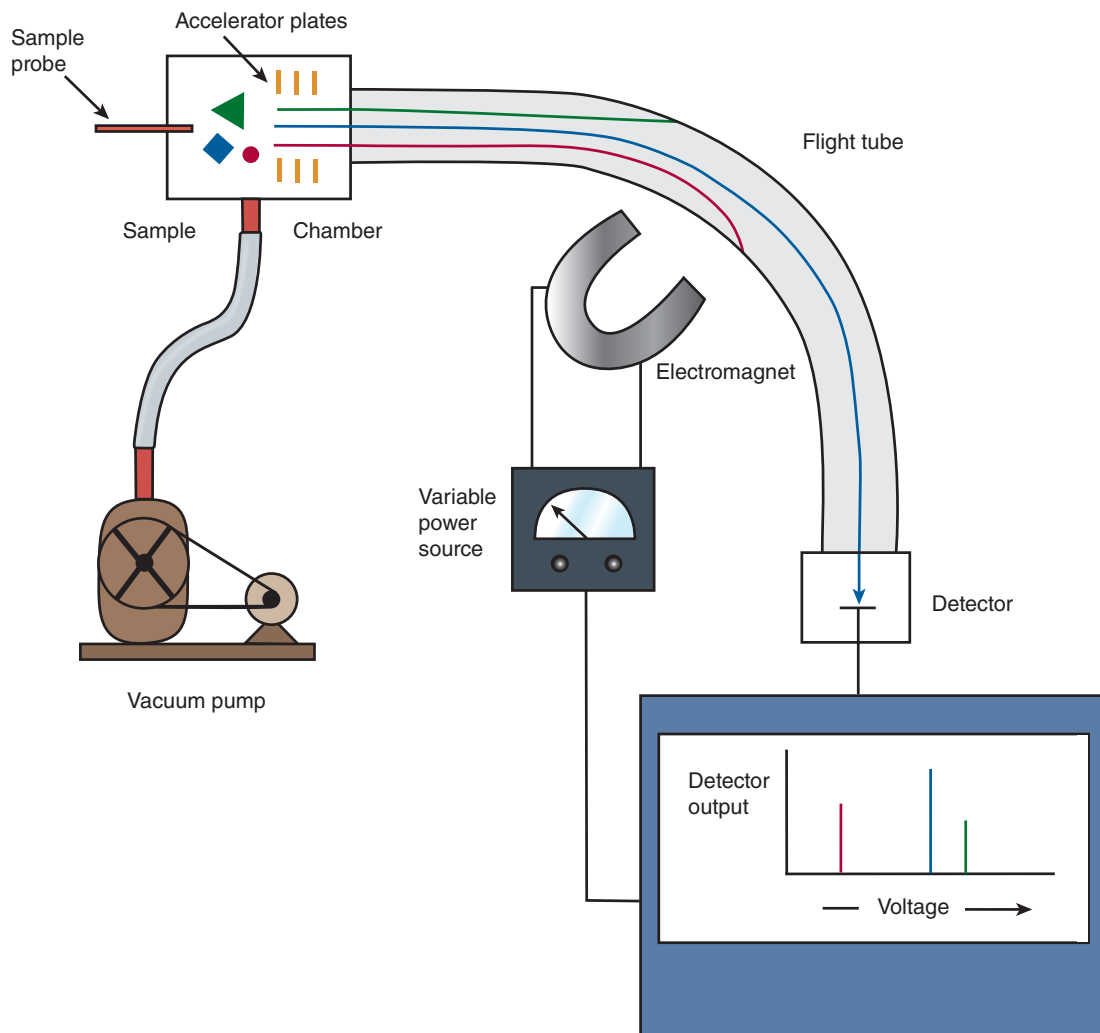

FIGURE 4-8 Basic components of a simple mass spectrometer. A mixture of molecules, represented by a red circle, green triangle, and blue diamond, is vaporized in an ionized state in the sample chamber. These molecules are then accelerated down the flight tube by an electrical potential applied to the accelerator grid (yellow). An adjustable field strength electromagnet applies a magnetic field that deflects the flight of the individual ions until they strike the detector. The greater the mass of the ion, the higher the magnetic field required to focus it onto the detector.

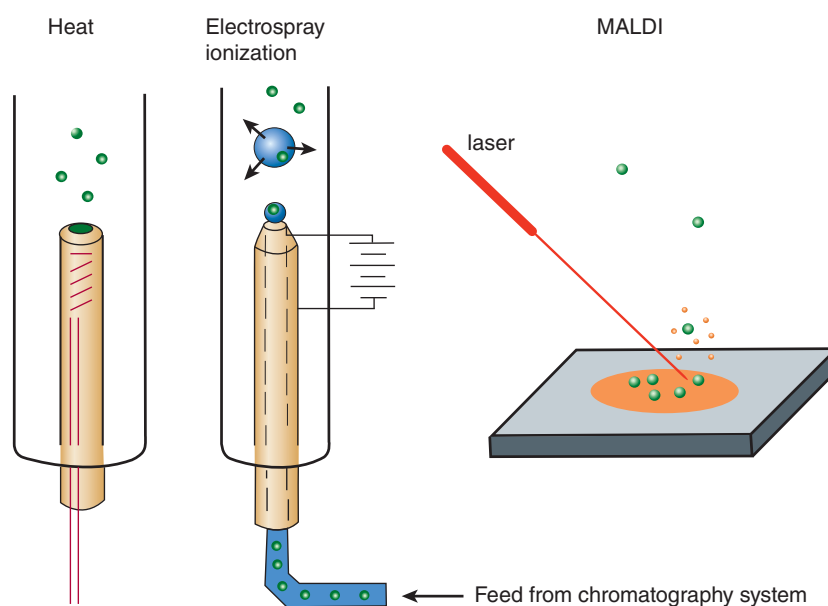

FIGURE 4-9 Three common methods for vaporizing molecules in the sample chamber of a mass spectrometer.

lysine—the molecular mass of each amino acid is unique, the sequence of the peptide can be reconstructed from the masses of its fragments.

Tandem Mass Spectrometry

Complex peptide mixtures can be analyzed, without prior purification, by tandem MS, which employs the equivalent of two mass spectrometers linked in series. For this reason, analysis by tandem instruments is often referred to as **MS–MS**, or **MS²**. The first mass spectrometer separates individual peptides based upon their differences in mass. By adjusting the field strength of the first magnet, a single peptide can be directed into the second mass spectrometer, where fragments are generated and their masses determined. Alternatively, they can be held in an electromagnetic **ion trap** located between the two quadrupoles and selectively delivered to the second quadrupole instead of being lost when the first quadrupole is set to select ions of a different mass.

Tandem MS can be used to screen blood samples from newborns for the presence and concentrations of amino acids, fatty acids, and other metabolites. Abnormalities in metabolite levels can serve as diagnostic indicators for a variety of genetic disorders, such as phenylketonuria, ethylmalonic encephalopathy, and glutaric acidemia type 1.

PROTEOMICS & THE PROTEOME

The Goal of Proteomics Is to Identify the Entire Complement of Proteins Elaborated by a Cell Under Diverse Conditions

While the sequence of the human genome is known, the picture provided by genomics alone is both static and incomplete. As genes are switched on and off, proteins are synthesized in particular cell types at specific times of growth or differentiation and in response to external stimuli. Muscle cells express proteins not expressed by neural cells, and the type of subunits present in the hemoglobin tetramer undergo change pre- and postpartum. Many proteins undergo posttranslational modifications during maturation into functionally competent forms or as a means of regulating their properties. Knowledge of the human genome therefore represents only the beginning of the task of describing living organisms in molecular detail and understanding the dynamics of processes such as growth, aging, and disease. As the human body contains thousands of cell types, each containing thousands of proteins, the **proteome**—the set of all the proteins expressed by an individual cell at a particular time—represents a moving target of formidable dimensions. Knowledge of the human genome therefore represents only the beginning of the task of describing living organisms in molecular detail and understanding the dynamics of processes such as growth, aging, and disease.

Simultaneous Determination of Hundreds of Proteins Is Technically Challenging

One goal of proteomics is the identification of proteins whose levels of expression correlate with medically significant events. The presumption is that proteins whose appearance or disappearance is associated with a specific physiologic condition or disease are linked, either directly or indirectly, to their root causes and mechanisms. While researchers had developed multiple tools for detecting and assessing the presence and quantities of selected proteins using antibodies, enzyme assays, etc, their specificity rendered them unsuitable for simultaneously determining hundreds or thousands of proteins in a typical biological sample. Assays of protein concentration, for example, by the Lowry or Bradford method, and stains such as Coomassie Blue, while universal, provide no information regarding the identity of a given polypeptide.

First generation proteomics employed SDS-PAGE or two-dimensional electrophoresis to resolve the proteins in a biologic sample one from another, followed by determination of the amino acid sequence of their amino terminus by the Edman method. Identities were determined by searching available polypeptide sequences for proteins that contained a matching N-terminal sequence and were predicted to possess a similar M_r and, for 2D gels, pI.

These early efforts were constrained by the limited number of polypeptide sequences available and the difficulties in isolating polypeptides in sufficient quantities for Edman analysis from the gels. Attempts to increase resolving power and sample yield by increasing the size of the gels were only marginally successful. Eventually, the development of mass spectrometric techniques provided a means for protein sequence determination whose sensitivity was compatible with electrophoretic separation approaches.

Knowledge of the genome sequence of the organism in question greatly facilitated identification by providing a comprehensive set of DNA-encoded polypeptide sequences. It also provided the nucleotide sequence data from which to construct **gene arrays, sometimes called DNA chips**, containing hundreds of distinct oligonucleotide probes. These chips could then be used to detect the presence of mRNAs containing complementary nucleotide sequences. While changes in the expression of the mRNA encoding a protein do not necessarily reflect comparable changes in the level of the corresponding protein, gene arrays were both less technically demanding and more sensitive than first generation proteomic approaches, particularly with respect to low abundance proteins.

Second generation proteomics coupled newly developed nanoscale chromatographic techniques with mass spectrometry. The proteins in a biologic sample are first treated with a protease to hydrolyze them into smaller peptides that are then subject to reversed phase, ion-exchange, or size exclusion chromatography to apportion the vast number of peptides into smaller subsets more amenable to analysis. These subsets are analyzed by injecting the column eluent directly

into a double quadrupole or time-of-flight mass spectrometer. **Multidimensional protein identification technology (MudPIT)** employs successive rounds of chromatography to resolve the peptides produced from the digestion of a complex biologic sample into several simpler fractions that can be analyzed separately by MS.

Today, the suspension of complex peptide mixtures within the mass spectrometer itself and subsequently exporting small subsets for final analysis using ion-traps often enables even complex mixtures to be analyzed directly by MS without prior chromatographic fractionation. Efforts also continue to refine methods for analysis of mRNA and protein expression in individual cells.

Bioinformatics Assists Identification of Protein Functions

The functions of a large proportion of the proteins encoded by the human genome are presently unknown. Efforts continue to develop protein arrays or chips for directly testing the potential functions of proteins on a mass scale. However, while some protein functions are relatively easy to assay, such as protease or esterase activity, others are much less tractable. Data mining via bioinformatics permits researchers to compare amino acid sequences of unknown proteins with those whose functions have been determined. This provides a means to uncover clues to their potential properties, physiologic roles, and mechanisms of action of proteins. Algorithms exploit the tendency of nature to employ variations of a structural theme to perform similar functions in several proteins [eg, the Rossmann nucleotide binding fold to bind NAD(P)H, nuclear targeting sequences, and EF hands to bind Ca^{2+}]. These domains generally are detected in the primary structure by conservation of particular amino acids at key positions. Insights into the properties and physiologic role of a newly discovered protein thus may be inferred by comparing its primary structure with that of known proteins.

SUMMARY

- Long amino acid polymers or polypeptides constitute the basic structural unit of proteins, and the structure of a protein provides insight into how it fulfills its functions.
- Proteins undergo posttranslational alterations during their lifetime that influence their function and determine their fate.
- By generating a new amino terminus, Edman reagent permitted the determination of lengthy segments of amino acid sequence.
- Polyacrylamide gels provide a porous matrix for separating proteins on the basis of their mobility in an applied direct current electrical field.
- The nearly constant ratio at which the anionic detergent SDS binds proteins enables SDS-PAGE to separate polypeptides predominantly on the basis of relative size.
- Because mass is a universal property of all biomolecules and their derivatives, MS has emerged as a versatile technique applicable to the determination of primary structure, identification of posttranslational modifications, and the detection of metabolic abnormalities.
- DNA cloning coupled with protein chemistry provided a hybrid approach that greatly increased the speed and efficiency for determination of primary structures of proteins.
- Genomics, the determination of entire polynucleotide sequences, provides researchers with a blueprint for every genetically encoded macromolecule in an organism.
- Proteomic analysis utilizes genomic data to identify the entire complement of proteins in a biologic sample from partial amino acid sequence data obtained by coupling protein and peptide separation methods with sequencing by MS.
- A major goal of proteomics is the identification of proteins and of their posttranslational modifications whose appearance or disappearance correlates with physiologic phenomena, aging, or specific diseases.
- Bioinformatics refers to the development of computer algorithms designed to infer the functional properties of macromolecules through comparison of sequences of novel proteins with others whose properties are known.

REFERENCES

- Anderson L: Six decades searching for meaning in the proteome. *J Proteomics* 2014;107:24.
- Barderas MG, Laborde CM, Posada M, et al: Metabolomic profiling for identification of novel potential biomarkers in cardiovascular diseases. *J Biomed Biotechnol* 2011;2011:790132.
- Biemann K: Laying the groundwork for proteomics: Mass spectrometry from 1958 to 1988. *J Proteomics* 2014;107:62.
- Brady PD, Vermeesch JR: Genomic microarrays: A technology overview. *Prenat Diagn* 2012;32:336.
- Deutscher MP (editor): *Guide to Protein Purification*. *Methods Enzymol*, vol. 182, Academic Press, 1990 (Entire volume).
- Ghafourian S, Sekawi Z, Raftari M, et al: Application of proteomics in lab diagnosis. *Clin Lab* 2013;59:465.
- Gorreta F, Carbone W, Barzaghi D: Genomic profiling: cDNA arrays and oligoarrays. *Methods Mol Biol* 2012;823:89.
- LaBorde CM, Mourino-Alvarez L, Akerstrom E, et al: Potential blood biomarkers for stroke. *Expert Rev Proteomics* 2012;9:437.
- Levy PA: An overview of newborn screening. *J Dev Behav Pediatr* 2010;31:622.
- Loewenstein Y, Raimondo D, Redfern OC, et al: Protein function annotation by homology-based inference. *Genome Biol* 2009;10:207.
- Ruhaak LR, Miyamoro S, Lebrilla CB: Developments in the identification of glycan biomarkers for the detection of cancer. *Mol Cell Proteomics* 2013;12:846.
- Schena M, Shalon D, Davis RW, et al: Quantitative monitoring of gene expression patterns with a complementary DNA microarray. *Science* 1995;270:467.
- Scopes RK: *Protein Purification. Principles and Practice*, 3rd ed. Springer, 1994.
- Sun H, Chen GY, Yao SQ: Recent advances in microarray technologies for proteomics. *Chem Biol* 2013;20:685.

- Van Riper SK, de Jong EP, Carlis JV, et al: Mass spectrometry-based proteomics: Basic principles and emerging technologies and directions. *Adv Exp Med Biol* 2013;990:1.
- Vaudel M, Sickmann A, Martens L: Introduction to opportunities and pitfalls in functional spectrometry based proteomics. *Biochim Biophys Acta* 2014;1844:12.
- Wood DW: New trends and affinity tag designs for recombinant protein purification. *Curr Opin Struct Biol* 2014;26:54.
- Yates JR, Ruse CI, Nakochevsky A: Proteomics by mass spectrometry: Approaches, advances, and applications. *Annu Rev Biomed Eng* 2009;11:49.
- Zhu H, Qian J: Applications of functional protein microarrays in basic and clinical research. *Adv Genet* 2012;79:123.

Proteins: Higher Orders of Structure

Peter J. Kennelly, PhD & Victor W. Rodwell, PhD

OBJECTIVES

After studying this chapter, you should be able to:

- Indicate the advantages and drawbacks of several approaches to classifying proteins.
- Explain and illustrate the primary, secondary, tertiary, and quaternary structure of proteins.
- Identify the major recognized types of secondary structure and explain supersecondary motifs.
- Describe the kind and relative strengths of the forces that stabilize each order of protein structure.
- Describe the information summarized by a Ramachandran plot.
- Indicate the present state of knowledge concerning the stepwise process by which proteins are thought to attain their native conformation.
- Identify the physiologic roles in protein maturation of chaperones, protein disulfide isomerase, and peptidylproline *cis-trans* isomerase.
- Describe the principal biophysical techniques used to study tertiary and quaternary structure of proteins.
- Explain how genetic and nutritional disorders of collagen maturation illustrate the close linkage between protein structure and function.
- For the prion diseases, outline the overall events in their molecular pathology and name the life forms each affects.

BIOMEDICAL IMPORTANCE

In nature, form follows function. In order for a newly synthesized polypeptide to mature into a biologically functional protein capable of catalyzing a metabolic reaction, powering cellular motion, or forming the macromolecular rods and cables that provide structural integrity to hair, bones, tendons, and teeth, it must fold into a specific three-dimensional arrangement, or **conformation**. In addition, during maturation **posttranslational modifications** may add new chemical groups or remove transiently needed peptide segments. Genetic or nutritional deficiencies that impede protein maturation are deleterious to health. Examples of the former include Creutzfeldt-Jakob disease, scrapie, Alzheimer's disease, and bovine spongiform encephalopathy ("mad cow disease"). Examples of the latter include scurvy (ascorbic acid) and Menkes syndrome (Cu). Next generation therapeutics for hepatitis C and other viral

diseases seek to block the maturation of virally encoded proteins by inhibiting the activity of the cyclophilins, a family of peptidylprotein *cis-trans* isomerases.

CONFORMATION VERSUS CONFIGURATION

The terms configuration and conformation are often confused. **Configuration** refers to the geometric relationship between a given set of atoms, for example, those that distinguish L- from D-amino acids. Interconversion of *configurational* alternatives requires breaking (and reforming) covalent bonds. **Conformation** refers to the spatial relationship of every atom in a molecule. Interconversion between *conformers* occurs with retention of configuration, generally via rotation about single bonds.

PROTEINS WERE INITIALLY CLASSIFIED BY THEIR GROSS CHARACTERISTICS

Scientists initially approached the elucidation of structure-function relationships in proteins by separating them into classes based upon properties such as solubility, shape, or the presence of nonprotein groups. For example, the proteins that can be extracted from cells using aqueous solutions of physiologic pH and ionic strength are classified as **soluble**. Extraction of **integral membrane proteins** requires dissolution of the membrane with detergents. **Globular proteins** are compact, roughly spherical molecules that have **axial ratios** (the ratio of their shortest to longest dimensions) of not over three. Most enzymes are globular proteins. By contrast, many structural proteins adopt highly extended conformations. These **fibrous proteins** may possess axial ratios of 10 or more.

Lipoproteins and **glycoproteins** contain covalently bound lipid and carbohydrate, respectively. Myoglobin, hemoglobin, cytochromes, and many other **metalloproteins** contain tightly associated metal ions. While more precise classification schemes have emerged based upon similarity, or **homology**, in amino acid sequence and three-dimensional structure, many early classification terms remain in use.

PROTEINS ARE CONSTRUCTED USING MODULAR PRINCIPLES

Proteins perform complex physical and catalytic functions by positioning specific chemical groups in a precise three-dimensional arrangement. The polypeptide scaffold containing these groups must adopt a conformation that is both functionally efficient and physically strong. At first glance, the biosynthesis of polypeptides comprised of tens of thousands of individual atoms would appear to be extremely challenging. When one considers that a typical polypeptide can potentially adopt $\geq 10^{50}$ distinct conformations, folding into the conformation appropriate to their biologic function would appear to be even more difficult. As described in Chapters 3 and 4, synthesis of the polypeptide backbones of proteins employs a small set of common building blocks or modules, the amino acids, joined by a common linkage, the peptide bond. Similarly, a stepwise modular pathway simplifies the folding and processing of newly synthesized polypeptides into mature proteins.

FOUR ORDERS OF PROTEIN STRUCTURE

The modular nature of protein synthesis and folding are embodied in the concept of orders of protein structure: **primary structure**—the sequence of amino acids in a polypeptide chain; **secondary structure**—the folding of short (3–30 residue), contiguous segments of polypeptide into geometrically ordered

units; **tertiary structure**—the assembly of secondary structural units into larger functional units such as the mature polypeptide and its component domains; and **quaternary structure**—the number and types of polypeptide units of oligomeric proteins and their spatial arrangement.

SECONDARY STRUCTURE

Peptide Bonds Restrict Possible Secondary Conformations

Free rotation is possible about only two of the three covalent bonds of the polypeptide backbone: the bond linking the α -carbon ($C\alpha$) to the carbonyl carbon ($C=O$) and the bond linking $C\alpha$ to nitrogen (see Figure 3–9). The partial double-bond character of the peptide bond that links $C=O$ to the α -nitrogen requires that the carbonyl carbon, carbonyl oxygen, and α -nitrogen remain coplanar, thus preventing rotation. The angle about the $C\alpha-N$ bond is termed the phi (Φ) angle, and that about the $C=O-C\alpha$ bond the psi (Ψ) angle. In peptides, for amino acids other than glycine, most combinations of phi and psi angles are disallowed because of steric hindrance (**Figure 5–1**). The conformations of proline are even more restricted as its cyclic structure prevents free rotation of the $N-C\alpha$ bond.

Regions of ordered secondary structure arise when a series of aminoacyl residues adopt similar phi and psi angles. Extended segments of polypeptide (eg, loops) can possess a variety of such angles. The angles that define the two most

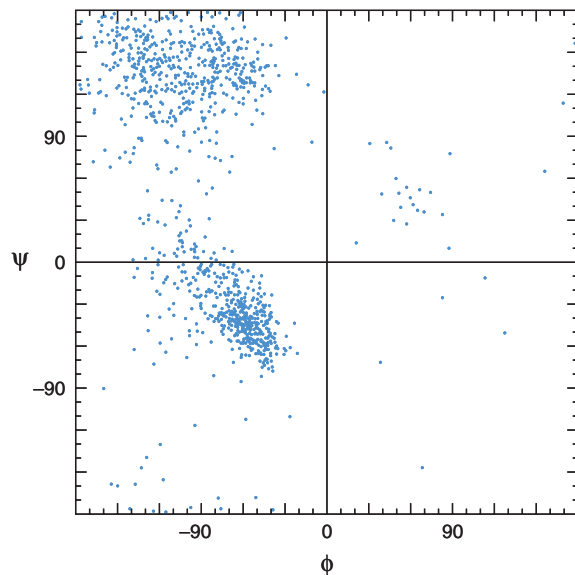

FIGURE 5–1 Ramachandran plot of the main chain phi (Φ) and psi (Ψ) angles for approximately 1000 nonglycine residues in eight proteins whose structures were solved at high resolution. The dots represent allowable combinations, and the spaces prohibited combinations, of phi and psi angles. (Reproduced, with permission, from Richardson JS: The anatomy and taxonomy of protein structures. *Adv Protein Chem* 1981;34:167. Copyright © 1981. Reprinted with permission from Elsevier.)

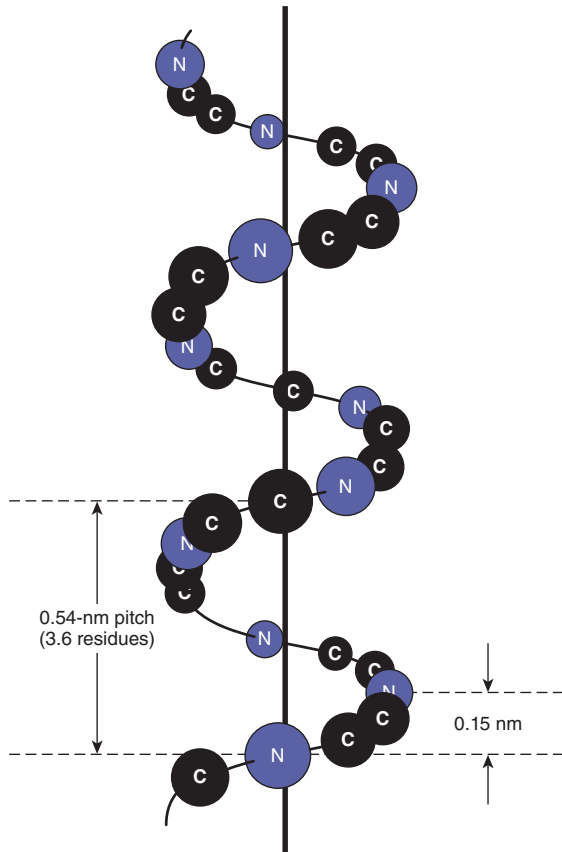

FIGURE 5-2 Orientation of the main chain atoms of a peptide about the axis of an α helix.

common types of secondary structure, the α helix and the β sheet, fall within the lower and upper left-hand quadrants of a Ramachandran plot, respectively (Figure 5-1).

Alpha Helix

The polypeptide backbone of an α helix is twisted by an equal amount about each α -carbon with a phi angle of approximately -57° and a psi angle of approximately -47° . A complete turn of the helix contains an average of 3.6 aminoacyl residues, and the distance it rises per turn (its *pitch*) is 0.54 nm (Figure 5-2). The R groups of each aminoacyl residue in an α helix face outward (Figure 5-3). Proteins contain only L-amino acids, for which a right-handed α helix is by far the more stable, and only right-handed α helices are present in proteins. Schematic diagrams of proteins represent α helices as coils or cylinders.

The stability of an α helix arises primarily from hydrogen bonds formed between the oxygen of the peptide bond carbonyl and the hydrogen atom of the peptide bond nitrogen of the fourth residue down the polypeptide chain (Figure 5-4). The ability to form the maximum number of hydrogen bonds, supplemented by van der Waals interactions in the core of this tightly packed structure, provides the thermodynamic driving force for the formation of an α helix. Since the peptide bond nitrogen of proline lacks a hydrogen atom, it is incapable of forming a hydrogen bond with a carbonyl oxygen.

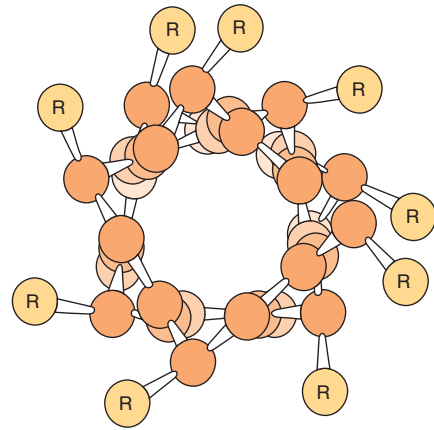

FIGURE 5-3 View down the axis of an α helix. The side chains (R) are on the outside of the helix. The van der Waals radii of the atoms are larger than shown here; hence, there is almost no free space inside the helix. (Slightly modified and reproduced, with permission, from Berg JM, Tymoczko JL, Stryer L: *Biochemistry*, 7th ed. Freeman, 2012. Copyright © 2012 W.H. Freeman and Company.)

Consequently, proline can only be stably accommodated within the first turn of an α helix. When present elsewhere, proline disrupts the conformation of the helix, producing a bend. Because it possesses such a small R group, glycine also frequently induces bends within α helices.

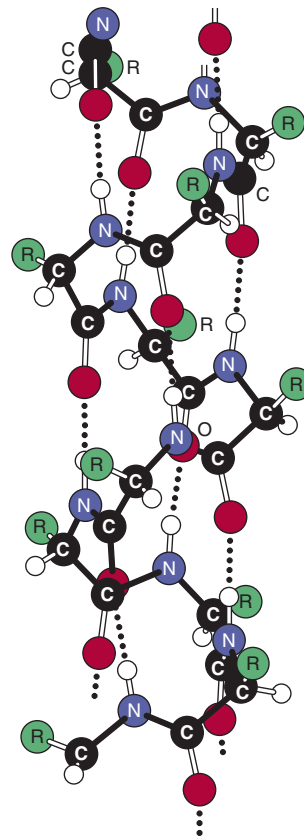

FIGURE 5-4 Hydrogen bonds (dotted lines) formed between H and O atoms stabilize a polypeptide in an α -helical conformation. (Reprinted, with permission, from Haggis GH, et al: Introduction to Molecular Biology Science 1964;146:1455–1456. Reprinted with permission from AAAS.)

Many α helices have predominantly hydrophobic R-groups projecting from one side of the axis of the helix and predominantly hydrophilic R-groups projecting from the other side. These **amphipathic helices** are well adapted to the formation of interfaces between polar and nonpolar regions such as the hydrophobic interior of a protein and its aqueous environment. Clusters of amphipathic helices can create *channels*, or pores, through hydrophobic cell membranes that permit specific polar molecules to pass.

Beta Sheet

The second (hence “beta”) recognizable regular secondary structure in proteins is the β sheet. The amino acid residues of a β sheet, when viewed edge-on, form a zigzag or pleated pattern in which the R groups of adjacent residues project in opposite directions. Unlike the compact backbone of the α helix, the peptide backbone of the β sheet is highly extended. But like the α helix, β sheets derive much of their stability from hydrogen bonds between the carbonyl oxygens and amide hydrogens of peptide bonds. However, in contrast to the α helix, these bonds are formed with adjacent segments of the β sheet (**Figure 5–5**).

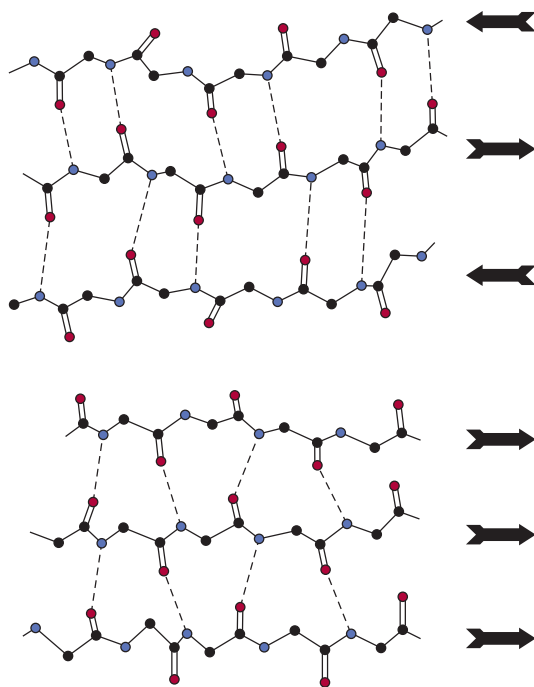

FIGURE 5–5 Spacing and bond angles of the hydrogen bonds of antiparallel and parallel pleated β sheets. Arrows indicate the direction of each strand. Hydrogen bonds are indicated by dotted lines with the participating α -nitrogen atoms (hydrogen donors) and oxygen atoms (hydrogen acceptors) shown in blue and red, respectively. Backbone carbon atoms are shown in black. For clarity in presentation, R groups and hydrogen atoms are omitted. **Top:** Antiparallel β sheet. Pairs of hydrogen bonds alternate between being close together and wide apart and are oriented approximately perpendicular to the polypeptide backbone. **Bottom:** Parallel β sheet. The hydrogen bonds are evenly spaced but slant in alternate directions.

Interacting β sheets can be arranged either to form a **parallel** β sheet, in which the adjacent segments of the polypeptide chain proceed in the same direction amino to carboxyl, or an **antiparallel** sheet, in which they proceed in opposite directions (Figure 5–5). Either configuration permits the maximum number of hydrogen bonds between segments, or strands, of the sheet. Most β sheets are not perfectly flat but tend to have a right-handed twist. Clusters of twisted strands of β sheet, sometimes referred to as β barrels, form the core of many globular proteins (**Figure 5–6**). Schematic diagrams represent β sheets as arrows that point in the amino to the carboxyl terminal direction.

Loops & Bends

Roughly half of the residues in a “typical” globular protein reside in α helices or β sheets, and half in loops, turns, bends, and other extended conformational features. Turns and bends refer to short segments of amino acids that join two units of the secondary structure, such as two adjacent strands of an antiparallel β sheet. A β turn involves four aminoacyl residues, in which the first residue is hydrogen-bonded to the fourth, resulting in a tight 180° turn (**Figure 5–7**). Proline and glycine often are present in β turns.

Loops are regions that contain residues beyond the minimum number necessary to connect adjacent regions of secondary structure. Irregular in conformation, loops nevertheless serve key biologic roles. For many enzymes, the loops that bridge domains responsible for binding substrates often contain aminoacyl residues that participate in catalysis. **Helix-loop-helix motifs** provide the oligonucleotide-binding portion of many DNA-binding proteins such as repressors and transcription factors. Structural motifs such as the helix-loop-helix motif or the E-F hands of calmodulin (see Chapter 51) that are intermediate in scale between secondary and tertiary structures are often termed **supersecondary structures**. Since many loops and bends reside on the surface of proteins, and are thus exposed to solvent, they constitute readily accessible sites, or **epitopes**, for recognition and binding of antibodies.

While loops lack apparent structural regularity, many adopt a specific conformation stabilized through hydrogen bonding, salt bridges, and hydrophobic interactions with other portions of the protein. However, not all portions of proteins are necessarily ordered. Proteins may contain “disordered” regions, often at the extreme amino or carboxyl terminal, characterized by high conformational flexibility. In many instances, these disordered regions assume an ordered conformation upon binding of a ligand. This structural flexibility enables such regions to act as ligand-controlled switches that affect protein structure and function.

Tertiary & Quaternary Structure

The term “tertiary structure” refers to the entire three-dimensional conformation of a polypeptide. It indicates, in three-dimensional space, how secondary structural features—helices, sheets, bends, turns, and loops—assemble to form domains and how these

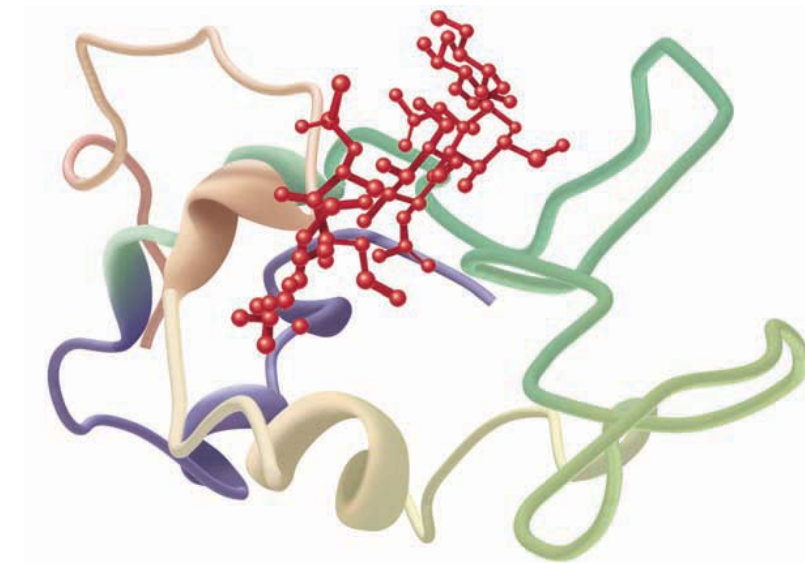
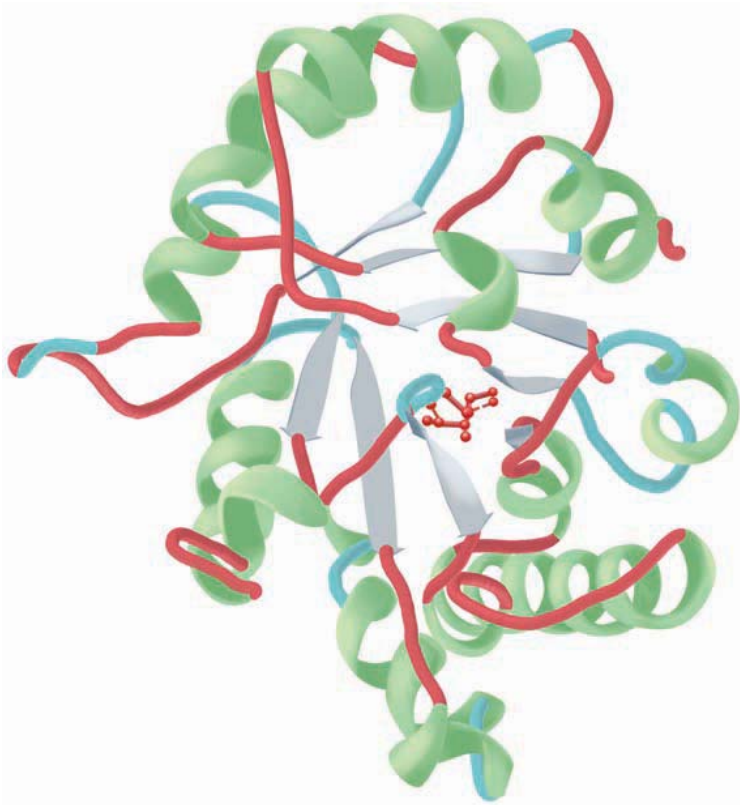

FIGURE 5-6 Examples of the tertiary structure of proteins. **Top:** The enzyme triose phosphate isomerase complexed with the substrate analog 2-phosphoglycerate (red). Note the elegant and symmetrical arrangement of alternating β sheets (light blue) and α helices (green), with the β sheets forming a β -barrel core surrounded by the helices. (Adapted from Protein Data Bank ID no. 1o5x.) **Bottom:** Lysozyme complexed with the substrate analog penta-*N*-acetyl chitopentaose (red). The color of the polypeptide chain is graded along the visible spectrum from purple (N-terminal) to tan (C-terminal). The concave shape of the domain forms a binding pocket for the pentasaccharide, the lack of β sheet, and the high proportion of loops and bends. (Adapted from Protein Data Bank ID no. 1sfb.)

domains relate spatially to one another. A **domain** is a section of the protein structure sufficient to perform a particular chemical or physical task such as binding of a substrate or other ligand. Most domains are modular in nature, and contiguous in both primary sequence and three-dimensional space (**Figure 5-8**). Simple proteins, particularly those that interact with a single substrate, such as lysozyme or triose phosphate isomerase (**Figure 5-6**) and the oxygen storage protein myoglobin (see Chapter 6), often consist of a single domain. By contrast, lactate dehydrogenase is comprised of two domains, an N-terminal NAD^+ -binding domain and a C-terminal binding domain for the second substrate, pyruvate (**Figure 5-8**).

Lactate dehydrogenase is one of the family of oxidoreductases that share a common N-terminal NAD(P)^+ -binding domain known as the **Rossmann fold**. By fusing a segment of DNA coding for a Rossmann fold domain to that coding for a variety of C-terminal domains, a large family of oxidoreductases have evolved that utilize $\text{NAD(P)}^+/\text{NAD(P)H}$ for the oxidation and reduction of a wide range of metabolites. Examples include alcohol dehydrogenase, glyceraldehyde-3-phosphate dehydrogenase, malate dehydrogenase, quinone oxidoreductase, 6-phosphogluconate dehydrogenase, *D*-glycerate dehydrogenase, formate dehydrogenase, and $3\alpha, 20\beta$ -hydroxysteroid dehydrogenase.

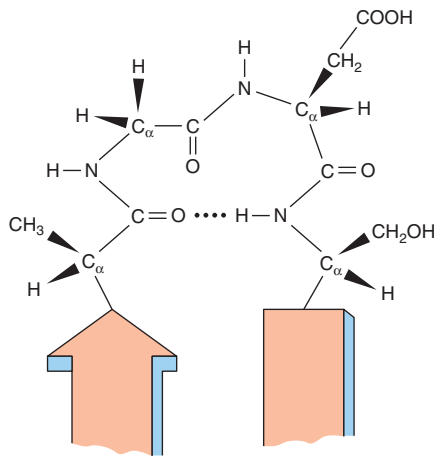

FIGURE 5-7 A β turn that links two segments of antiparallel β sheet. The dotted line indicates the hydrogen bond between the first and fourth amino acids of the four-residue segment Ala-Gly-Asp-Ser.

Not all domains bind substrates. Hydrophobic membrane domains anchor proteins to membranes or enable them to span membranes. Localization sequences target proteins to specific subcellular or extracellular locations such as the nucleus, mitochondria, secretory vesicles, etc. Regulatory domains trigger changes in protein function in response to the binding of allosteric effectors or covalent modifications (see Chapter 9). Combining the genetic material coding for individual domain modules provides a facile route for generating proteins of great structural complexity and functional sophistication (Figure 5-9).

Proteins containing multiple domains can also be assembled through the association of multiple polypeptides, or protomers. Quaternary structure defines the polypeptide composition of a protein and, for an oligomeric protein, the spatial relationships between its protomers or subunits. **Monomeric** proteins consist of a single polypeptide chain. **Dimeric** proteins contain two polypeptide chains. **Homodimers** contain two copies of the same polypeptide chain, while in a **heterodimer** the polypeptides differ. Greek letters (α , β , γ , etc) are used to distinguish different subunits of a hetero-oligomeric protein, and subscripts indicate the number of each subunit type. For example, α_4 designates a homotetrameric protein, and $\alpha_2\beta_2\gamma$, a protein with five subunits of three different types.

Since even small proteins contain many thousands of atoms, depictions of protein structure that indicate the position of every atom are generally too complex to be readily interpreted. Simplified schematic diagrams thus are used to depict the key features of a protein's tertiary and quaternary structure. Ribbon diagrams (Figures 5-6 and 5-8) trace the conformation of the polypeptide backbone, with cylinders and arrows indicating regions of α helix and β sheet, respectively. In an even simpler representation, line segments that link the α carbons of each amino acid residue indicate the path of the polypeptide backbone. In order to emphasize specific structure-function relationships, these schematic diagrams often depict the side chains of selected amino acids.

MULTIPLE FACTORS STABILIZE TERTIARY & QUATERNARY STRUCTURE

Higher orders of protein structure are stabilized primarily—and often exclusively—by noncovalent interactions. Principal among these are hydrophobic interactions that drive most hydrophobic amino acid side chains into the interior of the protein away from the surrounding water. Other significant contributors include hydrogen bonds and salt bridges between the carboxylates of aspartic and glutamic acid and the oppositely charged side chains of protonated lysyl, arginyl, and histidyl residues. These interactions are individually weak—1 to 5 kcal/mol relative to 80 to 120 kcal/mol for a covalent bond. However, just as a Velcro fastener harnesses the cumulative strength of a multitude of tiny plastic loops and hooks, collectively these individually weak but numerous interactions confer a high degree of stability to the biologically functional conformation of a protein.

Some proteins contain covalent disulfide (S—S) bonds that link the sulfhydryl groups of cysteinyl residues. Formation of disulfide bonds involves oxidation of the cysteinyl sulfhydryl groups and requires oxygen. Intrapolypeptide disulfide bonds further enhance the stability of the folded conformation of a peptide, while interpolypeptide disulfide bonds stabilize the quaternary structure of certain oligomeric proteins.

THREE-DIMENSIONAL STRUCTURE IS DETERMINED BY X-RAY CRYSTALLOGRAPHY OR BY NMR SPECTROSCOPY

X-Ray Crystallography

Following the solution of the three-dimensional structure of myoglobin by John Kendrew in 1960, x-ray crystallography has revealed the structures of thousands of biological macromolecules ranging from proteins to oligonucleotides and viruses. For the solution of its structure by x-ray crystallography, a protein is first precipitated under conditions that form well-ordered crystals. To establish appropriate conditions, crystallization trials use a few microliters of protein solution and a matrix of variables (temperature, pH, presence of salts or organic solutes such as polyethylene glycol) to establish optimal conditions for crystal formation. Crystals mounted in quartz capillaries are first irradiated with monochromatic x-rays of approximate wavelength 0.15 nm to confirm that they are protein, not salt. Protein crystals may then be frozen in liquid nitrogen for subsequent collection of a high-resolution data set. Early crystallographers collected the circular patterns formed by the diffracted x-rays on film and analyzed them by hand. Today, the patterns are recorded electronically using an area detector, then analyzed using a mathematical approach

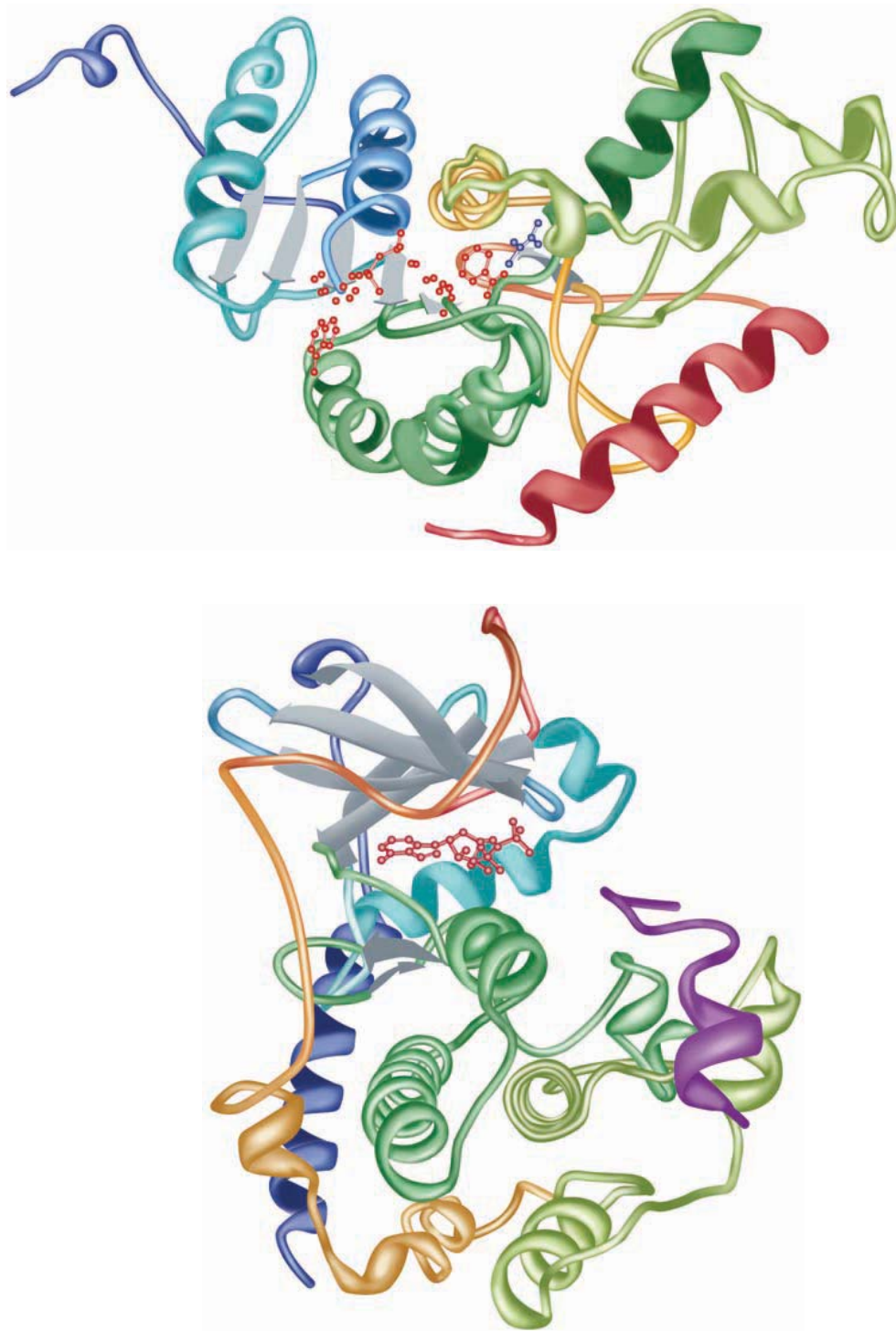

FIGURE 5-8 Polypeptides containing two domains. **Top:** Shown is the three-dimensional structure of a monomer unit of the tetrameric enzyme lactate dehydrogenase with the substrates NADH (red) and pyruvate (blue) bound. Not all bonds in NADH are shown. The color of the polypeptide chain is graded along the visible spectrum from blue (N-terminal) to orange (C-terminal). Note how the N-terminal portion of the polypeptide forms a contiguous domain, encompassing the left portion of the enzyme, responsible for binding NADH. Similarly, the C-terminal portion forms a contiguous domain responsible for binding pyruvate. (Adapted from Protein Data Bank ID no. 3ldh.) **Bottom:** Shown is the three-dimensional structure of the catalytic subunit of the cAMP-dependent protein kinase (Chapter 42) with the substrate analogs ADP (red) and peptide (purple) bound. The color of the polypeptide chain is graded along the visible spectrum from blue (N-terminal) to orange (C-terminal). Protein kinases transfer the γ -phosphate group of ATP to protein and peptide substrates (Chapter 9). Note how the N-terminal portion of the polypeptide forms a contiguous domain rich in β sheet that binds ADP. Similarly, the C-terminal portion forms a contiguous, α helix-rich domain responsible for binding the peptide substrate. (Adapted from Protein Data Bank ID no. 1jbp.)

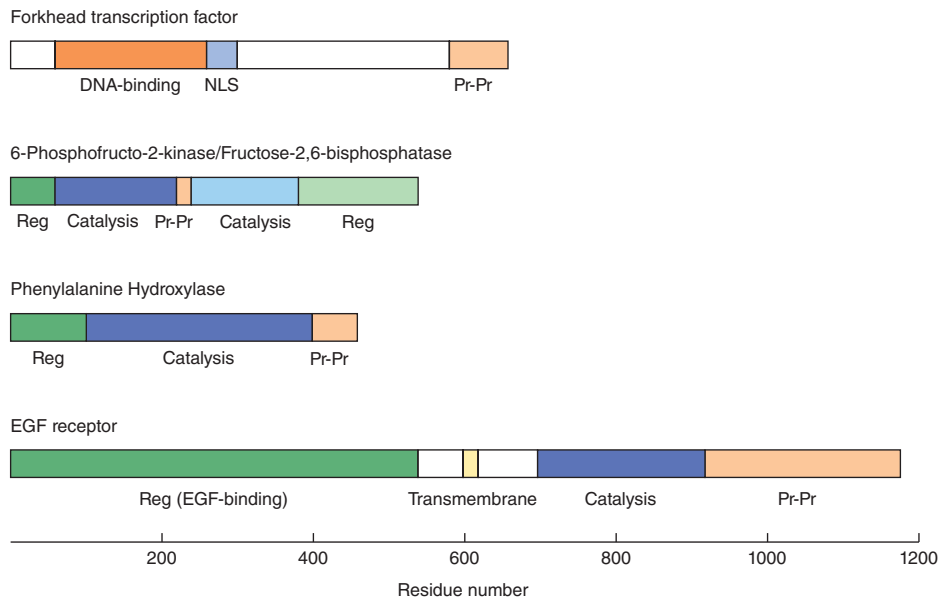

FIGURE 5-9 Some multidomain proteins. The rectangles represent the polypeptide sequences of a forkhead transcription factor; 6-phosphofructo-2-kinase/fructose-2,6-bisphosphatase, a bifunctional enzyme whose activities are controlled in a reciprocal fashion by allosteric effectors and covalent modification (see Chapter 19); phenylalanine hydroxylase (see Chapters 27 and 29), whose activity is stimulated by phosphorylation of its regulatory domain; and the epidermal growth factor (EGF) receptor (see Chapter 41), a transmembrane protein whose intracellular protein kinase domain is regulated via the binding of the peptide hormone EGF to its extracellular domain. Regulatory domains are colored green, catalytic domains dark blue and light blue, protein-protein interaction domains light orange, DNA binding domains dark orange, nuclear localization sequences medium blue, and transmembrane domains yellow. The kinase and bisphosphatase activities of 6-phosphofructo-2-kinase/fructose-2,6-bisphosphatase are catalyzed by the N- and C-terminal proximate catalytic domains, respectively.

termed a *Fourier synthesis*, which summates wave functions. The wave amplitudes are related to spot intensity, but since the waves are not in phase, the relationship between their phases must next be determined in order to extrapolate the positions of the atoms that gave rise to the diffraction pattern.

The traditional approach to solution of the “phase problem” employs **isomorphous displacement**. Prior to irradiation, an atom with a distinctive x-ray “signature” is introduced into a crystal at known positions in the primary structure of the protein. Heavy atom isomorphous displacement generally uses mercury or uranium, which bind to cysteine residues. An alternative approach uses the expression of plasmid-encoded recombinant proteins in which selenium replaces the sulfur of methionine. Expression uses a bacterial host auxotrophic for methionine biosynthesis and a defined medium in which selenomethionine replaces methionine. Alternatively, if the unknown structure is similar to one that has already been solved, **molecular replacement** on an existing model provides an attractive way to phase the data without the use of heavy atoms. Finally, the results from the phasing and Fourier summations provide an electron density profile or three-dimensional

map of how the atoms are connected or related to one another. The ability of some crystallized enzymes to act as catalysts suggests that their crystal structures faithfully reflect that of the enzyme in free solution.

Nuclear Magnetic Resonance Spectroscopy

Nuclear magnetic resonance (NMR) spectroscopy, a powerful complement to x-ray crystallography, measures the absorbance of radio frequency electromagnetic energy by certain atomic nuclei. “NMR-active” isotopes of biologically relevant elements include ^1H , ^{13}C , ^{15}N , and ^{31}P . The frequency, or chemical shift, at which a particular nucleus absorbs energy is a function of both the functional group within which it resides and the proximity of other NMR-active nuclei. Once limited to metabolites and relatively small macromolecules, ≤ 30 kDa, today proteins and protein complexes of >100 kDa can be analyzed by NMR. Two-dimensional NMR spectroscopy permits a three-dimensional representation of a protein to be constructed by determining the proximity of these nuclei to one another. NMR spectroscopy

analyzes proteins in aqueous solution. Not only does this obviate the need to form crystals (a particular advantage when dealing with difficult to crystallize membrane proteins), it renders possible real-time observation of the changes in conformation that accompany ligand binding or catalysis. It also offers the possibility of perhaps one day being able to observe the structure and dynamics of proteins (and metabolites) within living cells.

Cryo-Electron Microscopy

The development of the microscope in the 1600s by **van Leeuwenhoek** triggered a revolution in biology. For the first time, scientists were able to obtain two-dimensional images that revealed the cellular nature of living tissue and the existence of microbial organisms. However, the resolution of microscopic analyses was limited by the relatively long wavelength of the available sources of electromagnetic radiation, generally visible light ($4\text{--}7 \times 10^{-7}$ m). By coating materials spread in a monolayer with uranyl acetate or some other heavy metal-containing compound, **electron microscopy** [EM] can generate two-dimensional projection images at a resolution of a few Angstroms by using high energy electrons with wavelengths of $1\text{--}10 \times 10^{-12}$ m in place of visible light.

While the resolution of EM is sufficiently high to visualize viruses and large macromolecular complexes, exposure to streams of high energy electrons rapidly destroys organic materials such as proteins and polynucleotides. **Cryo-electron microscopy** (cryo-EM) extends the resolution of EM to biologic materials by employing cryogenic agents such as liquid nitrogen and liquid helium to protect organic matter from destruction. While not yet capable of attaining the atomic-level resolution of x-ray crystallography and NMR spectroscopy, the ability of cryo-EM to resolve and analyze individual macromolecules renders it well-suited for detecting conformational states and complexes. Moreover, its macromolecular resolution enables cryo-EM to be applied to the analysis of individual components within heterogeneous samples, whereas crystallography and NMR require large quantities of highly purified analytes.

Molecular Modeling

A valuable adjunct to the empirical determination of the three-dimensional structure of proteins is the use of computer technology for molecular modeling. When the three-dimensional structure is known, **molecular dynamics** programs can be used to simulate the conformational dynamics of a protein and the manner in which factors such as temperature, pH, ionic strength, or amino acid substitutions influence these motions. **Molecular docking** programs simulate the interactions that take place when a protein encounters a substrate, inhibitor, or other ligand. Virtual screening for molecules likely to interact with key sites on a protein of biomedical interest is extensively used to facilitate the discovery of new drugs.

Molecular modeling is also employed to infer the structure of proteins for which x-ray crystallographic or NMR structures

are not yet available. Secondary structure algorithms weigh the propensity of specific residues to become incorporated into α helices or β sheets in previously studied proteins to predict the secondary structure of other polypeptides. In **homology modeling**, the known three-dimensional structure of a protein is used as a template upon which to erect a model of the *probable* structure of a related protein. Scientists are working to devise computer programs that will reliably predict the three-dimensional conformation of a protein directly from its primary sequence, thereby permitting determination of the structures of the many unknown proteins for which templates currently are lacking.

PROTEIN FOLDING

Proteins are conformationally dynamic molecules that can fold into their functionally competent conformation in a time frame of milliseconds. Moreover, they often can refold if their conformation becomes disrupted, a process called renaturation. How are the remarkable speed and fidelity of protein folding attained? In nature, folding into the native state occurs too rapidly to be the product of a random, haphazard search of all possible structures. Denatured proteins are not just random coils. Native contacts are favored, and regions of the native structure persist even in the denatured state. Discussed below are factors that facilitate and are basic mechanistic features of protein folding-refolding.

Native Conformation of a Protein Is Thermodynamically Favored

The number of distinct combinations of phi and psi angles specifying potential conformations of even a relatively small—15 kDa—polypeptide is unbelievably vast. Proteins are guided through this vast labyrinth of possibilities by thermodynamics. Since the biologically relevant—or native—conformation of a protein generally is the one that is most energetically favored, knowledge of the native conformation is specified in the primary sequence. However, if one were to wait for a polypeptide to find its native conformation by random exploration of all possible conformations, the process would require billions of years to complete. Clearly, in nature, protein folding takes place in a more orderly and guided fashion.

Folding Is Modular

Protein folding generally occurs via a stepwise process. In the first stage, as the newly synthesized polypeptide emerges from the ribosome, short segments fold into secondary structural units that provide local regions of organized structure. Folding is now reduced to the selection of an appropriate arrangement of this relatively small number of secondary structural elements. In the second stage, the hydrophobic regions segregate into the interior of the protein away from solvent, forming a “molten globule,” a partially folded polypeptide in which the modules of the secondary structure rearrange until the mature

conformation of the protein is attained. This process is orderly, but not rigid. Considerable flexibility exists in the ways and in the order in which elements of secondary structure can be rearranged. In general, each element of the secondary or super-secondary structure facilitates proper folding by directing the folding process toward the native conformation and away from unproductive alternatives. For oligomeric proteins, individual protomers tend to fold before they associate with other subunits.

Auxiliary Proteins Assist Folding

Under appropriate laboratory conditions, many proteins will spontaneously refold after being **denatured** (ie, unfolded) by treatment with acid or base, chaotropic agents, or detergents. However, refolding under these conditions is slow—minutes to hours. Moreover, many proteins fail to spontaneously refold *in vitro*. Instead they form insoluble **aggregates**, disordered complexes of unfolded or partially folded polypeptides held together predominantly by hydrophobic interactions. Aggregates represent unproductive dead ends in the folding process. Cells employ auxiliary proteins to speed the process of folding and to guide it toward a productive conclusion.

Chaperones

Chaperone proteins participate in the folding of over half of all mammalian proteins. The hsp70 (70 kDa heat shock protein) family of chaperones binds short sequences of hydrophobic amino acids that emerge while a new polypeptide is being synthesized, shielding them from solvent. Chaperones prevent aggregation, thus providing an opportunity for the formation of appropriate secondary structural elements and their subsequent coalescence into a molten globule. The hsp60 family of chaperones, sometimes called **chaperonins**, differ in sequence and structure from hsp70 and its homologs. Hsp60 acts later in the folding process, often together with an hsp70 chaperone. The central cavity of the donut-shaped hsp60 chaperone provides a sheltered environment in which a polypeptide can fold until all hydrophobic regions are buried in its interior, thus preempting any tendency toward aggregation.

Protein Disulfide Isomerase

Disulfide bonds between and within polypeptides stabilize tertiary and quaternary structures. The process is initiated by the enzyme protein-sulfhydryl oxidase, which catalyzes the oxidation of cysteine residues to form disulfide bonds. However, disulfide bond formation is nonspecific—a given cysteine can form a disulfide bond with any accessible cysteinyl residue. By catalyzing disulfide exchange, the rupture of an S—S bond and its reformation with a different partner cysteine, protein disulfide isomerase facilitates the formation of disulfide bonds that stabilize a protein's native conformation. Since many eukaryotic sulfhydryl oxidases are flavin-dependent, dietary riboflavin deficiency often is accompanied by an increased incidence of improper folding of disulfide-containing proteins.

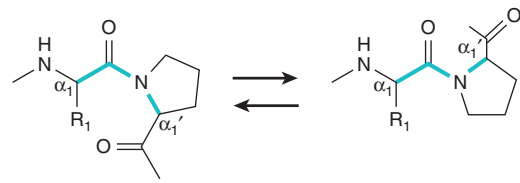

FIGURE 5-10 Isomerization of the *N*- α_1 prolyl peptide bond from a *cis* to a *trans* configuration relative to the backbone of the polypeptide.

Proline-*cis*, *trans*-Isomerization

All X-Pro peptide bonds—where X represents any residue—are synthesized in the *trans* configuration. However, of the X-Pro bonds of mature proteins, approximately 6% are *cis*. The *cis* configuration is particularly common in β turns. Isomerization from *trans* to *cis* is catalyzed by proline-*cis*, *trans*-isomerases, a family of enzymes also known as cyclophilins (**Figure 5-10**). In addition to promoting the maturation of native proteins, cyclophilins also participate in the folding of proteins expressed by viral invaders. Consequently, cyclophilins are being pursued as targets for the development of drugs such as cyclosporine and Alisporivir for the treatment of HIV, hepatitis C and other virally transmitted diseases.

Folding Is a Dynamic Process

Proteins are conformationally dynamic molecules that can fold and unfold hundreds or thousands of times in their lifetime. How do proteins, once unfolded, refold and restore their functional conformation? First, unfolding rarely leads to the complete randomization of the polypeptide chain inside the cell. Unfolded proteins generally retain a number of contacts and regions of the secondary structure that facilitate the refolding process. Second, chaperone proteins can “rescue” unfolded proteins that have become thermodynamically trapped in a misfolded dead end by unfolding hydrophobic regions and providing a second chance to fold productively. Glutathione can reduce inappropriate disulfide bonds that may be formed upon exposure to oxidizing agents such as O₂, hydrogen peroxide, or superoxide (see Chapter 54).

PERTURBATION OF PROTEIN CONFORMATION MAY HAVE PATHOLOGIC CONSEQUENCES

Prions

The transmissible spongiform encephalopathies, or **prion diseases**, are fatal neurodegenerative diseases characterized by spongiform changes, astrocytic gliomas, and neuronal loss resulting from the deposition of insoluble protein aggregates in neural cells. They include Creutzfeldt-Jakob disease in humans, scrapie in sheep, and bovine spongiform encephalopathy (mad cow disease) in cattle. A variant form of

Creutzfeldt-Jacob disease (vCJD) that afflicts younger patients is associated with early-onset psychiatric and behavioral disorders. Prion diseases may manifest themselves as infectious, genetic, or sporadic disorders. Because no viral or bacterial gene encoding the pathologic prion protein could be identified, the source and mechanism of transmission of prion disease long remained elusive.

Today it is recognized that **prion diseases are protein conformation diseases** transmitted by altering the conformation, and hence the physical properties, of proteins endogenous to the host. Human prion-related protein (PrP), a glycoprotein encoded on the short arm of chromosome 20, normally is monomeric and rich in α helix. Pathologic prion proteins serve as the templates for the conformational transformation of normal PrP, known as PrP^c, into PrP^{sc}. PrP^{sc} is rich in β sheet with many hydrophobic aminoacyl side chains exposed to solvent. As each new PrP^{sc} molecule is formed, it triggers the production of yet more pathologic variants in a conformational chain reaction. Because PrP^{sc} molecules associate strongly with one other through their exposed hydrophobic regions, the accumulating PrP^{sc} units coalesce to form insoluble protease-resistant aggregates. Since one pathologic prion or prion-related protein can serve as template for the conformational transformation of many times its number of PrP^c molecules, prion diseases can be transmitted by the protein alone without involvement of DNA or RNA.

Alzheimer's Disease

Refolding or misfolding of another protein endogenous to human brain tissue, β -amyloid, is a prominent feature of the Alzheimer's disease. While the main cause of the Alzheimer's disease remains elusive, the characteristic senile plaques and neurofibrillary bundles contain aggregates of the protein β -amyloid, a 4.3-kDa polypeptide produced by proteolytic cleavage of a larger protein known as amyloid precursor protein. In Alzheimer's disease patients, levels of β -amyloid become elevated, and this protein undergoes a conformational transformation from a soluble α helix-rich state to a state rich in β sheet and prone to self-aggregation. Apolipoprotein E has been implicated as a potential mediator of this conformational transformation.

Beta-Thalassemias

Thalassemias are caused by genetic defects that impair the synthesis of one of the polypeptide subunits of hemoglobin (see Chapter 6). During the burst of hemoglobin synthesis that occurs during erythrocyte development, a specific chaperone called α -hemoglobin-stabilizing protein (AHSP) binds to free hemoglobin α -subunits awaiting incorporation into the hemoglobin multimer. In the absence of this chaperone, free α -hemoglobin subunits aggregate, and the resulting precipitate has cytotoxic effects on the developing erythrocyte. Investigations using genetically modified mice suggest a role for AHSP in modulating the severity of β -thalassemia in human subjects.

COLLAGEN ILLUSTRATES THE ROLE OF POSTTRANSLATIONAL PROCESSING IN PROTEIN MATURATION

Protein Maturation Often Involves Making & Breaking of Covalent Bonds

The maturation of proteins into their final structural state often involves the cleavage or formation (or both) of covalent bonds, a process of **posttranslational modification**. Many polypeptides are initially synthesized as larger precursors called **proproteins**. The “extra” polypeptide segments in these proproteins often serve as leader sequences that target a polypeptide to a particular organelle or facilitate its passage through a membrane. Other segments ensure that the potentially harmful activity of a protein such as the proteases trypsin and chymotrypsin remains inhibited until these proteins reach their final destination. However, once these transient requirements are fulfilled, the now superfluous peptide regions are removed by selective proteolysis. Other covalent modifications may add new chemical functionalities to a protein. The maturation of collagen illustrates both of these processes.

Collagen Is a Fibrous Protein

Collagen is the most abundant of the fibrous proteins that constitute more than 25% of the protein mass in the human body. Other prominent fibrous proteins include keratin and myosin. These fibrous proteins represent a primary source of structural strength for cells (ie, the cytoskeleton) and tissues. Skin derives its strength and flexibility from an intertwined mesh of collagen and keratin fibers, while bones and teeth are buttressed by an underlying network of collagen fibers analogous to steel strands in reinforced concrete. Collagen also is present in connective tissues such as ligaments and tendons. The high degree of tensile strength required to fulfill these structural roles requires elongated proteins characterized by repetitive amino acid sequences and a regular secondary structure.

Collagen Forms a Unique Triple Helix

Tropocollagen, the repeating unit of a mature collagen fiber, consists of three collagen polypeptides, each containing about 1000 amino acids, bundled together in a unique conformation, the collagen triple helix (**Figure 5-11**). A mature collagen fiber

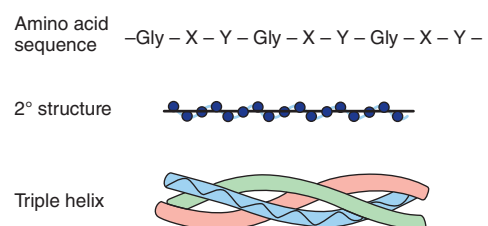

FIGURE 5-11 Primary, secondary, and tertiary structures of collagen.

forms an elongated rod with an axial ratio of about 200. Three intertwined polypeptide strands, which twist to the left, wrap around one another in a right-handed fashion to form the collagen triple helix. The opposing handedness of this superhelix and its component polypeptides makes the collagen triple helix highly resistant to unwinding—a principle also applied to the steel cables of suspension bridges. A collagen triple helix has 3.3 residues per turn and a rise per residue nearly twice that of an α helix. The R groups of each polypeptide strand of the triple helix pack so closely that, in order to fit, one of the three must be H. Thus, every third amino acid residue in collagen is a glycine residue. Staggering of the three strands provides appropriate positioning of the requisite glycines throughout the helix. Collagen is also rich in proline and hydroxyproline, yielding a repetitive Gly-X-Y pattern (Figure 5–11) in which Y generally is proline or hydroxyproline.

Collagen triple helices are stabilized by hydrogen bonds between residues in *different* polypeptide chains, a process helped by the hydroxyl groups of hydroxyprolyl residues. Additional stability is provided by covalent cross-links formed between modified lysyl residues both within and between polypeptide chains.

Collagen Is Synthesized as a Larger Precursor

Collagen is initially synthesized as a larger precursor polypeptide, procollagen. Numerous prolyl and lysyl residues of procollagen are hydroxylated by prolyl hydroxylase and lysyl hydroxylase, enzymes that require ascorbic acid (vitamin C; see Chapters 27 and 44). Hydroxyprolyl and hydroxylysyl residues provide additional hydrogen bonding capability that stabilizes the mature protein. In addition, glucosyl and galactosyl transferases attach glucosyl or galactosyl residues to the hydroxyl groups of specific hydroxylysyl residues.

The central portion of the precursor polypeptide then associates with other molecules to form the characteristic triple helix. This process is accompanied by the removal of the globular amino terminal and carboxyl terminal extensions of the precursor polypeptide by selective proteolysis. Certain lysyl residues are modified by lysyl oxidase, a copper-containing protein that converts ϵ -amino groups to aldehydes. The aldehydes can either undergo an aldol condensation to form a C=C double bond or to form a Schiff base (eneimine) with the ϵ -amino group of an unmodified lysyl residue, which is subsequently reduced to form a C—N single bond. These covalent bonds cross-link the individual polypeptides and imbue the fiber with exceptional strength and rigidity.

Nutritional & Genetic Disorders Can Impair Collagen Maturation

The complex series of events in collagen maturation provide a model that illustrates the biologic consequences of incomplete polypeptide maturation. The best-known defect in collagen biosynthesis is **scurvy**, a result of a dietary deficiency

of vitamin C required by prolyl and lysyl hydroxylases. The resulting deficit in the number of hydroxyproline and hydroxylysine residues undermines the conformational stability of collagen fibers, leading to bleeding gums, swelling joints, poor wound healing, and ultimately death. **Menkes syndrome**, characterized by kinky hair and growth retardation, reflects a dietary deficiency of the copper required by lysyl oxidase, which catalyzes a key step in the formation of the covalent cross-links that strengthen collagen fibers.

Genetic disorders of collagen biosynthesis include several forms of osteogenesis imperfecta, characterized by fragile bones. In the Ehlers-Danlos syndrome, a group of connective tissue disorders that involve impaired integrity of supporting structures, defects in the genes that encode α collagen-1, procollagen N-peptidase, or lysyl hydroxylase result in mobile joints and skin abnormalities (see Chapter 50).

SUMMARY

- Proteins may be classified based on their solubility, shape, or function or on the presence of a prosthetic group, such as heme.
- The gene-encoded primary structure of a polypeptide is the sequence of its amino acids. Its secondary structure results from folding of polypeptides into hydrogen-bonded motifs such as the α helix, the β pleated sheet, β bends, and loops. Combinations of these motifs can form supersecondary motifs.
- Tertiary structure concerns the relationships between secondary structural domains. Quaternary structure of proteins with two or more polypeptides (oligomeric proteins) concerns the spatial relationships between various types of polypeptides.
- Primary structures are stabilized by covalent peptide bonds. Higher orders of structure are stabilized by weak forces—multiple hydrogen bonds, salt (electrostatic) bonds, and association of hydrophobic R groups.
- The phi (Φ) angle of a polypeptide is the angle about the C _{α} —N bond; the psi (Ψ) angle is that about the C _{α} —C _{β} bond. Most combinations of phi-psi angles are disallowed due to steric hindrance. The phi-psi angles that form the α helix and the β sheet fall within the lower and upper left-hand quadrants of a Ramachandran plot, respectively.
- Protein folding is a poorly understood process. Broadly speaking, short segments of newly synthesized polypeptide fold into secondary structural units. Forces that bury hydrophobic regions from solvent then drive the partially folded polypeptide into a “molten globule” in which the modules of the secondary structure are rearranged to give the native conformation of the protein.
- Proteins that assist folding include protein disulfide isomerase, proline-*cis*, *trans*-isomerase, and the chaperones that participate in the folding of over half of mammalian proteins. Chaperones shield newly synthesized polypeptides from solvent and provide an environment for elements of secondary structure to emerge and coalesce into molten globules.
- Biomedical researchers are currently working to develop agents that interfere with the folding of viral proteins and prions as drugs for the treatment of hepatitis C and a range of neurodegenerative disorders.

- X-ray crystallography and NMR are key techniques used to study higher orders of protein structure.
- While lacking the atomic-level resolution of x-ray crystallography or NMR, cryo-EM has emerged as a powerful tool for analyzing the macromolecular dynamics of biological macromolecules in heterogeneous samples.
- Prions—protein particles that lack nucleic acid—cause fatal transmissible spongiform encephalopathies such as Creutzfeldt-Jakob disease, scrapie, and bovine spongiform encephalopathy. Prion diseases involve an altered secondary-tertiary structure of a naturally occurring protein, PrP^c. When PrP^c interacts with its pathologic isoform PrP^{Sc}, its conformation is transformed from a predominantly α -helical structure to the β -sheet structure characteristic of PrP^{Sc}.
- Collagen illustrates the close linkage between protein structure and biologic function. Diseases of collagen maturation include Ehlers-Danlos syndrome and the vitamin C deficiency disease scurvy.

REFERENCES

- Doyle SM, Genest O, Wickner S: Protein rescue from aggregates by powerful molecular chaperone machines. *Nat Rev Mol Cell Biol* 2013;10:617.
- Frausto SD, Lee E, Tang H: Cyclophilins as modulators of viral replication. *Viruses* 2013;5:1684.
- Hartl FU, Hayer-Hartl M: Converging concepts of protein folding in vitro and in vivo. *Nat Struct Biol* 2009;16:574.
- Ho BK, Thomas A, Brasseur R: Revisiting the Ramachandran plot: hard-sphere repulsion, electrostatics, and H-bonding in the α -helix. *Protein Sci* 2003;12:2508.
- Jorgensen WL: The many roles of computation in drug discovery. *Science* 2004;303:1813.
- Jucker M, Walker LC: Self-propagation of pathogenic protein aggregates in neurodegenerative diseases. *Nature* 2013;501:45.
- Kim YE, Hipp MS, Bracher A, et al: Molecular chaperone functions in protein folding and proteostasis. *Annu Rev Biochem* 2013;82:323.
- Kong Y, Zhou S, Kihm AJ, et al: Loss of alpha-hemoglobin-stabilizing protein impairs erythropoiesis and exacerbates beta-thalassemia. *J Clin Invest* 2004;114:1457.
- Kwan AH, Mobli M, Gooley PR, et al: Macromolecular NMR spectroscopy for the non-spectroscopist. *FEBS J* 2011; 278:687.
- Lee J, Kim SY, Hwang KJ, et al: Prion diseases as transmissible zoonotic diseases. *Osong Public Health Res Perspect* 2013;4:57.
- Milne JLS, Borgnia MJ, Bartesaghi A, et al: Cryo-electron microscopy: A primer for the non-microscopist. *FEBS J* 2013;280:28.
- Manthey KC, Chew YC, Zempleni J: Riboflavin deficiency impairs oxidative folding and secretion of apolipoprotein B-100 in HepG2 cells, triggering stress response systems. *J Nutr* 2005;135:978.
- Myllyharju J: Prolyl 4-hydroxylases, the key enzymes of collagen biosynthesis. *Matrix Biol* 2003;22:15.
- Narayan M: Disulfide bonds: Protein folding and subcellular protein trafficking. *FEBS J* 2013;279:2272.
- Rider MH, Bertrand L, Vertommen D, et al: 6-Phosphofructo-2-kinase/fructose-2,6-bisphosphatase: head-to-head with a bifunctional enzyme that controls glycolysis. *Biochem J* 2004;381:561.
- Shoulders MD, Raines RT: Collagen structure and stability. *Annu Rev Biochem* 2009;78:929.

Exam Questions

Section I – Proteins: Structure & Function

1. Explain how the Büchner's observation in the early part of the 20th century led to the discovery of the details of fermentation.
2. Name some of the earliest discoveries that followed the realization that a cell-free preparation of yeast cells could catalyze the process of fermentation.
3. Name some of the kinds of tissue preparations that early 20th century biochemists employed to study glycolysis and urea biosynthesis, and to discover the roles of vitamin derivatives.
4. Describe how the availability of radioactive isotopes facilitated the identification of metabolic intermediates.
5. Name several of the "inborn errors of metabolism" identified by the physician Archibald Garrod.
6. Cite an example in lipid metabolism for which the linking of biochemical and genetic approaches has contributed to the advance of medicine and biochemistry.
7. Name several of the intact "model" organisms whose genomes can be selectively altered to provide insight into biochemical processes.
8. Select the one of the following statements that is NOT CORRECT.
The propensity of water molecules to form hydrogen bonds with one another is the primary factor responsible for all of the following properties of water EXCEPT:
 - A. Its atypically high boiling point.
 - B. Its high heat of vaporization.
 - C. Its high surface tension.
 - D. Its ability to dissolve hydrocarbons.
 - E. Its expansion upon freezing.
9. Select the one of the following statements that is NOT CORRECT.
 - A. The side-chains of the amino acids cysteine and methionine absorb light at 280 nm.
 - B. Glycine is often present in regions where a polypeptide forms a sharp bend, reversing the direction of a polypeptide.
 - C. Polypeptides are named as derivatives of the C-terminal aminoacyl residue.
 - D. The C, N, O, and H atoms of a peptide bond are coplanar.
 - E. A linear pentapeptide contains four peptide bonds.
10. Select the one of the following statements that is NOT CORRECT.
 - A. Buffers of human tissue include bicarbonate, proteins, and orthophosphate.
 - B. A weak acid or a weak base exhibits its greatest buffering capacity when the pH is equal to its pK_a plus or minus one pH unit.
 - C. The isoelectric pH (pI) of lysine can be calculated using the formula $(pK_2 + pK_3)/2$.
 - D. The mobility of a monofunctional weak acid in a direct current electrical field reaches its maximum when the pH of its surrounding environment is equal to its pK_a .
 - E. For simplicity, the strengths of weak bases are generally expressed as the pK_a of their conjugate acids.
11. Select the one of the following statements that is NOT CORRECT.
 - A. If the pK_a of a weak acid is 4.0, 50% of the molecules will be in the dissociated state when the pH of the surrounding environment is 4.0.
 - B. A weak acid with a pK_a of 4.0 will be a more effective buffer at pH 3.8 than at pH 5.7.
 - C. At a pH equal to its pI a polypeptide carries no charged groups.
 - D. Strong acids and bases are so named because they undergo complete dissociation when dissolved in water.
 - E. The pK_a of an ionizable group can be influenced by the physical and chemical properties of its surrounding environment.
12. Select the one of the following statements that is NOT CORRECT.
 - A. A major objective of proteomics is to identify all of the proteins present in a cell under different conditions as well as their states of modification.
 - B. Mass spectrometry has largely replaced the Edman method for sequencing of peptides and proteins.
 - C. Sanger reagent was an improvement on Edman's because the former generates a new amino terminus, allowing several consecutive cycles of sequencing to take place.
 - D. Since mass is a universal property of all atoms and molecules, mass spectrometry is ideally suited to the detection of posttranslational modifications in proteins.
 - E. Time-of-flight mass spectrometers take advantage of the relationship $F = ma$.
13. Why does olive oil added to water tend to form large droplets?
14. What distinguishes a strong base from a weak base?
15. Select the one of the following statements that is NOT CORRECT.
 - A. Ion-exchange chromatography separates proteins based upon the sign and magnitude of their charge at a given pH.
 - B. Two-dimensional gel electrophoresis separates proteins first on the basis of their pI values and second on their charge-to-mass ratio using SDS-PAGE.
 - C. Affinity chromatography exploits the selectivity of protein-ligand interactions to isolate a specific protein from a complex mixture.
 - D. Many recombinant proteins are expressed with an additional domain fused to their N- or C-terminus. One common component of these fusion domains is a ligand-binding site designed expressly to facilitate purification by affinity chromatography.
 - E. Following purification by classical techniques, tandem mass spectrometry typically is used to analyze individual homogeneous peptides derived from a complex protein mixture.

16. Select the one of the following statements that is NOT CORRECT.
- Protein folding is assisted by intervention of specialized auxiliary proteins called chaperones.
 - Protein folding tends to be modular, with areas of local secondary structure forming first, then coalescing into a molten globule.
 - Protein folding is driven first and foremost by the thermodynamics of the water molecules surrounding the nascent polypeptide.
 - The formation of S-S bonds in a mature protein is facilitated by the enzyme protein disulfide isomerase.
 - Only a few unusual proteins, such as collagen, require posttranslational processing by partial proteolysis to attain their mature conformation.
17. Estimate pI for a polyelectrolyte that contains three carboxyl groups and three amino groups whose pK_a values are 4.0, 4.6, 6.3, 7.7, 8.9, and 10.2.
18. State one drawback of the categorization of the protein amino acids simply as “essential” or “nonessential”?
19. Select the one of the following statements that is NOT CORRECT.
- Posttranslational modifications of proteins can affect both their function and their metabolic fate.
 - The native conformational state generally is that which is thermodynamically favored.
 - The complex three-dimensional structures of most proteins are formed and stabilized by the cumulative effects of a large number of weak interactions.
 - Research scientists employ gene arrays for the high-throughput detection of the presence and expression level of proteins.
 - Examples of weak interactions that stabilize protein folding include hydrogen bonds, salt bridges, and van der Waals forces.
20. Select the one of the following statements that is NOT CORRECT.
- Changes in configuration involve the rupture of covalent bonds.
 - Changes in conformation involve the rotation of one or more single bonds.
 - The Ramachandran plot illustrates the degree to which steric hindrance limits the permissible angles of the single bonds in the backbone of a peptide or protein.
 - Formation of an α helix is stabilized by the hydrogen bonds between each peptide bond carboxyl oxygen and the N-H group of the next peptide bond.
 - In a β sheet the R groups of adjacent residues point in opposite directions relative to the plane of the sheet.
21. Select the one of the following statements that is NOT CORRECT.
- The descriptor $\alpha_2\beta_2\gamma_3$ denotes a protein with seven subunits of three different types.
 - Loops are extended regions that connect adjacent regions of secondary structure.
 - More than half of the residues in a typical protein reside in either α helices or β sheets.
 - Most β sheets have a right-handed twist.
 - Prions are viruses that cause protein-folding diseases that attack the brain.
22. What advantage does the acidic group of phosphoric acid that is associated with pK_2 offer for buffering in human tissues?
23. The dissociation constants for a previously uncharacterized racemic amino acid discovered in a meteor have been determined to be $pK_1 = 2.0$, $pK_2 = 3.5$, $pK_3 = 6.3$, $pK_4 = 8.0$, $pK_5 = 9.8$, and $pK_7 = 10.9$:
- What carboxyl or amino functional group would you expect to be associated with each dissociation?
 - What would be the approximate net charge on this amino acid at pH 2?
 - What would be its approximate net charge at pH 6.3?
 - During direct current electrophoresis at pH 8.5, toward which electrode would this amino acid be likely to move?
24. A biochemical buffer is a compound which tends to resist changes in pH even when acids or bases are added. What two properties are required of an effective physiologic buffer? In addition to phosphate, what other physiologic compounds meet these criteria?
25. Name two amino acids whose posttranslational modification confers significant new properties to a protein.
26. Explain why diets deficient in (a) copper (Cu) or (b) ascorbic acid lead to incomplete posttranslational processing of collagen.
27. Describe the role of N-terminal signal sequences in the biosynthesis of certain proteins.



Enzymes: Kinetics, Mechanism, Regulation, & Bioinformatics

6

Proteins: Myoglobin & Hemoglobin

Peter J. Kennelly, PhD & Victor W. Rodwell, PhD

OBJECTIVES

*After studying this chapter,
you should be able to:*

- Describe the most important structural similarities and differences between myoglobin and hemoglobin.
- Sketch binding curves for the oxygenation of myoglobin and hemoglobin.
- Identify the covalent linkages and other close associations between heme and globin in oxymyoglobin and oxyhemoglobin.
- Explain why the physiologic function of hemoglobin requires that its O₂-binding curve be sigmoidal rather than hyperbolic.
- Explain the role of a hindered environment on the ability of hemoglobin to bind carbon monoxide.
- Define P₅₀ and indicate its significance in oxygen transport and delivery.
- Describe the structural and conformational changes in hemoglobin that accompany its oxygenation and subsequent deoxygenation.
- Explain the role of 2,3-bisphosphoglycerate (BPG) in oxygen binding and delivery.
- Outline the role of hemoglobin in CO₂ and proton transport, and describe accompanying changes in the pK_a of the relevant imidazolium group.
- Describe the structural consequences to HbS of lowering pO₂.
- Identify the metabolic defect that occurs as a consequence of α- and β-thalassemias.

BIOMEDICAL IMPORTANCE

The efficient delivery of oxygen from the lungs to the peripheral tissues and the maintenance of tissue reserves to protect against anoxic episodes are essential to health. In mammals, these functions are performed by the homologous heme proteins hemoglobin and myoglobin, respectively. Myoglobin, a monomeric protein of red muscle, binds oxygen tightly as a

reserve against oxygen deprivation. The multiple subunits of hemoglobin, a tetrameric protein of erythrocytes, interact in a cooperative fashion that enables this transporter to offload a high proportion of bound O₂ in peripheral tissues while simultaneously retaining the capacity to bind it efficiently in the lungs. In addition to delivering O₂, hemoglobin scavenges the waste products of respiration, CO₂ and protons, for transport to and ultimate disposal in the lungs. Oxygen delivery is

enhanced by the binding of 2,3-bisphosphoglycerate (BPG), which stabilizes the quaternary structure of deoxyhemoglobin. Hemoglobin and myoglobin illustrate both protein structure–function relationships and the molecular basis of genetic disorders such as sickle cell disease and the thalassemias. Cyanide and carbon monoxide kill because they disrupt the physiologic function of the heme proteins cytochrome oxidase and hemoglobin, respectively.

HEME & FERROUS IRON CONFER THE ABILITY TO STORE & TO TRANSPORT OXYGEN

Myoglobin and hemoglobin contain **heme**, a cyclic tetrapyrrole consisting of four molecules of pyrrole linked by methyne bridges. This planar network of conjugated double bonds absorbs visible light and colors heme deep red. The substituents at the β -positions of heme are methyl (M), vinyl (V), and propionate (Pr) groups arranged in the order M, V, M, V, M, Pr, Pr, M (**Figure 6–1**). The atom of ferrous iron (Fe^{2+}) resides at the center of the planar tetrapyrrole. Other proteins with metal-containing tetrapyrrole prosthetic groups include the cytochromes (Fe and Cu) and chlorophyll (Mg) (see Chapter 31). Oxidation and reduction of the Fe and Cu atoms of cytochromes are essential to their biologic function as carriers of electrons. By contrast, oxidation of the Fe^{2+} of myoglobin or hemoglobin to Fe^{3+} destroys their biologic activity.

Myoglobin Is Rich in α Helix

Oxygen stored in red muscle myoglobin is released during O_2 deprivation (eg, severe exercise) for use in muscle mitochondria for aerobic synthesis of ATP (see Chapter 13). A 153-aminoacyl

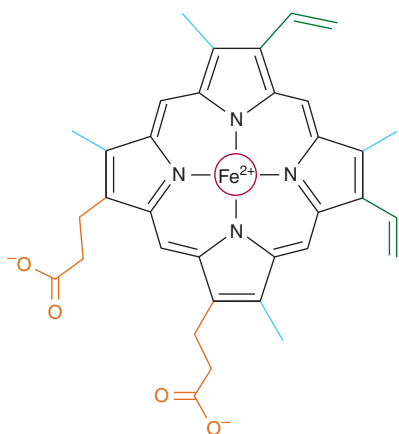

FIGURE 6–1 Heme. The pyrrole rings and methyne bridge carbons are coplanar, and the iron atom (Fe^{2+}) resides in almost the same plane. The fifth and sixth coordination positions of Fe^{2+} are directly perpendicular to—and directly above and below—the plane of the heme ring. Observe the nature of the methyl (blue), vinyl (green), and propionate (orange) substituent groups on the β carbons of the pyrrole rings, the central iron atom (red), and the location of the polar side of the heme ring (at about 7 o'clock) that faces the surface of the myoglobin molecule.

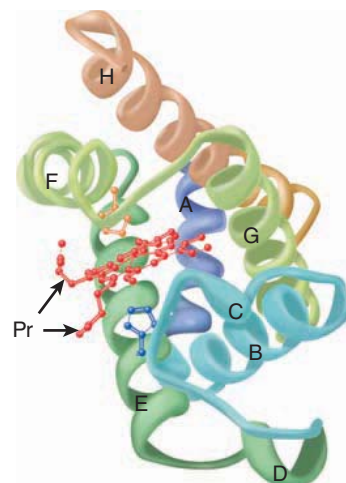

FIGURE 6–2 Three-dimensional structure of myoglobin.

Shown is a ribbon diagram tracing the polypeptide backbone of myoglobin. The color of the polypeptide chain is graded along the visible spectrum from blue (N-terminal) to tan (C-terminal). The heme prosthetic group is red. The α -helical regions are designated A through H. The distal (E7) and proximal (F8) histidine residues are highlighted in blue and orange, respectively. Note how the polar propionate substituents (Pr) project out of the heme toward solvent. (Adapted from Protein Data Bank ID no. 1a6n.)

residue polypeptide (MW 17,000), the compactly folded myoglobin molecule measures $4.5 \times 3.5 \times 2.5$ nm (**Figure 6–2**). An unusually high proportion, about 75%, of the residues are present in eight right-handed 7–20 residue α helices. Starting at the amino terminal, these are termed helices A–H. Typical of globular proteins, the surface of myoglobin is rich in amino acids bearing polar and potentially charged side chains, while—with two exceptions—the interior contains residues that possess nonpolar R groups (eg, Leu, Val, Phe, and Met). The exceptions are the seventh and eighth residues in helices E and F, His E7 and His F8, which lie close to the heme iron, where they function in O_2 binding.

Histidines F8 & E7 Perform Unique Roles in Oxygen Binding

The heme of myoglobin lies in a crevice between helices E and F oriented with its polar propionate groups facing the surface of the globin (**Figure 6–2**). The remainder resides in the nonpolar interior. The fifth coordination position of the iron is occupied by a nitrogen from the imidazole ring of the **proximal histidine**, His F8. The **distal histidine**, His E7, lies on the side of the heme ring opposite to His F8.

The Iron Moves Toward the Plane of the Heme When Oxygen Is Bound

The iron of unoxygenated myoglobin lies 0.03 nm (0.3 Å) outside the plane of the heme ring, toward His F8. Consequently, the heme “puckers” slightly. When O_2 occupies the sixth coordination position, the iron moves to within 0.01 nm (0.1 Å) of the plane of the heme ring. Oxygenation of myoglobin thus is

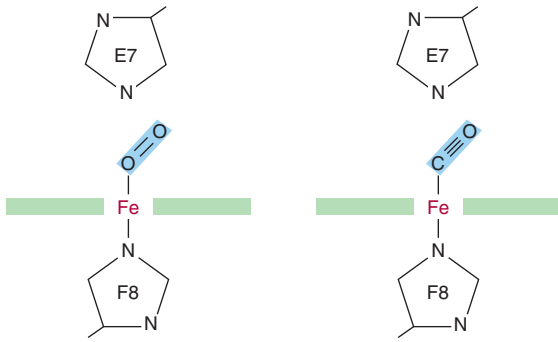

FIGURE 6-3 Angles for bonding of oxygen and carbon monoxide (CO) to the heme iron of myoglobin. The distal E7 histidine hinders bonding of CO at the preferred (90°) angle to the plane of the heme ring.

accompanied by motion of the iron, of His F8, and of residues linked to His F8.

Apomyoglobin Provides a Hindered Environment for the Heme Iron

When O_2 binds to myoglobin, the bond that links the first and second oxygen atoms lies at an angle of 121° to the plane of the heme, orienting the second oxygen away from the distal histidine (Figure 6-3, left). This permits maximum overlap between the iron and one of the lone pairs of electrons on the sp^2 hybridized oxygen atoms, which lie at an angle of roughly 120° to the axis of the $O=O$ double bond (Figure 6-4, left). Isolated heme binds carbon monoxide (CO) 25,000 times more strongly than oxygen. So why is it that CO does not completely displace O_2 from heme iron? CO is present in minute, but still finite, quantities in the atmosphere and arises in cells from the catabolism of heme. The accepted explanation is that the apoproteins of myoglobin and hemoglobin create a **hindered environment** for their gaseous ligands. When CO binds to isolated heme, all three atoms (Fe, C, and O) lie perpendicular to the plane of the heme. This geometry maximizes the overlap between the lone pair of electrons on the

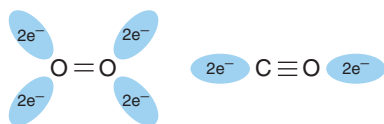

FIGURE 6-4 Orientation of the lone pairs of electrons relative to the $O=O$ and $C\equiv O$ bonds of oxygen and carbon monoxide. In molecular oxygen, formation of the double bond between the two oxygen atoms is facilitated by the adoption of an sp^2 hybridization state by the valence electron of each oxygen atom. As a consequence, the two atoms of the oxygen molecule and each lone pair of electrons are coplanar and separated by an angle of roughly 120° (left). By contrast, the two atoms of carbon monoxide are joined by a triple bond, which requires that the carbon and oxygen atoms adopt an sp hybridization state. In this state the lone pairs of electrons and triple bonds are arranged in a linear fashion, where they are separated by an angle of 180° (right).

sp hybridized oxygen of the CO molecule and the Fe^{2+} iron (Figure 6-4, right). However, in myoglobin and hemoglobin the distal histidine sterically precludes this preferred, high-affinity orientation of CO while still permitting O_2 to attain its most favorable orientation. Binding at a less favored angle reduces the strength of the heme-CO bond to about 200 times that of the heme- O_2 bond (Figure 6-3, right). Therefore O_2 , which is present in great excess over CO, normally dominates. Nevertheless, about 1% of myoglobin typically is present combined with CO.

THE OXYGEN DISSOCIATION CURVES FOR MYOGLOBIN & HEMOGLOBIN SUIT THEIR PHYSIOLOGIC ROLES

Why is myoglobin unsuitable as an O_2 transport protein but well suited for O_2 storage? The relationship between the concentration, or partial pressure, of O_2 (P_{O_2}) and the quantity of O_2 bound is expressed as an O_2 saturation isotherm (Figure 6-5). The oxygen-binding curve for myoglobin is hyperbolic. Myoglobin therefore loads O_2 readily at the P_{O_2} of the lung capillary bed (100 mm Hg). However, since myoglobin releases only a small fraction of its bound O_2 at the P_{O_2} values typically encountered in active muscle (20 mm Hg) or other tissues (40 mm Hg), it represents an ineffective vehicle for delivery of O_2 . When strenuous exercise lowers the P_{O_2} of muscle tissue to about 5 mm of Hg, the dissociation of O_2 from myoglobin permits mitochondrial synthesis of ATP, and hence muscular activity, to continue.

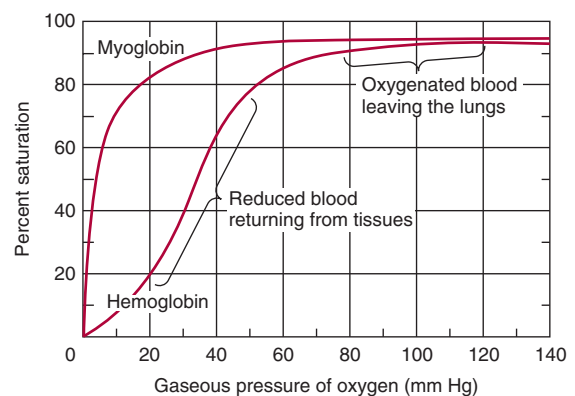

FIGURE 6-5 Oxygen-binding curves of both hemoglobin and myoglobin. Arterial oxygen tension is about 100 mm Hg; mixed venous oxygen tension is about 40 mm Hg; capillary (active muscle) oxygen tension is about 20 mm Hg; and the minimum oxygen tension required for cytochrome oxidase is about 5 mm Hg. Association of chains into a tetrameric structure (hemoglobin) results in much greater oxygen delivery than would be possible with single chains. (Modified, with permission, from Scriver CR, et al (editors): *The Molecular and Metabolic Bases of Inherited Disease*, 7th ed. McGraw-Hill, 1995.)

THE ALLOSTERIC PROPERTIES OF HEMOGLOBINS RESULT FROM THEIR QUATERNARY STRUCTURES

The properties of individual hemoglobins are consequences of their quaternary as well as of their secondary and tertiary structures. The quaternary structure of hemoglobin confers striking additional properties, absent from monomeric myoglobin, which adapts it to its unique biologic roles. The **allosteric** (Gk *allos* “other,” *steros* “space”) properties of hemoglobin provide, in addition, a model for understanding other allosteric proteins (see Chapter 17).

Hemoglobin Is Tetrameric

Hemoglobins are tetramers composed of pairs of two different polypeptide subunits (**Figure 6–6**). Greek letters are used to

designate each subunit type. The subunit composition of the principal hemoglobins are $\alpha_2\beta_2$ (HbA; normal adult hemoglobin), $\alpha_2\gamma_2$ (HbF; fetal hemoglobin), $\alpha_2\beta^s_2$ (HbS; sickle cell hemoglobin), and $\alpha_2\delta_2$ (HbA₂; a minor adult hemoglobin). The primary structures of the β , γ , and δ chains of human hemoglobin are highly conserved.

Myoglobin & the β Subunits of Hemoglobin Share Almost Identical Secondary and Tertiary Structures

Despite differences in the kind and number of amino acids present, myoglobin and the β polypeptide of hemoglobin A share almost identical secondary and tertiary structures. Similarities include the location of the heme and the helical regions, and the presence of amino acids with similar properties at comparable locations. Although it possesses seven rather than eight helical regions, the α polypeptide of hemoglobin also closely resembles myoglobin.

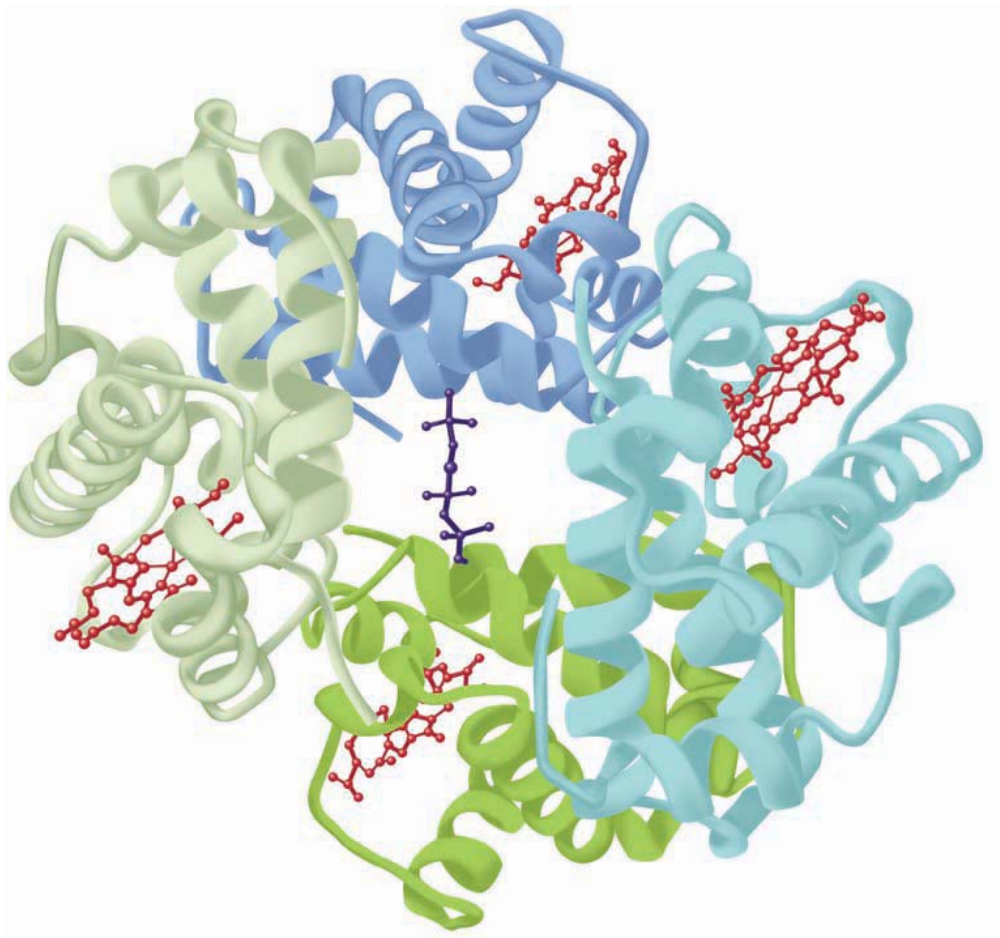

FIGURE 6–6 Hemoglobin. Shown is the three-dimensional structure of deoxyhemoglobin with a molecule of 2,3-bisphosphoglycerate (dark blue) bound. The two α subunits are colored in the darker shades of green and blue, the two β subunits in the lighter shades of green and blue, and the heme prosthetic groups in red. (Adapted from Protein Data Bank ID no. 1b86.)

Oxygenation of Hemoglobin Triggers Conformational Changes in the Apoprotein

Hemoglobins bind four molecules of O_2 per tetramer, one per heme. A molecule of O_2 binds to a hemoglobin tetramer more readily if other O_2 molecules are already bound (Figure 6–5). Termed **cooperative binding**, this phenomenon permits hemoglobin to maximize both the quantity of O_2 loaded at the P_{O_2} of the lungs and the quantity of O_2 released at the P_{O_2} of the peripheral tissues. Cooperative interactions, an exclusive property of *multimeric* proteins, are critically important to aerobic life.

P_{50} Expresses the Relative Affinities of Different Hemoglobins for Oxygen

The quantity P_{50} , a measure of O_2 concentration, is the partial pressure of O_2 at which a given hemoglobin reaches half-saturation. Depending on the organism, P_{50} can vary widely, but in all instances it will exceed the P_{O_2} of the peripheral tissues. For example, the values of P_{50} for HbA and HbF are 26 and 20 mm Hg, respectively. In the placenta, this difference enables HbF to extract oxygen from the HbA in the mother's blood. However, HbF is suboptimal postpartum since its higher affinity for O_2 limits the quantity of O_2 delivered to the tissues.

The subunit composition of hemoglobin tetramers undergoes complex changes during development. The human fetus initially synthesizes a $\xi_2\varepsilon_2$ tetramer. By the end of the first trimester, ξ and ε subunits have been replaced by α and γ subunits, forming HbF ($\alpha_2\gamma_2$), the hemoglobin of late fetal life. While synthesis of β subunits begins in the third trimester, the replacement of γ subunits by β subunits to yield adult HbA ($\alpha_2\beta_2$) does not reach completion until some weeks postpartum (Figure 6–7).

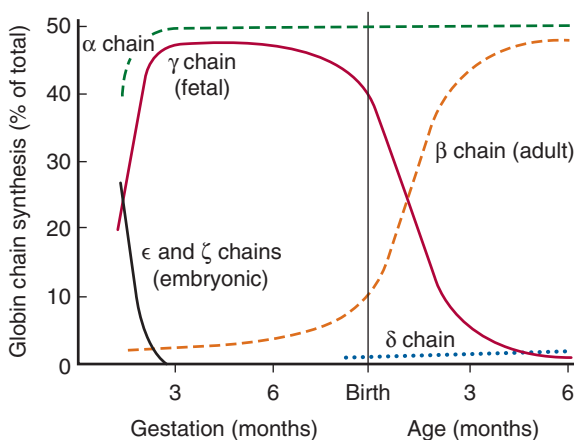

FIGURE 6–7 Developmental pattern of the quaternary structure of fetal and newborn hemoglobins. (Reproduced, with permission, from Ganong WF: *Review of Medical Physiology*, 20th ed. McGraw-Hill, 2001.)

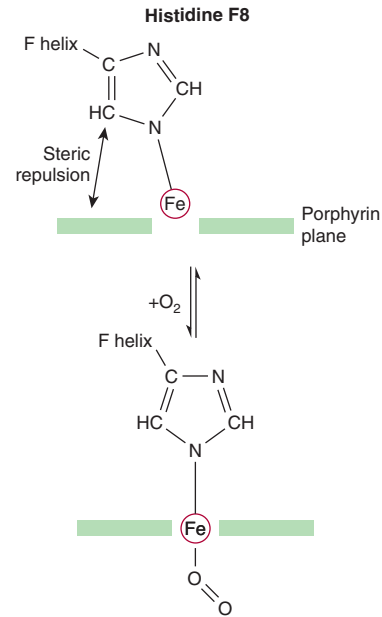

FIGURE 6–8 On oxygenation of hemoglobin the iron atom moves into the plane of the heme. Histidine F8 and its associated aminoacyl residues are pulled along with the iron atom. For a representation of this motion, see <http://www.rcsb.org/pdb/101/motm.do?momID=41>. (Slightly modified and reproduced, with permission, from Stryer L: *Biochemistry*, 4th ed. Freeman, 1995. Copyright © 1995 W. H. Freeman and Company.)

Oxygenation of Hemoglobin Is Accompanied by Large Conformational Changes

The binding of the first O_2 molecule to deoxyHb shifts the heme iron toward the plane of the heme ring from a position about 0.04 nm beyond it (Figure 6–8). This motion is transmitted to the proximal (F8) histidine and to the residues attached thereto, which in turn causes the rupture of salt bridges between the carboxyl terminal residues of all four subunits. As a result, one pair of α/β subunits rotates 15° with respect to the other, compacting the tetramer (Figure 6–9). Profound changes in secondary, tertiary, and quaternary structures accompany the O_2 -induced transition of hemoglobin from the low-affinity **T (taut) state** to

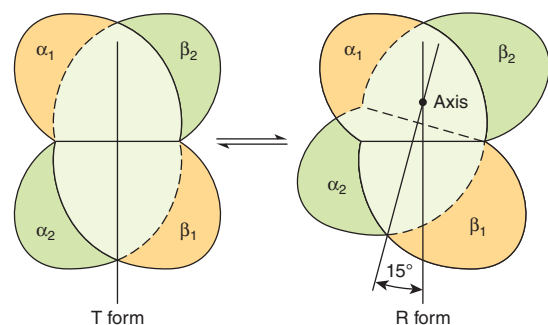

FIGURE 6–9 During transition of the T form to the R form of hemoglobin, the $\alpha_2\beta_2$ pair of subunits (green) rotates through 15° relative to the pair of $\alpha_1\beta_1$ subunits (yellow). The axis of rotation is eccentric, and the $\alpha_2\beta_2$ pair also shifts toward the axis somewhat. In the representation, the tan $\alpha_1\beta_1$ pair is shown fixed while the green $\alpha_2\beta_2$ pair of subunits both shifts and rotates.

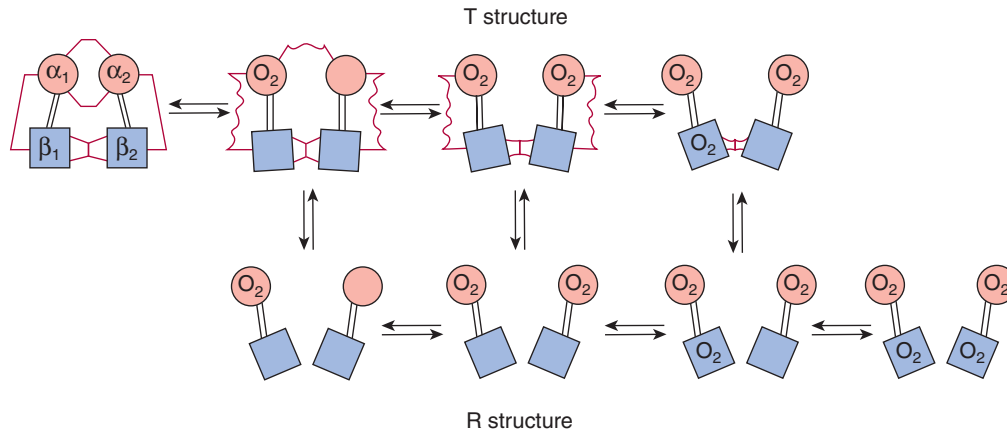
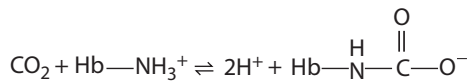

FIGURE 6-10 Transition from the T structure to the R structure. In this model, salt bridges (red lines) linking the subunits in the T structure break progressively as oxygen is added, and even those salt bridges that have not yet ruptured are progressively weakened (wavy red lines). The transition from T to R does not take place after a fixed number of oxygen molecules have been bound but becomes more probable as each successive oxygen binds. The transition between the two structures is influenced by protons, carbon dioxide, chloride, and BPG; the higher their concentration, the more oxygen must be bound to trigger the transition. Fully oxygenated molecules in the T structure and fully deoxygenated molecules in the R structure are not shown because they are unstable. (Modified and redrawn, with permission, from Perutz MF: Hemoglobin structure and respiratory transport. *Sci Am* [Dec] 1978;239:92.)

the high-affinity **R (relaxed) state**. These changes significantly increase the affinity of the remaining unoxygenated hemes for O_2 , as subsequent binding events require the rupture of fewer salt bridges (Figure 6-10). The terms T and R also are used to refer to the low-affinity and high-affinity conformations of allosteric enzymes, respectively.

After Releasing O_2 at the Tissues, Hemoglobin Transports CO_2 & Protons to the Lungs

In addition to transporting O_2 from the lungs to peripheral tissues, hemoglobin transports CO_2 , the byproduct of respiration, and protons from peripheral tissues to the lungs. Hemoglobin carries CO_2 as carbamates formed with the amino terminal nitrogens of the polypeptide chains:



Carbamate formation changes the charge on amino terminals from positive to negative, favoring salt bridge formation between α and β chains.

Hemoglobin carbamates account for about 15% of the CO_2 in venous blood. Much of the remaining CO_2 is carried as bicarbonate, which is formed in erythrocytes by the hydration of CO_2 to carbonic acid (H_2CO_3), a process catalyzed by carbonic anhydrase. At the pH of venous blood, H_2CO_3 dissociates into bicarbonate and a proton.

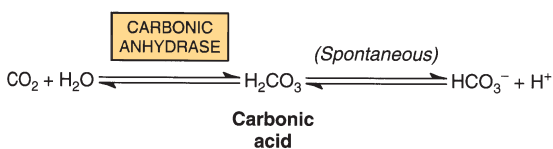

Deoxyhemoglobin binds one proton for every two O_2 molecules released, contributing significantly to the buffering capacity of blood. The somewhat lower pH of peripheral tissues, aided by carbamation, stabilizes the T state and thus enhances the delivery of O_2 . In lungs, the process reverses. As O_2 binds to deoxyhemoglobin, protons are released and combine with bicarbonate to form carbonic acid. Dehydration of H_2CO_3 , catalyzed by carbonic anhydrase, forms CO_2 , which is exhaled. Binding of oxygen thus drives the exhalation of CO_2 (Figure 6-11). This reciprocal coupling of proton and O_2 binding is termed the **Bohr effect**. The Bohr effect is dependent upon **cooperative interactions between the hemes of the hemoglobin tetramer**. By contrast, the monomeric structure of myoglobin precludes it from exhibiting the Bohr effect.

Protons Arise From Rupture of Salt Bridges When O_2 Binds

Protons responsible for the Bohr effect arise from rupture of salt bridges during the binding of O_2 to T-state hemoglobin. In the lungs, conversion to the oxygenated R state breaks salt bridges involving β chain residue His 146. The subsequent dissociation of protons from His 146 drives the conversion of bicarbonate to carbonic acid (Figure 6-11). Upon the release of O_2 , the T structure and its salt bridges re-form. This conformational change increases the pK_a of the β chain His 146 residues, which bind protons. By facilitating the re-formation of salt bridges, an increase in proton concentration enhances the release of O_2 from oxygenated (R-state) hemoglobin. Conversely, an increase in P_{O_2} promotes proton release.

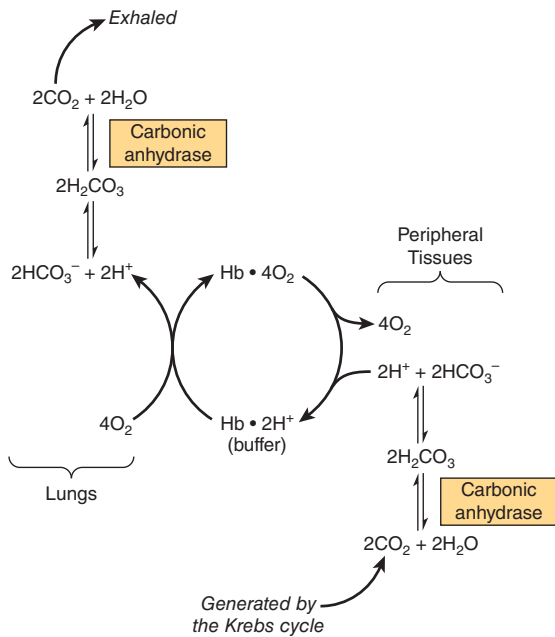

FIGURE 6-11 The Bohr effect. Carbon dioxide generated in peripheral tissues combines with water to form carbonic acid, which dissociates into protons and bicarbonate ions. Deoxyhemoglobin acts as a buffer by binding protons and delivering them to the lungs. In the lungs, the uptake of oxygen by hemoglobin releases protons that combine with bicarbonate ion, forming carbonic acid, which when dehydrated by carbonic anhydrase becomes carbon dioxide, which then is exhaled.

2,3-BPG Stabilizes the T Structure of Hemoglobin

A low P_{O_2} in peripheral tissues promotes the synthesis of 2,3-bisphosphoglycerate (BPG) in erythrocytes. The hemoglobin tetramer binds one molecule of BPG in the central cavity formed by its four subunits (Figure 6-6). However, the space between the H helices of the β chains lining the cavity is sufficiently wide to accommodate BPG only when hemoglobin is in the T state. BPG forms salt bridges with the terminal amino groups of both β chains via Val NA1 and with Lys EF6 and His H21 (Figure 6-12). BPG therefore stabilizes deoxygenated (T-state) hemoglobin by forming additional salt bridges that must be broken prior to conversion to the R state.

Synthesis of BPG from the glycolytic intermediate 1,3-bisphosphoglycerate is catalyzed by the bifunctional enzyme **2,3-bisphosphoglycerate synthase/2-phosphatase (BPGM)**. BPG is hydrolyzed to 3-phosphoglycerate by the 2-phosphatase activity of BPGM and to 2-phosphoglycerate by a second enzyme, multiple inositol polyphosphate phosphatase (MIPP). The activities of these enzymes, and hence the level of BPG in erythrocytes, are sensitive to pH. As a consequence, BPG concentration and binding are influenced by and, reinforce the impact of, the Bohr effect on O_2 binding and delivery by hemoglobin.

Residue H21 of the γ subunit of HbF is Ser rather than His. Since Ser cannot form a salt bridge, BPG binds more weakly to HbF than to HbA. The lower stabilization afforded

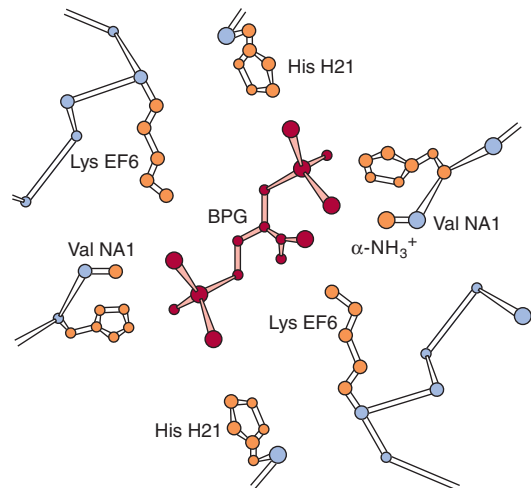

FIGURE 6-12 Mode of binding of 2,3-bisphosphoglycerate (BPG) to human deoxyhemoglobin. BPG interacts with three positively charged groups on each β chain. (Based on Arnone A: X-ray diffraction study of binding of 2,3-diphosphoglycerate to human deoxyhemoglobin. *Nature* 1972;237:146. Copyright © 1972. Adapted by permission from Macmillan Publishers Ltd.)

to the T state by BPG accounts for HbF having a higher affinity for O_2 than HbA.

Adaptation to High Altitude

Physiologic changes that accompany prolonged exposure to high altitude include increases in the number of erythrocytes, the concentration of hemoglobin within them, and the synthesis of BPG. Elevated BPG lowers the affinity of HbA for O_2 (increases P_{50}), which enhances the release of O_2 at peripheral tissues.

NUMEROUS MUTATIONS AFFECTING HUMAN HEMOGLOBINS HAVE BEEN IDENTIFIED

Mutations in the genes that encode the α or β subunits of hemoglobin potentially can affect its biologic function. However, almost all of the over 1100 known genetic mutations affecting human hemoglobins are both extremely rare and benign, presenting no clinical abnormalities. When a mutation does compromise biologic function, the condition is termed a **hemoglobinopathy**. It is estimated that more than 7% of the globe's population are carriers for hemoglobin disorders. The URL <http://globin.cse.psu.edu/> (Globin Gene Server) provides information about—and links for—normal and mutant hemoglobins. Selected examples are described below.

Methemoglobin & Hemoglobin M

In methemoglobinemia, the heme iron is ferric rather than ferrous. Methemoglobin thus can neither bind nor transport O_2 . Normally, the enzyme methemoglobin reductase

reduces the Fe^{3+} of methemoglobin to Fe^{2+} . Methemoglobin can arise by oxidation of Fe^{2+} to Fe^{3+} as a side effect of agents such as sulfonamides, from hereditary hemoglobin M, or consequent to reduced activity of the enzyme methemoglobin reductase.

In hemoglobin M, histidine F8 (His F8) has been replaced by tyrosine. The iron of HbM forms a tight ionic complex with the phenolate anion of tyrosine that stabilizes the Fe^{3+} form. In α -chain hemoglobin M variants, the R-T equilibrium favors the T state. Oxygen affinity is reduced, and the Bohr effect is absent. β -Chain hemoglobin M variants exhibit R-T switching, and the Bohr effect is therefore present.

Mutations that favor the R state (eg, hemoglobin Chesapeake) increase O_2 affinity. These hemoglobins therefore fail to deliver adequate O_2 to peripheral tissues. The resulting tissue hypoxia leads to **polycythemia**, an increased concentration of erythrocytes.

Hemoglobin S

In HbS, the nonpolar amino acid valine has replaced the polar surface residue Glu6 of the β subunit, generating a hydrophobic “**sticky patch**” on the surface of the β subunit of both oxyHbS and deoxyHbS. Both HbA and HbS contain a complementary sticky patch on their surfaces that is exposed only in the deoxygenated T state. Thus, at low PO_2 , deoxy-HbS can polymerize to form long, insoluble fibers. Binding of deoxyHbA terminates fiber polymerization, since HbA lacks the second sticky patch necessary to bind another Hb molecule (**Figure 6–13**). These twisted helical fibers distort the erythrocyte into a characteristic sickle shape, rendering it vulnerable to lysis in the interstices of the splenic sinusoids. They also cause multiple secondary clinical effects. A low PO_2 , such as that at high altitudes, exacerbates the tendency to polymerize. Emerging treatments for sickle cell disease include inducing HbF expression to inhibit the polymerization of HbS, stem cell transplantation, and, in the future, gene therapy.

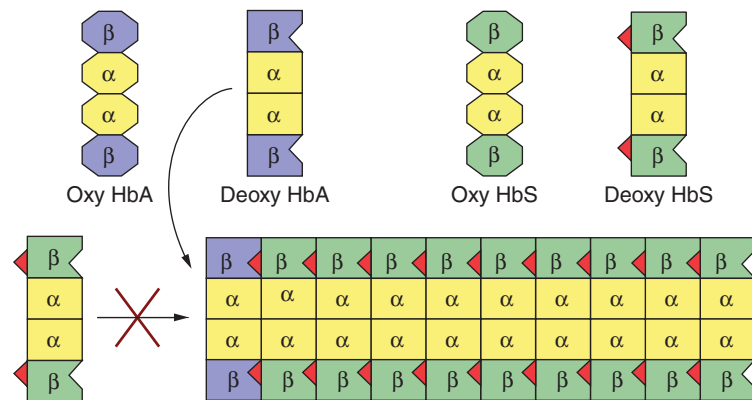

FIGURE 6–13 Polymerization of deoxyhemoglobin S. The dissociation of oxygen from hemoglobin S (HbS) unmasks a sticky patch (red triangle) on the surface of its β -subunits (green) that can adhere to a complementary site on the β -subunits of other molecules of deoxyHbS. Polymerization to a fibrous polymer is interrupted by deoxyHbA, whose β -subunits (lavender) lack the sticky patch required for binding additional HbS subunits. (Modified and reproduced, with permission, from Stryer L: *Biochemistry*, 4th ed. Freeman, 1995. Copyright © 1995 W. H. Freeman and Company.)

BIOMEDICAL IMPLICATIONS

Myoglobinuria

Following massive crush injury to skeletal muscle followed by renal damage, released myoglobin may appear in the urine. Myoglobin can be detected in plasma following a myocardial infarction, but assay of serum enzymes (see Chapter 7) provides a more sensitive index of myocardial injury.

Anemias

Anemias, reductions in the number of red blood cells or of hemoglobin in the blood, can reflect impaired synthesis of hemoglobin (eg, in iron deficiency; see Chapter 53) or impaired production of erythrocytes (eg, in folic acid or vitamin B_{12} deficiency; see Chapter 44). Diagnosis of anemias begins with spectroscopic measurement of blood hemoglobin levels.

Thalassemias

The genetic defects known as thalassemias result from the partial or total absence of one or more α or β chains of hemoglobin. Over 750 different mutations have been identified, but only three are common. Either the α chain (alpha thalassemias) or β chain (beta thalassemias) can be affected. A superscript indicates whether a subunit is completely absent (α^0 or β^0) or whether its synthesis is reduced (α^- or β^-). Apart from marrow transplantation, treatment is symptomatic.

Certain mutant hemoglobins are common in many populations, and a patient may inherit more than one type. Hemoglobin disorders thus present a complex pattern of clinical phenotypes. The use of DNA probes for their diagnosis is considered in Chapter 39.

Glycated Hemoglobin (HbA_{1c})

When blood glucose enters the erythrocytes, it glycosylates the ϵ -amino group of lysyl residues and the amino terminals of hemoglobin. The fraction of hemoglobin glycosylated, normally

about 5%, is proportionate to blood glucose concentration. Since the half-life of an erythrocyte is typically 60 days, the level of glycated hemoglobin (HbA_{1c}) reflects the mean blood glucose concentration over the preceding 6 to 8 weeks. Measurement of HbA_{1c} therefore provides valuable information for management of diabetes mellitus.

SUMMARY

- Myoglobin is monomeric; hemoglobin is a tetramer of two subunit types ($\alpha_2\beta_2$ in HbA). Despite having different primary structures, myoglobin and the subunits of hemoglobin have nearly identical secondary and tertiary structures.
- Heme, an essentially planar, slightly puckered, cyclic tetrapyrrole has a central Fe²⁺ linked to all four nitrogen atoms of the heme, to histidine F8, and, in oxyMb and oxyHb, also to O₂.
- The O₂-binding curve for myoglobin is hyperbolic, but for hemoglobin it is sigmoidal, a consequence of cooperative interactions in the tetramer. Cooperativity maximizes the ability of hemoglobin both to load O₂ at the P_{O₂} of the lungs and to deliver O₂ at the P_{O₂} of the tissues.
- Relative affinities of different hemoglobins for oxygen are expressed as P₅₀, the P_{O₂} that half-saturates them with O₂. Hemoglobins saturate at the partial pressures of their respective respiratory organ, for example, the lung or placenta.
- On oxygenation of hemoglobin, the iron and histidine F8 move toward the heme ring. The resulting conformational changes in the hemoglobin tetramer include the rupture of salt bonds and loosening of the quaternary structure that facilitates binding of additional O₂.
- 2,3-BPG in the central cavity of deoxyHb forms salt bonds with the β subunits that stabilize deoxyHb. On oxygenation, the central cavity contracts, BPG is extruded, and the quaternary structure loosens.
- Hemoglobin also functions in CO₂ and proton transport from tissues to lungs. Release of O₂ from oxyHb at the tissues is accompanied by uptake of protons due to lowering of the pK_a of histidine residues.
- In sickle cell hemoglobin (HbS), Val replaces the β 6 Glu of HbA, creating a “sticky patch” that has a complement on deoxyHb (but not on oxyHb). DeoxyHbS polymerizes at low

O₂ concentrations, forming fibers that distort erythrocytes into sickle shapes.

- Alpha and beta thalassemias are anemias that result from reduced production of α and β subunits of HbA, respectively.

REFERENCES

- Cho J, King JS, Qian X, et al: Dephosphorylation of 2,3-bisphosphoglycerate by MIPP expands the regulatory capacity of the Rapoport-Luebering glycolytic shunt. *Proc Natl Acad Sci USA* 2008;105:5998.
- Frauenfelder H, McMahon BH, Fenimore PW: Myoglobin: The hydrogen atom of biology and a paradigm of complexity. *Proc Natl Acad Sci USA* 2003;100:8615.
- Hardison RC, Chui DH, Riemer C, et al: Databases of human hemoglobin variants and other resources at the globin gene server. *Hemoglobin* 2001;25:183.
- Lukin JA, Ho C: The structure–function relationship of hemoglobin in solution at atomic resolution. *Chem Rev* 2004;104:1219.
- Ordway GA, Garry DJ: Myoglobin: An essential hemoprotein in striated muscle. *J Exp Biol* 2004;207:3441.
- Papanikolaou E, Anagnou NP: Major challenges for gene therapy of thalassemia and sickle cell disease. *Curr Gene Ther* 2010;10:404.
- Schrier SL, Angelucci E: New strategies in the treatment of the thalassemias. *Annu Rev Med* 2005;56:157.
- Steinberg MH, Brugnara C: Pathophysiological-based approaches to treatment of sickle-cell disease. *Annu Rev Med* 2003;54:89.
- Umbreit J: Methemoglobin—it’s not just blue: A concise review. *Am J Hematol* 2007;82:134.
- Weatherall DJ, Akinyanju O, Fucharoen S, et al: Inherited disorders of hemoglobin. In: *Disease Control Priorities in Developing Countries*, Jamison DT, Breman JG, Measham AR (editors). Oxford University Press and the World Bank, 2006;663–680.
- Weatherall DJ, Clegg JD: *The Thalassemia Syndromes*. Blackwell Science, 2001.
- Weatherall DJ, Clegg JB, Higgs DR, et al: The hemoglobinopathies. In: *The Metabolic Basis of Inherited Disease*, 8th ed. Scriver CR, Sly WS, Childs B, et al (editors). McGraw-Hill, 2000;4571.
- Yonetani T, Laberge M: Protein dynamics explain the allosteric behaviors of hemoglobin. *Biochim Biophys Acta* 2008;1784:1146.

Enzymes: Mechanism of Action

Peter J. Kennelly, PhD & Victor W. Rodwell, PhD

OBJECTIVES

After studying this chapter, you should be able to:

- Appreciate and describe the structural relationships between specific B vitamins and certain coenzymes.
- Outline the four principal mechanisms by which enzymes achieve catalysis and how these mechanisms combine to facilitate catalysis.
- Describe the concept of an “induced fit” and how it facilitates catalysis.
- Outline the underlying principles of enzyme-linked immunoassays.
- Describe how coupling an enzyme to the activity of a dehydrogenase can simplify assay of the activity of a given enzyme.
- Identify enzymes and proteins whose plasma levels are used for the diagnosis and prognosis of a myocardial infarction.
- Describe the application of restriction endonucleases and of restriction fragment length polymorphisms in the detection of genetic diseases.
- Illustrate the utility of site-directed mutagenesis for the identification of aminoacyl residues that are involved in the recognition of substrates or allosteric effectors, or in the mechanism of catalysis.
- Describe how the addition of fused affinity “tags” via recombinant DNA technology can facilitate purification of a protein expressed from its cloned gene.
- Indicate the function of specific proteases in the purification of affinity-tagged enzymes.
- Discuss the events that led to the discovery that RNAs can act as enzymes, and briefly describe the evolutionary concept of an “RNA world.”

BIOMEDICAL IMPORTANCE

Enzymes, which catalyze the chemical reactions that make life on the earth possible, participate in the breakdown of nutrients to supply energy and chemical building blocks; the assembly of those building blocks into proteins, DNA, membranes, cells, and tissues; and the harnessing of energy to power cell motility, neural function, and muscle contraction. The vast majority of enzymes are proteins. Notable exceptions include ribosomal RNAs and a handful of RNA molecules imbued with endonuclease or nucleotide ligase activity known collectively as ribozymes. The ability to detect and to quantify the activity of specific enzymes in blood, other tissue fluids, or cell extracts provides information that complements the physician’s ability to diagnose and predict the prognosis of many diseases.

Further medical applications include changes in the quantity or in the catalytic activity of key enzymes that can result from genetic defects, nutritional deficits, tissue damage, toxins, or infection by viral or bacterial pathogens (eg, *Vibrio cholerae*). Medical scientists address imbalances in enzyme activity by using pharmacologic agents to inhibit specific enzymes and are investigating gene therapy as a means to remedy deficits in enzyme level or function.

In addition to serving as the catalysts for all metabolic processes, their impressive catalytic activity, substrate specificity, and stereospecificity enable enzymes to fulfill key roles in additional processes related to human health and well-being. Proteases and amylases augment the capacity of detergents to remove dirt and stains, and enzymes play important roles in

producing or enhancing the nutrient value of food products for both humans and animals. The protease rennin, for example, is utilized in the production of cheeses while lactase is employed to remove lactose from milk for the benefit of lactose-intolerant persons deficient in this hydrolytic enzyme. Finally, stereospecific enzyme catalysts can be of particular value in the biosynthesis of complex drugs or antibiotics.

ENZYMES ARE EFFECTIVE & HIGHLY SPECIFIC CATALYSTS

The enzymes that catalyze the conversion of one or more compounds (**substrates**) into one or more different compounds (**products**) generally enhance the rates of the corresponding noncatalyzed reaction by factors of 10^6 or more. Like almost all catalysts, enzymes are neither consumed nor *permanently* altered as a consequence of their participation in a reaction. In addition to being highly efficient, enzymes are also extremely *selective*. Unlike most catalysts used in synthetic chemistry, enzymes are specific not simply for the type of reaction catalyzed, but also for a single substrate or a small set of closely related substrates. Enzymes are also stereospecific catalysts that typically catalyze reactions of only one stereoisomer of a given compound—for example, D- but not L-sugars, L- but not D-amino acids. Since they bind substrates through at least “three points of attachment,” enzymes also can produce chiral products from nonchiral substrates. The cartoon in **Figure 7-1** illustrates why the enzyme-catalyzed reduction of the nonchiral substrate pyruvate can produce exclusively L-lactate, not a racemic mixture of D- and L-lactate. The exquisite specificity of enzyme catalysts imbues living cells with the ability to simultaneously conduct and independently control a broad spectrum of biochemical processes.

ENZYMES ARE CLASSIFIED BY REACTION TYPE

Some of the names for enzymes first described in the earliest days of biochemistry persist in use to this day. Examples include pepsin, trypsin, and amylase. However, in most cases early biochemists designated newly discovered enzymes by first appending the

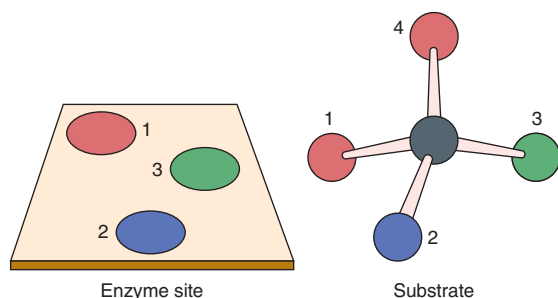

FIGURE 7-1 Planar representation of the “three-point attachment” of a substrate to the active site of an enzyme.

Although atoms 1 and 4 are identical, once atoms 2 and 3 are bound to their complementary sites on the enzyme, only atom 1 can bind. Once bound to an enzyme, apparently identical atoms thus may be distinguishable, permitting a stereospecific chemical change.

suffix *-ase* to a descriptor for the type of reaction catalyzed. For example, enzymes that remove hydrogen atoms are generally referred to as *dehydrogenases*, enzymes that hydrolyze proteins as *proteases*, and enzymes that catalyze rearrangements in configuration as *isomerases*. The process was completed by preceding these general descriptors with terms indicating the substrate on which the enzyme acts (*xanthine oxidase*), its source (*pancreatic ribonuclease*), its mode of regulation (*hormone-sensitive lipase*), or a characteristic feature of its mechanism of action (*cysteine protease*). Where needed, alphanumeric designators are added to identify multiple forms of an enzyme (eg, RNA polymerase *III*; protein kinase *Cβ*).

While simple and straightforward, as more enzymes were discovered these early naming conventions increasingly resulted in the appearance of multiple names for the same enzyme and duplication in the naming of enzymes exhibiting similar catalytic capabilities. To address these problems, the International Union of Biochemistry (IUB) developed an unambiguous system of enzyme nomenclature in which each enzyme has a unique name and code number that identify the *type* of reaction catalyzed and the *substrates* involved. Enzymes are grouped into the following six classes.

1. **Oxidoreductases**—enzymes that catalyze oxidations and reductions.
2. **Transferases**—enzymes that catalyze transfer of moieties such as glycosyl, methyl, or phosphoryl groups.
3. **Hydrolases**—enzymes that catalyze *hydrolytic* cleavage of C—C, C—O, C—N, and other covalent bonds.
4. **Lyases**—enzymes that catalyze cleavage of C—C, C—O, C—N, and other covalent bonds by *atom elimination*, generating double bonds.
5. **Isomerases**—enzymes that catalyze geometric or structural changes *within* a molecule.
6. **Ligases**—enzymes that catalyze the joining together (ligation) of two molecules in reactions coupled to the hydrolysis of ATP.

The IUB name of hexokinase is ATP:D-hexose 6-phosphotransferase E.C. 2.7.1.1. This name identifies hexokinase as a member of class 2 (transferases), subclass 7 (transfer of a phosphoryl group), sub-subclass 1 (alcohol is the phosphoryl acceptor), and “hexose-6” indicates that the alcohol phosphorylated is on carbon six of a hexose. Despite their clarity, IUB names are lengthy and relatively cumbersome, so we generally continue to refer to hexokinase and many other enzymes by their traditional, albeit sometimes ambiguous names. On the other hand E.C. numbers are particularly useful to differentiate enzymes with similar functions or catalytic activities, as illustrated by their utilization in the chapters of Section VI.

PROSTHETIC GROUPS, COFACTORS, & COENZYMES PLAY IMPORTANT ROLES IN CATALYSIS

Many enzymes contain small molecules or metal ions that participate directly in substrate binding or in catalysis. Termed **prosthetic groups**, **cofactors**, and **coenzymes**, they extend the

repertoire of catalytic capabilities beyond those afforded by the limited number of functional groups present on the aminoacyl side chains of peptides.

Prosthetic Groups Are Tightly Integrated Into an Enzyme's Structure

Prosthetic groups are tightly and stably incorporated into a protein's structure by covalent or noncovalent forces. Examples include pyridoxal phosphate, flavin mononucleotide (FMN), flavin adenine dinucleotide (FAD), thiamin pyrophosphate, and biotin. Metal ions constitute the most common type of prosthetic group. The roughly one-third of all enzymes that contain tightly bound Fe, Co, Cu, Mg, Mn, and Zn are termed **metalloenzymes**. Metal ions that participate in redox reactions generally are complexed to prosthetic groups such as heme (Chapters 6 and 31) or iron-sulfur clusters (Chapter 12). Metals also may facilitate the binding and orientation of substrates, the formation of covalent bonds with reaction intermediates (Co^{2+} in coenzyme B_{12} , see Chapter 44), or by acting as Lewis acids or bases to render substrates more **electrophilic** (electron-poor) or **nucleophilic** (electron-rich), and hence more reactive.

Cofactors Associate Reversibly With Enzymes or Substrates

Cofactors can associate either directly with the enzyme or in the form of a cofactor-substrate complex. While cofactors serve functions similar to those of prosthetic groups, they bind in a transient, dissociable manner. Therefore, unlike associated prosthetic groups, cofactors must be present in the medium surrounding the enzyme for catalysis to occur. The most common cofactors also are metal ions. Enzymes that require a metal ion cofactor are termed **metal-activated enzymes** to distinguish them from the **metalloenzymes** for which bound metal ions serve as prosthetic groups.

Many Coenzymes, Cofactors, & Prosthetic Groups Are Derivatives of B Vitamins

The water-soluble B vitamins supply important components of numerous coenzymes. **Nicotinamide** is a component of the redox coenzymes NAD and NADP (Figure 7-2), whereas **riboflavin** is a component of the redox coenzymes FMN and FAD. **Pantothenic acid** is a component of the acyl group carrier **coenzyme A**. As its pyrophosphate, **thiamin** participates in decarboxylation of α -keto acids, and the **folic acid** and **cobamide** coenzymes function in one-carbon metabolism. In addition, several coenzymes contain the adenine, ribose, and phosphoryl moieties of AMP or ADP (Figure 7-2).

Coenzymes Serve as Substrate Shuttles

Coenzymes serve as recyclable shuttles that transport many substrates from one point within the cell to another. The function of these shuttles is twofold. First, they stabilize species

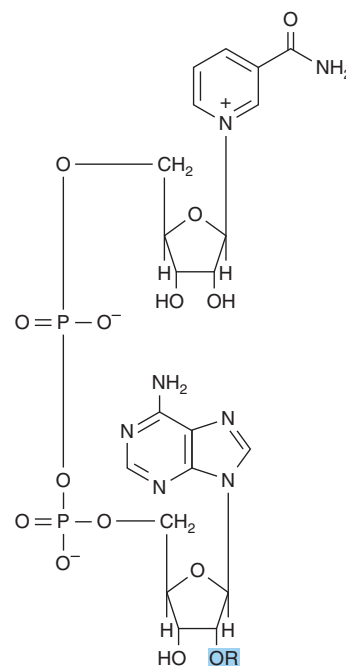

FIGURE 7-2 Structure of NAD⁺ and NADP⁺. For NAD⁺, OR = -OH. For NADP⁺, -OR = -OPO₃²⁻.

such as hydrogen atoms (FADH) or hydride ions (NADH) that are too reactive to persist for any significant time in the presence of the water or organic molecules that permeate cells. Second, they serve as an adaptor or handle that facilitates the recognition and binding of small chemical groups, such as acetate (coenzyme A) or glucose (UDP), by their target enzymes. Other chemical moieties transported by coenzymes include methyl groups (folates) and oligosaccharides (dolichol).

CATALYSIS OCCURS AT THE ACTIVE SITE

An important early 20th-century insight into enzymic catalysis sprang from the observation that the presence of substrates renders enzymes more resistant to the denaturing effects of an elevated temperature. This observation led Emil Fischer to propose that enzymes and their substrates interact to form an enzyme-substrate (ES) complex whose thermal stability was greater than that of the enzyme itself. This insight profoundly shaped our understanding of both the chemical nature and kinetic behavior of enzymic catalysis.

Fischer reasoned that the exquisitely high specificity with which enzymes discriminate their substrates when forming an ES complex was analogous to the manner in which a mechanical lock distinguishes the proper key. The analogy to enzymes is that the “lock” is formed by a cleft or pocket on the surface of the enzyme called the **active site** (Figures 5-6 and 5-8). As implied by the adjective “active,” the active site is much more than simply a recognition site for binding substrates; it provides the environment wherein chemical transformation

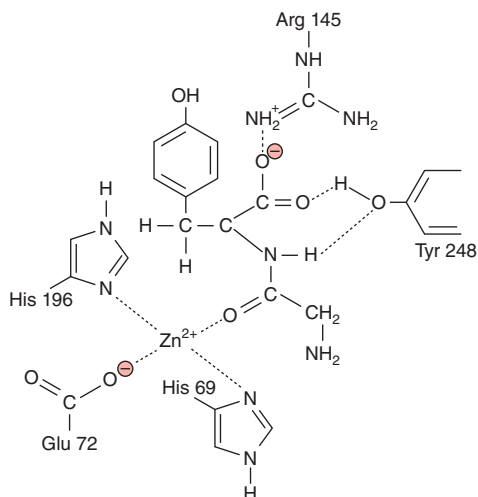

FIGURE 7-3 Two-dimensional representation of a dipeptide substrate, glycyl-tyrosine, bound within the active site of carboxypeptidase A.

takes place. Within the active site, substrates are brought into close proximity to one another in optimal alignment with the cofactors, prosthetic groups, and amino acid side chains that participate in catalyzing the transformation of substrates into products (Figure 7-3). Catalysis is further enhanced by the capacity of the active site to shield substrates from water and generate an environment whose polarity, hydrophobicity, acidity, or alkalinity can differ markedly from that of the surrounding cytoplasm.

ENZYMES EMPLOY MULTIPLE MECHANISMS TO FACILITATE CATALYSIS

Enzymes use combinations of four general mechanisms to achieve dramatic enhancements of the rates of chemical reactions.

Catalysis by Proximity

For molecules to interact, they must come within bond-forming distance of one another. The higher their concentration, the more frequently they will encounter one another, and the greater will be the rate of their reaction. When an enzyme binds substrate molecules at its active site, it creates a region of high local substrate concentration in which the substrate molecules are oriented in a position ideal for them to chemically interact. This results in rate enhancements of at least a thousandfold over the same non-enzyme-catalyzed reaction.

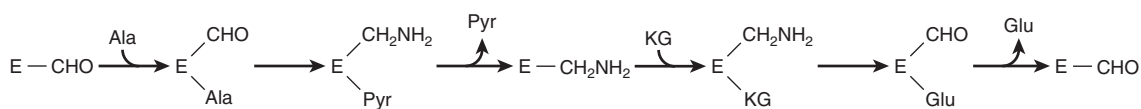

FIGURE 7-4 “Ping-pong” mechanism for transamination. E—CHO and E—CH₂NH₂ represent the enzyme-pyridoxal phosphate and enzyme-pyridoxamine complexes, respectively. (Ala, alanine; Glu, glutamate; KG, α-ketoglutarate; Pyr, pyruvate.)

Acid-Base Catalysis

In addition to contributing to the ability of the active site to bind substrates, the ionizable functional groups of aminoacyl side chains, and where present of prosthetic groups, can contribute to catalysis by acting as acids or bases. We distinguish two types of acid-base catalysis. **Specific acid or base catalysis** refers to reactions for which the only *participating* acid or base are protons or hydroxide ions. The rate of reaction thus is sensitive to changes in the concentration of protons or hydroxide ions, but is *independent* of the concentrations of other acids (proton donors) or bases (proton acceptors) present in the solution or at the active site. Reactions whose rates are responsive to *all* the acids or bases present are said to be subject to **general acid catalysis** or **general base catalysis**.

Catalysis by Strain

Enzymes that catalyze *lytic* reactions, chemical transformations that involve breaking a covalent bond, typically bind their substrates in a conformation that is somewhat unfavorable for the bond targeted for cleavage. This strained conformation mimics that of the **transition state intermediate**, a transient species that represents the transition state, or midway point, in the transformation of substrates to products. The resulting strain selectively stretches or distorts the targeted bond, weakening it and making it more vulnerable to cleavage. Nobel Laureate Linus Pauling was the first to suggest a role for **transition state stabilization** as a general mechanism by which enzymes accelerate the rates of chemical reactions. Knowledge of the transition state of an enzyme-catalyzed reaction is frequently exploited by chemists to design and create more effective enzyme inhibitors, called **transition state analogs**, as potential pharmacophores.

Covalent Catalysis

The process of **covalent catalysis** involves the formation of a covalent bond between the enzyme and one or more substrates. The modified enzyme thus becomes a reactant. Covalent catalysis introduces a new reaction pathway whose activation energy is lower—and the reaction therefore is faster—than the reaction pathway in homogeneous solution. The chemically modified state of the enzyme is, however, transient. Completion of the reaction returns the enzyme to its original, unmodified state. Its role thus remains catalytic. Covalent catalysis is particularly common among enzymes that catalyze **group transfer reactions**. Residues on the enzyme that participate in covalent catalysis generally are cysteine or serine, and occasionally histidine. Covalent catalysis often follows a “ping-pong” mechanism—one in which the first substrate is bound and its product released prior to the binding of the second substrate (Figure 7-4).

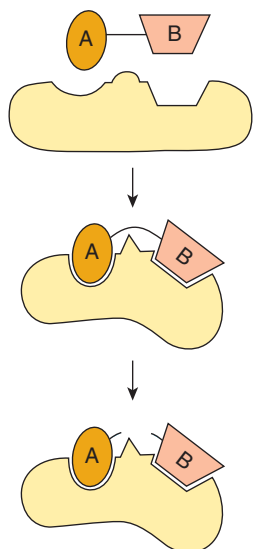

FIGURE 7-5 Two-dimensional representation of Koshland's induced fit model of the active site of a lyase. Binding of the substrate A—B induces conformational changes in the enzyme that align catalytic residues which participate in catalysis and strain the bond between A and B, facilitating its cleavage.

SUBSTRATES INDUCE CONFORMATIONAL CHANGES IN ENZYMES

While Fischer's "lock and key model" accounted for the exquisite specificity of enzyme-substrate interactions, the implied rigidity of the enzyme's active site failed to account for the dynamic changes that accompany substrate binding and catalysis. This drawback was addressed by Daniel Koshland's **induced fit model**, which states that when substrates approach and bind to an enzyme they induce a conformational change that is analogous to placing a hand (substrate) into a glove (enzyme) (**Figure 7-5**). The enzyme in turn induces reciprocal changes in its substrates, harnessing the energy of binding to facilitate the transformation of substrates into products. The induced fit model has been amply confirmed by biophysical studies of enzyme motion during substrate binding.

HIV PROTEASE ILLUSTRATES ACID-BASE CATALYSIS

Enzymes of the **aspartic protease family**, which includes the digestive enzyme pepsin, the lysosomal cathepsins, and the protease produced by the human immunodeficiency virus (HIV) share a common mechanism that employs two conserved aspartyl residues as acid-base catalysts. In the first stage of the reaction, an aspartate functioning as a general base (Asp X, **Figure 7-6**) extracts a proton from a water molecule, making it more nucleophilic. The resulting nucleophile then attacks the electrophilic carbonyl carbon of the peptide bond targeted for hydrolysis, forming a **tetrahedral transition state intermediate**. A second aspartate (Asp Y, **Figure 7-6**) then facilitates the decomposition of this tetrahedral intermediate by donating a proton to

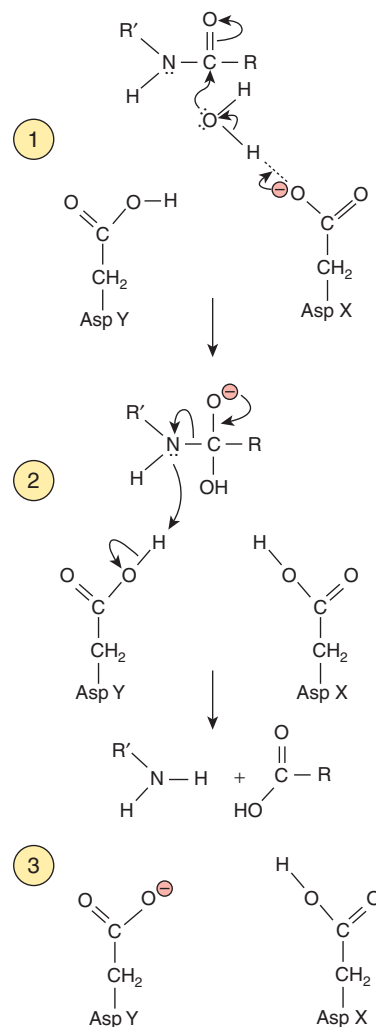

FIGURE 7-6 Mechanism for catalysis by an aspartic protease such as HIV protease. Curved arrows indicate directions of electron movement. ① Aspartate X acts as a base to activate a water molecule by abstracting a proton. ② The activated water molecule attacks the peptide bond, forming a transient tetrahedral intermediate. ③ Aspartate Y acts as an acid to facilitate breakdown of the tetrahedral intermediate and release of the split products by donating a proton to the newly formed amino group. Subsequent shuttling of the proton on Asp X to Asp Y restores the protease to its initial state.

the amino group produced by rupture of the peptide bond. The two active site aspartates can act simultaneously as a general base or as a general acid because their immediate environment favors ionization of one, but not the other.

CHYMOTRYPSIN & FRUCTOSE-2,6-BISPHOSPHATASE ILLUSTRATE COVALENT CATALYSIS

Chymotrypsin

While catalysis by aspartic proteases involves the direct hydrolytic attack of water on a peptide bond, catalysis by the **serine protease** chymotrypsin involves formation of a covalent acyl-enzyme intermediate. A conserved serine residue, serine 195, is activated via interactions with histidine 57 and aspartate 102.

While these three residues are far apart in primary structure, in the active site of the mature, folded protein they reside within bond-forming distance of one another. Aligned in the order Asp 102-His 57-Ser 195, this trio forms a linked **charge-relay network** that acts as a “**proton shuttle**.”

Binding of substrate initiates proton shifts that in effect transfer the hydroxyl proton of Ser 195 to Asp 102 (Figure 7-7). The

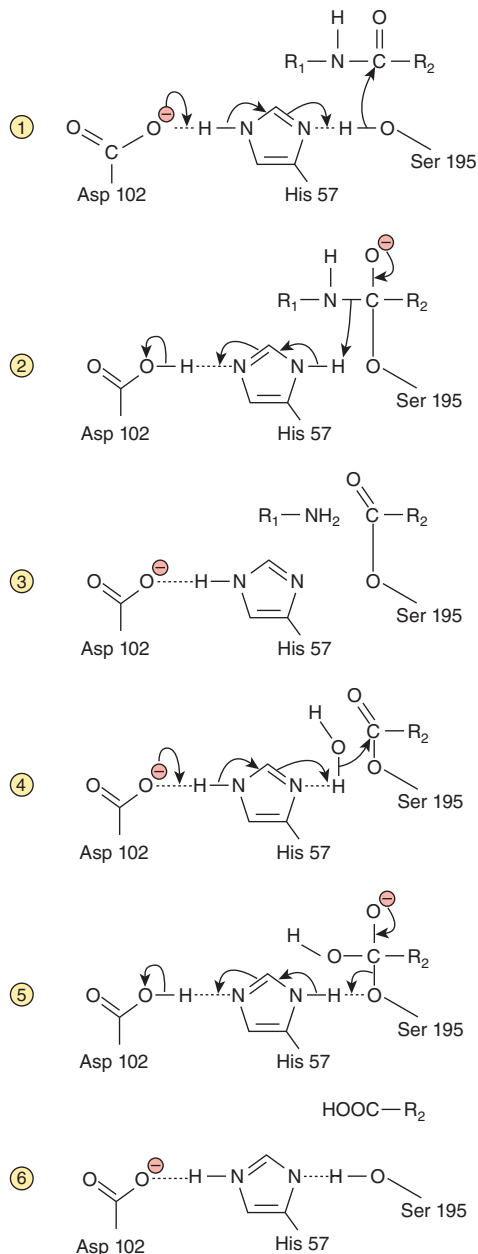

FIGURE 7-7 Catalysis by chymotrypsin. ① The charge-relay system removes a proton from Ser 195, making it a stronger nucleophile. ② Activated Ser 195 attacks the peptide bond, forming a transient tetrahedral intermediate. ③ Release of the amino terminal peptide is facilitated by donation of a proton to the newly formed amino group by His 57 of the charge-relay system, yielding an acyl-Ser 195 intermediate. ④ His 57 and Asp 102 collaborate to activate a water molecule, which attacks the acyl-Ser 195, forming a second tetrahedral intermediate. ⑤ The charge-relay system donates a proton to Ser 195, facilitating breakdown of the tetrahedral intermediate to release the carboxyl terminal peptide ⑥.

enhanced nucleophilicity of the seryl oxygen facilitates its attack on the carbonyl carbon of the peptide bond of the substrate, forming a covalent **acyl-enzyme intermediate**. The proton on Asp 102 then shuttles via His 57 to the amino group liberated when the peptide bond is cleaved. The portion of the original peptide with a free amino group then leaves the active site and is replaced by a water molecule. The charge-relay network now activates the water molecule by withdrawing a proton through His 57 to Asp 102. The resulting hydroxide ion attacks the acyl-enzyme intermediate, and a reverse proton shuttle returns a proton to Ser 195, restoring its original state. While modified during the process of catalysis, chymotrypsin emerges unchanged on completion of the reaction. The proteases trypsin and elastase employ a similar catalytic mechanism, but the numbering of the residues in their Ser-His-Asp proton shuttles differ.

Fructose-2,6-Bisphosphatase

Fructose-2,6-bisphosphatase, a regulatory enzyme of gluconeogenesis (see Chapter 19), catalyzes the hydrolytic release of the phosphate on carbon 2 of fructose-2,6-bisphosphate. **Figure 7-8** illustrates the roles of seven active site residues. Catalysis involves a “catalytic triad” of one Glu and two His residues and a covalent phosphohistidyl intermediate.

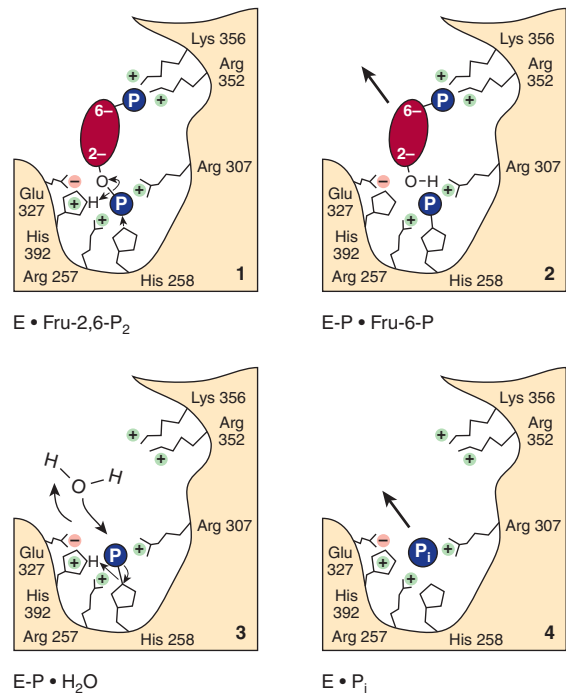

FIGURE 7-8 Catalysis by fructose-2,6-bisphosphatase. (1) Lys 356 and Arg 257, 307, and 352 stabilize the quadruple negative charge of the substrate by charge-charge interactions. Glu 327 stabilizes the positive charge on His 392. (2) The nucleophile His 392 attacks the C-2 phosphoryl group and transfers it to His 258, forming a phosphohistidyl intermediate. Fructose-6-phosphate now leaves the enzyme. (3) Nucleophilic attack by a water molecule, possibly assisted by Glu 327 acting as a base, forms inorganic phosphate. (4) Inorganic orthophosphate is released from Arg 257 and Arg 307. (Reproduced, with permission, from Pilkis SJ, et al: 6-Phosphofructo-2-kinase/fructose-2,6-bisphosphatase: A metabolic signaling enzyme. *Annu Rev Biochem* 1995;64:799. © 1995 by Annual Reviews, www.annualreviews.org.)

TABLE 7-1 Amino Acid Sequences in the Neighborhood of the Catalytic Sites of Several Bovine Proteases

Enzyme	Sequence Around Serine (S)	Sequence Around Histidine (H)
Trypsin	D S C Q D G (S) G G P V V C S G	K V V S A A (H) C Y K S G
Chymotrypsin A	S S C M G D (S) G G P L V C K K	N V V T A A (H) G G V T T
Chymotrypsin B	S S C M G D (S) G G P L V C Q K	N V V T A A (H) C G V T T
Thrombin	D A C E G D (S) G G P F V M K S	P V L T A A (H) C L L Y P

Note: Regions shown are those on either side of the catalytic site seryl (S) and histidyl (H) residues.

CATALYTIC RESIDUES ARE HIGHLY CONSERVED

Members of an enzyme family such as the aspartic or serine proteases employ a similar mechanism to catalyze a common reaction type, but act on different substrates. Most enzyme families appear to have arisen through gene duplication events that created a second copy of the gene that encodes a particular enzyme. The two genes, and consequently their encoded proteins, can then evolve independently, forming divergent **homologs** that recognize different substrates. The result is illustrated by chymotrypsin, which cleaves peptide bonds on the carboxyl terminal side of large hydrophobic amino acids, and trypsin, which cleaves peptide bonds on the carboxyl terminal side of basic amino acids. Proteins that diverged from a common ancestor are said to be **homologous** to one another. The common ancestry of enzymes can be inferred from the presence of specific amino acids in the same relative position in each family member. These residues are said to be **conserved residues**. Table 7-1 illustrates the primary structural conservation of two components of the charge-relay network for several serine proteases. Among the most highly conserved residues are those that participate directly in catalysis.

ISOZYMES ARE DISTINCT ENZYME FORMS THAT CATALYZE THE SAME REACTION

Higher organisms often elaborate several physically distinct versions of a given enzyme, each of which catalyzes the same reaction. Like the members of other protein families, these protein catalysts or **isozymes** arise through gene duplication. While the proteases described above have different substrates, isozymes may possess subtle differences in properties such as sensitivity to particular regulatory factors (see Chapter 9) or substrate affinity (eg, hexokinase and glucokinase) that adapt them to specific tissues or circumstances rather than distinct substrate specificities. Isozymes that catalyze the identical reaction may also enhance survival by providing a “backup” copy of an essential enzyme.

THE CATALYTIC ACTIVITY OF ENZYMES FACILITATES THEIR DETECTION

The relatively small quantities of enzymes present in cells hamper determination of their presence and concentration. However, the amplification conferred by their ability to rapidly transform thousands of molecules of a specific substrate into products imbues each enzyme with the ability to reveal its presence. Assays of the catalytic activity of enzymes are frequently used in research and clinical laboratories. Under appropriate conditions (see Chapter 8), the rate of the catalytic reaction being monitored is proportionate to the amount of enzyme present, which allows its concentration to be inferred.

Single-Molecule Enzymology

The limited sensitivity of traditional enzyme assays necessitates the use of a large group, or ensemble, of enzyme molecules in order to produce measurable quantities of product. The data obtained thus reflect the *average* activity of individual enzymes across multiple cycles of catalysis. Recent advances in **nanotechnology** have made it possible to observe, often by fluorescence microscopy, catalytic events involving individual enzyme and substrate molecules. Consequently, scientists can now measure the rate of single catalytic events and sometimes the individual steps in catalysis by a process called **single-molecule enzymology**, an example of which is illustrated in Figure 7-9.

Drug Discovery Requires Enzyme Assays Suitable for High-Throughput Screening

Enzymes constitute one of the primary classes of biomolecules targeted for the development of drugs and other therapeutic agents. Many antibiotics, for example, inhibit enzymes that are unique to microbial pathogens. The discovery of new drugs is greatly facilitated when a large number of potential pharmacophores can be simultaneously assayed in a rapid, automated fashion—a process referred to as **high-throughput screening**. High-throughput screening (HTS) takes advantage of robotics, optics, data processing, and microfluidics to conduct and

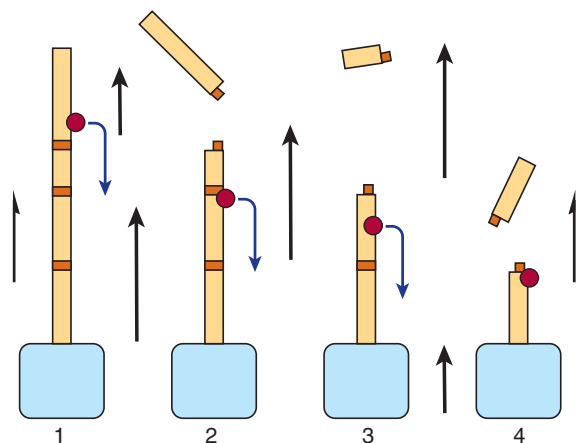

FIGURE 7-9 Direct observation of single DNA cleavage events catalyzed by a restriction endonuclease. DNA molecules immobilized to beads (blue) are placed in a flowing stream of buffer (black arrows), which causes them to assume an extended conformation. Cleavage at one of the restriction sites (orange) by an endonuclease leads to a shortening of the DNA molecule, which can be observed directly in a microscope since the nucleotide bases in DNA are fluorescent. Although the endonuclease (red) does not fluoresce, and hence is invisible, the progressive manner in which the DNA molecule is shortened (1→4) reveals that the endonuclease binds to the free end of the DNA molecule and moves along it from site to site.

analyze many thousands of assays of the activity of a given enzyme simultaneously. The most commonly used high-throughput screening devices employ 4 to 100 μL volumes in 96, 384, or 1536 well plastic plates and fully automated equipment capable of dispensing substrates, coenzymes, enzymes, and potential inhibitors in a multiplicity of combinations and concentrations. High-throughput screening is ideal for surveying the numerous products of **combinatorial chemistry**, the simultaneous synthesis of large libraries of chemical compounds that contain all possible combinations of a set of chemical precursors. Enzyme assays that produce a chromogenic or fluorescent product are ideal, since optical detectors are readily engineered to permit the rapid analysis of multiple samples, often in real time. As described in Chapter 8, the principal use is the analysis of inhibitory compounds with ultimate potential for use as drugs.

Enzyme-Linked Immunoassays

The sensitivity of enzyme assays can be exploited to detect proteins that lack catalytic activity. **Enzyme-linked immunosorbent assays** (ELISAs) use antibodies covalently linked to a “reporter enzyme” such as alkaline phosphatase or horseradish peroxidase whose products are readily detected, generally by the absorbance of light or by fluorescence. Serum or other biologic samples to be tested are placed in plastic, multi-well microtiter plates, where the proteins adhere to the plastic surface and are immobilized. Any exposed plastic that remains is subsequently “blocked” by adding a nonantigenic

protein such as bovine serum albumin. A solution of antibody covalently linked to a reporter enzyme is then added. The antibodies adhere to the immobilized antigen and are themselves immobilized. Excess free antibody molecules are then removed by washing. The presence and quantity of bound antibody is then determined by adding the substrate for the reporter enzyme.

NAD(P)⁺-Dependent Dehydrogenases Are Assayed Spectrophotometrically

The physicochemical properties of the reactants in an enzyme-catalyzed reaction dictate the options for the assay of enzyme activity. Spectrophotometric assays exploit the ability of a substrate or product to absorb light. The reduced coenzymes NADH and NADPH, written as NAD(P)H, absorb light at a wavelength of 340 nm, whereas their oxidized forms NAD(P)⁺ do not (**Figure 7-10**). When NAD(P)⁺ is reduced, the absorbance at 340 nm therefore increases in proportion to—and at a rate determined by—the quantity of NAD(P)H produced. Conversely, for a dehydrogenase that catalyzes the oxidation of NAD(P)H, a decrease in absorbance at 340 nm will be observed. In each case, the rate of change in absorbance at 340 nm will be proportionate to the quantity of the enzyme present.

The assay of enzymes whose reactions are not accompanied by a change in absorbance or fluorescence is generally more difficult. In some instances, either the product or remaining substrate can be transformed into a more readily detected compound, although the reaction product may have to be separated from unreacted substrate prior to measurement. An alternative strategy is to devise a synthetic substrate whose product absorbs light or fluoresces. For example, hydrolysis of the phosphoester bond in *p*-nitrophenyl phosphate (*p*NPP),

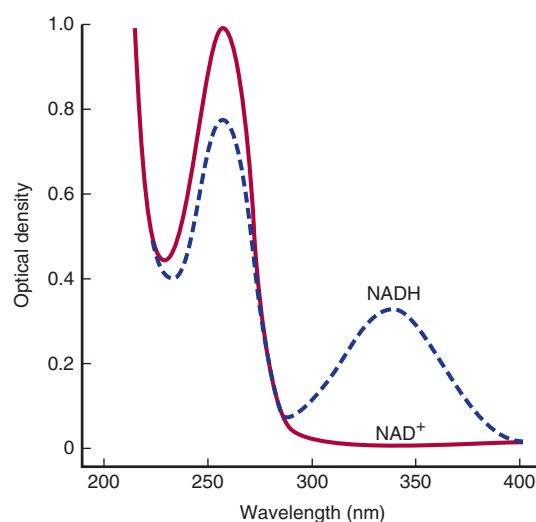

FIGURE 7-10 Absorption spectra of NAD⁺ and NADH. Densities are for a 44-mg/L solution in a cell with a 1-cm light path. NAD⁺ and NADPH have spectra analogous to NAD⁺ and NADH, respectively.

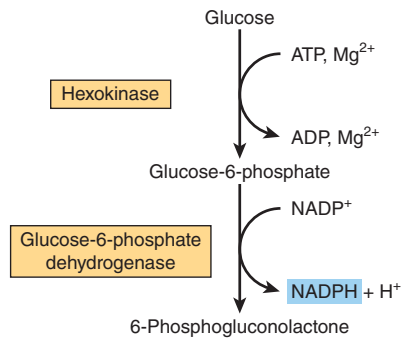

FIGURE 7-11 Coupled enzyme assay for hexokinase activity. The production of glucose-6-phosphate by hexokinase is coupled to the oxidation of this product by glucose-6-phosphate dehydrogenase in the presence of added enzyme and NADP⁺. When an excess of glucose-6-phosphate dehydrogenase is present, the rate of formation of NADPH, which can be measured at 340 nm, is governed by the rate of formation of glucose-6-phosphate by hexokinase.

an artificial substrate molecule, is catalyzed at a measurable rate by numerous phosphatases, phosphodiesterases, and serine proteases. While *p*NPP does not absorb visible light, following its hydrolysis the resulting *p*-nitrophenylate anion absorbs light at 419 nm, and thus can be quantified.

Many Enzymes Are Assayed by Coupling to a Dehydrogenase

Another quite general approach is to employ a “coupled” assay (Figure 7-11). Typically, a dehydrogenase whose substrate is the product of the enzyme of interest is added in catalytic excess. The rate of appearance or disappearance of NAD(P)H then depends on the rate of the enzyme reaction to which the dehydrogenase has been coupled.

THE ANALYSIS OF CERTAIN ENZYMES AIDS DIAGNOSIS

The analysis of enzymes in blood plasma has played a central role in the diagnosis of several disease processes. Many enzymes are functional constituents of blood. Examples include pseudocholinesterase, lipoprotein lipase, and components of the cascades that trigger blood clotting and clot dissolution. Other enzymes are released into plasma following cell death or injury. While these latter enzymes perform no physiologic function in plasma, they can serve as **biomarkers**, molecules whose appearance or levels can assist in the diagnosis and prognosis of diseases and injuries affecting specific tissues. Following injury, the plasma concentration of a released enzyme may rise early or late, and may decline rapidly or slowly. Proteins resident to the cytoplasm tend to appear more rapidly than those from subcellular organelles. Factors that determine the speed with which enzymes and other proteins are removed from plasma include their susceptibility to proteolysis and their permeability to renal glomeruli.

TABLE 7-2 Principal Serum Enzymes Used in Clinical Diagnosis

Serum Enzyme	Major Diagnostic Use
Aminotransferases	
Aspartate aminotransferase (AST, or SGOT)	Myocardial infarction
Alanine aminotransferase (ALT, or SGPT)	Viral hepatitis
Amylase	Acute pancreatitis
Ceruloplasmin	Hepatolenticular degeneration (Wilson disease)
Creatine kinase	Muscle disorders and myocardial infarction
γ-Glutamyl transferase	Various liver diseases
Lactate dehydrogenase isozyme 5	Liver diseases
Lipase	Acute pancreatitis
β-Glucocerebrosidase	Gaucher disease
Phosphatase, alkaline (isozymes)	Various bone disorders, obstructive liver diseases

Note: Many of the above enzymes are not specific to the disease listed.

Quantitative analysis of the activity of released enzymes or other proteins, typically in plasma or serum but also in urine or various cells, provides information concerning diagnosis, prognosis, and response to treatment. Assays of enzyme *activity* typically employ standard kinetic assays of initial reaction rates. Table 7-2 lists several enzymes of value in clinical diagnosis. These enzymes are, however, not absolutely specific for the indicated disease. For example, elevated blood levels of prostatic acid phosphatase are associated typically with prostate cancer, but also may occur with certain other cancers and non-cancerous conditions. Consequently, enzyme assay data must be considered together with other factors elicited through a comprehensive clinical examination. Factors to be considered in interpreting enzyme data include patient age, sex, prior history, possible drug use, and the sensitivity and the diagnostic specificity of the enzyme test.

Enzymes Assist Diagnosis of Myocardial Infarction

An enzyme useful for diagnostic enzymology should be relatively specific for the tissue or organ under study, should appear in the plasma or other fluid at a time useful for diagnosis (the “diagnostic window”), and should be amenable to automated assay. The enzymes used to confirm a myocardial infarction (MI) illustrate the concept of a “diagnostic window,” and provide a historical perspective on the use of different enzymes for this purpose.

Detection of an enzyme must be possible within a few hours of an MI to confirm a preliminary diagnosis and permit

initiation of appropriate therapy. Enzymes that only appear in the plasma for 12 hours or more following injury are thus of limited utility. The first enzymes used to diagnose MI were aspartate aminotransferase (AST), alanine aminotransferase (ALT), and lactate dehydrogenase. AST and ALT proved less than ideal, however, as they appear in plasma relatively slowly and are not specific to heart muscle. While LDH also is released relatively slowly into plasma, it offered the advantage of tissue specificity as a consequence of its quaternary structure.

Lactate dehydrogenase (LDH) is a tetrameric enzyme consisting of two monomer types: H (for heart) and M (for muscle) that combine to yield five LDH isozymes: H₄ (I₁), H₃M (I₂), H₂M₂ (I₃), HM₃ (I₄), and M₄ (I₅). The relative proportions of each subunit in the cells of a particular organ is determined by tissue-specific patterns in the expression of the H and M genes. Isozyme I₁ predominates in heart tissue, and isozyme I₅ in the liver. Thus, when LDH levels rise in blood plasma, the identity of the injured tissue can be inferred from its characteristic pattern of LDH isozymes. In the clinical laboratory, individual isozymes can be separated by electrophoresis and detected using a coupled assay (Figure 7-12). While historically of importance, the assay of LDH has been superseded as a marker for MI by proteins that appear in plasma more rapidly than LDH.

Creatine kinase (CK) has three isozymes: CK-MM (skeletal muscle), CK-BB (brain), and CK-MB (heart and skeletal muscle). CK-MB has a useful diagnostic window. It appears within 4 to 6 hours of an MI, peaks at 24 hours, and returns to a baseline level by 48 to 72 hours. As for LDH, individual CK isozymes are separable by electrophoresis, thus facilitating detection. Assay of plasma CK levels continues in use to assess skeletal muscle disorders such as Duchene muscular dystrophy. Today, however, in most clinical laboratories

the measurement of plasma troponin levels has replaced CK as the preferred diagnostic marker for MI.

Troponins

Troponin is a complex of three proteins involved in muscle contraction in *skeletal* and *cardiac muscle* but not in *smooth muscle* (see Chapter 51). Immunological measurement of plasma levels of cardiac troponins I and T provide sensitive and specific indicators of damage to heart muscle. Troponin levels rise for 2 to 6 hours after an MI and remain elevated for 4 to 10 days. In addition to MI, other heart muscle damage also elevates serum troponin levels. Cardiac troponins thus serve as a marker of all heart muscle damage. The search for additional markers for heart disease, such as ischemia-modified albumin, and the simultaneous assessment of a spectrum of diagnostic markers via proteomics, continues to be an active area of clinical research.

Additional Clinical Uses of Enzymes

Enzymes also can be employed in the clinical laboratory as tools for determining the concentration of critical metabolites. For example, glucose oxidase is frequently utilized to measure plasma glucose concentration. Enzymes are employed with increasing frequency as tools for the treatment of injury and disease. Tissue plasminogen activator (tPA) or streptokinase is used in the treatment of acute MI, while trypsin has been used in the treatment of cystic fibrosis. Intravenous infusion of recombinantly produced glycosylases has been approved for the treatment of several lysosomal storage diseases including the Gaucher disease (β -glucosidase), Pompe disease (α -glucosidase), Fabry disease (α -galactosidase A), and Sly disease (β -glucuronidase).

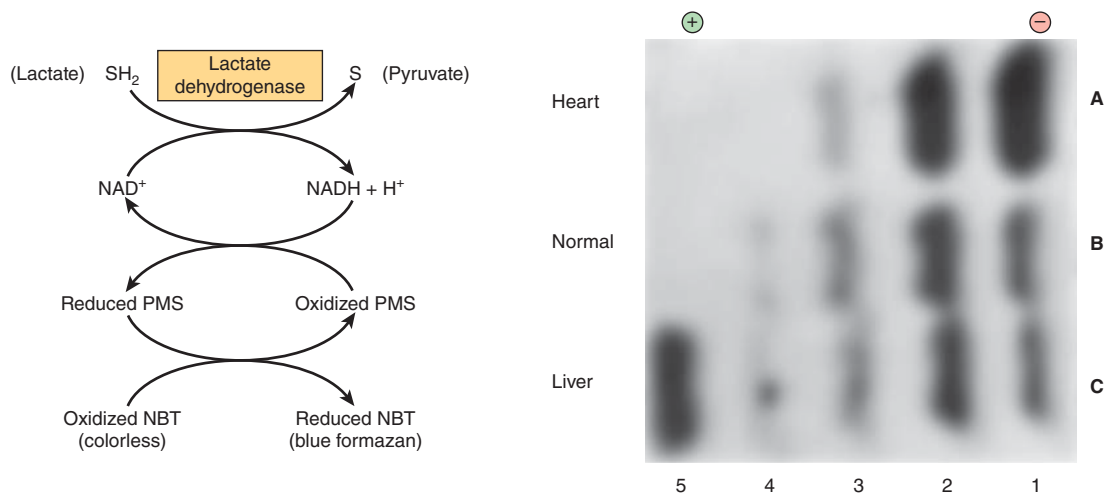

FIGURE 7-12 Normal and pathologic patterns of lactate dehydrogenase (LDH) isozymes in human serum. LDH isozymes of serum were separated by electrophoresis and visualized using the coupled reaction scheme shown on the left. (NBT, nitroblue tetrazolium; PMS, phenazine methosulfate.) At right is shown the stained electropherogram. Pattern A is serum from a patient with a myocardial infarct; B is normal serum; and C is serum from a patient with liver disease. Arabic numerals denote specific LDH isozymes.

ENZYMES FACILITATE DIAGNOSIS OF GENETIC AND INFECTIOUS DISEASES

Many diagnostic techniques take advantage of the specificity and efficiency of the enzymes that act on oligonucleotides such as DNA. Enzymes known as **restriction endonucleases**, for example, cleave double-stranded DNA at sites specified by a sequence of four, six, or more base pairs called **restriction sites**. Cleavage of a sample of DNA with a restriction enzyme produces a characteristic set of smaller DNA fragments (see Chapter 39). Deviations in the normal product pattern, called **restriction fragment length polymorphisms (RFLPs)**, occur if a mutation renders a restriction site unrecognizable to its cognate restriction endonuclease or, alternatively, generates a new recognition site. RFLPs are currently utilized to facilitate prenatal detection of a number of hereditary disorders, including sickle cell trait, β -thalassemia, infant phenylketonuria, and Huntington disease.

Medical Applications of the Polymerase Chain Reaction

As described in Chapter 39, the **polymerase chain reaction (PCR)** employs a thermostable DNA polymerase and appropriate oligonucleotide primers to produce thousands of copies of a defined segment of DNA from a minute quantity of starting material. PCR enables medical, biological, and forensic scientists to detect and characterize DNA present initially at levels too low for direct detection. In addition to screening for genetic mutations, PCR can be used to detect and identify pathogens and parasites such as *Trypanosoma cruzi*, the causative agent of Chagas disease, and *Neisseria meningitidis*, the causative agent of bacterial meningitis, through the selective amplification of their DNA.

RECOMBINANT DNA PROVIDES AN IMPORTANT TOOL FOR STUDYING ENZYMES

Recombinant DNA technology has emerged as an important asset in the study of enzymes. Highly purified samples of enzymes are necessary for the study of their structure and function. The isolation of an individual enzyme, particularly one present in low concentration, from among the thousands of proteins present in a cell can be extremely difficult. By cloning the gene for the enzyme of interest, it generally is possible to produce large quantities of its encoded protein in *Escherichia coli* or yeast. However, not all animal proteins can be expressed in an active form in microbial cells, nor do microbes perform certain posttranslational processing tasks. For these reasons, a gene may be expressed in cultured animal cell systems or by employing the baculovirus expression vector to transform cultured insect cells. For more details concerning recombinant DNA techniques, see Chapter 39.

Recombinant Fusion Proteins Are Purified by Affinity Chromatography

Recombinant DNA technology can also be used to create modified proteins that are readily purified by affinity chromatography. The gene of interest is linked to an oligonucleotide sequence that encodes a carboxyl or amino terminal extension to the encoded protein. The resulting modified protein, termed a **fusion protein**, contains a new domain tailored to interact with an appropriately modified affinity support. One popular approach is to attach an oligonucleotide that encodes six consecutive histidine residues. The expressed “His tag” protein binds to chromatographic supports that contain an immobilized divalent metal ion such as Ni^{2+} or Cd^{2+} . This approach exploits the ability of these divalent cations to bind His residues. Once bound, contaminating proteins are washed off, and the His-tagged enzyme is eluted with buffers containing high concentrations of free histidine or imidazole, which compete with the polyhistidine tails for binding to the immobilized metal ions. Alternatively, the substrate-binding domain of glutathione S-transferase (GST) can serve as a “GST tag.” **Figure 7–13** illustrates the purification of a GST-fusion protein using an affinity support containing bound glutathione. Most fusion domains also possess a cleavage site for a highly specific protease such as thrombin in the region that links the two portions of the protein. This permits removal of the added fusion domain following affinity purification.

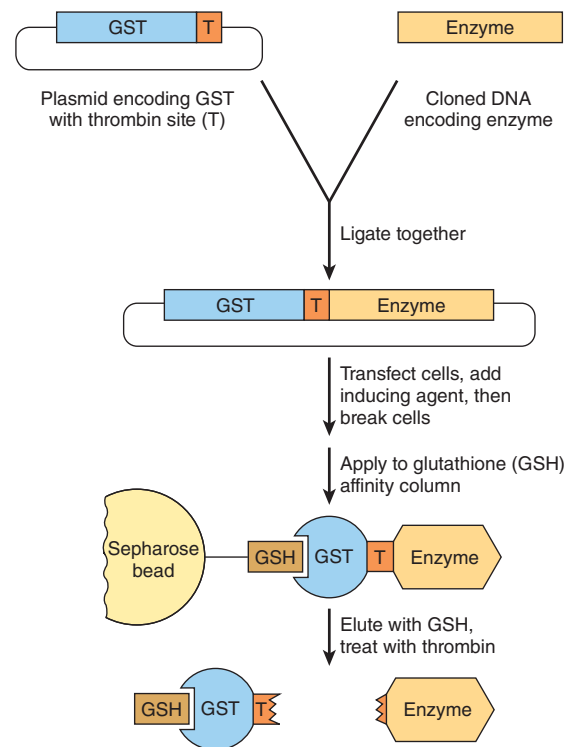

FIGURE 7–13 Use of glutathione S-transferase (GST) fusion proteins to purify recombinant proteins. (GSH, glutathione.)

Site-Directed Mutagenesis Provides Mechanistic Insights

Once the ability to express a protein from its cloned gene has been established, it is possible to employ **site-directed mutagenesis** to change specific aminoacyl residues by altering their codons. Used in combination with kinetic analyses and x-ray crystallography, this approach facilitates identification of the specific roles of given aminoacyl residues in substrate binding and catalysis. For example, the inference that a particular aminoacyl residue functions as a general acid can be tested by replacing it with an aminoacyl residue incapable of donating a proton.

RIBOZYMES: ARTIFACTS FROM THE RNA WORLD

Cech Discovered the First Catalytic RNA Molecule

The participation of enzyme catalysts in the posttranslational maturation of certain proteins has analogies in the RNA world. Many RNA molecules undergo processing that removes segments of oligonucleotide and re-ligates the remaining segments to form the mature product (see Chapter 36). Not all of these catalysts are proteins, however. While examining the processing of ribosomal RNA (rRNA) molecules in the ciliated protozoan *Tetrahymena*, Thomas Cech and his coworkers observed, in the early 1980s, that processing of the 26S rRNA proceeded smoothly *in vitro* even in the total *absence* of protein. The source of this splicing activity was traced to a 413 bp catalytic segment that retained its catalytic activity even when replicated in *E coli* (see Chapter 39). Prior to that time, it had been thought that polynucleotides served solely as information storage and transmission entities, and that catalysis was restricted solely to proteins.

Several other ribozymes have since been discovered. The vast majority catalyze nucleophilic displacement reactions that target the phosphodiester bonds of the RNA backbone. In small self-cleaving RNAs, such as hammerhead or hepatitis delta virus RNA, the attacking nucleophile is water and the result is hydrolysis. For the large group I intron ribozymes, the attacking nucleophile is the 3'-hydroxyl of the terminal ribose of another segment of RNA and the result is a splicing reaction.

The Ribosome—The Ultimate Ribozyme

The ribosome was the first example of a “molecular machine” to be recognized. A massive complex comprised of scores of protein subunits and several large ribosomal RNA molecules, the ribosome performs the vitally important and highly complex process of synthesizing long polypeptide chains following the instructions encoded in messenger RNA molecules (see Chapter 37). For many years, it was assumed that ribosomal RNAs played a passive, structural role, or perhaps assisted in the recognition of cognate mRNAs through a base

pairing mechanism. It was thus somewhat surprising when it was discovered that ribosomal RNAs were both necessary and sufficient for catalysis.

The RNA World Hypothesis

The discovery of ribozymes had a profound influence on evolutionary theory. For many years, scientists had hypothesized that the first biologic catalysts were formed when amino acids contained in the primordial soup coalesced to form simple proteins. With the realization that RNA could both carry information and catalyze simple chemical reactions, a new “RNA World” hypothesis emerged in which RNA constituted the first biological macromolecule. Eventually, DNA emerged as a more chemically stable oligonucleotide for long-term information storage while proteins, by virtue of their much greater variety of chemical functional groups, dominated catalysis. If one assumes that some sort of RNA-protein hybrid was formed as an intermediate in the transition from ribonucleotide to polypeptide catalysts, one need look no further than the ribosome to find the presumed missing link.

Why did not proteins take over all catalytic functions? Presumably, in the case of the ribosome the process was both too complex and too essential to permit much opportunity for possible competitors to gain a foothold. In the case of the small self-cleaving RNAs and self-splicing introns, they may represent one of the few cases in which RNA autocatalysis is more efficient than development of a new protein catalyst.

SUMMARY

- Enzymes are efficient catalysts whose stringent specificity extends to the kind of reaction catalyzed, and typically to a single substrate.
- Organic and inorganic prosthetic groups, cofactors, and coenzymes play important roles in catalysis. Coenzymes, many of which are derivatives of B vitamins, serve as “shuttles” for commonly used groups such as amines, electrons, and acetyl groups.
- During catalysis, enzymes frequently redirect the conformational changes induced by substrate binding to effect complementary changes in the substrate that facilitate its transformation into product.
- Catalytic mechanisms employed by enzymes include the introduction of strain, approximation of reactants, acid-base catalysis, and covalent catalysis. HIV protease illustrates acid-base catalysis; chymotrypsin and fructose-2,6-bisphosphatase illustrate covalent catalysis.
- Aminoacyl residues that participate in catalysis are highly conserved among all classes of a given enzyme. Site-directed mutagenesis, used to change residues suspected of being important in catalysis or substrate binding, provides insights into mechanisms of enzyme action.
- The catalytic activity of enzymes reveals their presence, facilitates their detection, and provides the basis for enzyme-linked immunoassays. Many enzymes can be assayed spectrophotometrically by coupling them to an NAD(P)⁺-dependent dehydrogenase.

- Combinatorial chemistry generates extensive libraries of potential enzyme activators and inhibitors that can be tested by high-throughput screening.
- Assay of plasma enzymes aids diagnosis and prognosis of myocardial infarction, acute pancreatitis, and various bone and liver disorders.
- Restriction endonucleases facilitate diagnosis of genetic diseases by revealing restriction fragment length polymorphisms, and the polymerase chain reaction (PCR) amplifies DNA initially present in quantities too small for analysis.
- Attachment of a polyhistidyl, glutathione S-transferase (GST), or other “tag” to the N- or C-terminus of a recombinant protein facilitates its purification by affinity chromatography on a solid support that contains an immobilized ligand such as a divalent cation (eg, Ni²⁺) or GST. Specific proteases can then remove affinity “tags” and generate the native enzyme.
- Not all enzymes are proteins. Several ribozymes are known that can cut and re-splice the phosphodiester bonds of RNA. In the ribosome, it is the rRNA and not the polypeptide components that are primarily responsible for catalysis.

REFERENCES

- Brik A, Wong C-H: HIV-1 protease: mechanism and drug discovery. *Org Biomol Chem* 2003;1:5.
- Burtis CA, Ashwood ER, Bruns DE: *Tietz Textbook of Clinical Chemistry and Molecular Diagnostics*. 4th ed. Elsevier, 2006.
- Cornish PV, Ha T: A survey of single-molecule techniques in chemical biology. *ACS Chem Biol* 2007;2:53.
- Doudna JA, Lorsch JR: Ribozyme catalysis: not different, just worse. *Nature Struct Biol* 2005;12:395.
- Frey PA, Hegeman AD: *Enzyme Reaction Mechanisms*. Oxford University Press, 2006.
- Geysen HM, Schoenen F, Wagner D, et al: Combinatorial compound libraries for drug discovery: an ongoing challenge. *Nature Rev Drug Disc* 2003;2:222.
- Goddard J-P, Reymond J-L: Enzyme assays for high-throughput screening. *Curr Opin Biotech* 2004;15:314.
- Gupta S, de Lemos JA: Use and misuse of cardiac troponins in clinical practice. *Prog Cardiovasc Dis* 2007;50:151.
- Hedstrom L: Serine protease mechanism and specificity. *Chem Rev* 2002;102:4501.
- Knight AE: Single enzyme studies: A historical perspective. *Meth Mol Biol* 2011;778:1.
- Knudsen BR, Jepsen ML, Ho YP: Quantum dot-based biomarkers for diagnosis via enzyme activity measurement. *Expert Rev Mol Diagn* 2013;13:367.
- Melanson SF, Tanasijevic MJ: Laboratory diagnosis of acute myocardial injury. *Cardiovascular Pathol* 2005;14:156.
- Parenti G, Pignata C, Vajro P, et al: New strategies for the treatment of lysosomal storage diseases (Review). *Int J Mol Med* 2013;31:11.
- Pereira DA, Williams JA: Origin and evolution of high throughput screening. *Br J Pharmacol* 2007;152:53.
- René AWF, Titman CM, Pratap CV, et al: A molecular switch and proton wire synchronize the active sites in thiamine enzymes. *Science* 2004;306:872.
- Schmeing TM, Ramakrishnan V: What recent ribosome structures have revealed about the mechanism of translation. *Nature* 2009;461:1234.
- Silverman RB: *The Organic Chemistry of Enzyme-Catalyzed Reactions*. Academic Press, 2002.
- Steussy CN, Critchelow CJ, Schmidt T, et al: A novel role for coenzyme A during hydride transfer in 3-hydroxy-3-methylglutaryl-coenzyme A reductase. *Biochemistry* 2013;52:5195.
- Sundaresan V, Abrol R: Towards a general model for protein-substrate stereoselectivity. *Protein Sci* 2002;11:1330.
- Todd AE, Orenge CA, Thornton JM: Plasticity of enzyme active sites. *Trends Biochem Sci* 2002;27:419.
- Walsh CT: *Enzymatic Reaction Mechanisms*. Freeman, 1979.

Enzymes: Kinetics

Peter J. Kennelly, PhD & Victor W. Rodwell, PhD

OBJECTIVES

After studying this chapter, you should be able to:

- Describe the scope and objectives of enzyme kinetic analysis.
- Indicate whether ΔG , the overall change in free energy for a reaction, is dependent on reaction mechanism.
- Indicate whether ΔG is a function of the *rates* of reactions.
- Explain the relationship between K_{eq} , concentrations of substrates and products at equilibrium, and the ratio of the rate constants k_1/k_{-1} .
- Outline how the concentration of hydrogen ions, of enzyme, and of substrate affect the rate of an enzyme-catalyzed reaction.
- Utilize collision theory to explain how temperature affects the rate of a chemical reaction.
- Define initial rate conditions and explain the advantage obtained from measuring the velocity of an enzyme-catalyzed reaction under these conditions.
- Describe the application of linear forms of the Michaelis-Menten equation to estimate K_m and V_{max} .
- Give one reason why a linear form of the Hill equation is used to evaluate how substrate-binding influences the kinetic behavior of certain multimeric enzymes.
- Contrast the effects of an increasing concentration of substrate on the kinetics of simple competitive and noncompetitive inhibition.
- Describe how substrates add to, and products depart from, an enzyme that follows a ping-pong mechanism.
- Describe how substrates add to, and products depart from, an enzyme that follows a rapid-equilibrium mechanism.
- Provide examples of the utility of enzyme kinetics in ascertaining the mode of action of drugs.

BIOMEDICAL IMPORTANCE

A complete and balanced set of enzyme activities is required for maintaining homeostasis. Enzyme kinetics, the quantitative measurement of the rates of enzyme-catalyzed reactions and the systematic study of factors that affect these rates, constitutes a central tool for the analysis, diagnosis, and treatment of the enzymic imbalances that underlie numerous human diseases. For example, kinetic analysis can reveal the number and order of the individual steps by which enzymes transform

substrates into products, and in conjunction with site-directed mutagenesis, kinetic analyses can reveal details of the catalytic mechanism of a given enzyme. In the blood, the appearance or a surge in the levels of particular enzymes serve as clinical indicators for pathologies such as myocardial infarctions, prostate cancer, and damage to the liver. The involvement of enzymes in virtually all physiologic processes makes them the targets of choice for drugs that cure or ameliorate human disease. Applied enzyme kinetics represents the principal tool by

which scientists identify and characterize therapeutic agents that selectively inhibit the rates of specific enzyme-catalyzed processes. Enzyme kinetics thus plays a central and critical role in drug discovery, in comparative pharmacodynamics, and in elucidating the mode of action of drugs.

CHEMICAL REACTIONS ARE DESCRIBED USING BALANCED EQUATIONS

A **balanced chemical equation** lists the initial chemical species (substrates) present and the new chemical species (products) formed for a particular chemical reaction, all in their respective proportions or **stoichiometry**. For example, balanced equation (1) indicates that one molecule each of substrates A and B react to form one molecule each of products P and Q:



The double arrows indicate reversibility, an intrinsic property of all chemical reactions. Thus, for reaction (1), if A and B can form P and Q, then P and Q can also form A and B. Designation of a particular reactant as a “substrate” or “product” is therefore somewhat arbitrary since the products for a reaction written in one direction are the substrates for the reverse reaction. The term “products” is, however, often used to designate the reactants whose formation is thermodynamically favored. Reactions for which thermodynamic factors strongly favor formation of the products to which the arrow points often are represented with a single arrow as if they were “irreversible”:



Unidirectional arrows are also used to describe reactions in living cells where the products of reaction (2) are immediately consumed by a subsequent enzyme-catalyzed reaction or rapidly escape the cell, for example, CO_2 . The rapid removal of product P or Q therefore effectively precludes occurrence of the reverse reaction, rendering equation (2) **functionally irreversible under physiological conditions**.

CHANGES IN FREE ENERGY DETERMINE THE DIRECTION & EQUILIBRIUM STATE OF CHEMICAL REACTIONS

The Gibbs free energy change ΔG (also called either free energy or Gibbs energy) describes in quantitative form both the *direction* in which a chemical reaction will tend to proceed and the concentrations of reactants and products that will be present at equilibrium. ΔG for a chemical reaction equals the sum of the free energies of formation of the reaction products ΔG_p minus the sum of the free energies of formation of the substrates ΔG_s . A similar but different quantity designated by ΔG^0 denotes the

change in free energy that accompanies transition from the standard state, one-molar concentrations of substrates and products, to equilibrium. A more useful biochemical term is ΔG^0 , which defines ΔG^0 at a standard state of 10^{-7} M protons, pH 7.0. If the free energy of formation of the products is *lower* than that of the substrates, the signs of ΔG^0 and ΔG^0 will be *negative*, indicating that the reaction as written is favored in the direction left to right. Such reactions are referred to as **spontaneous**. The **sign** and the **magnitude** of the free energy change determine how far the reaction will proceed.

Equation (3) illustrates the relationship between the equilibrium constant K_{eq} and ΔG^0 :

$$\Delta G^0 = -RT \ln K_{\text{eq}} \quad (3)$$

where R is the gas constant (1.98 cal/mol $^\circ\text{K}$ or 8.31 J/mol $^\circ\text{K}$) and T is the absolute temperature in degrees Kelvin. K_{eq} is equal to the product of the concentrations of the reaction products, each raised to the power of their stoichiometry, divided by the product of the substrates, each raised to the power of their stoichiometry:

For the reaction $A + B \rightleftharpoons P + Q$

$$K_{\text{eq}} = \frac{[P][Q]}{[A][B]} \quad (4)$$

and for reaction (5)



$$K_{\text{eq}} = \frac{[P]}{[A]^2} \quad (6)$$

ΔG^0 may be calculated from equation (3) if the molar concentrations of substrates and products present at equilibrium are known. If ΔG^0 is a negative number, K_{eq} will be greater than unity, and the concentration of products at equilibrium will exceed that of the substrates. If ΔG^0 is positive, K_{eq} will be less than unity, and the formation of substrates will be favored.

Note that, since ΔG^0 is a function exclusively of the initial and final states of the reacting species, it can provide information only about the *direction* and *equilibrium state* of the reaction. ΔG^0 is independent of the **mechanism** of the reaction, and provides no information concerning **rates** of reactions. Consequently—and as explained below—although a reaction may have a large negative ΔG^0 or ΔG^0 , it may nevertheless take place at a negligible rate.

THE RATES OF REACTIONS ARE DETERMINED BY THEIR ACTIVATION ENERGY

Reactions Proceed via Transition States

The concept of the **transition state** is fundamental to understanding the chemical and thermodynamic basis of catalysis. Equation (7) depicts a group transfer reaction in which an

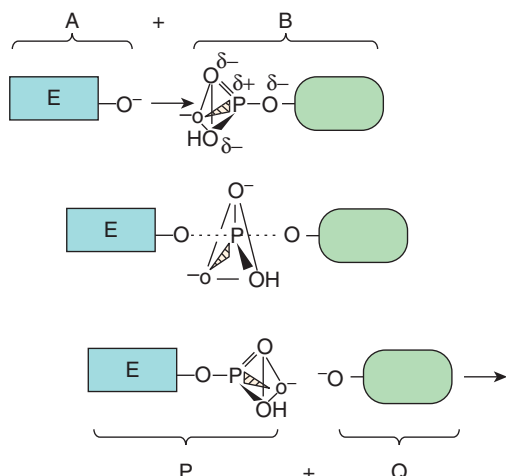
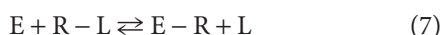

FIGURE 8-1 Formation of a transition state intermediate during a simple chemical reaction, $A + B \rightarrow P + Q$. Shown are three stages of a chemical reaction in which a phosphoryl group is transferred from leaving group L (green) to entering group E (blue). **Top:** entering group E (A) approaches the other reactant, L-phosphate (B). Notice how the three oxygen atoms linked by the triangular lines and the phosphorus atom of the phosphoryl group form a pyramid. **Center:** as E approaches L-phosphate, the new bond between E and the phosphoryl group begins to form (dotted line) as that linking L to the phosphoryl group weakens. These partially formed bonds are indicated by dotted lines. **Bottom:** formation of the new product, E-phosphate (P), is now complete as the leaving group L (Q) exits. Notice how the geometry of the phosphoryl group differs between the transition state and the substrate or product. Notice how the phosphorus and three oxygen atoms that occupy the four corners of a pyramid in the substrate and product become coplanar, as emphasized by the triangle, in the transition state.

entering group E displaces a leaving group L, attached initially to R:



The net result of this process is to transfer group R from L to E. Midway through the displacement, the bond between R and L has weakened but has not yet been completely severed, and the new bond between E and R is yet incompletely formed. This transient intermediate—in which neither free substrate nor product exists—is termed the **transition state**, $E \cdots R \cdots L$. Dotted lines represent the “partial” bonds that are undergoing formation and rupture. **Figure 8-1** provides a more detailed illustration of the transition state intermediate formed during the transfer of a phosphoryl group.

Reaction (7) can be thought of as consisting of two “partial reactions,” the first corresponding to the formation (F) and the second to the subsequent decay (D) of the transition state intermediate. As for all reactions, characteristic changes in free energy, ΔG_F and ΔG_D are associated with each partial reaction:

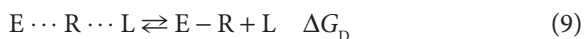

For the overall reaction (10), ΔG is the numeric sum of ΔG_F and ΔG_D . As for any equation of two terms, it is not possible to deduce from their resultant ΔG either the sign or the magnitude of ΔG_F or ΔG_D .

Many reactions involve several successive transition states, each with an associated change in free energy. For these reactions, the overall ΔG represents the sum of *all* of the free energy changes associated with the formation and decay of *all* of the transition states. **It therefore is not possible to infer from the overall ΔG the number or type of transition states through which the reaction proceeds.** Stated another way, *overall reaction thermodynamics tells us nothing about mechanism or kinetics.*

ΔG_F Defines the Activation Energy

Regardless of the sign or magnitude of ΔG , ΔG_F for the overwhelming majority of chemical reactions has a positive sign, which indicates that formation of the transition state requires surmounting one or more energy barriers. For this reason, ΔG_F for reaching a transition state is often termed the **activation energy**, E_{act} . The ease—and hence the frequency—with which this barrier is overcome is *inversely* related to E_{act} . The thermodynamic parameters that determine how *fast* a reaction proceeds thus are the ΔG_F values for formation of the transition states through which the reaction proceeds. For a simple reaction, where \propto means “proportionate to,”

$$\text{Rate} \propto e^{-E_{act}/RT} \quad (11)$$

The activation energy for the reaction proceeding in the opposite direction to that drawn is equal to $-\Delta G_D$.

NUMEROUS FACTORS AFFECT REACTION RATE

The **kinetic theory**—also called the **collision theory**—of chemical kinetics states that for two molecules to react they (1) must approach within bond-forming distance of one another, or “collide,” and (2) must possess sufficient kinetic energy to overcome the energy barrier for reaching the transition state. It therefore follows that conditions that tend to increase the *frequency* or *energy* of collision between substrates will tend to increase the rate of the reaction in which they participate.

Temperature

Raising the ambient temperature increases the kinetic energy of molecules. As illustrated in **Figure 8-2**, the total number of molecules whose kinetic energy exceeds the energy barrier E_{act} (vertical bar) for formation of products increases from low (A) through intermediate (B) to high (C) temperatures. Increasing the kinetic energy of molecules also increases their rapidity of motion, and therefore the frequency with which they collide. This combination of more frequent and more highly energetic, and hence productive, collisions increases the reaction rate.

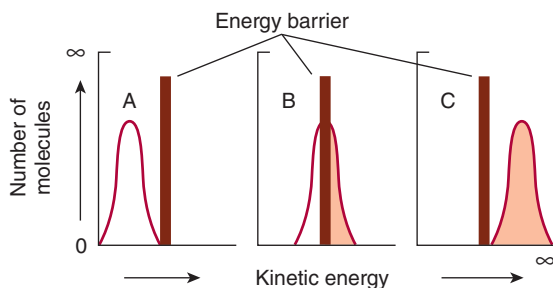
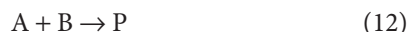

FIGURE 8-2 The energy barrier for chemical reactions. (See text for discussion.)

Reactant Concentration

The frequency with which molecules collide is directly proportionate to their concentrations. For two different molecules A and B, the frequency with which they collide will double if the concentration of either A or B is doubled. If the concentrations of both A and B are doubled, the probability of collision will increase fourfold.

For a chemical reaction proceeding at constant temperature that involves one molecule each of A and B,



the fraction of the molecules possessing a given kinetic energy will be a constant. The number of collisions between molecules whose combined kinetic energy is sufficient to produce product P therefore will be directly proportionate to the number of collisions between A and B, and thus to their molar concentrations, denoted by the square brackets:

$$\text{Rate} \propto [A][B] \quad (13)$$

Similarly, for the reaction represented by



which can also be written as



The corresponding rate expression is

$$\text{Rate} \propto [A][B][B] \quad (16)$$

or

$$\text{Rate} \propto [A][B]^2 \quad (17)$$

For the general case, when n molecules of A react with m molecules of B,



the rate expression is

$$\text{Rate} \propto [A]^n[B]^m \quad (19)$$

Replacing the proportionality sign with an equals sign by introducing a **rate constant**, k , characteristic of the reaction under

study gives equations (20) and (21), in which the subscripts 1 and -1 refer to the forward and reverse reactions, respectively:

$$\text{Rate}_1 = k_1[A]^n[B]^m \quad (20)$$

$$\text{Rate}_{-1} = k_{-1}[P] \quad (21)$$

The sum of the molar ratios of the reactants defines the **kinetic order** of the reaction. Consider reaction (5). The stoichiometric coefficient for the sole reactant, A, is 2. Therefore, the rate of production of P is proportional to the square of [A] and the reaction is said to be *second order* with respect to reactant A. In this instance, the overall reaction is also *second order*. Therefore, k_1 is referred to as a *second-order rate constant*.

Reaction (12) describes a simple second-order reaction between two different reactants, A and B. The stoichiometric coefficient for each reactant is 1. Therefore, while the reaction is second order it is said to be *first order* with respect to A and *first order* with respect to B.

In the laboratory, the kinetic order of a reaction with respect to a particular reactant, referred to as the variable reactant or substrate, can be determined by maintaining the concentration of the other reactants in large excess over the variable reactant. Under these *pseudo-first-order conditions*, the concentration of the “fixed” reactant remains virtually constant. Thus, the rate of reaction will depend exclusively on the concentration of the variable reactant, sometimes also called the limiting reactant. The concepts of reaction order and pseudo-first-order conditions apply not only to simple chemical reactions but also to enzyme-catalyzed reactions.

K_{eq} Is a Ratio of Rate Constants

While all chemical reactions are to some extent reversible, at equilibrium the *overall* concentrations of reactants and products remain constant. At equilibrium, the rate of conversion of substrates to products therefore equals the rate at which products are converted to substrates:

$$\text{Rate}_1 = \text{Rate}_{-1} \quad (22)$$

Therefore,

$$k_1[A]^n[B]^m = k_{-1}[P] \quad (23)$$

and

$$\frac{k_1}{k_{-1}} = \frac{[P]}{[A]^n[B]^m} \quad (24)$$

The ratio of k_1 to k_{-1} is equal to the equilibrium constant, K_{eq} . The following important properties of a system at equilibrium must be kept in mind.

1. The equilibrium constant is a ratio of the reaction rate *constants* (not the reaction *rates*).
2. At equilibrium, the reaction *rates* (not the *rate constants*) of the forward and back reactions are equal.

- The numeric value of the equilibrium constant K_{eq} can be calculated either from the concentrations of substrates and products at equilibrium or from the ratio k_1/k_{-1} .
- Equilibrium is a *dynamic* state. Although there is no *net* change in the concentration of substrates or products, individual substrate and product molecules are continually being interconverted. Interconvertibility can be proved by adding to a system at equilibrium a trace of radioisotopic product, which can then be shown to result in the appearance of radiolabelled substrate.

THE KINETICS OF ENZYME CATALYSIS

Enzymes Lower the Activation Energy Barrier for a Reaction

All enzymes accelerate reaction rates by lowering ΔG_{F} for the formation of transition states. However, they may differ in the way this is achieved. While the sequence of chemical steps at the active site parallels those which occur when the substrates react in the absence of a catalyst, **the environment of the active site lowers ΔG_{F}** by stabilizing the transition state intermediates. To put it another way, the enzyme can be envisioned as binding to the transition state intermediate (Figure 8-1) more tightly than it does to either substrates or products. As discussed in Chapter 7, stabilization can involve (1) acid-base groups suitably positioned to transfer protons to or from the developing transition state intermediate, (2) suitably positioned charged groups or metal ions that stabilize developing charges, or (3) the imposition of steric strain on substrates so that their geometry approaches that of the transition state. HIV protease (see Figure 7-6) illustrates catalysis by an enzyme that lowers the activation barrier in part by stabilizing a transition state intermediate.

Catalysis by enzymes that proceeds via a *unique* reaction mechanism typically occurs when the transition state intermediate forms a covalent bond with the enzyme (**covalent catalysis**). The catalytic mechanism of the serine protease chymotrypsin (see Figure 7-7) illustrates how an enzyme utilizes covalent catalysis to provide a unique reaction pathway possessing a more favorable E_{act} .

ENZYMES DO NOT AFFECT K_{eq}

While enzymes undergo transient modifications during the process of catalysis, they always emerge unchanged at the completion of the reaction. **The presence of an enzyme therefore has no effect on ΔG^0 for the overall reaction**, which is a function solely of the **initial and final states** of the reactants. Equation (25) shows the relationship between the equilibrium constant for a reaction and the standard free energy change for that reaction:

$$\Delta G^0 = -RT \ln K_{\text{eq}} \quad (25)$$

This principle is perhaps most readily illustrated by including the presence of the enzyme (Enz) in the calculation of the equilibrium constant for an enzyme-catalyzed reaction:

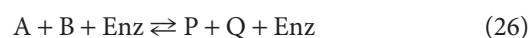

Since the enzyme on both sides of the double arrows is present in equal quantity and identical form, the expression for the equilibrium constant,

$$K_{\text{eq}} = \frac{[P][Q][\text{Enz}]}{[A][B][\text{Enz}]} \quad (27)$$

reduces to one identical to that for the reaction in the *absence* of the enzyme:

$$K_{\text{eq}} = \frac{[P][Q]}{[A][B]} \quad (28)$$

Enzymes therefore have no effect on K_{eq} .

MULTIPLE FACTORS AFFECT THE RATES OF ENZYME-CATALYZED REACTIONS

Temperature

Raising the temperature increases the rate of both uncatalyzed and enzyme-catalyzed reactions by increasing the kinetic energy and the collision frequency of the reacting molecules. However, heat energy can also increase the conformational flexing of the enzyme to a point that exceeds the energy barrier for disrupting the noncovalent interactions that maintain its three-dimensional structure. The polypeptide chain then begins to unfold, or **denature**, with an accompanying loss of the catalytic activity. The temperature range over which an enzyme maintains a stable, catalytically competent conformation depends upon—and typically moderately exceeds—the normal temperature of the cells in which it resides. Enzymes from humans generally exhibit stability at temperatures up to 45 to 55°C. By contrast, enzymes from the thermophilic microorganisms that reside in volcanic hot springs or under-sea hydrothermal vents may be stable at temperatures up to or even above 100°C.

The **temperature coefficient (Q_{10})** is the factor by which the rate of a biologic process increases for a 10°C increase in temperature. For the temperatures over which enzymes are stable, the rates of most biological processes typically double for a 10°C rise in temperature ($Q_{10} = 2$). Changes in the rates of enzyme-catalyzed reactions that accompany a rise or fall in body temperature constitute a prominent survival feature for “cold-blooded” life forms such as lizards or fish, whose body temperatures are dictated by the external environment. However, for mammals and other homeothermic organisms,

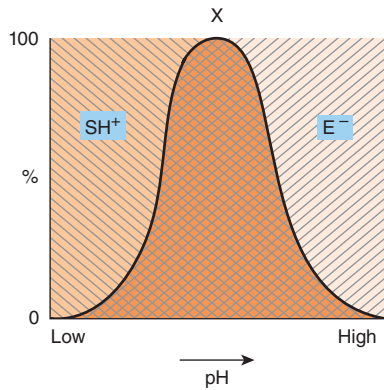

FIGURE 8-3 Effect of pH on enzyme activity. Consider, for example, a negatively charged enzyme (E^-) that binds a positively charged substrate (SH^+). Shown is the proportion (%) of SH^+ [\\] and of E^- [///] as a function of pH. Only in the cross-hatched area do both the enzyme and the substrate bear an appropriate charge.

changes in enzyme reaction rates with temperature assume physiologic importance only in circumstances such as fever or hypothermia.

Hydrogen Ion Concentration

The rate of almost all enzyme-catalyzed reactions exhibits a significant dependence on hydrogen ion concentration. Most intracellular enzymes exhibit optimal activity at pH values between 5 and 9. The relationship of activity to hydrogen ion concentration (**Figure 8-3**) reflects the balance between enzyme denaturation at high or low pH and effects on the charged state of the enzyme, the substrates, or both. For enzymes whose mechanism involves acid-base catalysis, the residues involved must be in the appropriate state of protonation for the reaction to proceed. The binding and recognition of substrate molecules with dissociable groups also typically involves the formation of salt bridges with the enzyme. The most common charged groups are carboxylate groups (negative) and protonated amines (positive). Gain or loss of critical charged groups adversely affects substrate binding and thus will retard or abolish catalysis.

ASSAYS OF ENZYME-CATALYZED REACTIONS TYPICALLY MEASURE THE INITIAL VELOCITY

Most measurements of the rates of enzyme-catalyzed reactions employ relatively short time periods, conditions that are considered to approximate **initial rate conditions**. Under these conditions, only traces of product accumulate, rendering the rate of the reverse reaction negligible. The **initial velocity** (v_i) of the reaction thus is essentially that of the rate of the forward reaction. Assays of enzyme activity almost always employ a large (10^3 - 10^6) molar excess of substrate over enzyme.

Under these conditions, v_i is proportionate to the concentration of enzyme, that is, it is pseudo first order with respect to enzyme. Measuring the initial velocity therefore permits one to estimate the quantity of enzyme present in a biologic sample.

SUBSTRATE CONCENTRATION AFFECTS THE REACTION RATE

In what follows, enzyme reactions are treated as if they had only a single substrate and a single product. For enzymes with multiple substrates, the principles discussed below apply with equal validity. Moreover, by employing pseudo first-order conditions (see above), scientists can study the dependence of reaction rate upon an individual reactant through the appropriate choice of fixed and variable substrates. In other words, under pseudo first-order conditions the behavior of a multi-substrate enzyme will imitate one having a single substrate. In this instance, however, the observed rate constant will be a function both of the rate constant k_1 for the reaction and of the concentration of the fixed substrate.

For a typical enzyme, as substrate concentration is increased, v_i increases until it reaches a maximum value V_{max} (**Figure 8-4**). When further increases in substrate concentration fail to increase v_i , the enzyme is said to be “saturated” with the substrate. Note that the shape of the curve that relates activity to substrate concentration (**Figure 8-4**) is *hyperbolic*. At any given instant, only substrate molecules that are combined with the enzyme as an enzyme-substrate (ES) complex can be transformed into a product. Since the equilibrium constant for the formation of the enzyme-substrate complex is not infinitely large, only a fraction of the enzyme may be present as an ES complex even when the substrate is present in considerable excess (points A and B of **Figure 8-5**). At points A or B, increasing or decreasing $[S]$ therefore will increase or decrease the number of ES complexes with a corresponding change in v_i . At point C (**Figure 8-5**), however, essentially all the enzyme is present as the ES complex. Since no free enzyme remains available for forming ES, further increases in $[S]$ cannot increase the rate of the reaction. **Under these saturating conditions, v_i depends solely on—and thus is limited by—the rapidity with which product dissociates from the enzyme so that it may combine with more substrate.**

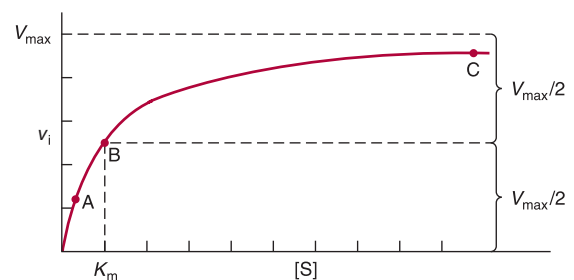

FIGURE 8-4 Effect of substrate concentration on the initial velocity of an enzyme-catalyzed reaction.

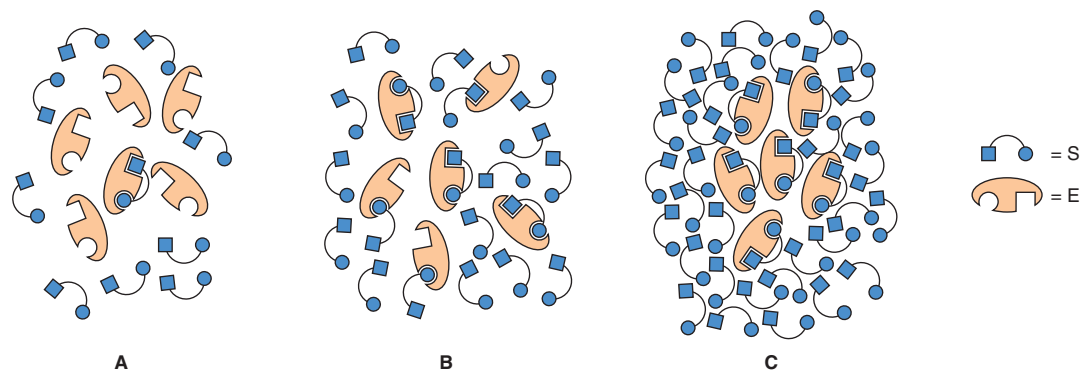

FIGURE 8-5 Representation of an enzyme in the presence of a concentration of substrate that is below K_m (A), at a concentration equal to K_m (B), and at a concentration well above K_m (C). Points A, B, and C correspond to those points in Figure 8-4.

THE MICHAELIS-MENTEN & HILL EQUATIONS MODEL THE EFFECTS OF SUBSTRATE CONCENTRATION

The Michaelis-Menten Equation

The Michaelis-Menten equation (29) illustrates in mathematical terms the relationship between initial reaction velocity v_i and substrate concentration $[S]$, shown graphically in Figure 8-4:

$$v_i = \frac{V_{\max}[S]}{K_m + [S]} \quad (29)$$

The Michaelis constant K_m is the substrate concentration at which v_i is half the maximal velocity ($V_{\max}/2$) attainable at a particular concentration of the enzyme. K_m thus has the dimensions of substrate concentration. The dependence of initial reaction velocity on $[S]$ and K_m may be illustrated by evaluating the Michaelis-Menten equation under three conditions.

1. When $[S]$ is much less than K_m (point A in Figures 8-4 and 8-5), the term $K_m + [S]$ is essentially equal to K_m . Replacing $K_m + [S]$ with K_m reduces equation (29) to

$$v_i = \frac{V_{\max}[S]}{K_m + [S]} \quad v_i \approx \frac{V_{\max}[S]}{K_m} \approx \left(\frac{V_{\max}}{K_m}\right)[S] \quad (30)$$

where \approx means “approximately equal to.” Since V_{\max} and K_m are both constants, their ratio is a constant. In other words, when $[S]$ is considerably below K_m , v_i is proportionate to $k[S]$. The initial reaction velocity therefore is directly proportional to $[S]$.

2. When $[S]$ is much greater than K_m (point C in Figures 8-4 and 8-5), the term $K_m + [S]$ is essentially equal to $[S]$. Replacing $K_m + [S]$ with $[S]$ reduces equation (29) to

$$v_i = \frac{V_{\max}[S]}{K_m + [S]} \quad v_i \approx \frac{V_{\max}[S]}{[S]} \approx V_{\max} \quad (31)$$

Thus, when $[S]$ greatly exceeds K_m , the reaction velocity is maximal (V_{\max}) and unaffected by further increases in the substrate concentration.

3. When $[S] = K_m$ (point B in Figures 8-4 and 8-5):

$$v_i = \frac{V_{\max}[S]}{K_m + [S]} = \frac{V_{\max}[S]}{2[S]} = \frac{V_{\max}}{2} \quad (32)$$

Equation (32) states that when $[S]$ equals K_m , the initial velocity is half-maximal. Equation (32) also reveals that K_m is—and may be determined experimentally from—the substrate concentration at which the initial velocity is half-maximal.

A Linear Form of the Michaelis-Menten Equation Is Used to Determine K_m & V_{\max}

The direct measurement of the numeric value of V_{\max} , and therefore the calculation of K_m , often requires impractically high concentrations of substrate to achieve saturating conditions. A linear form of the Michaelis-Menten equation circumvents this difficulty and permits V_{\max} and K_m to be extrapolated from initial velocity data obtained at less than saturating concentrations of the substrate. Start with equation (29),

$$v_i = \frac{V_{\max}[S]}{K_m + [S]} \quad (29)$$

invert

$$\frac{1}{v_i} = \frac{K_m + [S]}{V_{\max}[S]} \quad (33)$$

factor

$$\frac{1}{v_i} = \frac{K_m}{V_{\max}[S]} + \frac{[S]}{V_{\max}[S]} \quad (34)$$

and simplify

$$\frac{1}{v_i} = \left(\frac{K_m}{V_{\max}}\right)\frac{1}{[S]} + \frac{1}{V_{\max}} \quad (35)$$

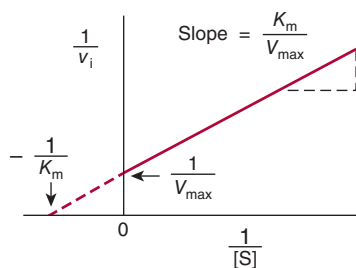

FIGURE 8-6 Double-reciprocal or Lineweaver-Burk plot of $1/v_i$ versus $1/[S]$ used to evaluate K_m and V_{\max} .

Equation (35) is the equation for a straight line, $y = ax + b$, where $y = 1/v_i$ and $x = 1/[S]$. A plot of $1/v_i$ as y as a function of $1/[S]$ as x therefore gives a straight line whose y intercept is $1/V_{\max}$ and whose slope is K_m/V_{\max} . Such a plot is called a **double reciprocal** or **Lineweaver-Burk plot** (Figure 8-6). Setting the y term of equation (36) equal to zero and solving for x reveals that the x intercept is $-1/K_m$:

$$0 = ax + b; \text{ therefore, } x = \frac{-b}{a} = \frac{-1}{K_m} \quad (36)$$

K_m can be calculated from the slope and y intercept, but is perhaps most readily calculated from the negative x intercept.

The greatest virtue of the Lineweaver-Burk plot resides in the facility with which it can be used to determine the kinetic mechanism of an enzyme inhibitor (see below). However, in using a double-reciprocal plot to determine kinetic constants it is important to avoid the introduction of bias through the clustering of data at low values of $1/[S]$. This bias can be readily avoided in the laboratory as follows. Prepare a solution of substrate whose dilution into an assay will produce the maximum desired concentration of the substrate. Now prepare dilutions of the stock solution by factors of 1:2, 1:3, 1:4, 1:5, etc. Data generated using equal volumes of these dilutions will then fall on the $1/[S]$ axis at equally spaced intervals of 1, 2, 3, 4, 5, etc. A single-reciprocal plot such as the Eadie-Hofstee (v_i vs $v_i/[S]$) or Hanes-Woolf ($[S]/v_i$ vs $[S]$) plot can also be used to minimize data clustering.

The Catalytic Constant, k_{cat}

Several parameters may be used to compare the relative activity of different enzymes or of different preparations of the same enzyme. The activity of impure enzyme preparations typically is expressed as a *specific activity* (V_{\max} divided by the protein concentration). For a homogeneous enzyme, one may calculate its *turnover number* (V_{\max} divided by the moles of enzyme present). But if the number of active sites present is known, the catalytic activity of a homogeneous enzyme is best expressed as its *catalytic constant*, k_{cat} (V_{\max} divided by the number of active sites, S_t):

$$k_{\text{cat}} = \frac{V_{\max}}{S_t} \quad (37)$$

Since the units of concentration cancel out, the units of k_{cat} are reciprocal time.

Catalytic Efficiency, k_{cat}/K_m

By what measure should the efficiency of different enzymes, different substrates for a given enzyme, and the efficiency with which an enzyme catalyzes a reaction in the forward and reverse directions be quantified and compared? While the maximum capacity of a given enzyme to convert substrate to product is important, the benefits of a high k_{cat} can only be realized if K_m is sufficiently low. Thus, *catalytic efficiency* of enzymes is best expressed in terms of the *ratio* of these two kinetic constants, k_{cat}/K_m .

For certain enzymes, once substrate binds to the active site, it is converted to product and released so rapidly as to render these events effectively instantaneous. For these exceptionally efficient catalysts, the rate-limiting step in catalysis is the formation of the ES complex. Such enzymes are said to be *diffusion-limited*, or catalytically perfect, since the fastest possible rate of catalysis is determined by the rate at which molecules move or diffuse through the solution. Examples of enzymes for which k_{cat}/K_m approaches the diffusion limit of 10^8 - $10^9 \text{ M}^{-1}\text{s}^{-1}$ include triosephosphate isomerase, carbonic anhydrase, acetylcholinesterase, and adenosine deaminase.

In living cells, the assembly of enzymes that catalyze successive reactions into multimeric complexes can circumvent the limitations imposed by diffusion. The geometric relationships of the enzymes in these complexes are such that the substrates and products do not diffuse into the bulk solution until the last step in the sequence of catalytic steps is complete. Fatty acid synthetase extends this concept one step further by covalently attaching the growing substrate fatty acid chain to a biotin tether that rotates from active site to active site within the complex until synthesis of a palmitic acid molecule is complete (see Chapter 23).

K_m May Approximate a Binding Constant

The affinity of an enzyme for its substrate is the inverse of the dissociation constant K_d for dissociation of the enzyme-substrate complex ES:



$$K_d = \frac{k_{-1}}{k_1} \quad (39)$$

Stated another way, the *smaller* the tendency of the enzyme and its substrate to *dissociate*, the *greater* the affinity of the enzyme for its substrate. While the Michaelis constant K_m often approximates the dissociation constant K_d , this should not be assumed, for it is by no means always the case. For a typical enzyme-catalyzed reaction:

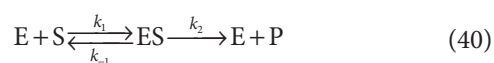

The value of $[S]$ that gives $v_i = V_{\max}/2$ is

$$[S] = \frac{k_{-1} + k_2}{k_1} = K_m \quad (41)$$

When $k_{-1} \gg k_2$, then

$$k_{-1} + k_2 \approx k_{-1} \quad (42)$$

and

$$[S] \approx \frac{k_1}{k_{-1}} = K_d \quad (43)$$

Hence, $1/K_m$ only approximates $1/K_d$ under conditions where the association and dissociation of the ES complex are rapid relative to catalysis. For the many enzyme-catalyzed reactions for which $k_{-1} + k_2$ is **not** approximately equal to k_{-1} , $1/K_m$ will underestimate $1/K_d$.

The Hill Equation Describes the Behavior of Enzymes That Exhibit Cooperative Binding of Substrate

While most enzymes display the simple **saturation kinetics** depicted in Figure 8-4 and are adequately described by the Michaelis-Menten expression, some enzymes bind their substrates in a **cooperative** fashion analogous to the binding of oxygen by hemoglobin (see Chapter 6). Cooperative behavior is an *exclusive* property of multimeric enzymes that bind substrate at multiple sites.

For enzymes that display positive cooperativity in binding the substrate, the shape of the curve that relates changes in v_i to changes in $[S]$ is sigmoidal (Figure 8-7). Neither the Michaelis-Menten expression nor its derived plots can be used to evaluate cooperative kinetics. Enzymologists therefore employ a graphic representation of the **Hill equation** originally derived to describe the cooperative binding of O_2 by hemoglobin. Equation (44) represents the Hill equation arranged in a form that predicts a straight line, where k' is a complex constant:

$$\frac{\log v_i}{V_{\max} - v_i} = n \log [S] - \log k' \quad (44)$$

Equation (44) states that when $[S]$ is low relative to k' , the initial reaction velocity increases as the n th power of $[S]$.

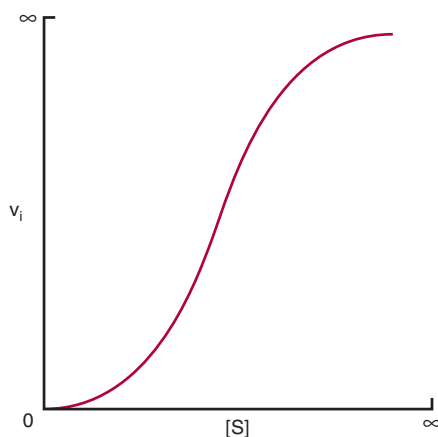

FIGURE 8-7 Representation of sigmoid substrate saturation kinetics.

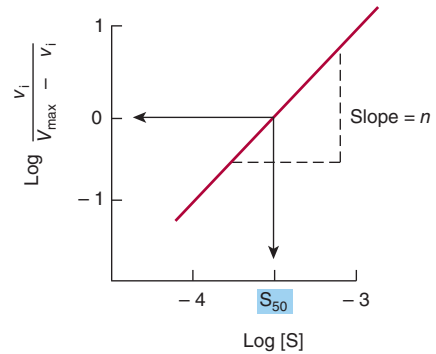

FIGURE 8-8 A graphical representation of a linear form of the Hill equation is used to evaluate S_{50} , the substrate concentration that produces half-maximal velocity, and the degree of cooperativity n .

A graph of $\log v_i / (V_{\max} - v_i)$ versus $\log [S]$ gives a straight line (Figure 8-8). The slope of the line, n , is the **Hill coefficient**, an empirical parameter whose value is a function of the number, kind, and strength of the interactions of the multiple substrate-binding sites on the enzyme. When $n = 1$, all binding sites behave independently and simple Michaelis-Menten kinetic behavior is observed. If n is greater than 1, the enzyme is said to exhibit **positive cooperativity**. Binding of substrate to one site then enhances the affinity of the remaining sites to bind additional substrate. The greater the value for n , the higher the degree of cooperativity and the more markedly sigmoidal will be the plot of v_i versus $[S]$. A perpendicular dropped from the point where the y term $\log v_i / (V_{\max} - v_i)$ is zero intersects the x -axis at a substrate concentration termed S_{50} , the substrate concentration that results in half-maximal velocity. S_{50} thus is analogous to the P_{50} for oxygen binding to hemoglobin (see Chapter 6).

KINETIC ANALYSIS DISTINGUISHES COMPETITIVE FROM NONCOMPETITIVE INHIBITION

Inhibitors of the catalytic activities of enzymes provide both pharmacologic agents and research tools for the study of the mechanism of enzyme action. The strength of the interaction between an inhibitor and an enzyme depends on forces important in protein structure and ligand binding (hydrogen bonds, electrostatic interactions, hydrophobic interactions, and van der Waals forces; see Chapter 5). Inhibitors can be classified on the basis of their site of action on the enzyme, on whether they chemically modify the enzyme, or on the kinetic parameters they influence. Compounds that mimic the transition state of an enzyme-catalyzed reaction (**transition state analogs**) or that take advantage of the catalytic machinery of an enzyme (**mechanism-based inhibitors**) can be particularly potent inhibitors. Kinetically, we distinguish two classes of inhibitors based upon whether raising the substrate concentration does or does not overcome the inhibition.

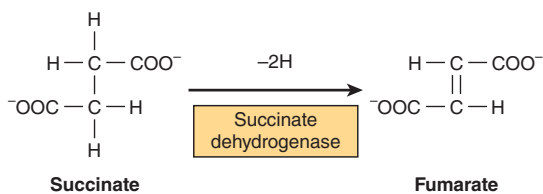

FIGURE 8-9 The succinate dehydrogenase reaction.

Competitive Inhibitors Typically Resemble Substrates

The effects of competitive inhibitors can be overcome by raising the concentration of substrate. Most frequently, in competitive inhibition the inhibitor (I) binds to the substrate-binding portion of the active site thereby blocking access by the substrate. The structures of most classic competitive inhibitors therefore tend to resemble the structure of a substrate, and thus are termed **substrate analogs**. Inhibition of the enzyme succinate dehydrogenase by malonate illustrates competitive inhibition by a substrate analog. Succinate dehydrogenase catalyzes the removal of one hydrogen atom from each of the two methylene carbons of succinate (Figure 8-9). Both succinate and its structural analog malonate ($^-\text{OOC}-\text{CH}_2-\text{COO}^-$) can bind to the active site of succinate dehydrogenase, forming an ES or an EI complex, respectively. However, since malonate contains only one methylene carbon, it cannot undergo dehydrogenation.

The formation and dissociation of the EI complex is a dynamic process described by



for which the equilibrium constant K_i is

$$K_i = \frac{[\text{E}][\text{I}]}{[\text{E} - \text{I}]} = \frac{k_1}{k_{-1}} \quad (46)$$

In effect, a **competitive inhibitor acts by decreasing the number of free enzyme molecules available to bind substrate, that is, to form ES, and thus eventually to form product**, as described below.

A competitive inhibitor and substrate exert reciprocal effects on the concentration of the EI and ES complexes. Since the formation of ES complexes removes free enzyme available to combine with the inhibitor, increasing [S] *decreases* the concentration of the EI complex and *raises* the reaction velocity. The extent to which [S] must be increased to completely overcome the inhibition depends upon the concentration of the inhibitor present, its affinity for the enzyme (K_i), and the affinity, K_m , of the enzyme for its substrate.

Double-Reciprocal Plots Facilitate the Evaluation of Inhibitors

Double-reciprocal plots typically are used both to distinguish between competitive and noncompetitive inhibitors and to simplify evaluation of inhibition constants. v_i is determined

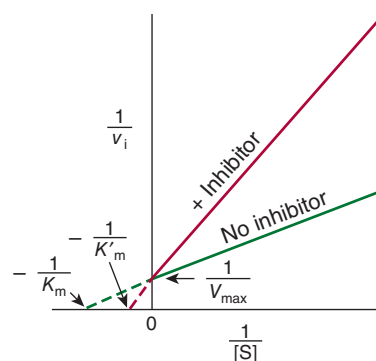

FIGURE 8-10 Lineweaver-Burk plot of simple competitive inhibition. Note the complete relief of inhibition at high [S] (ie, low $1/[S]$).

at several substrate concentrations both in the presence and in the absence of the inhibitor. For classic competitive inhibition, the lines that connect the experimental data points converge at the y -axis (Figure 8-10). Since the y intercept is equal to $1/V_{\max}$, this pattern indicates that **when $1/[S]$ approaches 0, v_i is independent of the presence of inhibitor**. Note, however, that the intercept on the x -axis *does* vary with inhibitor concentration and that, since $-1/K'_m$ is smaller than $-1/K_m$, K'_m (the “apparent K_m ”) becomes larger in the presence of increasing concentrations of the inhibitor. Thus, a **competitive inhibitor has no effect on V_{\max} but raises K'_m , the apparent K_m for the substrate**. For a simple competitive inhibition, the intercept on the x -axis is

$$x = \frac{-1}{K_m} \left(1 + \frac{[\text{I}]}{K_i} \right) \quad (47)$$

Once K_m has been determined in the absence of inhibitor, K_i can be calculated from equation (47). K_i values are used to compare different inhibitors of the same enzyme. The *lower* the value for K_i , the more effective the inhibitor. For example, the statin drugs that act as competitive inhibitors of HMG-CoA reductase (see Chapter 26) have K_i values several orders of magnitude lower than the K_m for the substrate, HMG-CoA.

Simple Noncompetitive Inhibitors Lower V_{\max} But Do Not Affect K_m

In strict noncompetitive inhibition, binding of the inhibitor does not affect binding of the substrate. Formation of both EI and EIS complexes is therefore possible. However, while the enzyme-inhibitor complex can still bind the substrate, its efficiency at transforming substrate to product, reflected by V_{\max} , is decreased. Noncompetitive inhibitors bind enzymes at sites distinct from the substrate-binding site and generally bear little or no structural resemblance to the substrate.

For simple noncompetitive inhibition, E and EI possess identical affinity for the substrate, and the EIS complex generates product at a negligible rate (Figure 8-11). More complex noncompetitive inhibition occurs when binding of the

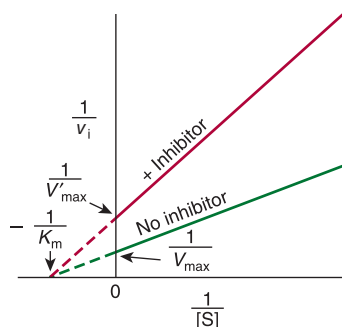

FIGURE 8-11 Lineweaver-Burk plot for simple noncompetitive inhibition.

inhibitor *does* affect the apparent affinity of the enzyme for the substrate, causing the lines to intersect in either the third or fourth quadrants of a double-reciprocal plot (not shown). While certain inhibitors exhibit characteristics of a mixture of competitive and noncompetitive inhibition, the evaluation of these inhibitors exceeds the scope of this chapter.

Dixon Plot

A Dixon plot is sometimes employed as an alternative to the Lineweaver-Burk plot for determining inhibition constants. The initial velocity (v_i) is measured at several concentrations of inhibitor, but at a fixed concentration of the substrate (S). For a simple competitive or noncompetitive inhibitor, a plot of $1/v_i$ versus inhibitor concentration [I] yields a straight line. The experiment is repeated at different fixed concentrations of the substrate. The resulting set of lines intersects to the left of the y-axis. For *competitive* inhibition, a perpendicular dropped to the x-axis from the point of intersection of the lines gives $-K_i$ (Figure 8-12, top). For *noncompetitive* inhibition the intercept

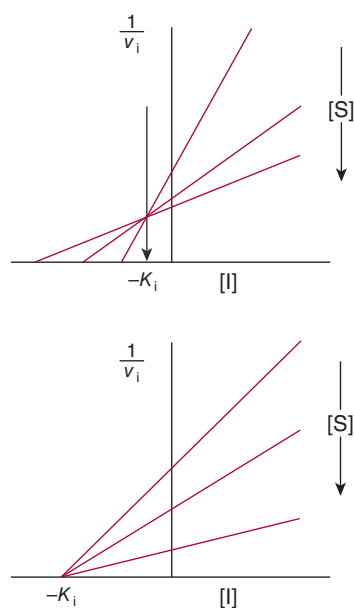

FIGURE 8-12 Applications of Dixon plots. **Top:** competitive inhibition, estimation of K_i . **Bottom:** noncompetitive inhibition, estimation of K_i .

on the x-axis is $-K_i$ (Figure 8-12, bottom). Pharmaceutical publications frequently employ Dixon plots to illustrate the comparative potency of competitive inhibitors.

IC_{50}

A less rigorous alternative to K_i as a measure of inhibitory potency is the concentration of inhibitor that produces 50% inhibition, IC_{50} . Unlike the equilibrium dissociation constant K_i , the numeric value of IC_{50} varies as a function of the specific circumstances of substrate concentration, etc. under which it is determined.

Tightly Bound Inhibitors

Some inhibitors bind to enzymes with such high affinity, $K_i \leq 10^{-9}$ M, that the concentration of inhibitor required to measure K_i falls below the concentration of enzyme typically present in an assay. Under these circumstances, a significant fraction of the total inhibitor may be present as an EI complex. If so, this violates the assumption, implicit in classical steady-state kinetics, that the concentration of free inhibitor is independent of the concentration of enzyme. The kinetic analysis of these tightly bound inhibitors requires specialized kinetic equations that incorporate the concentration of enzyme to estimate K_i or IC_{50} and to distinguish competitive from noncompetitive tightly bound inhibitors.

Irreversible Inhibitors “Poison” Enzymes

In the above examples, the inhibitors form a dissociable, dynamic complex with the enzyme. Fully active enzyme can therefore be recovered simply by removing the inhibitor from the surrounding medium. However, a variety of other inhibitors act *irreversibly* by chemically modifying the enzyme. These modifications generally involve making or breaking covalent bonds with aminoacyl residues essential for substrate binding, catalysis, or maintenance of the enzyme’s functional conformation. Since these covalent changes are relatively stable, an enzyme that has been “poisoned” by an irreversible inhibitor such as a heavy metal atom or an acylating reagent remains inhibited even after the removal of the remaining inhibitor from the surrounding medium.

Mechanism-Based Inhibition

“Mechanism-based” or “suicide” inhibitors are specialized substrate analogs that contain a chemical group that can be transformed by the catalytic machinery of the target enzyme. After binding to the active site, catalysis by the enzyme generates a highly reactive group that forms a covalent bond to and **blocks the function of a catalytically essential residue**. The specificity and persistence of suicide inhibitors, which are both enzyme-specific and unreactive outside the confines of the enzyme’s active site, render them promising leads for the development of enzyme-specific drugs. The kinetic analysis of suicide inhibitors lies beyond the scope of this chapter. Neither the

Lineweaver-Burk nor the Dixon approach is applicable since suicide inhibitors violate a key boundary condition common to both approaches, namely that the activity of the enzyme does not decrease during the course of the assay.

MOST ENZYME-CATALYZED REACTIONS INVOLVE TWO OR MORE SUBSTRATES

While several enzymes have a single substrate, many others have two—and sometimes more—substrates and products. The fundamental principles discussed above, while illustrated for single-substrate enzymes, apply also to multisubstrate enzymes. The mathematical expressions used to evaluate multisubstrate reactions are, however, complex. While a detailed analysis of the full range of multisubstrate reactions exceeds the scope of this chapter, some common types of kinetic behavior for two-substrate, two-product reactions (termed “Bi-Bi” reactions) are considered below.

Sequential or Single-Displacement Reactions

In **sequential reactions**, both substrates must combine with the enzyme to form a ternary complex before catalysis can proceed (Figure 8-13, top). Sequential reactions are sometimes referred to as single-displacement reactions because the group undergoing transfer is usually passed directly, in a single step, from one substrate to the other. Sequential Bi-Bi reactions can be further distinguished on the basis of whether the two substrates add in a **random** or in a **compulsory** order. For random-order reactions, either substrate A or substrate B may combine first with the enzyme to form an EA or an EB complex (Figure 8-13, center). For compulsory-order reactions, A must first combine with E before B can combine with the EA complex. One explanation for why some enzymes follow a compulsory-order mechanism can be found in Koshland's induced fit hypothesis: the addition of A induces a conformational change in the enzyme that aligns residues that recognize and bind B.

Ping-Pong Reactions

The term “**ping-pong**” applies to mechanisms in which one or more products are released from the enzyme before all the substrates have been added. Ping-pong reactions involve covalent catalysis and a transient, modified form of the enzyme (see Figure 7-4). Ping-pong Bi-Bi reactions are often referred to as **double displacement reactions**. The group undergoing transfer is first displaced from substrate A by the enzyme to form product P and a modified form of the enzyme (F). The subsequent group transfer from F to the second substrate B, forming product Q and regenerating E, constitutes the second displacement (Figure 8-13, bottom).

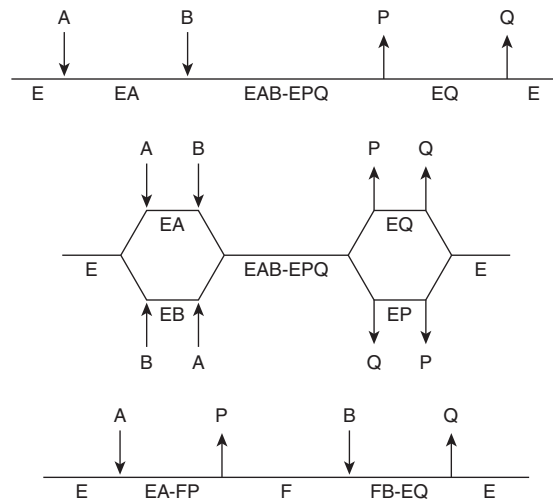

FIGURE 8-13 Representations of three classes of Bi-Bi reaction mechanisms. Horizontal lines represent the enzyme. Arrows indicate the addition of substrates and departure of products. **Top:** an ordered Bi-Bi reaction, characteristic of many NAD(P)H-dependent oxidoreductases. **Center:** a random Bi-Bi reaction, characteristic of many kinases and some dehydrogenases. **Bottom:** a ping-pong reaction, characteristic of aminotransferases and serine proteases.

Most Bi-Bi Reactions Conform to Michaelis-Menten Kinetics

Most Bi-Bi reactions conform to a somewhat more complex form of Michaelis-Menten kinetics in which V_{\max} refers to the reaction rate attained when *both* substrates are present at saturating levels. Each substrate has its own characteristic K_m value, which corresponds to the concentration that yields half-maximal velocity when the second substrate is present at saturating levels. As for single-substrate reactions, double-reciprocal plots can be used to determine V_{\max} and K_m . v_i is measured as a function of the concentration of one substrate (the variable substrate) while the concentration of the other substrate (the fixed substrate) is maintained constant. If the lines obtained for several fixed-substrate concentrations are plotted on the same graph, it is possible to distinguish a ping-pong mechanism, which yields parallel lines (Figure 8-14), from a sequential mechanism, which yields a pattern of intersecting lines (not shown).

Product inhibition studies are used to complement kinetic analyses and to distinguish between ordered and random Bi-Bi reactions. For example, in a random-order Bi-Bi reaction, each product will act as a competitive inhibitor in the absence of its coproducts regardless of which substrate is designated the variable substrate. However, for a sequential mechanism (Figure 8-13, top), only product Q will give the pattern indicative of competitive inhibition when A is the variable substrate, while only product P will produce this pattern with B as the variable substrate. The other combinations of product inhibitor and variable substrate will produce forms of complex noncompetitive inhibition.

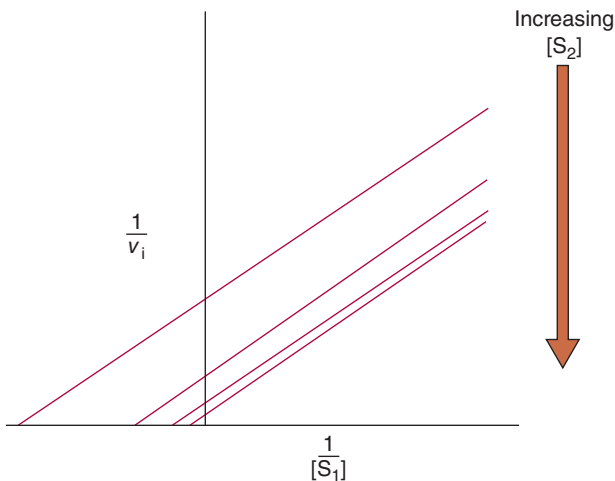

FIGURE 8-14 Lineweaver-Burk plot for a two-substrate ping-pong reaction. Increasing the concentration of one substrate (S_1) while maintaining that of the other substrate (S_2) constant alters both the x and y intercepts, but not the slope.

KNOWLEDGE OF ENZYME KINETICS, MECHANISM, AND INHIBITION AIDS DRUG DEVELOPMENT

Many Drugs Act as Enzyme Inhibitors

The goal of pharmacology is to identify agents that can

1. Destroy or impair the growth, invasiveness, or development of invading pathogens.
2. Stimulate endogenous defense mechanisms.
3. Halt or impede aberrant molecular processes triggered by genetic, environmental, or biologic stimuli with minimal perturbation of the host's normal cellular functions.

By virtue of their diverse physiologic roles and high degree of substrate selectivity, enzymes constitute natural targets for the development of pharmacologic agents that are both potent and specific. Statin drugs, for example, lower cholesterol production by inhibiting 3-hydroxy-3-methylglutaryl coenzyme A reductase (see Chapter 26), while emtricitabine and tenofovir disoproxil fumarate block replication of the human immunodeficiency virus by inhibiting the viral reverse transcriptase (see Chapter 34). Pharmacologic treatment of hypertension often includes the administration of an inhibitor of angiotensin-converting enzyme, thus lowering the level of angiotensin II, a vasoconstrictor (see Chapter 42).

Enzyme Kinetics Defines Appropriate Screening Conditions

Enzyme kinetics plays a crucial role in drug discovery. Knowledge of the kinetic behavior of the enzyme of interest is necessary, first and foremost, to select appropriate assay

conditions for detecting the presence of an inhibitor. The concentration of substrate, for example, must be adjusted such that sufficient product is generated to permit facile detection of the enzyme's activity without being so high that it masks the presence of an inhibitor. Second, enzyme kinetics provides the means for quantifying and comparing the potency of different inhibitors and defining their mode of action. Noncompetitive inhibitors are particularly desirable, because—by contrast to competitive inhibitors—their effects can never be completely overcome by increases in substrate concentration.

Most Drugs Are Metabolized In Vivo

Drug development often involves more than the kinetic evaluation of the interaction of inhibitors with the target enzyme. In order to minimize its effective dosage, and hence the potential for deleterious side effects, a drug needs to be resistant to degradation by enzymes present in the patient or pathogen, a process termed **drug metabolism**. For example, penicillin and other β -lactam antibiotics block cell wall synthesis in bacteria by irreversibly inactivating the enzyme alanine carboxypeptidase-transpeptidase. Many bacteria, however, produce β -lactamases that hydrolyze the critical β -lactam function in penicillin and related drugs. One strategy for overcoming the resulting antibiotic resistance is to simultaneously administer a β -lactamase inhibitor with a β -lactam antibiotic.

Metabolic transformation is sometimes required to convert an inactive drug precursor, or **prodrug**, into its biologically active form (see Chapter 47). 2'-Deoxy-5-fluorouridylic acid, a potent inhibitor of thymidylate synthase, a common target of cancer chemotherapy, is produced from 5-fluorouracil via a series of enzymatic transformations catalyzed by a phosphoribosyl transferase and the enzymes of the deoxyribonucleoside salvage pathway (see Chapter 33). The effective design and administration of prodrugs requires knowledge of the kinetics and mechanisms of the enzymes responsible for transforming them into their biologically active forms.

SUMMARY

- The study of enzyme kinetics—the factors that affect the rates of enzyme-catalyzed reactions—reveals the individual steps by which enzymes transform substrates into products.
- ΔG , the overall change in free energy for a reaction, is independent of reaction mechanism and provides no information concerning *rates* of reactions.
- K_{eq} , a ratio of reaction *rate constants*, may be calculated from the concentrations of substrates and products at equilibrium or from the ratio k_1/k_{-1} . Enzymes do *not* affect K_{eq} .
- Reactions proceed via transition states, for whose formation the activation energy is referred to as ΔG_f . Temperature, hydrogen ion concentration, enzyme concentration, substrate concentration, and inhibitors all affect the rates of enzyme-catalyzed reactions.

- Measurement of the rate of an enzyme-catalyzed reaction generally employs initial rate conditions, for which the virtual absence of product effectively precludes the reverse reaction from taking place.
- Linear forms of the Michaelis-Menten equation simplify determination of K_m and V_{max} .
- A linear form of the Hill equation is used to evaluate the cooperative substrate-binding kinetics exhibited by some multimeric enzymes. The slope n , the Hill coefficient, reflects the number, nature, and strength of the interactions of the substrate-binding sites. A value of n greater than 1 indicates positive cooperativity.
- The effects of simple competitive inhibitors, which typically resemble substrates, are overcome by raising the concentration of the substrate. Simple noncompetitive inhibitors lower V_{max} but do not affect K_m .
- For simple competitive and noncompetitive inhibitors, the inhibitory constant K_i is equal to the dissociation constant for the relevant enzyme-inhibitor complex. A simpler and less rigorous term widely used in pharmaceutical publications for evaluating the effectiveness of an inhibitor is IC_{50} , the concentration of inhibitor that produces 50% inhibition under the particular circumstances of an experiment.
- Substrates may add in a random order (either substrate may combine first with the enzyme) or in a compulsory order (substrate A must bind before substrate B).
- In ping-pong reactions, one or more products are released from the enzyme before all the substrates have been added.
- Applied enzyme kinetics facilitate the identification, characterization and elucidation of the mode of action of drugs that selectively inhibit specific enzymes.
- Enzyme kinetics plays a central role in the analysis and optimization of drug metabolism, a key determinant of drug efficacy.

REFERENCES

- Cook PF, Cleland WW: *Enzyme Kinetics and Mechanism*. Garland Science, 2007.
- Copeland RA: *Evaluation of Enzyme Inhibitors in Drug Discovery*. John Wiley & Sons, 2005.
- Cornish-Bowden A: *Fundamentals of Enzyme Kinetics*. Portland Press Ltd, 2004.
- Dixon M: The determination of enzyme inhibitor constants. *Biochem J* 1953;55:170.
- Dixon M: The graphical determination of K_m and K_i . *Biochem J* 1972;129:197.
- Fersht A: *Structure and Mechanism in Protein Science: A Guide to Enzyme Catalysis and Protein Folding*. Freeman, 1999.
- Fraser CM, Rappuoli R: Application of microbial genomic science to advanced therapeutics. *Annu Rev Med* 2005;56:459.
- Henderson PJF: A linear equation that describes the steady-state kinetics of enzymes and subcellular particles interacting with tightly bound inhibitors. *Biochem J* 1972;127:321.
- Schramm, VL: Enzymatic transition-state theory and transition-state analogue design. *J Biol Chem* 2007;282:28297.
- Schultz AR: *Enzyme Kinetics: From Diastase to Multi-enzyme Systems*. Cambridge University Press, 1994.
- Segel IH: *Enzyme Kinetics*. Wiley Interscience, 1975.
- Wlodawer A: Rational approach to AIDS drug design through structural biology. *Annu Rev Med* 2002;53:595.

Enzymes: Regulation of Activities

Peter J. Kennelly, PhD & Victor W. Rodwell, PhD

OBJECTIVES

After studying this chapter, you should be able to:

- Explain the concept of whole-body homeostasis and its response to fluctuations in the external environment.
- Discuss why the cellular concentrations of substrates for most enzymes tend to be close to K_m .
- List multiple mechanisms by which active control of metabolite flux is achieved.
- Describe the advantages of certain enzymes being elaborated as proenzymes.
- Illustrate the physiologic events that trigger the conversion of a proenzyme to the corresponding active enzyme.
- Describe typical structural changes that accompany conversion of a proenzyme to the active enzyme.
- Describe the basic features of a typical binding site for metabolites and second messengers that regulate catalytic activity of certain enzymes.
- Indicate two general ways in which an allosteric effector can influence catalytic activity.
- Outline the roles of protein kinases, protein phosphatases, and of regulatory and hormonal and second messengers in regulating a metabolic process.
- Explain how the substrate requirements of lysine acetyltransferases and sirtuins can trigger shifts in the degree of lysine acetylation of metabolic enzymes.
- Describe two ways by which regulatory networks can be constructed in cells.

BIOMEDICAL IMPORTANCE

The 19th-century physiologist Claude Bernard enunciated the conceptual basis for metabolic regulation. He observed that living organisms respond in ways that are both quantitatively and temporally appropriate to permit them to survive the multiple challenges posed by changes in their external and internal environments. Walter Cannon subsequently coined the term “homeostasis” to describe the ability of animals to maintain a constant intracellular environment despite changes in their external surroundings. We now know that organisms respond to changes in their external and internal environment by balanced, coordinated adjustments in the rates of specific metabolic reactions. Metabolic intermediates such as 5'-AMP and NAD⁺, as well as byproducts such as reactive oxygen species, serve as internal indicators of cellular status. Signal transduction cascades connect the receptors that sense external factors with appropriate intracellular proteins to initiate adaptive responses.

Perturbations of the sensor-response machinery responsible for maintaining homeostatic balance can be deleterious to human health. Cancer, diabetes, cystic fibrosis, and Alzheimer's disease, for example, are all characterized by regulatory dysfunctions triggered by the interplay between pathogenic agents, genetic mutations, nutritional inputs, and lifestyle practices. Many oncogenic viruses elaborate protein-tyrosine kinases that modify the regulatory events that control patterns of gene expression, contributing to the initiation and progression of cancer. The toxin from *Vibrio cholerae*, the causative agent of cholera, disables sensor-response pathways in intestinal epithelial cells by ADP-ribosylating the GTP-binding proteins (G-proteins) that link cell surface receptors to adenyl cyclase. The consequent activation of the cyclase leads to the unrestricted flow of water into the intestines, resulting in massive diarrhea and dehydration. *Yersinia pestis*, the causative agent of plague, elaborates a protein-tyrosine phosphatase that

hydrolyzes phosphoryl groups on key cytoskeletal proteins. Dysfunctions in the proteolytic systems responsible for the degradation of defective or abnormal proteins are believed to play a role in neurodegenerative diseases such as Alzheimer's and Parkinson's. In addition to their immediate function as regulators of enzyme activity, protein degradation, etc, covalent modifications such as phosphorylation, acetylation, and ubiquitination provide a protein-based code for the storage and hereditary transmission of information (see Chapter 35). Such DNA-independent information systems are referred to as **epigenetic**. Knowledge of factors that control the rates of enzyme-catalyzed reactions thus is essential to an understanding of the molecular basis of disease and its transmission. This chapter outlines the patterns by which metabolic processes are controlled, and provides illustrative examples. Subsequent chapters provide additional examples.

REGULATION OF METABOLITE FLOW CAN BE ACTIVE OR PASSIVE

Enzymes that operate at their maximal rate cannot increase throughput to accommodate surges in substrate availability, and can respond only to precipitous decreases in substrate concentration. The K_m values for most enzymes, therefore, tend to be close to the average intracellular concentration of their substrates, so that changes in substrate concentration generate corresponding changes in metabolite flux (**Figure 9-1**). Responses to changes in substrate level represent an important but *passive* means for coordinating metabolite flow. However, their capacity for responding to changes in environmental variables is limited. The mechanisms that regulate enzyme efficiency in an *active* manner in response to internal and external signals are discussed below.

Metabolite Flow Tends to Be Unidirectional

Despite the existence of short-term oscillations in metabolite concentrations and enzyme levels, living cells exist in a dynamic steady state in which the mean concentrations of metabolic

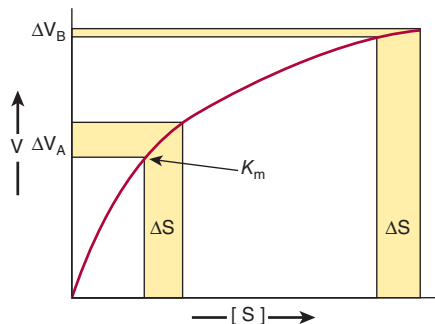

FIGURE 9-1 Differential response of the rate of an enzyme-catalyzed reaction, ΔV , to the same incremental change in substrate concentration at a substrate concentration close to K_m (ΔV_A) or far above K_m (ΔV_B).

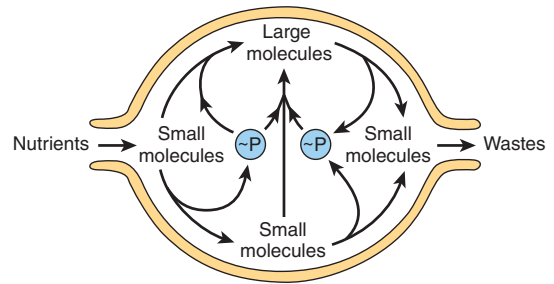

FIGURE 9-2 An idealized cell in steady state. Note that metabolite flow is unidirectional.

intermediates remain relatively constant over time. While all chemical reactions are to some extent reversible, in living cells the reaction products serve as substrates for—and are removed by—other enzyme-catalyzed reactions (**Figure 9-2**). Many nominally reversible reactions thus occur unidirectionally. This succession of coupled metabolic reactions is accompanied by an *overall* change in free energy that favors unidirectional metabolite flow analogous to the flow of water through a pipe in which one end is lower than the other. Bends or kinks in the pipe simulate individual enzyme-catalyzed steps with a small negative or positive change in free energy. Flow of water through the pipe nevertheless remains unidirectional due to the overall change in height, which corresponds to the overall change in free energy in a pathway (**Figure 9-3**).

COMPARTMENTATION ENSURES METABOLIC EFFICIENCY & SIMPLIFIES REGULATION

In eukaryotes, the anabolic and catabolic pathways that synthesize and break down common biomolecules often are physically separated from one another. Certain metabolic pathways reside only within specialized cell types or, within a cell, inside distinct subcellular compartments. For example, many of the enzymes that degrade proteins and polysaccharides

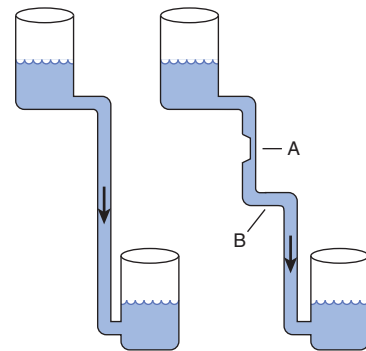

FIGURE 9-3 Hydrostatic analogy for a pathway with a rate-limiting step (A) and a step with a ΔG value near 0 (B).

reside inside organelles called lysosomes. Similarly, fatty acid biosynthesis occurs in the cytosol, whereas fatty acid oxidation takes place within mitochondria (see Chapters 22 and 23). Fortunately, many apparently antagonistic pathways can coexist in the absence of physical barriers, provided that thermodynamics dictates that each proceeds with the formation of one or more *unique intermediates*. For any reaction or series of reactions, the change in free energy that takes place when metabolite flow proceeds in the “forward” direction is equal in magnitude *but opposite in sign* from that required to proceed in the reverse direction. Some enzymes within these pathways catalyze reactions, such as isomerizations, that can act as bidirectional catalysts *in vivo* because the difference in free energy between substrates and products is close to zero. However, they represent the exception rather than the rule. Virtually all metabolic pathways proceed via one or more steps for which ΔG is significant. For example, glycolysis, the breakdown of glucose to form two molecules of pyruvate, has a favorable overall ΔG of -96 kJ/mol, a value much too large to simply operate in “reverse” when wishing to convert excess pyruvate to glucose. Consequently, gluconeogenesis proceeds via a pathway in which the three most energetically disfavored steps from glycolysis are replaced by new reactions catalyzed by distinct enzymes (see Chapter 19).

The ability of enzymes to discriminate between the structurally similar coenzymes NAD^+ and NADP^+ also results in a form of compartmentation. The reduction potentials of both coenzymes are similar. However, nearly all of the enzymes catalyzing the reactions that generate the electrons destined for the electron transport chain reduce NAD^+ , while enzymes that catalyze the reductive steps in many biosynthetic pathways generally use NADPH as the electron donor.

Controlling an Enzyme That Catalyzes a Rate-Limiting Reaction Regulates an Entire Metabolic Pathway

While the flux of metabolites through metabolic pathways involves catalysis by numerous enzymes, active control of homeostasis is achieved by the regulation of only a select subset of these enzymes. The ideal enzyme for regulatory intervention is one whose quantity or catalytic efficiency dictates that the reaction it catalyzes is slow relative to all others in the pathway. Decreasing the catalytic efficiency or the quantity of the catalyst responsible for the “bottleneck” or **rate-limiting reaction** will immediately reduce metabolite flux through the entire pathway. Conversely, an increase in either its quantity or catalytic efficiency will enhance flux through the pathway as a whole. For example, acetyl-CoA carboxylase catalyzes the synthesis of malonyl-CoA, the first committed reaction of fatty acid biosynthesis (see Chapter 23). When synthesis of malonyl-CoA is inhibited, subsequent reactions of fatty acid synthesis cease for lack of substrates. As natural “governors” of metabolic flux, the enzymes that catalyze rate-limiting steps also constitute efficient targets for regulatory intervention by drugs. For example, “statin” drugs curtail synthesis of

cholesterol by inhibiting HMG-CoA reductase, catalyst of the rate-limiting reaction of cholesterol synthesis.

REGULATION OF ENZYME QUANTITY

The catalytic capacity of the rate-limiting reaction in a metabolic pathway is the product of the concentration of enzyme molecules and their intrinsic catalytic efficiency. It therefore follows that catalytic capacity can be controlled by changing the quantity of enzyme present, altering its intrinsic catalytic efficiency, or a combination thereof.

Proteins Are Continuously Synthesized and Degraded

By measuring the rates of incorporation of ^{15}N -labeled amino acids into protein and the rates of loss of ^{15}N from protein, Schoenheimer deduced that proteins exist in a state of “dynamic equilibrium” within our bodies where they are continuously synthesized and degraded—a process referred to as **protein turnover**. This holds even for **constitutive** proteins, those whose concentrations remain essentially constant over time. On the other hand, the concentrations of many enzymes are influenced by a wide range of physiologic, hormonal, or dietary factors.

The absolute quantity of an enzyme reflects the net balance between its rate of synthesis and its rate of degradation. In human subjects, alterations in the levels of specific enzymes can be effected by a change in the rate constant for the overall processes of synthesis (k_s), degradation (k_{deg}), or both.

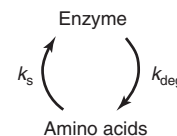

Control of Enzyme Synthesis

The synthesis of certain enzymes depends upon the presence of **inducers**, typically substrates or structurally related compounds that stimulate the transcription of the gene that encodes them (see Chapters 36 and 37). *Escherichia coli* grown on glucose will, for example, only catabolize lactose after addition of a β -galactoside, an inducer that triggers synthesis of a β -galactosidase and a galactoside permease. Inducible enzymes of humans include tryptophan pyrrolase, threonine dehydratase, tyrosine- α -ketoglutarate aminotransferase, enzymes of the urea cycle, HMG-CoA reductase, δ -aminolevulinic synthase, and cytochrome P450. Conversely, an excess of a metabolite may curtail synthesis of its cognate enzyme via **repression**. Both induction and repression involve *cis* elements, specific DNA sequences located upstream of regulated genes, and *trans*-acting regulatory proteins. The molecular mechanisms of induction and repression are discussed in Chapter 38. The synthesis of other enzymes can be stimulated by **transcription factors** whose activity is controlled by the interaction of hormones and other

extracellular signals with specific cell-surface receptors. Detailed information on the control of protein synthesis in response to hormonal stimuli can be found in Chapter 42.

Control of Enzyme Degradation

In animals many proteins are degraded by the ubiquitin-proteasome pathway, the discovery of which earned Aaron Ciechanover, Avram Hershko, and Irwin Rose a Nobel Prize. Degradation takes place in the 26S proteasome, a large macromolecular complex made up of more than 30 polypeptide subunits arranged in the form of a hollow cylinder. The active sites of its proteolytic subunits face the interior of the cylinder, thus preventing indiscriminate degradation of cellular proteins (see cover picture). Proteins are targeted to the interior of the proteasome by “ubiquitination,” the covalent attachment of one or more ubiquitin molecules. Ubiquitin is a small, approximately 8.5 kDa protein that is highly conserved among eukaryotes. Ubiquitination is catalyzed by a large family of enzymes called E3 ligases, which attach ubiquitin to the side-chain amino group of lysyl residues.

The ubiquitin-proteasome pathway is responsible both for the regulated degradation of selected cellular proteins, for example, cyclins (see Chapter 35), and for the removal of defective or aberrant protein species. The key to the versatility and selectivity of the ubiquitin-proteasome system resides in the variety of intracellular E3 ligases and their ability to discriminate between the different physical or conformational states of target proteins. Thus, the ubiquitin-proteasome pathway can selectively degrade proteins whose physical integrity and functional competency have been compromised by the loss of or damage to a prosthetic group, oxidation of cysteine or histidine residues, or deamidation of asparagine or glutamine residues (see Chapter 58). Recognition by proteolytic enzymes also can be regulated by covalent modifications such as phosphorylation; binding of substrates or allosteric effectors; or association with membranes, oligonucleotides, or other proteins. A growing body of evidence suggests that dysfunctions of the ubiquitin-proteasome pathway contribute to the accumulation of the misfolded proteins characteristic of several neurodegenerative diseases.

MULTIPLE OPTIONS ARE AVAILABLE FOR REGULATING CATALYTIC ACTIVITY

In humans the induction of protein synthesis is a complex multistep process that typically requires hours to produce significant changes in overall enzyme level. By contrast, changes in intrinsic catalytic efficiency effected by binding of dissociable ligands (**allosteric regulation**) or by **covalent modification** achieve regulation of enzymic activity within seconds. Consequently, changes in protein level generally dominate when meeting long-term adaptive requirements, whereas changes in catalytic efficiency are favored for rapid and transient alterations in metabolite flux.

ALLOSTERIC EFFECTORS REGULATE CERTAIN ENZYMES

Feedback inhibition refers to the process by which the end product of a multistep biosynthetic pathway binds to and inhibits an enzyme catalyzing one of the early steps in that pathway. In most cases, feedback inhibitors inhibit the enzyme that catalyzes the first committed step in a particular biosynthetic sequence. In the following example, for the biosynthesis of D from A is catalyzed by enzymes Enz_1 through Enz_3 :

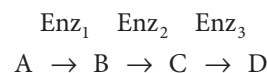

High concentrations of D inhibit the conversion of A to B. In this example, the feedback inhibitor D acts as a **negative allosteric effector** of Enz_1 . Inhibition results, not from the “backing up” of intermediates, but from the ability of D to bind to and inhibit Enz_1 . Generally, D binds at an **allosteric site**, one spatially distinct from the catalytic site of the target enzyme. Feedback inhibitors thus typically bear little or no structural similarity to the substrates of the enzymes they inhibit. For example, NAD^+ and 3-phosphoglycerate, the substrates for 3-phosphoglycerate dehydrogenase, which catalyzes the first committed step in serine biosynthesis, bear no resemblance to the feedback inhibitor serine. In branched biosynthetic pathways, such as those responsible for nucleotide biosynthesis (see Chapter 33), the initial reactions supply intermediates required for the synthesis of multiple end products. **Figure 9-4** shows a hypothetical branched biosynthetic pathway in which curved arrows lead from feedback inhibitors to the enzymes whose activity they inhibit. The sequences $\text{S}_3 \rightarrow \text{A}$, $\text{S}_4 \rightarrow \text{B}$, $\text{S}_4 \rightarrow \text{C}$, and $\text{S}_3 \rightarrow \text{D}$ each represent linear reaction sequences that are feedback-inhibited by their end products. Branch point enzymes thus can be targeted to direct later stages of metabolite flow.

The kinetics of feedback inhibition may be competitive, noncompetitive, partially competitive, or mixed. Layering multiple feedback loops can provide additional fine control. For example, as shown in **Figure 9-5**, the presence of excess product B decreases the requirement for substrate S_2 . However, S_2 is also required for synthesis of A, C, and D. Therefore, for this pathway, excess B curtails synthesis of all four end products, regardless of the need for the other three. To circumvent this potential difficulty, each end product may only *partially*

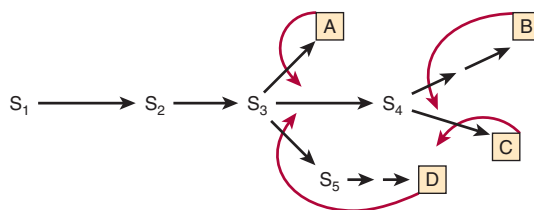

FIGURE 9-4 Sites of feedback inhibition in a branched biosynthetic pathway. S_1 – S_5 are intermediates in the biosynthesis of end products A–D. Straight arrows represent enzymes catalyzing the indicated conversions. Curved red arrows represent feedback loops and indicate sites of feedback inhibition by specific end products.

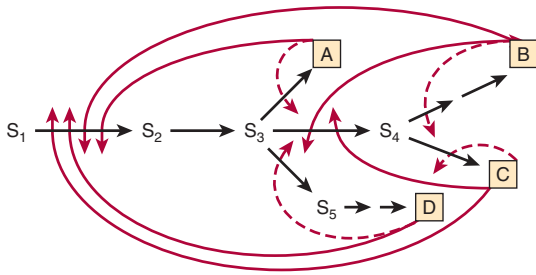

FIGURE 9-5 Multiple feedback inhibition in a branched biosynthetic pathway. Superimposed on simple feedback loops (dashed red arrows) are multiple feedback loops (solid red arrows) that regulate enzymes common to biosynthesis of several end products.

inhibit catalytic activity. The effect of an excess of two or more end products may be strictly additive or, alternatively, greater than their individual effect (cooperative feedback inhibition). Alternatively, for example the branched pathway responsible for the synthesis of the aromatic amino acids phenylalanine, tyrosine, and tryptophan in bacteria, multiple isoforms of an enzyme may evolve, each of which is sensitive to a different pathway end product. High levels of any one end product will inhibit catalysis by only a single isoform, reducing but not eliminating flux through the shared portion of the pathway.

Aspartate Transcarbamoylase Is a Model Allosteric Enzyme

Aspartate transcarbamoylase (ATCase), the catalyst for the first reaction unique to pyrimidine biosynthesis (see Figure 33-9), is a target of feedback regulation by two nucleotide triphosphates: cytidine triphosphate (CTP) and adenosine triphosphate. CTP, an end product of the pyrimidine biosynthetic pathway, inhibits ATCase, whereas the purine nucleotide ATP activates it. Moreover, high levels of ATP can overcome inhibition by CTP, enabling synthesis of *pyrimidine* nucleotides to proceed when *purine* nucleotide levels are elevated.

Allosteric & Catalytic Sites Are Spatially Distinct

Jacques Monod proposed the existence of allosteric sites that are physically distinct from the catalytic site. He reasoned that the lack of structural similarity between most feedback inhibitors and the substrate(s) for the enzymes whose activities they regulate indicated that these effectors are not **isosteric** with a substrate but **allosteric** (“occupy another space”). **Allosteric enzymes thus are those for which catalysis at the active site may be modulated by the presence of effectors at an allosteric site.** The existence of spatially distinct active and allosteric sites has since been verified in several enzymes using many lines of evidence. For example, x-ray crystallography revealed that the ATCase of *E coli* consists of six catalytic subunits and six regulatory subunits, the latter of which bind the nucleotide triphosphates that modulate activity. In general, binding of an allosteric regulator influences catalysis by inducing a conformational change that encompasses the active site.

Allosteric Effects May Be on K_m or on V_{max}

To refer to the kinetics of allosteric inhibition as “competitive” or “noncompetitive” with substrate carries misleading mechanistic implications. We refer instead to two classes of allosterically regulated enzymes: K-series and V-series enzymes. For K-series allosteric enzymes, the substrate saturation kinetics is competitive in the sense that K_m is raised without an effect on V_{max} . For V-series allosteric enzymes, the allosteric inhibitor lowers V_{max} without affecting the K_m . Alterations in K_m or V_{max} often are the product of conformational changes at the catalytic site induced by binding of the allosteric effector at its site. For a K-series allosteric enzyme, this conformational change may weaken the bonds between substrate and substrate-binding residues. For a V-series allosteric enzyme, the primary effect may be to alter the orientation or charge of catalytic residues, lowering V_{max} . Intermediate effects on K_m and V_{max} , however, may be observed consequent to these conformational changes.

FEEDBACK REGULATION CAN BE EITHER STIMULATORY OR INHIBITORY

In both mammalian and bacterial cells, some pathway end products “feed back” to control their own synthesis, in many instances by feedback inhibition of an early biosynthetic enzyme. We must, however, distinguish between **feedback regulation**, a phenomenologic term devoid of mechanistic implications, and **feedback inhibition**, a mechanism for regulation of enzyme activity. For example, while dietary cholesterol decreases hepatic synthesis of cholesterol, this **feedback regulation** does not involve **feedback inhibition**. HMG-CoA reductase, the rate-limiting enzyme of cholesterologenesis, is affected, but cholesterol does not inhibit its activity. Rather, regulation in response to dietary cholesterol involves curtailment by cholesterol or a cholesterol metabolite of the expression of the gene that encodes HMG-CoA reductase (enzyme repression) (see Chapter 26). As mentioned above, ATP, a product of the purine nucleotide pathway, stimulates the synthesis of pyrimidine nucleotides by activating aspartate transcarbamoylase, a process sometimes referred to as “feed forward” regulation.

MANY HORMONES ACT VIA SECOND MESSENGERS

Nerve impulses and the binding of many hormones to cell surface receptors elicit changes in the rate of enzyme-catalyzed reactions within target cells by inducing the release or synthesis of specialized allosteric effectors called **second messengers**. The primary, or “first,” messenger is the hormone molecule or nerve impulse. Second messengers include 3', 5'-cAMP, synthesized from ATP by the enzyme adenylyl cyclase in response to the hormone epinephrine, and Ca^{2+} , which is stored inside the endoplasmic reticulum of most cells. Membrane depolarization resulting from a nerve impulse opens a membrane

channel that releases calcium ions into the cytoplasm, where they bind to and activate enzymes involved in the regulation of muscle contraction and the mobilization of stored glucose from glycogen to supply the increased energy demands of muscle contraction. Other second messengers include 3',5'-cGMP, nitric oxide, and the polyphosphoinositols produced by the hydrolysis of inositol phospholipids by hormone-regulated phospholipases. Specific examples of the participation of second messengers in the regulation of cellular processes can be found in Chapters 18, 42, and 50.

REGULATORY COVALENT MODIFICATIONS CAN BE REVERSIBLE OR IRREVERSIBLE

In mammalian cells, a wide range of regulatory covalent modifications occur. **Partial proteolysis** and **phosphorylation**, for example, are frequently employed to regulate the catalytic activity of enzymes. On the other hand, histones and other DNA-binding proteins in chromatin are subject to extensive modification by **acetylation**, **methylation**, **ADP-ribosylation**, as well as phosphorylation. The latter modifications, which modulate the manner in which the proteins within chromatin interact with each other as well as the DNA itself, constitute the basis for the “histone code.” The resulting changes in chromatin structure within the region affected can render genes more accessible to the proteins responsible for their transcription, thereby enhancing gene expression or, on a larger scale, facilitating replication of the entire genome (see Chapter 38). On the other hand, changes in chromatin structure that restrict the accessibility of genes to transcription factors, DNA-dependent RNA polymerases, etc, thereby inhibiting transcription, are said to **silence** gene expression.

The Histone Code

The “histone code” represents a classic example of **epigenetics**, the hereditary transmission of information by a means other than the sequence of nucleotides that comprise the genome. In this instance, the pattern of gene expression within a newly formed “daughter” cell will be determined, in part, by the particular set of histone covalent modifications embodied in the chromatin proteins inherited from the “parental” cell.

Reversible Covalent Modification

Acetylation, ADP-ribosylation, methylation, and phosphorylation are all examples of “reversible” covalent modifications. In this context, reversible refers to the fact that the modified protein can be restored to its original, modification-free state, not the mechanism by which restoration takes place. Thermodynamics dictates that if the enzyme-catalyzed reaction by which the modification was introduced is thermodynamically favorable, simply reversing the process will be rendered impractical by the correspondingly unfavorable free energy change. The phosphorylation of proteins on seryl, threonyl, or tyrosyl residues,

catalyzed by protein kinases, is thermodynamically favored as a consequence of utilizing the high-energy gamma phosphoryl group of ATP. Phosphate groups are removed, not by recombining the phosphate with ADP to form ATP, but by a hydrolytic reaction catalyzed by enzymes called protein phosphatases. Similarly, acetyltransferases employ a high-energy donor substrate, NAD⁺, while deacetylases catalyze a direct hydrolysis that generates free acetate.

PROTEASES MAY BE SECRETED AS CATALYTICALLY INACTIVE PROENZYMES

Certain proteins are synthesized as inactive precursor proteins known as **proproteins**. Selective, or “partial,” proteolysis of a proprotein by one or more successive proteolytic “clips” converts it to a form that exhibits the characteristic activity of the mature protein, for example, its catalytic activity. The proprotein forms of enzymes are termed **proenzymes** or **zymogens**. Proteins synthesized as proproteins include the hormone insulin (proprotein = proinsulin), the digestive enzymes pepsin, trypsin, and chymotrypsin (proproteins = pepsinogen, trypsinogen, and chymotrypsinogen, respectively), several factors of the blood clotting and complement cascades (see Chapters 52 and 55), and the connective tissue protein collagen (proprotein = procollagen).

Proteolytic activation of proproteins constitutes a physiologically irreversible modification because reunification of the two portions of a protein produced by hydrolysis of a peptide bond is entropically disfavored. Once a proprotein is activated, it will continue to carry out its catalytic or other functions until it is removed by degradation or some other means. Zymogen activation thus represents a simple and economical, albeit one way, mechanism for restraining the latent activity of a protein until the appropriate circumstances are encountered. It is therefore not surprising that partial proteolysis is employed frequently to regulate proteins that work in the gastrointestinal tract or bloodstream rather than in the interior of cells.

Proenzymes Facilitate Rapid Mobilization of an Activity in Response to Physiologic Demand

The synthesis and secretion of proteases as catalytically inactive proenzymes protect the tissue of origin (eg, the pancreas) from autodigestion, such as can occur in pancreatitis. Certain physiologic processes such as digestion are intermittent but fairly regular and predictable in frequency. Others such as blood clot formation, clot dissolution, and tissue repair are brought “on line” only in response to pressing physiologic or pathophysiologic need. The processes of blood clot formation and dissolution clearly must be temporally coordinated to achieve homeostasis. Enzymes needed intermittently but rapidly often are secreted in an initially inactive form since new synthesis and secretion of the required proteins might be

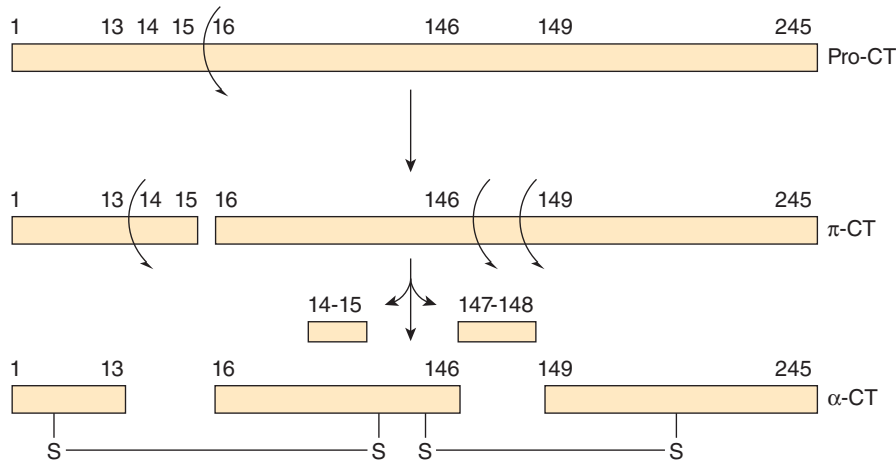

FIGURE 9-6 Two-dimensional representation of the sequence of proteolytic events that ultimately result in formation of the catalytic site of chymotrypsin, which includes the Asp 102-His57-Ser195 catalytic triad (see Figure 7-7). Successive proteolysis forms prochymotrypsin (pro-CT), π -chymotrypsin (π -Ct), and ultimately α -chymotrypsin (α -CT), an active protease whose three peptides (A, B, C) remain associated by covalent inter-chain disulfide bonds.

insufficiently rapid to respond to a pressing pathophysiologic demand such as the loss of blood (see Chapter 55).

Activation of Prochymotrypsin Requires Selective Proteolysis

Selective proteolysis involves one or more highly specific proteolytic clips that may or may not be accompanied by separation of the resulting peptides. Most importantly, selective proteolysis often results in conformational changes that properly configure an enzyme's active site. Note that while the catalytically essential residues His 57 and Asp 102 reside on the B peptide of α -chymotrypsin, Ser 195 resides on the C peptide (Figure 9-6). The conformational changes that accompany selective proteolysis of prochymotrypsin (chymotrypsinogen) align the three residues of the charge-relay network (see Figure 7-7), forming the catalytic site. Note also that contact and catalytic residues can be located on different peptide chains but still be within bond-forming distance of bound substrate.

REVERSIBLE COVALENT MODIFICATION REGULATES KEY MAMMALIAN PROTEINS

Thousands of Mammalian Proteins Are Modified by Covalent Phosphorylation

Mammalian proteins are the targets of a wide range of covalent modification processes. Modifications such as prenylation, glycosylation, hydroxylation, and fatty acid acylation introduce unique structural features into newly synthesized proteins that tend to persist for the lifetime of the protein. Among the covalent modifications that regulate protein function, the most common by far are phosphorylation-dephosphorylation

and acetylation-deacetylation. **Protein kinases** phosphorylate proteins by catalyzing transfer of the terminal phosphoryl group of ATP to the hydroxyl groups of seryl, threonyl, or tyrosyl residues, forming *O*-phosphoseryl, *O*-phosphothreonyl, or *O*-phosphotyrosyl residues, respectively (Figure 9-7). Some protein kinases target the side chains of histidyl, lysyl, arginyl, and aspartyl residues. The unmodified form of the protein can be regenerated by hydrolytic removal of phosphoryl groups, catalyzed by **protein phosphatases**. A typical mammalian cell possesses thousands of phosphorylated proteins and several hundred protein kinases and protein phosphatases that catalyze their interconversion. The ease of interconversion of enzymes between their phospho- and dephospho- forms accounts, in part, for the frequency with which phosphorylation-dephosphorylation is utilized as a mechanism for regulatory control. Phosphorylation-dephosphorylation permits the functional properties of the affected enzyme to be altered only for as long as it serves a specific need. Once the need has passed, the enzyme can be converted back to its original form, poised to respond to the next stimulatory event. A second factor underlying the widespread use of protein phosphorylation-dephosphorylation lies in the chemical properties of the phosphoryl group itself. In order to alter an enzyme's functional properties, any modification of its chemical structure must influence the protein's

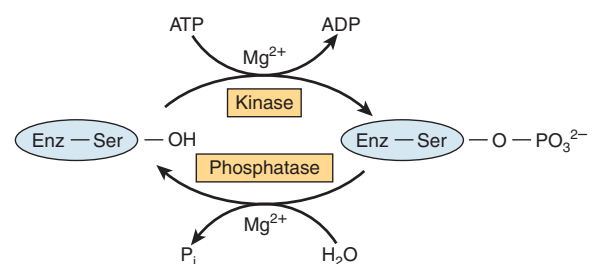

FIGURE 9-7 Covalent modification of a regulated enzyme by phosphorylation-dephosphorylation of a seryl residue.

three-dimensional configuration. The high charge density of protein-bound phosphoryl groups—generally -2 at physiologic pH—and their propensity to form strong salt bridges with arginyl and lysyl residues renders them potent agents for modifying protein structure and function. Phosphorylation generally influences an enzyme's intrinsic catalytic efficiency or other properties by inducing conformational changes. Consequently, the amino acids targeted by phosphorylation can be and typically are relatively distant from the catalytic site itself.

Protein Acetylation: A Ubiquitous Modification of Metabolic Enzymes

Covalent acetylation-deacetylation has long been associated with histones and other nuclear proteins. In recent years, however, proteomic studies have revealed that thousands of other mammalian proteins are subject to modification by covalent acetylation, including nearly every enzyme present in key metabolic pathways such as glycolysis, glycogen synthesis, gluconeogenesis, the tricarboxylic acid cycle, β -oxidation of fatty acids, and the urea cycle. The potential regulatory impact of acetylation-deacetylation has been established for only a handful of these proteins. However, they include many metabolically important enzymes, such as acetyl-CoA synthetase, long-chain acyl-CoA dehydrogenase, malate dehydrogenase, isocitrate dehydrogenase, glutamate dehydrogenase, carbamoyl phosphate synthetase, and ornithine transcarbamoylase.

Lysine acetyltransferases catalyze the transfer of the acetyl group of acetyl-CoA to the ϵ -amino groups of lysyl residues, forming *N*-acetyl lysine. In addition, some proteins, particularly those in the mitochondria, become acetylated by reacting with acetyl-CoA directly, ie, without the intervention of an enzyme catalyst. Acetylation not only increases the steric bulk of the lysine side chain, it transforms a basic and potentially positively charged primary amine into a neutral, nonionizable amide. Two classes of protein deacetylases have been identified: **histone deacetylases** and **sirtuins**. Histone deacetylases catalyze the removal by hydrolysis of acetyl groups, regenerating the unmodified form of the protein and acetate as products. Sirtuins, on the other hand, use NAD^+ as substrate, which yields *O*-acetyl ADP-ribose and nicotinamide as products in addition to the unmodified protein.

Covalent Modifications Regulate Metabolite Flow

In many respects, sites of protein phosphorylation, acetylation, and other covalent modifications can be considered another form of allosteric site. However, in this case, the “allosteric ligand” binds covalently to the protein. Phosphorylation-dephosphorylation, acetylation-deacetylation, and feedback inhibition provide short-term, readily reversible regulation of metabolite flow in response to specific physiologic signals. All three act independently of changes in gene expression. Both phosphorylation-dephosphorylation and feedback inhibition generally act on early enzymes of a protracted metabolic pathway, and both act at allosteric rather than catalytic sites. Feedback inhibition, however, involves a single protein that is

influenced indirectly, if at all, by hormonal or neural signals. By contrast, regulation of mammalian enzymes by phosphorylation-dephosphorylation involves several proteins and ATP, and is under direct neural and hormonal control.

Acetylation-deacetylation, on the other hand, targets multiple proteins in a pathway. It has been hypothesized that the degree of acetylation of metabolic enzymes is modulated to a large degree by the energy status of the cell. Under this model, the high levels of acetyl-CoA (the substrate for lysine acetyltransferases and the reactant in non-enzymatic lysine acetylation) present in a well-nourished cell would promote lysine acetylation. When nutrients are lacking, acetyl-CoA levels drop and the ratio of NAD^+/NADH rises, favoring protein deacetylation.

PROTEIN PHOSPHORYLATION IS EXTREMELY VERSATILE

Protein phosphorylation-dephosphorylation is a highly versatile and selective process. Not all proteins are subject to phosphorylation, and of the many hydroxyl groups on a protein's surface, only one or a small subset are targeted. While the most common enzyme function affected is the protein's catalytic efficiency, phosphorylation can also alter its location within the cell, susceptibility to proteolytic degradation, or responsiveness to regulation by allosteric ligands. Phosphorylation can increase an enzyme's catalytic efficiency, converting it to its active form in one protein, while phosphorylation of another protein converts it to an intrinsically inefficient, or inactive form (**Table 9-1**).

Many proteins can be phosphorylated at multiple sites. Others are subject to regulation both by phosphorylation-dephosphorylation and by the binding of allosteric ligands, or by phosphorylation-dephosphorylation and another covalent modification. Phosphorylation-dephosphorylation at any one site can be catalyzed by multiple protein kinases or protein phosphatases. Many protein kinases and most protein phosphatases act on more than one protein and are themselves interconverted between active and inactive forms by the

TABLE 9-1 Examples of Mammalian Enzymes Whose Catalytic Activity Is Altered by Covalent Phosphorylation-Dephosphorylation

Enzyme	Activity State	
	Low	High
Acetyl-CoA carboxylase	EP	E
Glycogen synthase	EP	E
Pyruvate dehydrogenase	EP	E
HMG-CoA reductase	EP	E
Glycogen phosphorylase	E	EP
Citrate lyase	E	EP
Phosphorylase b kinase	E	EP
HMG-CoA reductase kinase	E	EP

Abbreviations: E, dephosphoenzyme; EP, phosphoenzyme.

binding of second messengers or by covalent modification by phosphorylation-dephosphorylation.

The interplay between protein kinases and protein phosphatases, between the functional consequences of phosphorylation at different sites, between phosphorylation sites and allosteric sites, or between phosphorylation sites and other sites of covalent modification provides the basis for regulatory networks that integrate multiple environmental input signals to evoke an appropriate coordinated cellular response. In these sophisticated regulatory networks, individual enzymes respond to different environmental signals. For example, if an enzyme can be phosphorylated at a single site by more than one protein kinase, it can be converted from a catalytically efficient to an inefficient (inactive) form, or vice versa, in response to any one of several signals. If the protein kinase is activated in response to a signal different from the signal that activates the protein phosphatase, the phosphoprotein becomes a *decision node*, whose functional output, generally catalytic activity, reflects the phosphorylation state. This state or degree of phosphorylation is determined by the relative activities of the protein kinase and protein phosphatase, a reflection of the presence and relative strength of the environmental signals that act through each.

The ability of many protein kinases and protein phosphatases to target more than one protein provides a means for an environmental signal to coordinately regulate multiple metabolic processes. For example, the enzymes 3-hydroxy-3-methylglutaryl-CoA reductase and acetyl-CoA carboxylase—the

rate-controlling enzymes for cholesterol and fatty acid biosynthesis, respectively—are phosphorylated and inactivated by the AMP-activated protein kinase. When this protein kinase is activated either through phosphorylation by yet another protein kinase or in response to the binding of its allosteric activator 5'-AMP, the two major pathways responsible for the synthesis of lipids from acetyl-CoA are both inhibited.

INDIVIDUAL REGULATORY EVENTS COMBINE TO FORM SOPHISTICATED CONTROL NETWORKS

Cells carry out a complex array of metabolic processes that must be regulated in response to a broad spectrum of environmental factors. Hence, interconvertible enzymes and the enzymes responsible for their interconversion do not act as isolated “on” and “off” switches. In order to meet the demands of maintaining homeostasis, these building blocks are linked to form integrated regulatory networks.

One well-studied example of such a network is the eukaryotic cell cycle that controls cell division. Upon emergence from the G_0 or quiescent state, the extremely complex process of cell division proceeds through a series of specific phases designated G_1 , S, G_2 , and M (Figure 9–8). Elaborate monitoring systems, called **checkpoints**, assess key indicators of progress

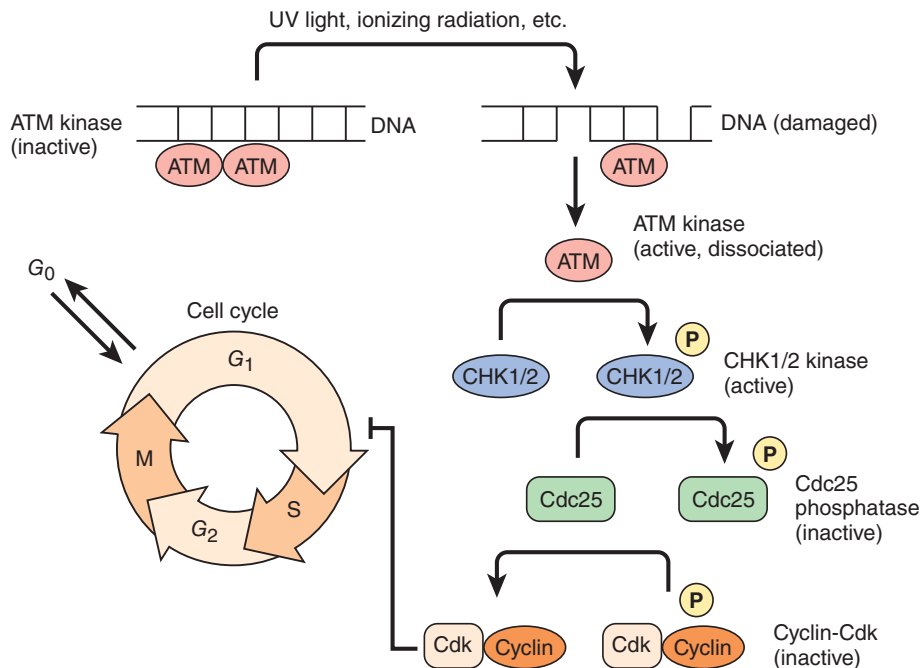

FIGURE 9–8 A simplified representation of the G_1 to S checkpoint of the eukaryotic cell cycle. The circle shows the various stages in the eukaryotic cell cycle. The genome is replicated during S phase, while the two copies of the genome are segregated and cell division occurs during M phase. Each of these phases is separated by a G, or growth, phase characterized by an increase in cell size and the accumulation of the precursors required for the assembly of the large macromolecular complexes formed during S and M phases.

to ensure that no phase of the cycle is initiated until the prior phase is complete. Figure 9–8 outlines, in simplified form, part of the checkpoint that controls the initiation of DNA replication, called S phase. A protein kinase called ATM is associated with the genome. If the DNA contains a double-stranded break, the resulting change in the conformation of the chromatin activates ATM. Upon activation, one subunit of the activated ATM dimer dissociates and initiates a series, or cascade, of protein phosphorylation-dephosphorylation events mediated by the CHK1 and CHK2 protein kinases, the Cdc25 protein phosphatase, and finally a complex between a cyclin and a cyclin-dependent protein kinase, or Cdk. Activation of the Cdk-cyclin complex blocks the G_1 to S transition, thus preventing the replication of damaged DNA. Failure at this checkpoint can lead to mutations in DNA that may lead to cancer or other diseases. Each step in the cascade provides a conduit for monitoring additional indicators of cell status prior to entering S phase.

SUMMARY

- Homeostasis involves maintaining a relatively constant intracellular and intra-organ environment despite wide fluctuations in the external environment. This is achieved via appropriate changes in the rates of biochemical reactions in response to physiologic need.
- The substrates for most enzymes are usually present at a concentration close to their K_m . This facilitates passive control of the rates of product formation in response to changes in levels of metabolic intermediates.
- Active control of metabolite flux involves changes in the concentration, catalytic activity, or both of an enzyme that catalyzes a committed, rate-limiting reaction.
- Selective proteolysis of catalytically inactive proenzymes initiates conformational changes that form the active site. Secretion as an inactive proenzyme facilitates rapid mobilization of activity in response to injury or physiologic need and may protect the tissue of origin (eg, autodigestion by proteases).
- Binding of metabolites and second messengers to sites distinct from the catalytic sites of enzymes triggers conformational changes that alter V_{max} or K_m .

- Phosphorylation by protein kinases of specific seryl, threonyl, or tyrosyl residues—and subsequent dephosphorylation by protein phosphatases—regulates the activity of many human enzymes.
- The protein kinases and phosphatases that participate in regulatory cascades responsive to hormonal or second messenger signals form regulatory networks that can process and integrate complex environmental information to produce an appropriate and comprehensive cellular response.
- Numerous metabolic enzymes are modified by the acetylation-deacetylation of lysine residues. The degree of acetylation of these proteins is thought to be modulated by the availability of acetyl-CoA, the acetyl donor substrate for lysine acetyltransferases, and NAD^+ , a substrate for the sirtuin deacetylases.
- The capacity of protein kinases, protein phosphatases, lysine acetylases, and lysine deacetylases to target both multiple proteins and multiple sites on proteins is key to the formation of integrated regulatory networks.

REFERENCES

- Ciechanover A, Schwartz AL: The ubiquitin system: pathogenesis of human diseases and drug targeting. *Biochim Biophys Acta* 2004;1695:3.
- Elgin SC, Reuter G: In: Allis CD, Jenuwein T, Reinberg D, et al (editors): *Epigenetics*, Cold Spring Harbor Laboratory Press, 2007.
- Guan K-L, Xiong Y: Regulation of intermediary metabolism by protein acetylation. *Trends Biochem Sci* 2011;36:108.
- Johnson LN, Lewis RJ: Structural basis for control by phosphorylation. *Chem Rev* 2001;101:2209.
- Muoio DM, Newgard CB: Obesity-related derangements in metabolic regulation. *Annu Rev Biochem* 2006;75:403.
- Stieglitz K, Stec B, Baker DP, et al: Monitoring the transition from the T to the R state in *E coli* aspartate transcarbamoylase by x-ray crystallography: crystal structures of the E50A mutant enzyme in four distinct allosteric states. *J Mol Biol* 2004;341:853.
- Tu BP, Kudlicki A, Rowicka M, et al: Logic of the yeast metabolic cycle: temporal compartmentalization of cellular processes. *Science* 2005;310:1152.
- Walsh CT: *Posttranslational Modification of Proteins. Expanding Nature's Inventory*, Roberts and Company Publishers, 2006.

Bioinformatics & Computational Biology

Peter J. Kennelly, PhD & Victor W. Rodwell, PhD

OBJECTIVES

After studying this chapter, you should be able to:

- Describe the distinguishing features of genomics, proteomics, and bioinformatics.
- Recognize the potential and challenges presented by genome-guided personalized medicine.
- Summarize the principal features and medical relevance of the ENCODE project.
- Describe the functions served by HapMap, *Entrez Gene*, and the dbGAP databases.
- Explain how BLAST and deciphering of the folding code assist scientists in the elucidation of the form and function of unknown or hypothetical proteins.
- Describe the major features of computer-aided drug design and discovery.
- Describe possible future applications of computational models of individual pathways and pathway networks.
- Outline the possible medical utility of “virtual cells.”

BIOMEDICAL IMPORTANCE

The first scientific models of pathogenesis, such as Louis Pasteur’s seminal germ theory of disease, were binary in nature: each disease possessed a single, definable causal agent. Malaria was caused by amoeba of the genus *Plasmodium*, tuberculosis by the bacterium *Mycobacterium tuberculosis*, sickle cell disease by a mutation in a gene encoding one of the subunits of hemoglobin, poliomyelitis by poliovirus, and scurvy by a deficiency in ascorbic acid. The strategy for treating or preventing disease thus could be reduced to a straightforward process of tracing the causal agent, and then devising some means of eliminating it, neutralizing its effects, or blocking its route of transmission.

While simple models proved effective for understanding and treating a wide range of nutritional, infectious, and genetic diseases, efforts to identify discrete causal agents for diseases such as cancer, heart disease, obesity, type II diabetes, and Alzheimer’s disease have proved unavailing. The origins and progression of these latter diseases are **multifactorial** in nature, the product of the complex interplay between each individual’s genetic makeup, other inherited or **epigenetic** factors, and environmental factors such as diet, lifestyle, toxins,

viruses, or bacteria. Unraveling these multidimensionally complex and subtly amorphous biomedical puzzles demands the acquisition and analysis of data on a scale that lies beyond the ability of human beings to collect, organize, and review unaided.

The term **bioinformatics** refers to the application of computer and robotics technology to automate the collection, retrieval, and analysis of scientific data on a mass scale. A major objective of many bioinformaticists is to develop algorithms capable of reliably predicting the three-dimensional structures and functional properties of the roughly one-third of all genetically-encoded proteins currently categorized as “unknown” or “hypothetical.” Another is to use information technology to increase the rapidity and effectiveness with which doctors can diagnose and treat patients by providing physicians with immediate access to critical information such as medical histories and drug interaction data. The goal of **computational biology** is to allow researchers to perform experiments *in silico* on digital virtual models of molecules, cells, organs, and organisms. These virtual models hold great promise for enhancing the pace and extending the scope of biomedical research by freeing scientists from the inherent material, economic, labor, temporal, and ethical constraints of the clinic and laboratory.

GENOMICS: AN INFORMATION AVALANCHE

Physicians and scientists have long understood that the genome, the complete complement of genetic information of a living organism, represented a rich source of information concerning topics ranging from basic metabolism to evolution to aging. However, for many years the massive size of the human genome, 3×10^9 nucleotide base pairs, rendered global analysis beyond the reach of the technology available for the acquisition and analysis of DNA sequence information. In 1990, the United States launched a multibillion dollar effort, the **Human Genome Project**, for the express purpose of developing the automated **high-throughput** techniques, instrumentation, and data mining software necessary to determine the entire DNA sequence of the *Homo sapiens* genome.

Completion of the first human genome project required 10 years and hundreds of millions of dollars. However, the advent of “next generation” sequencing technologies has since dramatically reduced the time and cost required. Today, the cost of determining an individual’s genome sequence is less than \$10,000. As a consequence, scientists are now analyzing and comparing DNA sequence data across large sample populations. In addition, commercial services have emerged where individuals who possess sufficient funds can have their own genome sequence determined. As prices continue to drop toward the industry’s stated target of \$1000 per sample, the number of persons seeking personalized medical advice and care based upon the physiological, medical, and hereditary information revealed by their genome will grow at an exponential rate.

The Human Genome Project

The successful completion of the Human Genome Project (HGP) represents the culmination of more than six decades of achievements in molecular biology, genetics, and biochemistry. The chronology below lists several of the milestone events that led to the determination of the entire sequence of the human genome.

- 1944—DNA is shown to be the hereditary material
- 1953—Concept of the double helix is posited
- 1966—The genetic code is solved
- 1972—Recombinant DNA technology is developed
- 1977—Practical DNA sequencing technology emerges
- 1983—The gene for Huntington disease is mapped
- 1985—The polymerase chain reaction (PCR) is invented
- 1986—DNA sequencing becomes automated
- 1986—The gene for Duchenne muscular dystrophy is identified
- 1989—The gene for cystic fibrosis is identified
- 1990—The Human Genome Project is launched in the United States
- 1994—Human genetic mapping is completed
- 1996—The first human gene map is established

- 1999—The single nucleotide polymorphism initiative is started
- 1999—The first sequence of a human chromosome, number 22, is completed
- 2000—“First draft” of the human genome is completed
- 2003—Sequencing of the first human genome is completed
- 2007—Commercial firms offer personal genome sequencing services
- 2008—Scientists embark on the sequencing of 1000 individual genomes to determine degree of genetic diversity in humans
- 2010—The genome of Neanderthal man is completed
- 2013—The first integrated map of genetic variations across 1092 individuals from fourteen populations is published

Today, the number of eukaryotic, prokaryotic, and archaeal organisms whose genomes have been sequenced numbers in the many hundreds. This collection includes upwards of forty mammalian genomes, such as those for one or more species of chicken, cat, dog, elephant, rat, rabbit, lion, tiger, leopard, pig, horse, chimpanzee, gorilla, orangutan, woolly mammoth, opossum, duck-billed platypus, bottle-nosed dolphin, bat, panda, koala, wallaby, and Tasmanian devil. Comparisons with the Neanderthal genome suggest that up to 2% of the DNA in the genome of present-day humans originated in Neanderthals or in Neanderthal ancestors, although the fraction is significantly lower in individuals of African descent. The DNA sequences for the genomes of more than one thousand *Homo sapiens* have been determined. Ready access to a growing library of genome sequences from organisms spanning all three phylogenetic domains and to the powerful algorithms requisite for manipulating the data derived from these sequences has emerged as a transformative influence on research in biology, microbiology, pharmacology, evolution, and biochemistry.

Genomes and Medicine

There are several ways in which the genomics revolution will impact medicine in the 21st century. The most profound of these will be the ability to mine an individual’s genome sequence for indicators forecasting their susceptibility to specific diseases, sensitivity to potential allergens, and receptivity to specific pharmacologic interventions. Implementation of preventive measures, such as a tailored dietary regime, to prevent or ameliorate potential health problems long before symptoms become manifest should dramatically reduce the occurrence and impact, as well as the personal and societal cost, of numerous pathologies. Knowledge of a patient’s genome sequence also may eventually pave the way to using gene therapy to prevent, cure, or treat disease. The ability to diagnose and treat patients guided by knowledge of their genetic makeup, an approach popularly referred to as “designer medicine,” will render medicine safer and more effective.

Genomics will also facilitate the development of antibiotics and other drugs. By comparing the genomes of pathogenic and

nonpathogenic strains of a particular microorganism, genes likely to encode determinants of virulence can be highlighted by virtue of their presence in only the virulent strain. Similarly, comparison of the genomes of a pathogen with its host can identify genes unique to the former. Drugs targeting the protein products of the pathogen-specific genes should, in theory, produce little or no side effects for the infected host.

Exome Sequencing

“Exome sequencing” has emerged as an alternative to whole genome sequencing as a means for diagnosing rare or cryptic genetic diseases. The exome consists of those segments of DNA, called exons, that code for the amino acid sequences of proteins (see Chapter 36). Since exons comprise only about 1% of the human genome, the exome represents a much smaller and more tractable target than the complete genome. Comparison of exome sequences has identified genes harboring mutations responsible for a growing list of diseases that includes retinitis pigmentosa, Freeman-Sheldon syndrome, Sensenbrenner syndrome, Miller syndrome, Schinzel-Giedion syndrome, and Kabuki syndrome as well as variants of spinocerebellar ataxia, inflammatory bowel disease, osteogenesis imperfecta, Charcot-Marie-Tooth disease, mental retardation, and amyotrophic lateral sclerosis.

Potential Challenges of Designer Medicine

While genome-based “designer medicine” promises to be very effective, it also confronts humanity with profound challenges in the areas of ethics, law, and public policy. Who owns and controls access to this information? Can a life or health insurance company deny coverage to an individual based upon the risk factors inferred from their genome sequence? Does a prospective employer have the right to know a current or potential employee’s genetic makeup? Do prospective spouses have the right to know their fiancées’ genetic risk factors? Where does the boundary lie between the medical and elective applications of gene therapy? Other issues include standards for determining the degree to which research data concerning specific genetic polymorphisms can be safely and reliably interpreted and acted upon. For example, what predictions should be made if a patient manifests a mutation in a gene where mutations of *other* nucleotides have been shown to have deleterious effects? What if the only available data regarding the mutation of a particular gene is based on observations generated in a model organism such as *Drosophila melanogaster* (fruit fly), *Caenorhabditis elegans* (nematode), or mice? Ironically, the resolution of these issues may prove a more lengthy and laborious process than did the determination of the first human genome sequence.

BIOINFORMATICS

Bioinformatics exploits the formidable information storage and processing capabilities of the computer to develop tools for the collection, collation, retrieval, and analysis of biologic

data on a mass scale. That many bioinformatic resources (see below) can be accessed via the Internet provides them with global reach and impact. The central objective of a typical bioinformatics project is to assemble all of the available information relevant to a particular topic in a single location, often referred to as a **library** or **database**, in a uniform format that renders the data amenable to manipulation and analysis by computer algorithms.

Bioinformatic Databases

The size and capabilities of bioinformatic databases vary widely depending upon the scope and nature of their objectives. The PubMed database compiles citations for all articles published in thousands of journals devoted to biomedical and biological research. Currently, PubMed contains over 24 million citations. By contrast, the RNA Helicase Database confines itself to the sequence, structure, and biochemical and cellular function of a single family of enzymes, the RNA helicases.

Challenges of Database Construction

The construction of a comprehensive and user-friendly database presents many challenges. First, biomedical information comes in a wide variety of forms. For example, the coding information in a genome, although voluminous, is composed of simple linear sequences of four nucleotide bases. While the number of amino acid residues that define a protein’s primary structure is minute relative to the number of base pairs in a genome, a description of a protein’s x-ray structure requires that the location of each atom be specified in three-dimensional space. Second, the designer must anticipate the manner in which users may wish to search or analyze the information within a database, and must devise algorithms for coping with these variables. Even the seemingly simple task of searching a gene database commonly employs, alone or in various combinations, criteria as diverse as the name of the gene, the name of the protein that it encodes, the biologic function of the gene product, a nucleotide sequence within the gene, a sequence of amino acids within the protein it encodes, the organism in which it is present, or the name of the investigator who determined the sequence of that gene.

EPIDEMIOLOGY ESTABLISHED THE MEDICAL POTENTIAL OF INFORMATION PROCESSING

The power of basic biomedical research resides in the laboratory scientist’s ability to manipulate homogenous, well-defined research targets under carefully controlled circumstances. The ability to independently vary the qualitative and quantitative characteristics of both target and input variables permits cause-effect relationships to be inferred in a direct

and reliable manner. These advantages are obtained, however, by working with purified biomolecules or by employing cultured cell lines or “model” organisms such as mice as stand-ins for the human patients that represent the ultimate targets for, and beneficiaries of, this research. Laboratory animals do not always react as do *Homo sapiens*, nor can a dish of cultured fibroblast, kidney, or other cells replicate the incredible complexity of a human being.

Meticulous observation of real world behavior has long proven to be a source of important biomedical insights. Hippocrates, for example, noted that while certain **epidemic** diseases appeared in a sporadic fashion, **endemic** diseases such as malaria exhibited clear association with particular locations, age groups, etc. **Epidemiology** refers to the branch of the biomedical sciences that employs bioinformatic approaches to extend our ability and increase the accuracy with which we can identify factors that contribute to or detract from human health through the study of real world populations.

Early Epidemiology of Cholera

One of the first recorded epidemiological studies, conducted by Dr. John Snow, employed simple geospatial analysis to track the source of a cholera outbreak. Epidemics of cholera, typhus, and other infectious diseases were relatively common in the crowded, unsanitary conditions of nineteenth century London. By mapping the locations of the victims’ residences, Snow was able to trace the source of the contagion to the contamination of one of the public pumps that supplied citizens with their drinking water (**Figure 10–1**). Unfortunately, the limited capacity of hand calculations or graphing rendered the success of analyses such as Snow’s critically dependent upon the choice of the working hypothesis used to select the variables to be measured and processed. Thus, while 19th century Londoners also widely recognized that haberdashers were particularly prone to display erratic and irrational behavior (eg, “as Mad as a Hatter”), nearly a century would pass before the cause was traced to the mercury compounds used to prepare the felt from which the hats were constructed.



FIGURE 10–1 This version of the map drawn by Dr. John Snow compares the location of the residences of victims of an 1854 London cholera epidemic (Dots) with the locations of the pumps that supplied their drinking water (X's). Contaminated water from the pump on Broad Street, lying roughly in the center of the cluster of victims, proved to be the source of the epidemic in this neighborhood.

Impact of Bioinformatics on Epidemiological Analysis

As the process of data analysis has become automated, the sophistication and success rate of epidemiological analyses have risen accordingly. The Framingham Heart Study, which has tracked the personal and medical histories of more than 5000 individuals living in and around Framingham, MA, and their descendants for more than six decades, has been instrumental in the identification of risk factors for cardiovascular disease. Today, complex computer algorithms enable researchers to assess the influence of a broad range of health-related parameters when tracking the identity and source or reconstructing the transmission of a disease or condition: height, weight, age, gender; body mass index; diet; ethnicity; medical history; profession; drug, alcohol, or tobacco use; exercise; blood pressure; habitat; marital status; blood type; serum cholesterol level; areas of residency and travel; etc. Equally important, modern bioinformatics may soon enable epidemiologists to dissect the identities and interactions of the multiple factors underlying complex diseases such as cancer, sudden infant death syndrome, Alzheimer's disease or ebola.

The continued accumulation of genome and exome sequences from individual human beings has introduced a powerful new dimension to the host of biological, environmental, and behavioral factors to be compared and contrasted with each person's medical history. One of the first fruits of these studies has been the identification of genes responsible for a few of the over 3000 known or suspected Mendelian disorders whose causal genetic abnormalities have yet to be traced. The ability to evaluate contributions of and the interactions among an individual's genetic makeup, behavior, environment, diet, and lifestyle holds the promise of eventually revealing the answers to the age-old question of why some persons exhibit greater vitality, stamina, longevity, and resistance to disease than others—in other words, the root sources of health and wellness.

BIOINFORMATIC AND GENOMIC RESOURCES

The large collection of databases that have been developed for the assembly, annotation, analysis and distribution of biological and biomedical data reflects the breadth and variety of contemporary molecular, biochemical, epidemiological, and clinical research. Discussed below are UniProtKB, GenBank, and the Protein Database (PDB), mutually complementary databases that address aspects of macromolecular structure.

UniProtKB

The UniProt Knowledgebase, UniProtKB, is jointly sponsored by the Swiss Institute of Bioinformatics and the European Bioinformatics Institute. UniProtKB's stated objective is "to provide the scientific community with a comprehensive,

high-quality and freely accessible resource of protein sequence and structural information". It is organized into two sections. Swiss-Prot contains entries whose assigned functions, domain structure, post-translational modifications, etc have been verified by manual curation, largely through searches for empirical data from the scientific literature and expert examination of multiple sequence comparisons. TrEMBL, on the other hand, contains empirically determined and genome-derived protein sequences whose potential functions have been assigned, or annotated, automatically—solely on the basis of computer algorithms. Thus, while TrEMBL currently includes more than 80 million entries, Swiss-Prot contains slightly more than 500,000.

GenBank

The goal of GenBank, the genetic sequence database of the National Institutes of Health (NIH), is to collect and store all known biological nucleotide sequences and their translations in a searchable form. Established in 1979 by Walter Goad of Los Alamos National Laboratory, GenBank currently is maintained by the National Center for Biotechnology Information at the NIH. GenBank constitutes one of the cornerstones of the International Sequence Database Collaboration, a consortium that includes the DNA Database of Japan and the European Molecular Biology Laboratory.

PDB

The RCSB Protein Data Base (PDB) is a repository of the three-dimensional structures of proteins, polynucleotides, and other biological macromolecules. The PDB presently contains over 95,000 three-dimensional structures for proteins, as well as proteins bound with substrates, substrate analogs, inhibitors, or other proteins. The user can rotate these structures freely in three-dimensional space, highlight specific amino acids, and select from a variety of formats such as space filling, ribbon, backbone, etc (see Chapters 5, 6, and below).

SNPs & Tagged SNPs

While the genome sequence of any two individuals is 99.9% identical, human DNA contains ~10 million sites where individuals differ by a single-nucleotide base. These sites are called **Single Nucleotide Polymorphisms** or **SNPs**. When sets of SNPs localized to the same chromosome are inherited together in blocks, the pattern of SNPs in each block is termed a **haplotype**. By comparing the haplotype distributions between groups of individuals that differ in some physiological characteristic, such as susceptibility to a disease, biomedical scientists can identify SNPs that are associated with specific phenotypic traits. This process can be facilitated by focusing on **Tag SNPs**, a subset of the SNPs in a given block sufficient to provide a unique marker for a given haplotype. Selected regions are then subject to more detailed study to identify the specific genetic variations that contribute to a specific disease or physiologic response.

HapMap

In 2002, scientists from the United States, Canada, China, Japan, Nigeria, and the United Kingdom launched the International **Haplotype Map (HapMap) Project**, a comprehensive effort to identify SNPs associated with common human diseases and differential responses to pharmaceuticals. The long-term goal of the project is to provide earlier and more accurate diagnosis of potential genetic risk factors that leads to improved prevention and more effective patient management. Knowledge of an individual's genetic profile will also be used to guide the selection of safer and more effective drugs or vaccines, a process termed **pharmacogenomics**. These genetic markers will also provide labels with which to identify and track specific genes as scientists seek to learn more about the critical processes of genetic inheritance and selection.

ENCODE

Identification of all the *functional elements* of the genome will vastly expand our understanding of the molecular events that underlie human development, health, and disease. To address this goal, the National Human Genome Research Institute (NHGRI) initiated the **ENCODE (Encyclopedia of DNA Elements) Project**. Based at the University of California at Santa Cruz, ENCODE is a collaborative effort that combines laboratory and computational approaches to identify every functional element in the human genome. Consortium investigators with diverse backgrounds and expertise collaborate in the development and evaluation of new high-throughput techniques, technologies, and strategies to address current deficiencies in our ability to identify functional elements.

As of 2013, ENCODE has analyzed 147 different human cell types using a variety of methods to identify, or **annotate**, function. These include mapping sites of DNA methylation as a putative indicator of regulatory control, assessing local histone methylation and sensitivity to hydrolysis by deoxyribonucleases as indicators of transcriptional activity (see Chapter 35), and probing for transcription factor binding sites using a luciferase reporter system. On the basis of these circumstantial indicators, it has been estimated that roughly 80% of the human genome, including the bulk of the noncoding “junk” DNA, is functionally active in one or more cell types.

Entrez Gene

Entrez Gene, a database maintained by the National Center for Biotechnology Information (NCBI), provides a variety of information about individual human genes. The information includes the sequence of the genome in and around the gene, exon-intron boundaries, the sequence of the mRNA(s) produced from the gene, and any known phenotypes associated with a given mutation of the gene in question. *Entrez Gene* also lists, where known, the function of the encoded protein and the impact of known single-nucleotide polymorphisms within its coding region.

dbGAP

dbGAP, the **Database of Genotype and Phenotype**, is an NCBI database that complements *Entrez Gene*. dbGAP compiles the results of research into the links between specific genotypes and phenotypes. To protect the confidentiality of sensitive clinical data, the information contained in dbGAP is organized into open- and controlled-access sections. Access to sensitive data requires that the user apply for authorization to a Data Access Committee.

Additional Databases

Other databases dealing with human genetics and health include **OMIM**, Online Mendelian Inheritance in Man, **HGMD**, the Human Gene Mutation Database, the **Cancer Genome Atlas**, and **GeneCards**, which tries to collect all relevant information on a given gene from databases worldwide to create a single, comprehensive “card” for each.

COMPUTATIONAL BIOLOGY

The primary objective of **computational biology** is to develop computer models that apply physical, chemical, and biological principles to reproduce the behavior of biologic molecules and processes. Unlike bioinformatics, whose major focus is the collection and evaluation of existing data, computational biology is experimental and exploratory in nature. By performing virtual experiments and analyses “*in silico*,” meaning performed on a computer or through a computer simulation, computational biology aspires to accelerate the pace and efficiency of scientific discovery.

Computational biologists are attempting to develop predictive models that will (1) permit the three-dimensional structure of a protein to be determined directly from its primary sequence, (2) infer the function of unknown proteins from their primary sequence or three dimensional structure, (3) screen for potential inhibitors of a protein *in silico*, and (4) construct virtual cells that reproduce the behavior and predict the responses of their living counterparts to pathogens, toxins, diet, and drugs. The creation of computer algorithms that accurately imitate the behavior of proteins, enzymes, cells, etc, promises to enhance the speed, efficiency, and the safety of biomedical research. Computational biology will also enable scientists to perform experiments *in silico* whose scope, hazard, or nature renders them inaccessible to, or inappropriate for, conventional laboratory or clinical venues.

IDENTIFICATION OF PROTEINS BY HOMOLOGY

One important method for the identification, also called **annotation**, of novel proteins and gene products is to compare their amino acid sequences with those of proteins whose functions or

Language	Word	Alignment
English	PHYSIOLOGICAL	P H Y S I O L O G I - C A L
French	PHYSIOLOGIQUE	P H Y S I O L O G I - Q U E
German	PHYSIOLOGISCH	P H Y S I O L O G I S C H
Dutch	FYSIOLOGISCH	F - Y S I O L O G I S C H
Spanish	FYSIOLOGICO	F - Y S I O L O G I - C O
Polish	FIZJOLOGICZNY	F - I Z J O L O G I - C Z N Y

FIGURE 10–2 Representation of a multiple sequence alignment. Languages evolve in a fashion that mimics that of genes and proteins. Shown is the English word “physiological” in several languages. The alignment demonstrates their conserved features. Identities with the English word are shown in dark red; linguistic similarities in dark blue. Multiple sequence alignment algorithms identify conserved nucleotide and amino acid letters in DNA, RNA, and polypeptides in an analogous fashion.

structures had been determined previously. Simply put, homology searches and multiple sequence comparisons operate on the principle that proteins that perform similar functions will share conserved domains or other sequence features or **motifs**, and vice versa (**Figure 10–2**). Of the many algorithms developed for this purpose, the most widely used are **BLAST** and its derivatives.

BLAST

BLAST (Basic Local Alignment Search Tool) and other sequence comparison/alignment algorithms trace their origins to the efforts of early molecular biologists to determine whether observed similarities in sequence among proteins that perform similar metabolic functions were indicative of progressive changes in a common ancestral protein. The major evolutionary question addressed was whether the similarities reflected (1) descent from a common ancestral protein (**divergent evolution**) or (2) the independent selection of a common mechanism for meeting some specific cellular need (**convergent evolution**), as would be anticipated if one particular solution was overwhelmingly superior to the alternatives. Calculation of the minimum number of nucleotide changes required to interconvert putative protein isoforms allows inferences to be drawn concerning whether or not the similarities and differences exhibit a pattern indicative of progressive change from a shared origin.

Over time, BLAST has evolved into a family of programs optimized to address specific needs and data sets. Thus, **blastp** compares an *amino acid* query sequence against a *protein* sequence database, **blastn** compares a *nucleotide* query sequence against a *nucleotide* sequence database, **blastx** compares a *nucleotide* query sequence translated in all reading frames against a *protein* sequence database to reveal potential translation products, **tblastn** compares a *protein* query sequence against a *nucleotide* sequence database dynamically translated in all six reading frames, and **tblastx** compares the six-frame translations of a *nucleotide* query sequence against the six-frame translations of a *nucleotide* sequence database. Unlike multiple sequence

alignment programs that rely on *global* alignments, **BLAST** algorithms emphasize regions of *local* alignment to detect relationships among sequences with only isolated regions of similarity. This approach provides speed and increased sensitivity for distant sequence relationships. Input or “query” sequences are broken into “words” (default size 11 for nucleotides, 3 for amino acids). Word hits to databases are then extended in both directions.

IDENTIFICATION OF “UNKNOWN” PROTEINS

A substantial portion, 30% to 50%, of the genes discovered by genome sequencing projects code for “unknown” or hypothetical polypeptides for which homologs of known function are lacking. Bioinformaticists are working to develop and refine tools to enable scientists to deduce the three-dimensional structure and function of cryptic proteins directly from their amino acid sequences. The ability to generate structures and infer function *in silico* promises to significantly accelerate protein identification and provide insight into the mechanism by which proteins fold. This knowledge will aid in understanding the underlying mechanisms of various protein folding diseases, and will assist molecular engineers to design new proteins to perform novel functions.

The Folding Code

Comparison of protein three-dimensional structures can reveal patterns that link specific primary sequence features to specific primary, secondary, and tertiary structures—sometimes called the folding code. The first algorithms used the frequency with which individual amino acids occurred in α helices, β sheets, turns, and loops to predict the number and location of these elements within the sequence of a polypeptide, known as its secondary structure topography. By extending this process, for example, by weighing the impact of hydrophobic interactions in the formation of the protein core, algorithms of remarkable predictive reliability are being developed. However, while current programs perform well in generating the conformations of proteins comprised of a single domain, projecting the likely structure of membrane proteins and those composed of multiple domains remains problematic.

Relating Three-Dimensional Structure to Function

Scientists also continue to search for recurring features of protein three-dimensional structure that correlate to specific physiologic functions such as binding of a particular substrate or other ligand. The space-filling representation of the enzyme HMG-CoA reductase and its complex with the drug

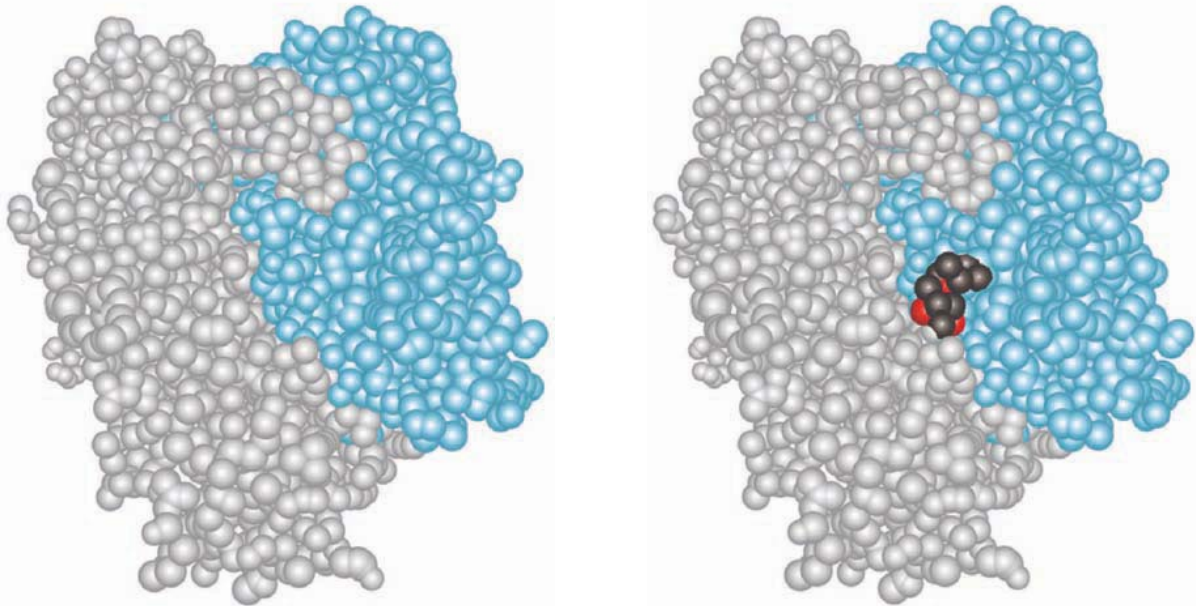

FIGURE 10-3 Shown are space-filling representations of the homodimeric HMG-CoA reductase from *Pseudomonas mevalonii* with (right) and without (left) the statin drug lovastatin bound. Each atom is represented by a sphere the size of its van der Waals' radius. The two polypeptide chains are colored gray and blue. The carbon atoms of lovastatin are colored black and the oxygen atoms red. Compare this model with the backbone representations of proteins shown in Chapters 5 and 6. (Adapted from Protein Data Bank ID no. 1t02.)

lovastatin (Figure 10-3) provides some perspective on the challenges inherent in identifying ligand-binding sites from scratch. Where a complete three-dimensional structure can be determined or predicted, the protein's surface can be scanned for the types of pockets and crevices indicative of likely binding sites for substrates, allosteric effectors, etc. by any one of a variety of methods such as tracing its surface with balls of a particular dimension (Figure 10-4). Surface maps generated with the program Graphical Representation and Analysis of Surface Properties, commonly referred to as **GRASP diagrams**, highlight the locations of neutral, negatively charged, and positively charged functional groups on a protein's surface (Figure 10-5) to infer a more detailed picture of the biomolecule that binds to or "docks" at that site. The predicted structure of the ligands that bind to an unknown protein, along with other structural characteristics and sequence motifs, can then provide scientists with the clues needed to make an "educated guess" regarding its biological function(s).

Enzyme Function Initiative

As of 2014, the UniProt database of protein sequences reportedly contains 84 million entries. Although impressive in number, the utility of this library of sequence information is seriously circumscribed by the lack of direct experimental evidence documenting the functional capabilities of all but a small portion of these proteins. Thus, in the vast majority of cases the projected functions of these proteins have been inferred by looking for structural homologs. While extrapolating function from form is theoretically sound, in many cases the closest sequence homolog is also a protein whose

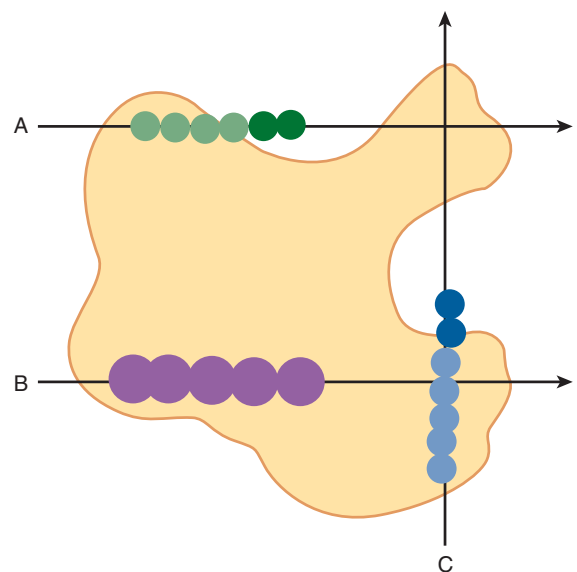

FIGURE 10-4 A simplified representation of a ligand site prediction program. Ligand site prediction programs such as POCKET, LIGSITE, or Pocket-Finder convert the three-dimensional structure of a protein into a set of coordinates for its component atoms. A two-dimensional slice of the space filled by these coordinates is presented as an irregularly shaped outline (pale orange). A round probe is then passed repeatedly through these coordinates along a series of lines paralleling each of the three coordinate axes (A, B, C). Lightly shaded circles represent positions of the probe where its radius overlaps one or more atoms in the Cartesian coordinate set. Darkly shaded circles represent positions where no protein atom coordinates fall within the probe's radius. In order to qualify as a pocket or crevice within the protein, and not just open space outside of it, the probe must eventually encounter protein atoms lying on the other side of the opening (C).

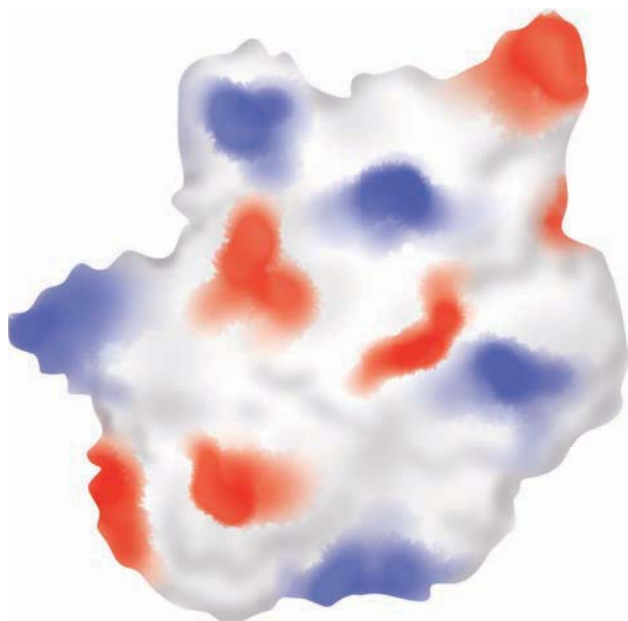

FIGURE 10-5 Representation of a GRASP diagram indicating the electrostatic topography of a protein. Shown is a space-filling representation of a hypothetical protein. Areas shaded in red indicate the presence of amino acid side chains or other moieties on the protein surface predicted to bear a negative charge at neutral pH. Blue indicates the presence of predicted positively charged groups. White denotes areas predicted to be electrostatically neutral.

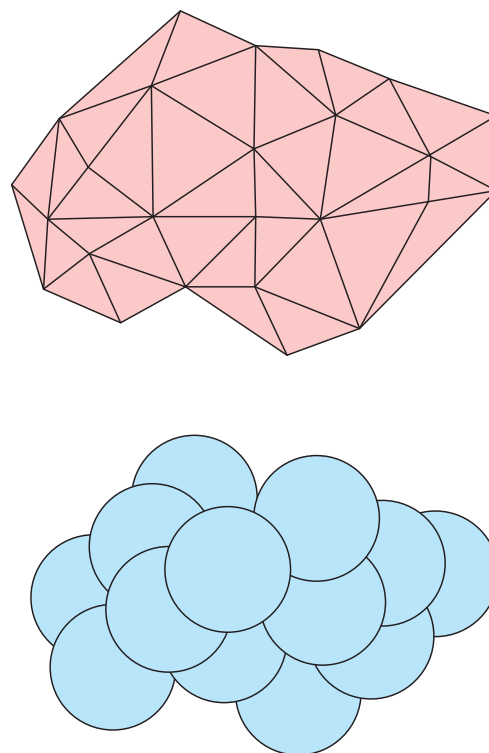

FIGURE 10-6 Simplified digital representations of the surface topography of a molecule using either triangular panels or an assembly of spheres.

function(s) has been inferred from a previous homolog. Hence, the relationship between a novel protein and one whose functional properties have been experimentally verified can be quite distant and error prone. In addition, many of the proteins whose sequences have been deduced from genome sequencing do not possess even a distant homolog of known function. Established in 2010, the objective of the Enzyme Function Initiative, a consortium of ≈ 80 scientists located at nine North American Academic Institutions, is to develop a new generation of more powerful and reliable bioinformatic and computational tools for predicting function from protein sequence and structure.

COMPUTER-AIDED DRUG DESIGN

The objective of **Computer-Aided Drug Design (CADD)** is to develop *in silico* methods for identifying potential drug targets in order to dramatically reduce the effort invested in costly and time-intensive laboratory screening approaches. While this cannot eliminate the need for empirical testing and analysis, it can narrow its focus several hundred- or thousand-fold to a handful of promising “lead compounds”.

Screening Virtual Libraries

For proteins of known three-dimensional structure, molecular-docking approaches employ programs that attempt to fit a series of potential ligand “pegs” into a designated binding site

or “hole” on a protein template. To identify optimum ligands, docking programs must account for matching shapes as well as the presence and position of complementary hydrophobic, hydrophilic, and charged groups. The first step in this process is to construct a digital representation of the protein that can be manipulated computationally without exceeding the host computer’s memory and information processing capacity. Methods for accomplishing this include representing protein as a collection of spheres or by dividing its surface into geometric segments (**Figure 10-6**). Each surface is then assigned mathematical parameters that summarize the steric and physicochemical characteristics of the corresponding portion of the protein. The computer program then attempts to dock similar digital representation of potential ligands, mathematically calculating the degree of fit by entering the parameters into a formula called a **potential energy function** that integrates the attractive and repulsive interactions between them.

An alternative strategy to screening a digitized library of known compounds is to use the target site on the protein as a template to build a complementary ligand *de novo*. In this process the digitized cavity is first filled with spheres to define the steric space available to the ligand. Next, chemical functional groups projected to favorably interact with the adjacent charged, hydrogen bonding, and other functional groups on the protein’s surface are positioned at key points within the steric model. Lastly, the computer searches for chemically plausible ways to link these key groups to generate a candidate ligand (**Figure 10-7**).

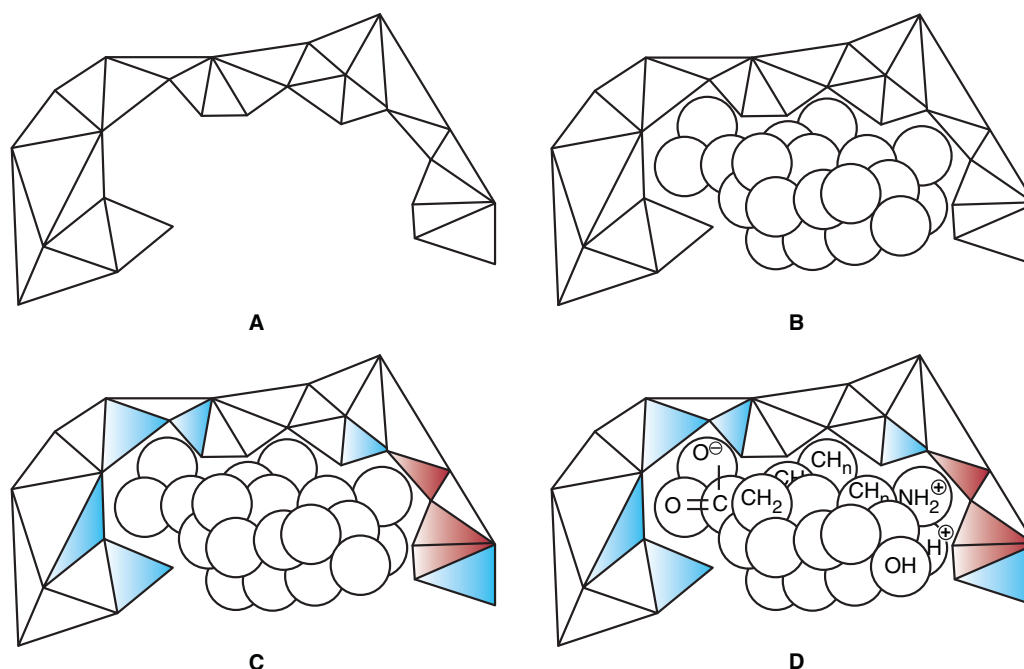

FIGURE 10-7 Reverse-engineering a ligand *in silico*. Panel A shows a digital representation of a prospective ligand-binding site. In panel B, the binding site is filled by spherical units defining the steric limits for a prospective ligand. In Panel C, basic physicochemical features of the binding site are represented using white for hydrophobic, red for negatively charged, blue for positively charged, and green for uncharged hydrophilic surfaces. Panel D shows the positioning of proposed matching functional groups for a ligand, such as carboxylates, amino groups, and hydrocarbon moieties [CH_n]. The process is completed by inserting additional atoms and bonds to link the key groups together to form a single molecule.

The binding affinities of the inhibitors selected on the basis of early docking studies were disappointing. One contributing factor was the difficulty in assigning and weighing the steric, electrostatic, and hydrogen bonding interactions used in the digital representations of ligands and proteins. The second arose from the rigid nature of first generation models, which rendered them incapable of replicating the conformational changes that occur in ligand and protein as a consequence of binding and catalysis, a phenomenon referred to as “induced fit” (see Chapter 7). However, imbuing digital models of proteins and ligands with conformational flexibility, while technically feasible, requires massive computing power. Hybrid approaches have thus evolved that employ a set, or ensemble, of templates representing slightly different conformations of the protein (Figure 10-8) and either ensembles of ligand conformers (Figure 10-9) or ligands in which only a few select bonds are permitted to rotate freely. Once the set of potential ligands has been narrowed, more sophisticated docking analyses can be undertaken to identify high-affinity ligands able to interact

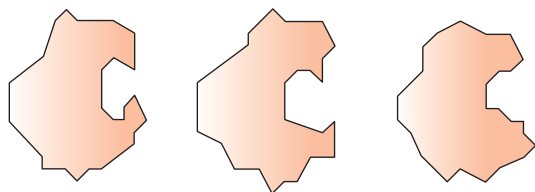

FIGURE 10-8 Two-dimensional representation of a set of conformers of a protein. Notice how the shape of the binding site changes.

with a given protein target across its spectrum of conformational states. The development of cloud computing offers one potential avenue for expanding the computational capacity available for performing CADD.

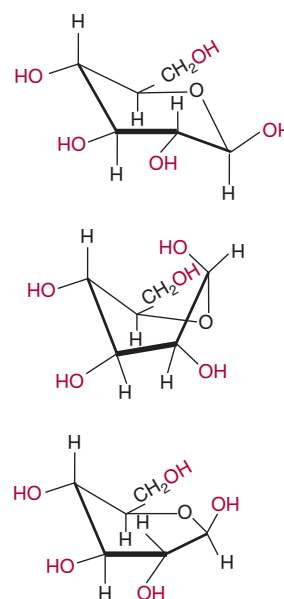

FIGURE 10-9 Conformers of a simple ligand. Shown are three of the many different conformations of glucose, commonly referred to as chair (top), twist boat (middle), and half chair (bottom). Note the differences not only in shape and compactness but also in the position of the hydroxyl groups, potential participants in hydrogen bonds, as highlighted in red.

Quantitative Structure-Activity Relationships

If no structural template is available for the protein of interest, computer programs can be used to assist the search for high-affinity inhibitors by calculating and projecting **quantitative structure-activity relationships (QSARs)**. In this process, empirical data describing key properties of trial compounds, such as K_i , rate of absorption, rate of metabolism, or toxic threshold are plotted as a function of a digital representation of the steric, electrostatic, and other features of the test molecules. Regression or neural network analysis of the resulting multidimensional matrix then is applied to identify molecular features that correlate well with desired biologic properties. This information can then be used to search databases of chemical compounds to identify those which possess the most promising combination of positive versus negative features.

SYSTEMS BIOLOGY & VIRTUAL CELLS

Systems Biology Aims to Construct Circuit Diagrams That Model Metabolism

What if a scientist could detect, in a few moments, the effect of inhibiting a particular enzyme, of replacing or inactivating a particular gene, the response of a muscle cell to insulin, the proliferation of a cancer cell, or the production of beta amyloid by entering the appropriate query into a computer? What if they could perform experiments on a major pathogen, such as Ebola, using a completely safe virtual virus? The goal of **systems biology** is to construct the molecular equivalent of circuit diagrams that faithfully depict the components of a particular functional unit and the interactions between them in logical or mathematical terms. These functional units can range in size and complexity from the enzymes and metabolites within a biosynthetic pathway to the network of proteins that controls the cell division cycle to, ultimately, entire cells, organs, and organisms. These models can then be used to perform “virtual” experiments that can enhance the speed and efficiency of empirical investigations by identifying the most promising lines of investigation and by assisting in the evaluation of results. The ability to conduct virtual experiments significantly extends the reach of the investigator, within the limits of the accuracy of the model, beyond the reach of current empirical technology.

Already, significant progress is being made. By constructing virtual molecular networks, scientists have been able to determine how cyanobacteria assemble a reliable circadian clock using only four proteins. Models of the T-cell receptor signaling pathway have revealed how its molecular circuitry has been arranged to produce switch-like responses upon stimulation by agonist peptide-major histocompatibility complexes (MHC) on an antigen-presenting cell. Scientists can use the gaps encountered in modeling molecular and cellular systems to guide the

identification and annotation of the remaining protein pieces, in the same way that someone who solves a jigsaw puzzle surveys the remaining pieces for matches to the gaps in the puzzle. This reverse engineering approach has been successfully used to define the function of type II glycerate 2-kinases in bacteria and to identify “cryptic” folate synthesis and transport genes in plants.

Virtual Cells

Recently, scientists have been able to successfully create a functional virtual metabolic network composed of nearly two hundred proteins—an important step toward the creation of a **virtual cell**. The “holy grail” of systems biologists is to replicate the behavior of living human cells *in silico*. The potential benefits of such virtual cells are enormous. Not only will they permit promising sites for therapeutic intervention to be rapidly identified, but they can provide advanced warning of targets for which pharmacologic intervention would generate deleterious side effects. The ability to conduct fast, economical toxicological screening of materials ranging from herbicides to cosmetics will benefit human health. Virtual cells can also aid in diagnosis. By manipulating a virtual cell to reproduce the metabolic profile of a patient, underlying genetic abnormalities may be revealed. The interplay of the various environmental, dietary, and genetic factors that contribute to multifactorial diseases such as cancer can be systematically analyzed. Preliminary trials of potential gene therapies can be assessed safely and rapidly *in silico*.

The duplication of a living cell *in silico* represents an extremely formidable undertaking. Not only must the virtual cell possess all of the proteins and metabolites for the type of cell to be modeled (eg, from brain, liver, nerve, muscle, or adipose), but these must be present in the appropriate concentration and subcellular location. The model must also account for the functional dynamics of its components, binding affinities, catalytic efficiency, covalent modifications, etc. To render a virtual cell capable of dividing or differentiating will entail a further quantum leap in complexity and sophistication.

Molecular Interaction Maps Employ Symbolic Logic

The models constructed by systems biologists can take a variety of forms depending upon the uses for which they are intended and the data available to guide their construction. If one wishes to model the flux of metabolites through an anabolic or catabolic pathway, it is not enough to know the identities and the reactants involved in each enzyme-catalyzed reaction. To obtain mathematically precise values, it is necessary to know the concentrations of the metabolites in question, the quantity of each enzyme present, and their catalytic parameters.

For most users, it is sufficient that a model describe and predict the qualitative nature of the interactions between components. Does an allosteric ligand activate or inhibit the enzyme? Does dissociation of a protein complex lead to the degradation of one or more of its components? For these purposes, a set of symbols depicting the symbolic logic of these

interactions was needed. Early representations frequently used the symbols previously developed for constructing flow charts used for computer programming or for electronic circuits (Figure 10–10, top). Ultimately, however, systems biologists

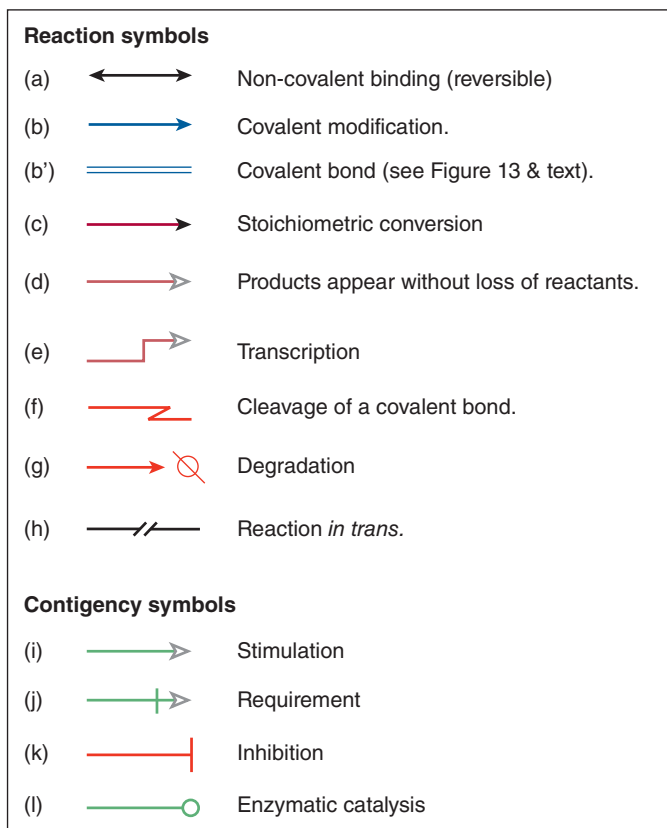
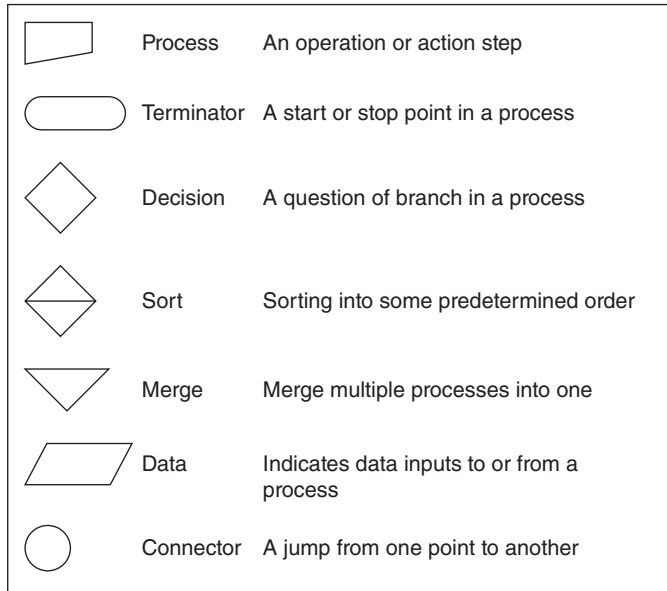

FIGURE 10–10 Symbols used to construct molecular circuit diagrams in systems biology. (Top) Sample flowchart symbols. (Bottom) Graphical symbols for molecular interaction maps (Adapted from Kohn KW, et al: Molecular interaction maps of bioregulatory networks: a general rubric for systems biology. *Mol Biol Cell* 2006;17:1.)

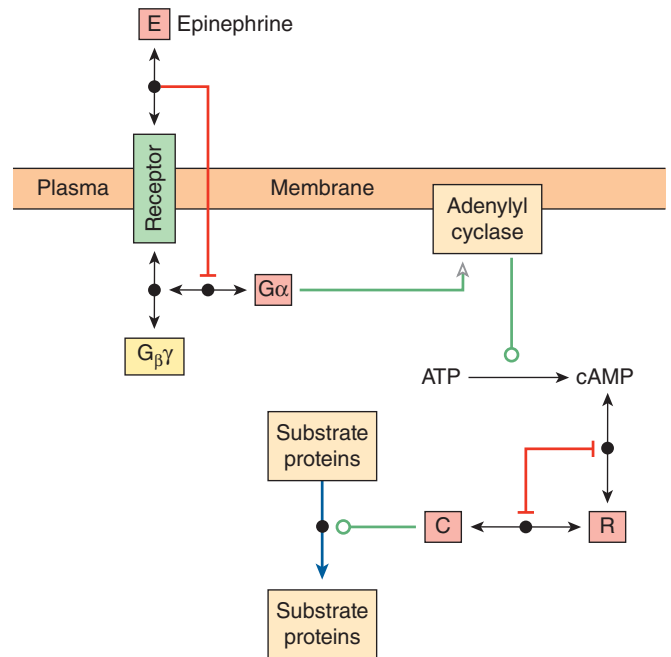

FIGURE 10–11 Representation of a molecular interaction network (MIN) depicting a signal transduction cascade leading to the phosphorylation of substrate proteins by the catalytic subunit, C, of the cyclic AMP-dependent protein kinase in response to epinephrine. Proteins are depicted as rectangles or squares. Double headed arrows indicate the formation of a non-covalent complex denoted by dot at the midpoint of the arrow. Red lines with T-shaped heads indicate inhibitory interaction. A green arrow with hollow head indicates a stimulatory interaction. Green line with open circle at end indicates catalysis. Blue arrow with P indicates covalent modification by phosphorylation. (Symbols adapted from Kohn KW, et al: Molecular interaction maps of bioregulatory networks: a general rubric for systems biology. *Mol Biol Cell* 2006;17:1.)

designed dedicated symbols (Figure 10–10, bottom) to depict these molecular circuit diagrams, more commonly referred to as **Molecular Interaction Maps (MIM)**, an example of which is shown in Figure 10–11. Unfortunately, as is the case with enzyme nomenclature (see Chapter 7) a consistent, universal set of symbols has yet to emerge.

CONCLUSION

The rapidly evolving fields of bioinformatics and computational biology hold unparalleled promise for the future of both medicine and basic biology. Some applications are at present perceived clearly, others dimly, while yet others remain unimagined. A major objective of computational biologists is to develop computational tools that will enhance the efficiency, effectiveness, and speed of drug development. Epidemiologists employ computers to extract patterns within a human population indicative of specific causes of and contributors to both disease and wellness. There seems little doubt that their impact on medical practice in the 21st century will equal or surpass that of the discovery of bacterial pathogenesis in the 19th century.

SUMMARY

- Genomics has yielded a massive quantity of information of great potential value to scientists and physicians.
- Genomics will be the catalyst for the development and spread of personalized medicine wherein diagnosis and treatment will be guided by knowledge of a patient's individual DNA sequence.
- Bioinformatics involves the design of computer algorithms and construction of databases that enable biomedical scientists to collect, access, and analyze the growing avalanche of biomedical data.
- The objective of epidemiology is to extract medical insights from the behavior of heterogeneous human populations by the application of sophisticated statistical tools.
- Major challenges in the construction of user-friendly databases include devising means for storing and organizing complex data that accommodate a wide range of potential search criteria.
- The goal of the Encode Project is to identify all the functional elements within the human genome.
- The HapMap, *Entrez Gene*, and dbGAP databases contain data concerning the relation of genetic mutations to pathological conditions.
- Genomics has uncovered the sequences of many thousands of proteins for which data regarding their structure and function are unavailable.
- BLAST is used to identify unknown proteins and genes by searching for sequence homologs of known function.
- Computational biologists are working to develop programs that predict the three-dimensional structure of unknown proteins directly from their primary sequence by deciphering the folding code.
- Computer-aided drug design speeds drug discovery by docking potential inhibitors to selected protein targets *in silico*.
- Computational biologists seek to enhance the speed and scope of biomedical research by constructing digital representations of proteins, pathways, and cells that will enable scientists to perform virtual experiments *in silico*.
- The ultimate goal of computational biologists is to create virtual cells, organs, and organisms that can be used to more safely and efficiently diagnose and treat diseases, particularly those of a multifactorial nature.
- Systems biologists commonly construct schematic representations known as molecular interaction maps in which symbolic logic is employed to illustrate the relationships between the components making up a pathway or some other functional unit.

REFERENCES

- Altschul SF, Gish W, Miller W, et al: Basic local alignment search tool. *J Mol Biol* 1990;215:403.
- Bamshad MJ, Ng SB, Bigham AW, et al: Exome sequencing as a tool for Mendelian gene discovery. *Nature Rev Genetics* 2011;12:745.
- Bromberg Y: Building a genome analysis pipeline to predict gene risk and prevent disease. *J Mol Biol* 2013;425:3993.
- Couzin J: The HapMap gold rush: researchers mine a rich deposit. *Science* 2006;312:1131.
- Cravatt BF, Wright AT, Kozarich JW: Activity-based protein profiling: from enzyme chemistry to proteomic chemistry. *Annu Rev Biochem* 2008;77:383.
- Dark MJ: Whole genome sequencing in bacteriology: state of the art. *Infect Drug Resist* 2013;6:115.
- Ekins S, Mestres J, Testa B: *In silico* pharmacology for drug discovery: methods for virtual ligand screening and profiling. *Br J Pharmacol* 2007;152:9.
- Ekins S, Mestres J, Testa B: *In silico* pharmacology for drug discovery: applications to targets and beyond. *Br J Pharmacol* 2007;152:21.
- Gibson DG, Glass JL, Lartigue C, et al: Creation of a bacterial cell controlled by a chemically synthesized genome. *Science* 2010;329:52.
- Guha R: On exploring structure-activity relationships. *Methods Mol Biol* 2013;993:81.
- Kaiser J: Affordable "exomes" fill gaps in a catalog of rare diseases. *Science* 2010;330:903.
- Kohn KW, Aladjem MI, Weinstein JN, et al: Molecular interaction maps of bioregulatory networks: a general rubric for systems biology. *Mol Biol Cell* 2006;17:1.
- Laurie ATR, Jackson RM: Methods for prediction of protein-ligand binding sites for structure-based drug design and virtual ligand screening. *Curr Prot Peptide Sci* 2006;7:395.
- McInnes C: Virtual screening strategies in drug discovery. *Curr Opin Cell Biol* 2007;11:494.
- Mohamed S, Syed B: Commercial prospects for genomic sequencing technologies. *Nature Rev Drug Disc* 2013;12:341.
- Oppenheimer GM: Becoming the Framingham study 1947-1950. *Am J Public Health* 2005;95:602.
- Qu H, Fang X: A brief review on the human encyclopedia of DNA elements (ENCODE) project. *Genomics Proteomics Bioinformatics* 2013;11:135.
- Pasic MD, Samaan S, Yousef GM: Genomic medicine: New frontiers and new challenges. *Clin Chem* 2013;59:158.
- Sudmant PH, Kitzman JO, Antonacci F, et al: Diversity of human gene copy number variation and multicopy genes. *Science* 2010;330:641.
- The 1000 Genomes Project Consortium: An integrated map of genetic variation from 1,092 human genomes. *Nature* 2013;491:56.
- Wade CH, Tarini BA, Wilfond BS: Growing up in the genomic era: Implications of whole-genome sequencing for children, families, and pediatric practice. *Annu Rev Genomics Hum Genet* 2013;14:535.
- Wheeler DA, Wang L: From human genome to cancer genome: The first decade. *Genome Res* 2013;23:1054.

Exam Questions

Section II – Enzymes, Kinetics, Mechanism, Regulation, & Bioinformatics

- Rapid shallow breathing can lead to hyperventilation, a condition wherein carbon dioxide is exhaled from the lungs more rapidly than it is produced by the tissues. Explain how hyperventilation can lead to an increase in the pH of the blood.
- A protein engineer desires to alter the active site of chymotrypsin so that it will cleave peptide bonds to the C-terminal side of aspartyl and glutamyl residues. The protein engineer will be most likely to succeed if he replaces the hydrophobic amino acid at the bottom of the active site pocket with:
 - Phenylalanine
 - Threonine
 - Glutamine
 - Lysine
 - Proline
- Select the one of the following statements that is NOT CORRECT:
 - Many mitochondrial proteins are covalently modified by the acetylation of the epsilon-amino groups of lysine residues.
 - Protein acetylation is an example of a covalent modification that can be “reversed” under physiological conditions.
 - Increased levels of acetyl-CoA tend to favor protein acetylation.
 - Acetylation increases the steric bulk of the amino acid side chains that are subject to this modification.
 - The side chain of an acetylated lysyl residue is a stronger base than that of an unmodified lysyl residue.
- Select the one of the following statements that is NOT CORRECT:
 - Acid-base catalysis is a prominent feature of the catalytic mechanism of the HIV protease.
 - Fischer lock-and-key model explains the role of transition state-stabilization in enzymic catalysis.
 - Hydrolysis of peptide bonds by serine proteases involves the transient formation of a modified enzyme.
 - Many enzymes employ metal ions as prosthetic groups or cofactors.
 - In general, enzymes bind transition state analogs more tightly than substrate analogs.
- Select the one of the following statements that is NOT CORRECT:
 - To calculate K_{eq} , the equilibrium constant for a reaction, divide the initial rate of the forward reaction ($rate_{-1}$) by the initial velocity of the reverse reaction ($rate_{-1}$).
 - The presence of an enzyme has no effect on K_{eq} .
 - For a reaction conducted at constant temperature the fraction of the potential reactant molecules possessing sufficient kinetic energy to exceed the activation energy of the reaction is a constant.
 - Enzymes and other catalysts lower the activation energy of reactions.
 - The algebraic sign of ΔG , the Gibbs free energy change for a reaction, indicates the direction in which a reaction will proceed.
- Select the one of the following statements that is NOT CORRECT:
 - As used in biochemistry, the standard state concentration for products and reactants other than protons is 1 molar.
 - ΔG is a function of the logarithm of K_{eq} .
 - As used in reaction kinetics, the term “spontaneity” refers to whether the reaction as written is favored to proceed from left to right.
 - ΔG° denotes the change in free energy that accompanies transition from the standard state to equilibrium.
 - Upon reaching equilibrium, the rates of the forward and reverse reaction both drop to zero.
- Select the one of the following statements that is NOT CORRECT:
 - Enzymes lower the activation energy for a reaction.
 - Enzymes often lower the activation energy by destabilizing transition state intermediates.
 - Active site histidyl residues frequently aid catalysis by acting as proton donors or acceptors.
 - Covalent catalysis is employed by some enzymes to provide an alternative reaction pathway.
 - The presence of an enzyme has no effect on ΔG° .
- Select the one of the following statements that is NOT CORRECT:
 - For most enzymes, the initial reaction velocity, v_i , exhibits a hyperbolic dependence on $[S]$.
 - When $[S]$ is much lower than K_m , the term $K_m + [S]$ in the Michaelis-Menten equation closely approaches K_m . Under these conditions, the rate of catalysis is a linear function of $[S]$.
 - The molar concentrations of substrates and products are equal when the rate of an enzyme-catalyzed reaction reaches half of its potential maximum value ($V_{max}/2$).
 - An enzyme is said to have become saturated with substrate when successively raising $[S]$ fails to produce a significant increase in v_i .
 - When making steady-state rate measurements, the concentration of substrates should greatly exceed that of the enzyme catalyst.
- Select the one of the following statements that is NOT CORRECT:
 - Certain monomeric enzymes exhibit sigmoidal initial rate kinetics.
 - The Hill equation is used to perform quantitative analysis of the cooperative behavior of enzymes or carrier proteins such as hemoglobin or calmodulin.
 - For an enzyme that exhibits cooperative binding of substrate, a value of n (the Hill coefficient) greater than unity is said to exhibit positive cooperativity.
 - An enzyme that catalyzes a reaction between two or more substrates is said to operate by a sequential mechanism if the substrates must bind in a fixed order.
 - Prosthetic groups enable enzymes to add chemical groups beyond those present on amino acid side chains.

10. Select the one of the following statements that is NOT CORRECT:
- IC_{50} is a simple operational term for expressing the potency of an inhibitor.
 - Lineweaver-Burk and Dixon plots employ rearranged versions of the Michaelis-Menten equation to generate linear representations of kinetic behavior and inhibition.
 - A plot of $1/v_i$ versus $1/[S]$ can be used to evaluate the type and affinity for an inhibitor.
 - Simple noncompetitive inhibitors lower the apparent K_m for a substrate.
 - Noncompetitive inhibitors typically bear little or no structural resemblance to the substrate(s) of an enzyme-catalyzed reaction.
11. Select the one of the following statements that is NOT CORRECT:
- For a given enzyme, the intracellular concentrations of its substrates tend to be close to their K_m values.
 - The sequestration of certain pathways within intracellular organelles facilitates the task of metabolic regulation.
 - The earliest step in a biochemical pathway where regulatory control can be efficiently exerted is the first committed step.
 - Feedback regulation refers to the allosteric control of an early step in a biochemical pathway by the end product(s) of that pathway.
 - Metabolic control is most effective when one of the more rapid steps in a pathway is targeted for regulation.
12. Select the one of the following statements that is NOT CORRECT:
- The Bohr effect refers to the release of protons that occurs when oxygen binds to deoxyhemoglobin.
 - Shortly after birth of a human infant, synthesis of the α -chain undergoes rapid induction until it comprises 50% of the hemoglobin tetramer.
 - The β -chain of fetal hemoglobin is present throughout gestation.
 - The term thalassemia refers to any genetic defect that results in partial or total absence of the α - or β -chains of hemoglobin.
 - The taut conformation of hemoglobin is stabilized by several salt bridges that form between the subunits.
13. Select the one of the following statements that is NOT CORRECT:
- Steric hindrance by histidine E7 plays a critical role in weakening the affinity of hemoglobin for carbon monoxide (CO).
 - Carbonic anhydrase plays a critical role in respiration by virtue of its capacity to break down 2,3-bisphosphoglycerate in the lungs.
 - Hemoglobin S is distinguished by a genetic mutation that substitutes Glu6 on the β subunit with Val, creating a sticky patch on its surface.
 - Oxidation of the heme iron from the +2 to the +3 state abolishes the ability of hemoglobin to bind oxygen.
 - The functional differences between hemoglobin and myoglobin reflect, to a large degree, differences in their quaternary structure.
14. Select the one of the following statements that is NOT CORRECT:
- The charge-relay network of trypsin makes the active site serine a stronger nucleophile.
 - The Michaelis constant is the substrate concentration at which the rate of the reaction is half-maximal.
 - During transamination reactions, both substrates are bound to the enzyme before either product is released.
 - Histidine residues act both as acids and as bases during catalysis by an aspartate protease.
 - Many coenzymes and cofactors are derived from vitamins.
15. Select the one of the following statements that is NOT CORRECT:
- Interconvertible enzymes fulfill key roles in integrated regulatory networks.
 - Phosphorylation of an enzyme often alters its catalytic efficiency.
 - "Second messengers" act as intracellular extensions or surrogates for hormones and nerve impulses impinging on cell surface receptors.
 - The ability of protein kinases to catalyze the reverse reaction that removes the phosphoryl group is key to the versatility of this molecular regulatory mechanism.
 - Zymogen activation by partial proteolysis is irreversible under physiological conditions.
16. Select the one of the following statements that is NOT CORRECT:
- The HapMap Database focuses on the location and identity of single nucleotide polymorphisms in humans.
 - Genbank is a repository of data on the phenotypic results of gene knockouts in humans.
 - The Protein Database or PDB stores the three-dimensional structures of proteins as determined by x-ray crystallography or nuclear magnetic resonance spectroscopy (NMR).
 - The objective of the ENCODE project is to identify all of the functional elements of the genome.
 - BLAST compares protein and nucleotide sequences in order to identify areas of similarity.
17. Select the one of the following statements that is NOT CORRECT:
- A major obstacle to computer-aided drug design is the extraordinary demands in computing capacity required to permit proteins and ligands a realistic degree of conformational flexibility.
 - Conformational flexibility is needed to permit ligand and protein to influence one another as described by lock-and-key models for protein-ligand binding.
 - Construction of a virtual cell could provide a means to rapidly and efficiently detect many undesirable effects of potential drugs without the need for expensive laboratory testing.
 - Systems biology highlights the manner in which the connections between enzymatic or other components in a cell affect their performance.
 - Systems biologists frequently employ the symbolic logic of computer programs and electronic circuits to describe the interactions between proteins, genes, and metabolites.

18. Select the one of the following statements that is NOT CORRECT:
- A. GRASP representations highlight areas of a protein's surface possessing local positive or negative character.
 - B. Molecular dynamics simulations seek to model the types and range of movement that conformationally flexible proteins undergo.
 - C. Researchers use rolling ball programs to locate indentations and crevices on the surface of a protein because these represent likely sites for attack by proteases.
 - D. In order to accommodate the computing power available, molecular docking simulations often restrict free rotation to only a small set of bonds in a ligand.
 - E. Discerning the evolutionary relationships between proteins constitutes one of the most effective means of predicting the likely functions of a newly discovered polypeptide.



Bioenergetics: The Role of ATP

Kathleen M. Botham, PhD, DSc & Peter A. Mayes, PhD, DSc

OBJECTIVES

After studying this chapter, you should be able to:

- State the first and second laws of thermodynamics and understand how they apply to biologic systems.
- Explain what is meant by the terms free energy, entropy, enthalpy, exergonic, and endergonic.
- Appreciate how reactions that are endergonic may be driven by coupling to those that are exergonic in biologic systems.
- Understand the role of high-energy phosphates, ATP, and other nucleotide triphosphates in the transfer of free energy from exergonic to endergonic processes, enabling them to act as the “energy currency” of cells.

BIOMEDICAL IMPORTANCE

Bioenergetics, or biochemical thermodynamics, is the study of the energy changes accompanying biochemical reactions. Biologic systems are essentially **isothermic** and use chemical energy to power living processes. The way in which an animal obtains suitable fuel from its food to provide this energy is basic to the understanding of normal nutrition and metabolism. Death from **starvation** occurs when available energy reserves are depleted, and certain forms of malnutrition are associated with energy imbalance (**marasmus**). Thyroid hormones control the **metabolic rate** (rate of energy release), and disease results if they malfunction. Excess storage of surplus energy causes **obesity**, an increasingly common disease of Western society which predisposes to many diseases, including cardiovascular disease and diabetes mellitus type 2, and lowers life expectancy.

FREE ENERGY IS THE USEFUL ENERGY IN A SYSTEM

Gibbs change in **free energy** (ΔG) is that portion of the total energy change in a system that is available for doing work—that is, the useful energy, also known as the chemical potential.

Biologic Systems Conform to the General Laws of Thermodynamics

The first law of thermodynamics states that **the total energy of a system, including its surroundings, remains constant**. It implies that within the total system, energy is neither lost nor gained during any change. However, energy may be transferred from one part of the system to another, or may be transformed into another form of energy. In living systems,

chemical energy may be transformed into heat or into electrical, radiant, or mechanical energy.

The second law of thermodynamics states that **the total entropy of a system must increase if a process is to occur spontaneously**. Entropy is the extent of disorder or randomness of the system and becomes maximum as equilibrium is approached. Under conditions of constant temperature and pressure, the relationship between the free-energy change (ΔG) of a reacting system and the change in entropy (ΔS) is expressed by the following equation, which combines the two laws of thermodynamics:

$$\Delta G = \Delta H - T\Delta S$$

where ΔH is the change in **enthalpy** (heat) and T is the absolute temperature.

In biochemical reactions, since ΔH is approximately equal to the **total change in internal energy of the reaction or ΔE** , the above relationship may be expressed in the following way:

$$\Delta G = \Delta E - T\Delta S$$

If ΔG is negative, the reaction proceeds spontaneously with loss of free energy; that is, it is **exergonic**. If, in addition, ΔG is of great magnitude, the reaction goes virtually to completion and is essentially irreversible. On the other hand, if ΔG is positive, the reaction proceeds only if free energy can be gained; that is, it is **endergonic**. If, in addition, the magnitude of ΔG is great, the system is stable, with little or no tendency for a reaction to occur. If ΔG is zero, the system is at equilibrium and no net change takes place.

When the reactants are present in concentrations of 1.0 mol/L, ΔG^0 is the standard free-energy change. For biochemical reactions, a standard state is defined as having a pH of 7.0. The standard free-energy change at this standard state is denoted by $\Delta G^{0'}$.

The standard free-energy change can be calculated from the equilibrium constant K_{eq} .

$$\Delta G^{0'} = -RT \ln K'_{eq}$$

where R is the gas constant and T is the absolute temperature (see Chapter 8). It is important to note that the actual ΔG may be larger or smaller than $\Delta G^{0'}$ depending on the concentrations of the various reactants, including the solvent, various ions, and proteins.

In a biochemical system, an enzyme only speeds up the attainment of equilibrium; it never alters the final concentrations of the reactants at equilibrium.

ENDERGONIC PROCESSES PROCEED BY COUPLING TO EXERGONIC PROCESSES

The vital processes—for example, synthetic reactions, muscular contraction, nerve impulse conduction, and active transport—obtain energy by chemical linkage, or **coupling**, to oxidative reactions. In its simplest form, this type of coupling may be represented as shown in **Figure 11-1**. The conversion of

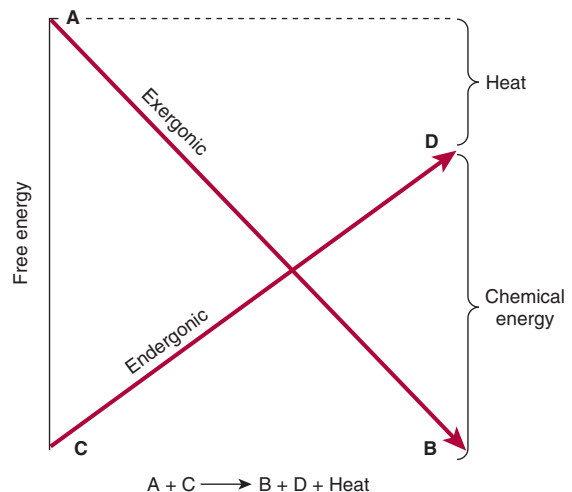
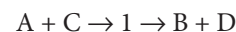

FIGURE 11-1 Coupling of an exergonic to an endergonic reaction.

metabolite A to metabolite B occurs with release of free energy and is coupled to another reaction in which free energy is required to convert metabolite C to metabolite D. The terms **exergonic** and **endergonic**, rather than the normal chemical terms “exothermic” and “endothermic,” are used to indicate that a process is accompanied by loss or gain, respectively, of free energy in any form, not necessarily as heat. In practice, an endergonic process cannot exist independently, but must be a component of a coupled exergonic-endergonic system where the overall net change is exergonic. The exergonic reactions are termed **catabolism** (generally, the breakdown or oxidation of fuel molecules), whereas the synthetic reactions that build up substances are termed **anabolism**. The combined catabolic and anabolic processes constitute **metabolism**.

If the reaction shown in Figure 11-1 is to go from left to right, then the overall process must be accompanied by loss of free energy as heat. One possible mechanism of coupling could be envisaged if a common obligatory intermediate (I) took part in both reactions, that is,



Some exergonic and endergonic reactions in biologic systems are coupled in this way. This type of system has a built-in mechanism for biologic control of the rate of oxidative processes since the common obligatory intermediate allows the rate of utilization of the product of the synthetic path (D) to determine by mass action the rate at which A is oxidized. Indeed, these relationships supply a basis for the concept of **respiratory control**, the process that prevents an organism from burning out of control. An extension of the coupling concept is provided by dehydrogenation reactions, which are coupled to hydrogenations by an intermediate carrier (**Figure 11-2**).

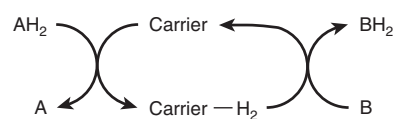

FIGURE 11-2 Coupling of dehydrogenation and hydrogenation reactions by an intermediate carrier.

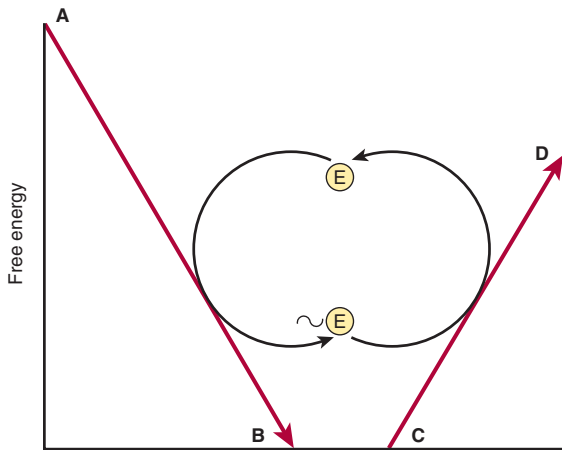

FIGURE 11-3 Transfer of free energy from an exergonic to an endergonic reaction via a high-energy intermediate compound ($\sim\text{E}$).

An alternative method of coupling an exergonic to an endergonic process is to synthesize a compound of high-energy potential in the exergonic reaction and to incorporate this new compound into the endergonic reaction, thus effecting a transference of free energy from the exergonic to the endergonic pathway (Figure 11-3). The biologic advantage of this mechanism is that the compound of high potential energy, $\sim\text{E}$, unlike I in the previous system, need not be structurally related to A, B, C, or D, allowing E to serve as a transducer of energy from a wide range of exergonic reactions to an equally wide range of endergonic reactions or processes, such as biosyntheses, muscular contraction, nervous excitation, and active transport. In the living cell, the principal high-energy intermediate or carrier compound (designated $\sim\text{E}$ in Figure 11-3) is **adenosine triphosphate (ATP)** (Figure 11-4).

HIGH-ENERGY PHOSPHATES PLAY A CENTRAL ROLE IN ENERGY CAPTURE AND TRANSFER

In order to maintain living processes, all organisms must obtain supplies of free energy from their environment. **Autotrophic** organisms utilize simple exergonic processes; eg, the energy of sunlight (green plants), the reaction $\text{Fe}^{2+} \rightarrow \text{Fe}^{3+}$ (some bacteria). On the other hand, **heterotrophic** organisms obtain free energy by coupling their metabolism to the breakdown of complex organic molecules in their environment. In all these organisms, ATP plays a central role in the transference of free energy from the exergonic to the endergonic processes (Figure 11-3). ATP is a nucleotide consisting of the nucleoside adenosine (adenine linked to ribose), and three phosphate groups (see Chapter 32). In its reactions in the cell, it functions as the Mg^{2+} complex (Figure 11-4).

The importance of phosphates in intermediary metabolism became evident with the discovery of the role of ATP, adenosine diphosphate (ADP) (Figure 11-4), and inorganic phosphate (P_i) in glycolysis (see Chapter 17).

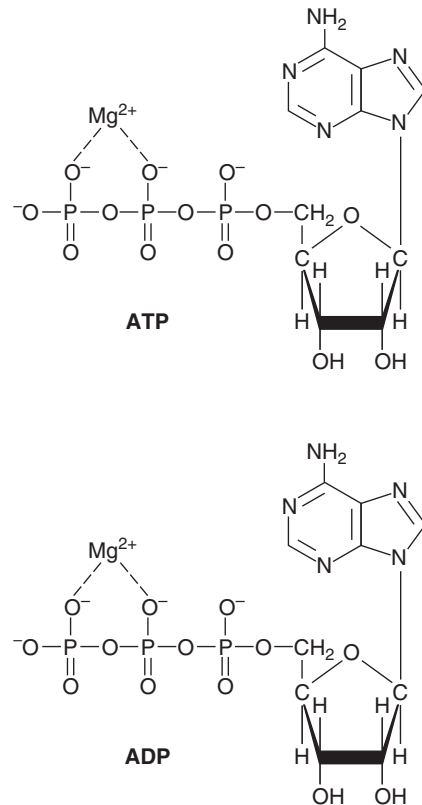

FIGURE 11-4 Adenosine triphosphate (ATP) and adenosine diphosphate shown as the magnesium complexes.

The Intermediate Value for the Free Energy of Hydrolysis of ATP Has Important Bioenergetic Significance

The standard free energy of hydrolysis of a number of biochemically important phosphates is shown in Table 11-1. An estimate of the comparative tendency of each of the phosphate groups to transfer to a suitable acceptor may be obtained from the ΔG° of hydrolysis at 37°C. The value for the hydrolysis of the terminal phosphate of ATP divides the list into two groups. **Low-energy phosphates**, exemplified by the ester phosphates found in the intermediates of glycolysis, have G° values smaller than that of ATP, while in **high-energy phosphates** the value is higher than that of ATP. The components of this latter group, including ATP, are usually anhydrides (eg, the 1-phosphate of 1,3-bisphosphoglycerate), enolphosphates (eg, phosphoenolpyruvate), and phosphoguanidines (eg, creatine phosphate, arginine phosphate).

The symbol $\sim\text{P}$ indicates that the group attached to the bond, on transfer to an appropriate acceptor, results in transfer of the larger quantity of free energy. For this reason, the term **group transfer potential**, rather than “high-energy bond,” is preferred by some. Thus, ATP contains two high-energy phosphate groups and ADP contains one, whereas the phosphate in AMP (adenosine monophosphate) is of the low-energy type since it is a normal ester link (Figure 11-5).

TABLE 11-1 Standard Free Energy of Hydrolysis of Some Organophosphates of Biochemical Importance

Compound	ΔG°	
	kJ/mol	kcal/mol
Phosphoenolpyruvate	-61.9	-14.8
Carbamoyl phosphate	-51.4	-12.3
1,3-Bisphosphoglycerate (to 3-phosphoglycerate)	-49.3	-11.8
Creatine phosphate	-43.1	-10.3
ATP \rightarrow AMP + PP _i	-32.2	-7.7
ATP \rightarrow ADP + P _i	-30.5	-7.3
Glucose-1-phosphate	-20.9	-5.0
PP _i	-19.2	-4.6
Fructose-6-phosphate	-15.9	-3.8
Glucose-6-phosphate	-13.8	-3.3
Glycerol-3-phosphate	-9.2	-2.2

Abbreviations: PP_i, pyrophosphate; P_i, inorganic orthophosphate.

Note: All values taken from Jencks (1976), except that for PP_i, which is from Frey and Arabshahi (1995). Values differ between investigators, depending on the precise conditions under which the measurements were made.

The intermediate position of ATP allows it to play an important role in energy transfer. The high free-energy change on hydrolysis of ATP is due to relief of charge repulsion of adjacent negatively charged oxygen atoms and to stabilization of the reaction products, especially phosphate, as resonance hybrids (Figure 11-6). Other “high-energy compounds”

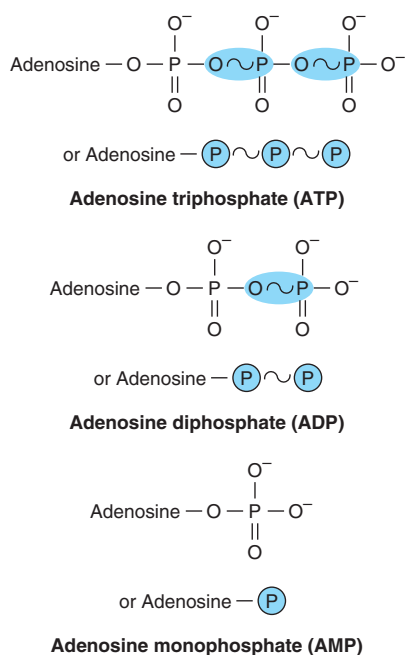
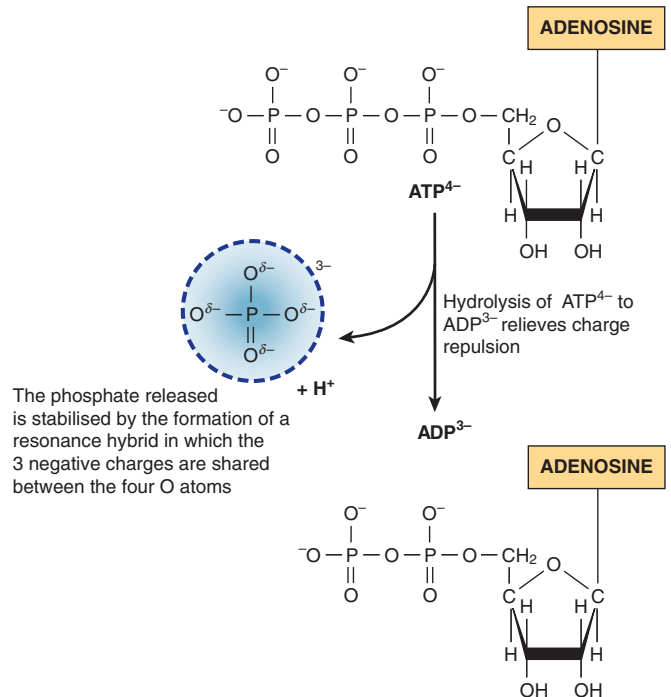
**FIGURE 11-5** Structure of ATP, ADP, and AMP showing the position and the number of high-energy phosphates (~P).**FIGURE 11-6** The free-energy change on hydrolysis of ATP to ADP.

are thiol esters involving coenzyme A (eg, acetyl-CoA), acyl carrier protein, amino acid esters involved in protein synthesis, *S*-adenosylmethionine (active methionine), UDPGlc (uridine diphosphate glucose), and PRPP (5-phosphoribosyl-1-pyrophosphate).

HIGH-ENERGY PHOSPHATES ACT AS THE “ENERGY CURRENCY” OF THE CELL

ATP is able to act as a donor of high-energy phosphate to form those compounds below it in Table 11-1. Likewise, with the necessary enzymes, ADP can accept high-energy phosphate to form ATP from those compounds above ATP in the table. In effect, an **ATP/ADP cycle** connects those processes that generate ~P to those processes that utilize ~P (Figure 11-7), continuously consuming and regenerating ATP. This occurs at a very rapid rate since the total ATP/ADP pool is extremely small and sufficient to maintain an active tissue for only a few seconds.

There are three major sources of ~P taking part in **energy conservation or energy capture**:

- Oxidative phosphorylation** is the greatest quantitative source of ~P in aerobic organisms. ATP is generated in the mitochondrial matrix as O₂ is reduced to H₂O by electrons passing down the respiratory chain (see Chapter 13).
- Glycolysis.** A net formation of two ~P results from the formation of lactate from one molecule of glucose, generated in two reactions catalyzed by phosphoglycerate kinase and pyruvate kinase, respectively (see Figure 17-2).

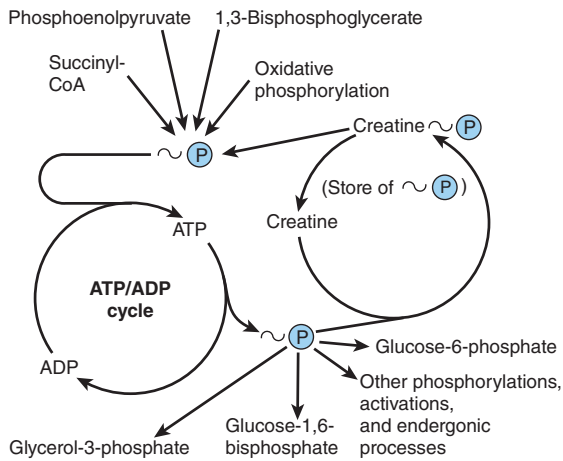
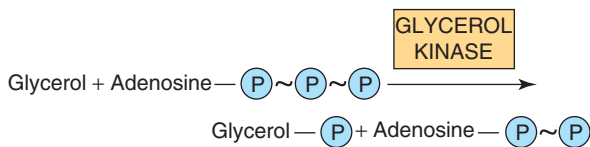

FIGURE 11-7 Role of ATP/ADP cycle in transfer of high-energy phosphate.

3. **The citric acid cycle.** One $\sim\text{P}$ is generated directly in the cycle at the succinate thiokinase step (see Figure 16-3).

Phosphagens act as storage forms of high-energy phosphate and include **creatine phosphate**, which occurs in vertebrate skeletal muscle, heart, spermatozoa, and brain, and **arginine phosphate**, which occurs in invertebrate muscle. When ATP is rapidly being utilized as a source of energy for muscular contraction, phosphagens permit its concentrations to be maintained, but when the ATP/ADP ratio is high, their concentration can increase to act as a store of high-energy phosphate (Figure 11-8).

When ATP acts as a phosphate donor to form compounds of lower free energy of hydrolysis (Table 11-1), the phosphate group is invariably converted to one of low energy. For example, the phosphorylation of glycerol to form glycerol-3-phosphate:



ATP Allows the Coupling of Thermodynamically Unfavorable Reactions to Favorable Ones

Endergonic reactions cannot proceed without an input of free energy. For example, the phosphorylation of glucose

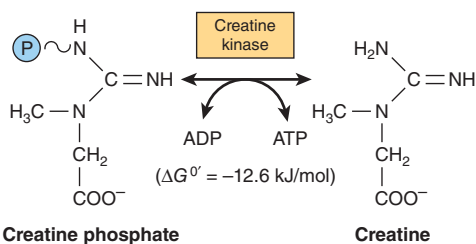
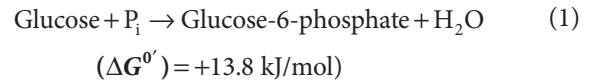
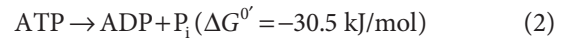

FIGURE 11-8 Transfer of high-energy phosphate between ATP and creatine.

to glucose-6-phosphate, the first reaction of glycolysis (see Figure 17-2):



is highly endergonic and cannot proceed under physiologic conditions. Thus, in order to take place, the reaction must be coupled with another—more exergonic—reaction such as the hydrolysis of the terminal phosphate of ATP.



When (1) and (2) are coupled in a reaction catalyzed by hexokinase, phosphorylation of glucose readily proceeds in a highly exergonic reaction that under physiologic conditions is irreversible. Many “activation” reactions follow this pattern.

Adenylate Kinase (Myokinase) Interconverts Adenine Nucleotides

This enzyme is present in most cells. It catalyzes the following reaction:

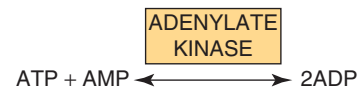

Adenylate kinase is important for the maintenance of energy homeostasis in cells because it allows:

1. High-energy phosphate in ADP to be used in the synthesis of ATP.
2. The AMP formed as a consequence of activating reactions involving ATP to be rephosphorylated to ADP.
3. AMP to increase in concentration when ATP becomes depleted so that it is able to act as a metabolic (allosteric) signal to increase the rate of catabolic reactions, which in turn lead to the generation of more ATP (see Chapter 14).

When ATP Forms AMP, Inorganic Pyrophosphate (PP_i) Is Produced

ATP can also be hydrolyzed directly to AMP, with the release of PP_i (Table 11-1). This occurs, for example, in the activation of long-chain fatty acids (see Chapter 22).

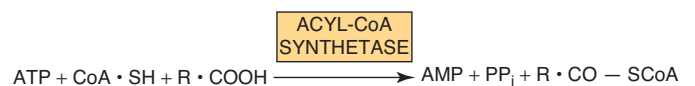

This reaction is accompanied by loss of free energy as heat, which ensures that the activation reaction will go to the right, and is further aided by the hydrolytic splitting of PP_i, catalyzed by **inorganic pyrophosphatase**, a reaction that itself has a large $\Delta G^{0'}$ of -19.2 kJ/mol . Note that activations via the

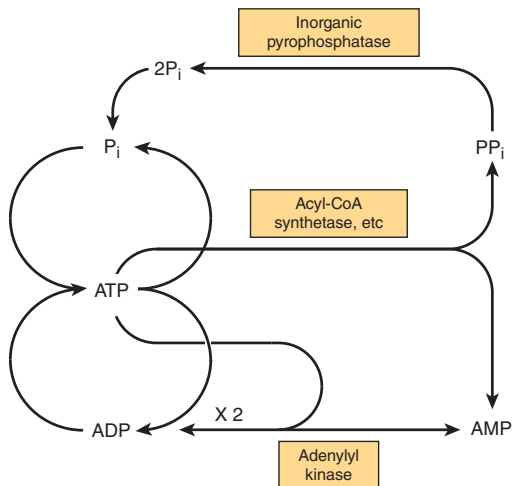
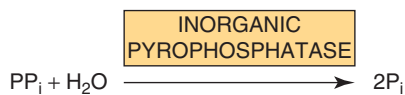

FIGURE 11-9 Phosphate cycles and interchange of adenine nucleotides.

pyrophosphate pathway result in the loss of two $\sim\text{P}$ rather than one, as occurs when ADP and P_i are formed.



A combination of the above reactions makes it possible for phosphate to be recycled and the adenine nucleotides to interchange (**Figure 11-9**).

Other Nucleoside Triphosphates Participate in the Transfer of High-Energy Phosphate

By means of the **nucleoside diphosphate (NDP) kinases**, UTP, GTP, and CTP can be synthesized from their diphosphates, for example, UDP reacts with ATP to form UTP.

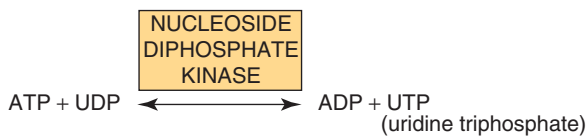

All of these triphosphates take part in phosphorylations in the cell. Similarly, specific **nucleoside monophosphate (NMP) kinases** catalyze the formation of nucleoside diphosphates from the corresponding monophosphates.

Thus, adenylyl kinase is a specialized NMP kinase.

SUMMARY

- Biologic systems use chemical energy to power living processes.
- Exergonic reactions take place spontaneously with loss of free energy (ΔG is negative). Endergonic reactions require the gain of free energy (ΔG is positive) and occur only when coupled to exergonic reactions.
- ATP acts as the “energy currency” of the cell, transferring free energy derived from substances of higher energy potential to those of lower energy potential.

REFERENCES

- de Meis L: The concept of energy-rich phosphate compounds: water, transport ATPases, and entropy energy. *Arch Biochem Biophys* 1993;306:287.
- Frey PA, Arabshahi A: Standard free-energy change for the hydrolysis of the alpha, beta-phosphoanhydride bridge in ATP. *Biochemistry* 1995;34:11307.
- Harris DA: *Bioenergetics at a Glance: An Illustrated Introduction*. Blackwell Publishing, 1995.
- Haynie D: *Biological Thermodynamics*. Cambridge University Press, 2008.
- Jencks WP: Free energies of hydrolysis and decarboxylation. In: *Handbook of Biochemistry and Molecular Biology*, vol 1. *Physical and Chemical Data*. Fasman GD (editor). CRC Press, 1976:296–304.
- Nicholls DG, Ferguson SJ: *Bioenergetics*, 4th ed. Elsevier, 2013.

Biologic Oxidation

Kathleen M. Botham, PhD, DSc & Peter A. Mayes, PhD, DSc

OBJECTIVES

After studying this chapter, you should be able to:

- Understand the meaning of redox potential and explain how it can be used to predict the direction of flow of electrons in biologic systems.
- Identify the four classes of enzymes (oxidoreductases) involved in oxidation and reduction reactions.
- Describe the action of oxidases and provide examples of where they play an important role in metabolism.
- Indicate the two main functions of dehydrogenases and explain the importance of NAD- and riboflavin-linked dehydrogenases in metabolic pathways such as glycolysis, the citric acid cycle, and the respiratory chain.
- Identify the two types of enzymes classified as hydroperoxidases; indicate the reactions they catalyze and explain why they are important.
- Give the two steps of reactions catalyzed by oxygenases and identify the two subgroups of this class of enzymes.
- Appreciate the role of cytochrome P450 in drug detoxification and steroid synthesis.
- Describe the reaction catalyzed by superoxide dismutase and explain how it protects tissues from oxygen toxicity.

BIOMEDICAL IMPORTANCE

Chemically, **oxidation** is defined as the removal of electrons and **reduction** as the gain of electrons. Thus, oxidation of a molecule (the electron donor) is always accompanied by reduction of a second molecule (the electron acceptor). This principle of oxidation-reduction applies equally to biochemical systems and is an important concept underlying understanding of the nature of biologic oxidation. Note that many biologic oxidations can take place without the participation of molecular oxygen, for example, dehydrogenations. The life of higher animals is absolutely dependent upon a supply of oxygen for **respiration**, the process by which cells derive energy in the form of ATP from the controlled reaction of hydrogen with oxygen to form water. In addition, molecular oxygen is incorporated into a variety of substrates by enzymes designated as **oxygenases**; many drugs, pollutants, and chemical carcinogens (xenobiotics) are metabolized by enzymes of this class, known as the **cytochrome P450 system**. Administration of oxygen can be lifesaving in the treatment of patients with respiratory or circulatory failure.

FREE ENERGY CHANGES CAN BE EXPRESSED IN TERMS OF REDOX POTENTIAL

In reactions involving oxidation and reduction, the free energy change is proportionate to the tendency of reactants to donate or accept electrons. Thus, in addition to expressing free energy change in terms of ΔG° (see Chapter 11), it is possible, in an analogous manner, to express it numerically as an **oxidation-reduction** or **redox potential** (E'_{\circ}). Chemically, the redox potential of a system (E_{\circ}) is usually compared with the potential of the hydrogen electrode (0.0 V at pH 0.0). However, for biologic systems, the redox potential (E'_{\circ}) is normally expressed at pH 7.0, at which pH the electrode potential of the hydrogen electrode is -0.42 V. The redox potentials of some redox systems of special interest in mammalian biochemistry are shown in **Table 12-1**. The relative positions of redox systems in the table allow prediction of the direction of flow of electrons from one redox couple to another.

TABLE 12-1 Some Redox Potentials of Special Interest in Mammalian Oxidation Systems

System	E'_0 Volts
H ⁺ /H ₂	-0.42
NAD ⁺ /NADH	-0.32
Lipoate; ox/red	-0.29
Acetoacetate/3-hydroxybutyrate	-0.27
Pyruvate/lactate	-0.19
Oxaloacetate/malate	-0.17
Fumarate/succinate	+0.03
Cytochrome <i>b</i> ; Fe ³⁺ /Fe ²⁺	+0.08
Ubiquinone; ox/red	+0.10
Cytochrome <i>c</i> ₁ ; Fe ³⁺ /Fe ²⁺	+0.22
Cytochrome <i>a</i> ; Fe ³⁺ /Fe ²⁺	+0.29
Oxygen/water	+0.82

Enzymes involved in oxidation and reduction are called **oxidoreductases** and are classified into four groups: **oxidases**, **dehydrogenases**, **hydroperoxidases**, and **oxygenases**.

OXIDASES USE OXYGEN AS A HYDROGEN ACCEPTOR

Oxidases catalyze the removal of hydrogen from a substrate using oxygen as a hydrogen acceptor.* They form water or hydrogen peroxide as a reaction product (Figure 12-1).

Cytochrome Oxidase Is a Hemoprotein

Cytochrome oxidase is a hemoprotein widely distributed in many tissues, having the typical heme prosthetic group present in myoglobin, hemoglobin, and other cytochromes (see Chapter 6). It is the terminal component of the chain of respiratory carriers found in mitochondria (see Chapter 13) and transfers electrons resulting from the oxidation of substrate molecules by dehydrogenases to their final acceptor, oxygen. The action of the enzyme is blocked by **carbon monoxide**, **cyanide**, and **hydrogen sulfide**, and this causes poisoning by preventing cellular respiration. It has also been termed “cytochrome *a*₃.” However, it is now known that the heme *a*₃ is combined with another heme, heme *a*, in a single protein to form the cytochrome oxidase enzyme complex, and so it is more correctly termed **cytochrome *aa*₃**. It contains two molecules of heme, each having one Fe atom that oscillates between

*The term “oxidase” is sometimes used collectively to denote all enzymes that catalyze reactions involving molecular oxygen.

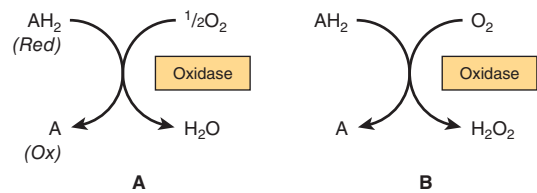
**FIGURE 12-1** Oxidation of a metabolite catalyzed by an oxidase (A) forming H₂O and (B) forming H₂O₂.

Fe³⁺ and Fe²⁺ during oxidation and reduction. Furthermore, two atoms of Cu are present, each associated with a heme unit.

Other Oxidases Are Flavoproteins

Flavoprotein enzymes contain **flavin mononucleotide (FMN)** or **flavin adenine dinucleotide (FAD)** as prosthetic groups. FMN and FAD are formed in the body from the vitamin **riboflavin** (see Chapter 44). FMN and FAD are usually tightly—but not covalently—bound to their respective apoenzyme proteins. Metalloflavoproteins contain one or more metals as essential cofactors. Examples of flavoprotein oxidases include **L-amino acid oxidase**, an enzyme found in kidney with general specificity for the oxidative deamination of the naturally occurring L-amino acids; **xanthine oxidase**, which contains molybdenum and plays an important role in the conversion of purine bases to uric acid (see Chapter 33), and is of particular significance in uricotelic animals (see Chapter 28); and **aldehyde dehydrogenase**, an FAD-linked enzyme present in mammalian livers, which contains molybdenum and nonheme iron and acts upon aldehydes and *N*-heterocyclic substrates. The mechanisms of oxidation and reduction of these enzymes are complex. Evidence suggests a two-step reaction as shown in Figure 12-2.

DEHYDROGENASES CANNOT USE OXYGEN AS A HYDROGEN ACCEPTOR

There are a large number of enzymes in the dehydrogenase class. They perform the following two main functions:

1. Transfer of hydrogen from one substrate to another in a coupled oxidation–reduction reaction (Figure 12-3). These dehydrogenases are specific for their substrates but often utilize common coenzymes or hydrogen carriers, for example, NAD⁺. Since the reactions are reversible, these properties enable reducing equivalents to be freely transferred within the cell. This type of reaction, which enables one substrate to be oxidized at the expense of another, is particularly useful in enabling oxidative processes to occur in the absence of oxygen, such as during the anaerobic phase of glycolysis (see Figure 17-2).
2. Transfer of electrons in the **respiratory chain** of electron transport from substrate to oxygen (see Figure 13-3).

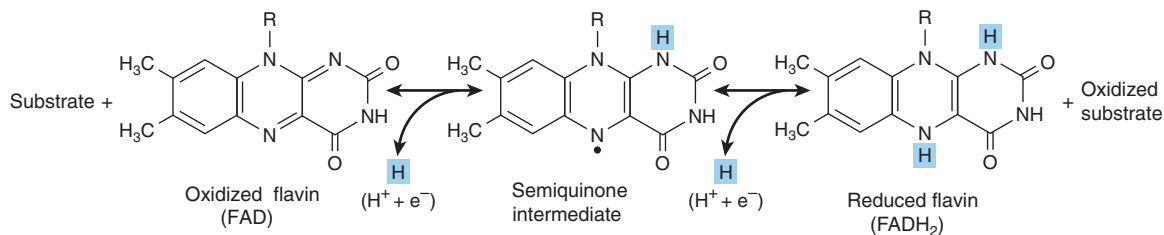
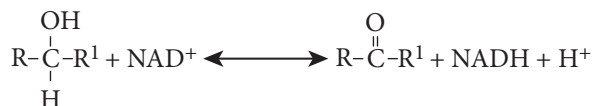

FIGURE 12-2 Oxidoreduction of isoalloxazine ring in flavin nucleotides via a semiquinone intermediate. In oxidation reactions, the flavin (eg, FAD) accepts 2 electrons and 2 H⁺ in 2 steps, forming the semiquinone intermediate followed by the reduced flavin (eg, FADH₂) and the substrate is oxidized. In the reverse (reduction) reaction, the reduced flavin gives up 2 electrons and 2 H⁺ so that it becomes oxidized (eg, to FAD) and the substrate is reduced.

Many Dehydrogenases Depend on Nicotinamide Coenzymes

These dehydrogenases use **nicotinamide adenine dinucleotide (NAD⁺)** or **nicotinamide adenine dinucleotide phosphate (NADP⁺)**—or both—which are formed in the body from the vitamin **niacin** (see Chapter 44). The structure of NAD⁺ is shown in **Figure 12-4**. NADP⁺ has a phosphate group esterified to the 2' hydroxyl of its adenosine moiety, but otherwise is identical to NAD⁺. The oxidized forms of both nucleotides have a positive charge on the nitrogen atom of the nicotinamide moiety as indicated in **Figure 12-4**. The coenzymes are reduced by the specific substrate of the dehydrogenase and reoxidized by a suitable electron acceptor. They are able to freely and reversibly dissociate from their respective apoenzymes.

Generally, **NAD-linked dehydrogenases** catalyze oxidation-reduction reactions of the type:



When a substrate is oxidized, it loses 2 hydrogen atoms and 2 electrons. One H⁺ and both electrons are accepted by NAD⁺ to form NADH and the other H⁺ is released (Figure 12-4). Many such reactions occur in the oxidative pathways of metabolism, particularly in glycolysis (see Chapter 17) and the citric acid cycle (see Chapter 16). NADH is generated in these pathways via the oxidation of fuel molecules, and NAD⁺ is regenerated by the oxidation of NADH as it transfers the electrons to O₂ via the respiratory chain in mitochondria, a process which leads to the formation of ATP (see Chapter 13). **NADP-linked dehydrogenases** are found characteristically biosynthetic pathways

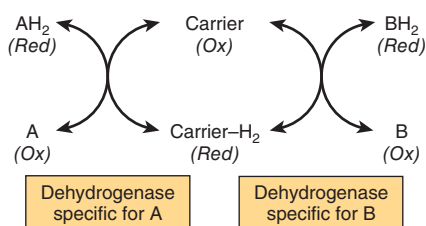
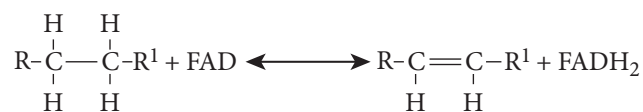

FIGURE 12-3 Oxidation of a metabolite catalyzed by coupled dehydrogenases.

where reductive reactions are required, as in the extramitochondrial pathway of fatty acid synthesis (see Chapter 23) and steroid synthesis (see Chapter 26)—and also in the pentose phosphate pathway (see Chapter 20).

Other Dehydrogenases Depend on Riboflavin

The **flavin groups** such as **FMN** and **FAD** are associated with dehydrogenases as well as with oxidases as described above. FAD is the electron acceptor in reactions of the type:



FAD accepts 2 electrons and 2 H⁺ in the reaction (Figure 12-2), forming **FADH₂**. Flavin groups are generally more tightly bound to their apoenzymes than are the nicotinamide coenzymes. Most of the **riboflavin-linked dehydrogenases** are concerned with electron transport in (or to) the respiratory chain (see Chapter 13). **NADH dehydrogenase** acts as a carrier of electrons between NADH and the components of higher redox potential (see Figure 13-3). Other dehydrogenases such as **succinate dehydrogenase**, **acyl-CoA dehydrogenase**, and **mitochondrial glycerol-3-phosphate dehydrogenase** transfer reducing equivalents directly from the substrate to the respiratory chain (see Figure 13-5). Another role of the flavin-dependent dehydrogenases is in the dehydrogenation (by **dihydrolipoyl dehydrogenase**) of reduced lipoate, an intermediate in the oxidative decarboxylation of pyruvate and α-ketoglutarate (see Figures 13-5 and 17-5). The **electron-transferring flavoprotein (ETF)** is an intermediary carrier of electrons between acyl-CoA dehydrogenase and the respiratory chain (see Figure 13-5).

Cytochromes May Also Be Regarded as Dehydrogenases

The **cytochromes** are iron-containing hemoproteins in which the iron atom oscillates between Fe³⁺ and Fe²⁺ during oxidation and reduction. Except for cytochrome oxidase (previously described), they are classified as dehydrogenases. In the respiratory chain,

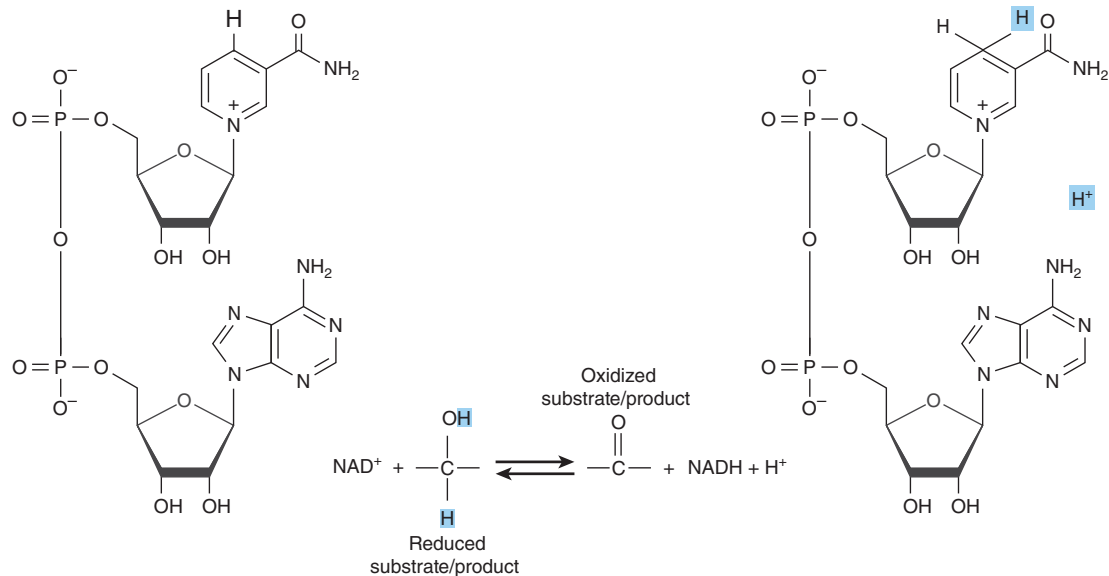

FIGURE 12-4 Oxidation and reduction of nicotinamide coenzymes. Nicotinamide coenzymes consist of a nicotinamide ring linked to an adenosine via a ribose and a phosphate group, forming a dinucleotide. NAD^+ / NADH are shown, but NADP^+ / NADPH are identical except that they have a phosphate group esterified to the 2'OH of the adenosine. An oxidation reaction involves the transfer of two electrons and one H^+ from the substrate to the nicotinamide ring of NAD^+ forming NADH and the oxidized product. The remaining hydrogen of the hydrogen pair removed from the substrate remains free as a hydrogen ion. NADH is oxidized to NAD^+ by the reverse reaction.

they are involved as carriers of electrons from flavoproteins on the one hand to cytochrome oxidase on the other (see Figure 13-5). Several identifiable cytochromes occur in the respiratory chain, ie, cytochromes *b*, *c*₁, *c*, and cytochrome oxidase. Cytochromes are also found in other locations, for example, the endoplasmic reticulum (cytochromes P450 and *b*₅), and in plant cells, bacteria, and yeasts.

HYDROPEROXIDASES USE HYDROGEN PEROXIDE OR AN ORGANIC PEROXIDE AS SUBSTRATE

Two type of enzymes found both in animals and plants fall into the **hydroperoxidase** category: **peroxidases** and **catalase**.

Hydroperoxidases play an important role in protecting the body against the harmful effects of **reactive oxygen species (ROS)**. ROS are highly reactive oxygen-containing molecules such as peroxides which are formed during normal metabolism, but can be damaging if they accumulate. They are believed to contribute to the causation of diseases such as cancer and atherosclerosis, as well as the aging process in general (see Chapters 21, 44, 54).

Peroxidases Reduce Peroxides Using Various Electron Acceptors

Peroxidases are found in milk and in leukocytes, platelets, and other tissues involved in eicosanoid metabolism (see Chapter 23). Their prosthetic group is **protoheme**. In the reaction catalyzed

by peroxidase, hydrogen peroxide is reduced at the expense of several substances that will act as electron acceptors, such as ascorbate (vitamin C), quinones, and cytochrome *c*. The reaction catalyzed by peroxidase is complex, but the overall reaction is as follows:

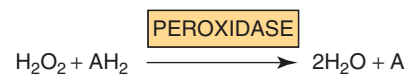

In erythrocytes and other tissues, the enzyme **glutathione peroxidase**, containing **selenium** as a prosthetic group, catalyzes the destruction of H_2O_2 and lipid hydroperoxides through the conversion of reduced glutathione to its oxidized form, protecting membrane lipids and hemoglobin against oxidation by peroxides (see Chapter 21).

Catalase Uses Hydrogen Peroxide as Electron Donor & Electron Acceptor

Catalase is a hemoprotein containing four heme groups. It can act as a peroxidase, catalyzing reactions of the type shown above, but it is also able to catalyze the breakdown of H_2O_2 formed by the action of oxygenases to water and oxygen:



This reaction uses one molecule of H_2O_2 as a substrate electron donor and another molecule of H_2O_2 as an oxidant or electron acceptor. It is one of the fastest enzyme reactions known, destroying millions of potentially damaging H_2O_2 molecules

per second. Under most conditions *in vivo*, the peroxidase activity of catalase seems to be favored. Catalase is found in blood, bone marrow, mucous membranes, kidney, and liver. **Peroxisomes** are found in many tissues, including liver. They are rich in oxidases and in catalase. Thus, the enzymes that produce H_2O_2 are grouped with the enzyme that breaks it down. However, mitochondrial and microsomal electron transport systems as well as xanthine oxidase must be considered as additional sources of H_2O_2 .

OXYGENASES CATALYZE THE DIRECT TRANSFER & INCORPORATION OF OXYGEN INTO A SUBSTRATE MOLECULE

Oxygenases are concerned with the synthesis or degradation of many different types of metabolites. They catalyze the incorporation of oxygen into a substrate molecule in two steps: (1) oxygen is bound to the enzyme at the active site and (2) the bound oxygen is reduced or transferred to the substrate. Oxygenases may be divided into two subgroups, dioxygenases and monooxygenases.

Dioxygenases Incorporate Both Atoms of Molecular Oxygen into the Substrate

The basic reaction catalyzed by dioxygenases is shown below:

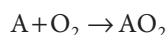

Examples include the liver enzymes, **homogentisate dioxygenase** (oxidase) and **3-hydroxyanthranilate dioxygenase**

(oxidase), which contain iron; and **L-tryptophan dioxygenase** (tryptophan pyrrolase) (see Chapter 29), which utilizes heme.

Monooxygenases (Mixed-Function Oxidases, Hydroxylases) Incorporate Only One Atom of Molecular Oxygen Into the Substrate

The other oxygen atom is reduced to water, an additional electron donor or cosubstrate (Z) being necessary for this purpose:

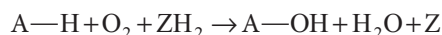

Cytochromes P450 Are Monooxygenases Important in Steroid Metabolism & for the Detoxification of Many Drugs

Cytochromes P450 are an important superfamily of heme-containing monooxygenases, and >50 such enzymes have been found in the human genome. They are located mainly in the endoplasmic reticulum in the liver and intestine, but are also found in the mitochondria in some tissues. The cytochromes participate in an electron transport chain in which both NADH and NADPH may donate reducing equivalents. Electrons are passed to cytochrome P450 in two types of reaction involving FAD or FMN. Class I systems consist of an FAD-containing reductase enzyme, an iron sulfur (Fe_2S_2) protein and the P450 heme protein, while class II systems contain cytochrome P450 reductase which passes electrons from $FADH_2$ to FMN (**Figure 12-5**). Class I and II systems are well characterized, but in recent years other cytochrome

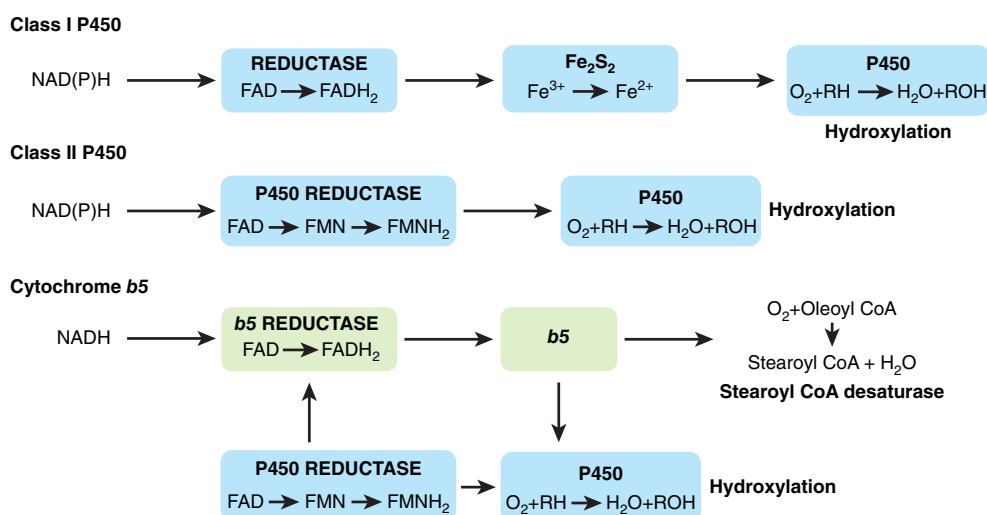

FIGURE 12-5 Cytochromes P450 and *b5* in the endoplasmic reticulum. Most cytochromes P450 are class I or class II. In addition to cytochrome P450, class I systems contain a small FAD-containing reductase and an iron sulfur protein, and class II contain cytochrome P450 reductase, which incorporates FAD and FMN. Cytochromes P450 catalyze many steroid hydroxylation reactions and drug detoxification steps. Cytochrome *b5* acts in conjunction with the FAD-containing cytochrome *b5* reductase in the fatty acyl CoA desaturase (eg, stearoyl CoA desaturase) reaction and also works together with cytochromes P450 in drug detoxification. It is able to accept electrons from cytochrome P450 reductase via cytochrome *b5* reductase and donate them to cytochrome P450.

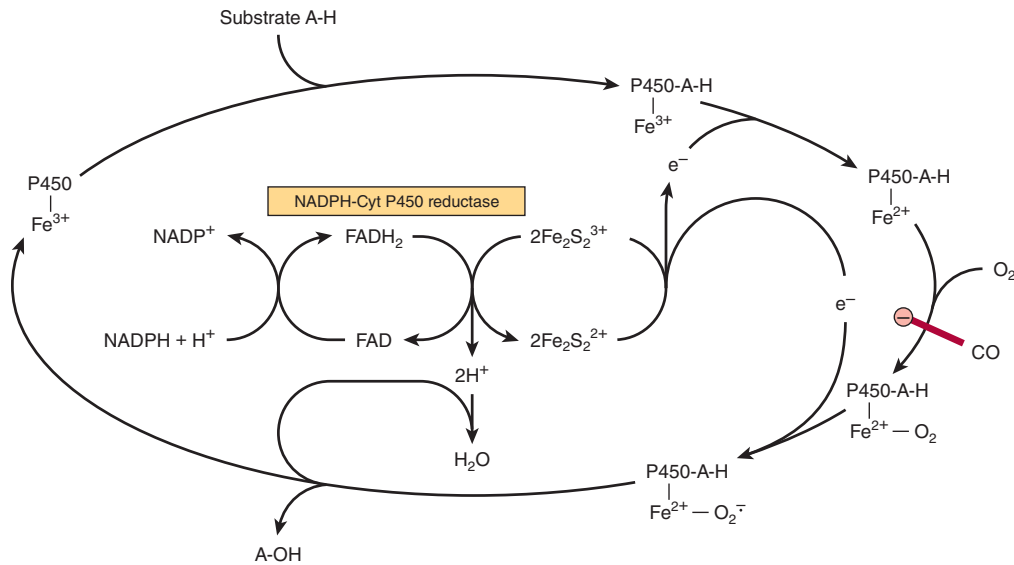

FIGURE 12-6 Cytochrome P450 hydroxylase cycle. The system shown is typical of steroid hydroxylases of the adrenal cortex. Liver microsomal cytochrome P450 hydroxylase does not require the iron-sulfur protein Fe_2S_2 . Carbon monoxide (CO) inhibits the indicated step.

P450s which do not fit into either category have been identified. In the final step oxygen accepts the electrons from cytochrome P450 and is reduced, with one atom being incorporated into H_2O and the other into the substrate, usually resulting in its hydroxylation. This series of enzymatic reactions, known as the **hydroxylase cycle**, is illustrated in **Figure 12-6**. In the endoplasmic reticulum of the liver, cytochromes P450 are found together with another heme-containing protein, **cytochrome b_5** (Figure 12-5) and together they have a major role in drug metabolism and detoxification. Cytochrome b_5 also has an important role as a fatty acid desaturase. Together, cytochromes P450 and b_5 are responsible for about 75% of the modification and degradation of drugs which occurs in the body. The rate of detoxification of many medicinal drugs by cytochromes P450 determines the duration of their action. Benzpyrene, aminopyrine, aniline, morphine, and benzphetamine are hydroxylated, increasing their solubility and aiding their excretion. Many drugs such as phenobarbital have the ability to induce the synthesis of cytochromes P450.

Mitochondrial cytochrome P450 systems are found in steroidogenic tissues such as adrenal cortex, testis, ovary, and placenta and are concerned with the biosynthesis of steroid hormones from cholesterol (hydroxylation at C_{22} and C_{20} in side-chain cleavage and at the 11β and 18 positions). In addition, renal systems catalyzing 1α - and 24-hydroxylations of 25-hydroxycholecalciferol in vitamin D metabolism—and cholesterol 7α -hydroxylase and sterol 27-hydroxylase involved in bile acid biosynthesis from cholesterol in the liver (see Chapters 26, 41)—are P450 enzymes.

SUPEROXIDE DISMUTASE PROTECTS AEROBIC ORGANISMS AGAINST OXYGEN TOXICITY

Transfer of a single electron to O_2 generates the potentially damaging **superoxide anion free radical** (O_2^-), which gives rise to free-radical chain reactions (see Chapter 21), amplifying its destructive effects. The ease with which superoxide can be formed from oxygen in tissues and the occurrence of **superoxide dismutase (SOD)**, the enzyme responsible for its removal in all aerobic organisms (although not in obligate anaerobes), indicate that the potential toxicity of oxygen is due to its conversion to superoxide.

Superoxide is formed when reduced flavins—present, for example, in xanthine oxidase—are reoxidized univalently by molecular oxygen:

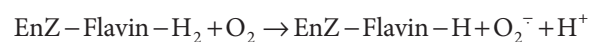

Superoxide can reduce oxidized cytochrome c

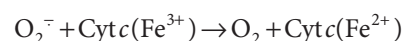

or be removed by superoxide dismutase, which catalyzes the conversion of O_2^- to oxygen and hydrogen peroxide.

In this reaction, superoxide acts as both oxidant and reductant. Thus, superoxide dismutase protects aerobic organisms

against the potential deleterious effects of superoxide. The enzyme occurs in all major aerobic tissues in the mitochondria and the cytosol. Although exposure of animals to an atmosphere of 100% oxygen causes an adaptive increase in SOD, particularly in the lungs, prolonged exposure leads to lung damage and death. Antioxidants, eg, α -tocopherol (vitamin E), act as scavengers of free radicals and reduce the toxicity of oxygen (see Chapter 44).

SUMMARY

- In biologic systems, as in chemical systems, oxidation (loss of electrons) is always accompanied by reduction of an electron acceptor.
- Oxidoreductases have a variety of functions in metabolism; oxidases and dehydrogenases play major roles in respiration; hydroperoxidases protect the body against damage by free radicals; and oxygenases mediate the hydroxylation of drugs and steroids.

- Tissues are protected from oxygen toxicity caused by the superoxide free radical by the specific enzyme superoxide dismutase.

REFERENCES

- Babcock GT, Wikstrom M: Oxygen activation and the conservation of energy in cell respiration. *Nature* 1992;356:301.
- Coon MJ: Cytochrome P450: Nature's most versatile biological catalyst. *Annu Rev Pharmacol Toxicol* 2005;4:1.
- Dickinson BC, Chang CJ: Chemistry and biology of reactive oxygen species in signaling or stress responses. *Nature Chem Biol* 2011;7:504.
- Harris DA: *Bioenergetics at a Glance: An Illustrated Introduction*. Blackwell Publishing, 1995.
- Johnson F, Giulivi C: Superoxide dismutases and their impact upon human health. *Mol Aspects Med* 2005;26.
- Nicholls DG, Ferguson SJ: *Bioenergetics*, 4th ed. Elsevier, 2013.

The Respiratory Chain & Oxidative Phosphorylation

Kathleen M. Botham, PhD, DSc & Peter A. Mayes, PhD, DSc

OBJECTIVES

After studying this chapter, you should be able to:

- Describe the double membrane structure of mitochondria and indicate the location of various enzymes.
- Appreciate that energy from the oxidation of fuel substrates (fats, carbohydrates, amino acids) is almost all liberated in mitochondria as reducing equivalents, which are passed by a process termed electron transport through a series of redox carriers or complexes embedded in the inner mitochondrial membrane known as the respiratory chain until they are finally reacted with oxygen to form water.
- Describe the four protein complexes involved in the transfer of electrons through the respiratory chain and explain the roles of flavoproteins, iron sulfur proteins, and coenzyme Q.
- Understand how coenzyme Q accepts electrons from NADH via Complex I and from FADH₂ via Complex II.
- Indicate how electrons are passed from reduced coenzyme Q to cytochrome c via Complex III in the Q cycle.
- Explain the process by which reduced cytochrome c is oxidized and oxygen is reduced to water via Complex IV.
- Understand how electron transport through the respiratory chain generates a proton gradient across the inner mitochondrial membrane, leading to the buildup of a proton motive force that generates ATP by the process of oxidative phosphorylation.
- Describe the structure of the ATP synthase enzyme and explain how it works as a rotary motor to produce ATP from ADP and Pi.
- Identify the five conditions controlling the rate of respiration in mitochondria and understand that oxidation of reducing equivalents via the respiratory chain and oxidative phosphorylation are tightly coupled in most circumstances, so that one cannot proceed unless the other is functioning.
- Indicate examples of common poisons that block respiration or oxidative phosphorylation and identify their site of action.
- Explain, with examples, how uncouplers may act as poisons by dissociating oxidation via the respiratory chain from oxidative phosphorylation, but may also have a physiological role in generating body heat.
- Explain the role of exchange transporters present in the inner mitochondrial membrane in allowing ions and metabolites to pass through while preserving electrochemical and osmotic equilibrium.

BIOMEDICAL IMPORTANCE

Aerobic organisms are able to capture a far greater proportion of the available free energy of respiratory substrates than anaerobic organisms. Most of this takes place inside **mitochondria**, which have been termed the “powerhouses” of the cell. Respiration is coupled to the generation of the high-energy intermediate, ATP (see Chapter 11), by **oxidative phosphorylation**. A number of drugs (eg, **amobarbital**) and poisons (eg, **cyanide**, **carbon monoxide**) inhibit oxidative phosphorylation, usually with fatal consequences. Several inherited defects of mitochondria involving components of the respiratory chain and oxidative phosphorylation have been reported. Patients present with **myopathy** and **encephalopathy** and often have **lactic acidosis**.

SPECIFIC ENZYMES ARE ASSOCIATED WITH COMPARTMENTS SEPARATED BY THE MITOCHONDRIAL MEMBRANES

The Mitochondrial **matrix** is enclosed by a **double membrane**. The **outer membrane** is permeable to most metabolites and the **inner membrane** is selectively permeable (Figure 13–1). The outer membrane is characterized by the presence of various enzymes, including **acyl-CoA synthetase** and **glycerolphosphate acyltransferase**. Other enzymes, including **adenylyl kinase** and **creatine kinase** are found in the **intermembrane space**. The phospholipid **cardiolipin** is concentrated in the

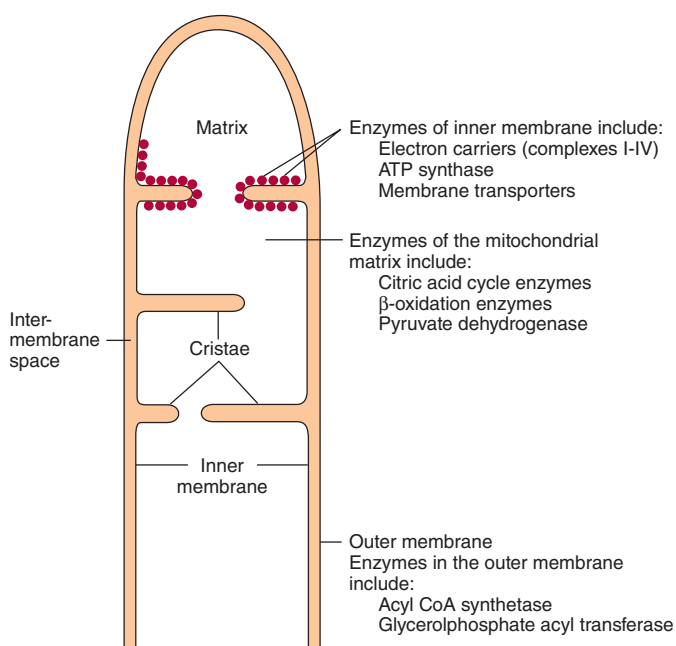

FIGURE 13–1 Structure of the mitochondrial membranes. Note that the inner membrane contains many folds or cristae.

inner membrane together with the enzymes of the **respiratory chain**, **ATP synthase**, and various **membrane transporters**.

THE RESPIRATORY CHAIN OXIDIZES REDUCING EQUIVALENTS & ACTS AS A PROTON PUMP

Most of the energy liberated during the oxidation of carbohydrate, fatty acids, and amino acids is made available within mitochondria as reducing equivalents (—H or electrons) (Figure 13–2). The enzymes of the citric acid cycle and β -oxidation (see Chapters 22 and 16), the **respiratory chain complexes**, and the machinery for **oxidative phosphorylation** are all found in mitochondria. The respiratory chain collects and transports reducing equivalents, directing them to their final reaction with oxygen to form water, and oxidative phosphorylation is the process by which the liberated free energy is trapped as **high-energy phosphate**.

Components of the Respiratory Chain Are Contained in Four Large Protein Complexes Embedded in the Inner Mitochondrial Membrane

Electrons flow through the respiratory chain through a redox span of 1.1 V from NAD^+/NADH to $\text{O}_2/2\text{H}_2\text{O}$ (see Table 12–1), passing through three large protein complexes: **NADH-Q oxidoreductase (Complex I)**, where electrons are transferred from NADH to **coenzyme Q (Q)** (also called **ubiquinone**) (Figure 13–6); **Q-cytochrome c oxidoreductase (Complex III)**, which passes the electrons on to **cytochrome c**; and **cytochrome c oxidase (Complex IV)**, which completes the chain, passing the electrons to O_2 and causing it to be reduced to H_2O (Figure 13–3). Some substrates with more positive redox potentials than NAD^+/NADH (eg, succinate) pass electrons to Q via a fourth complex, **succinate-Q reductase (Complex II)**, rather than Complex I. The four complexes are embedded in the inner mitochondrial membrane, but Q and cytochrome c are mobile. Q diffuses rapidly within the membrane, while cytochrome c is a soluble protein. The flow of electrons through Complexes I, III, and IV results in the pumping of protons from the matrix across the inner mitochondrial membrane into the intermembrane space (Figure 13–7).

Flavoproteins & Iron-Sulfur Proteins (Fe-S) Are Components of the Respiratory Chain Complexes

Flavoproteins (see Chapter 12) are important components of Complexes I and II. The oxidized flavin nucleotide (FMN or FAD) can be reduced in reactions involving the transfer of two electrons (to form FMNH_2 or FADH_2), but they can also accept

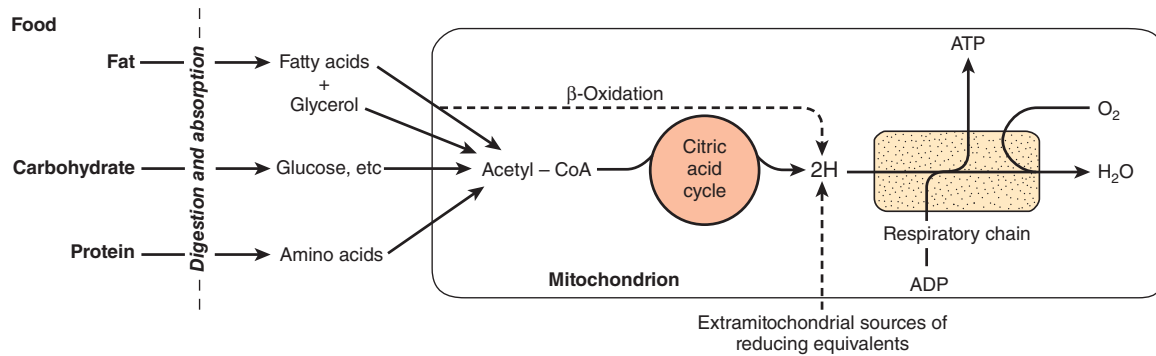

FIGURE 13-2 Role of the respiratory chain of mitochondria in the conversion of food energy to ATP.

Oxidation of the major foodstuffs leads to the generation of reducing equivalents (2H) that are collected by the respiratory chain for oxidation and coupled generation of ATP.

one electron to form the semiquinone (see Figure 12-2). **Iron-sulfur proteins (nonheme iron proteins, Fe-S)** are found in Complexes I, II, and III. These may contain one, two, or four Fe atoms linked to inorganic sulfur atoms and/or via cysteine-SH groups to the protein (Figure 13-4). The Fe-S take part in single electron transfer reactions in which one Fe atom undergoes oxidoreduction between Fe²⁺ and Fe³⁺.

Q Accepts Electrons via Complexes I & II

NADH-Q oxidoreductase or Complex I is a large L-shaped multisubunit protein that catalyzes electron transfer from NADH to Q, coupled with the transfer of four H⁺ across the membrane:



Electrons are transferred from NADH to FMN initially, then to a series of Fe-S centers, and finally to Q (Figure 13-5). In Complex II (succinate-Q reductase), FADH₂ is formed during

the conversion of succinate to fumarate in the citric acid cycle (see Figure 16-3) and electrons are then passed via several Fe-S centers to Q (Figure 13-5). Glycerol-3-phosphate (generated in the breakdown of triacylglycerols or from glycolysis, Figure 17-2) and acyl-CoA also pass electrons to Q via different pathways involving flavoproteins (Figure 13-5).

The Q Cycle Couples Electron Transfer to Proton Transport in Complex III

Electrons are passed from QH₂ to cytochrome *c* via Complex III (Q-cytochrome *c* oxidoreductase):

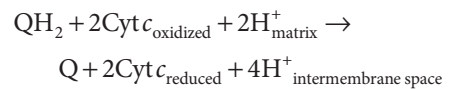

The process is believed to involve **cytochromes *c*₁, *b*_L, and *b*_H** and a **Rieske Fe-S** (an unusual Fe-S in which one of the Fe atoms is linked to two histidine residues rather than two

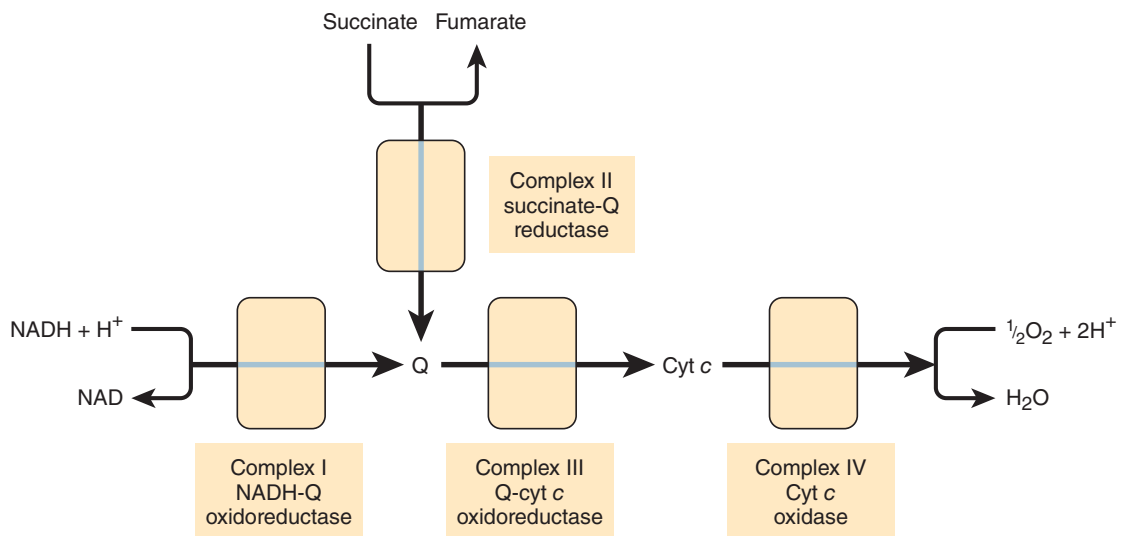

FIGURE 13-3 Overview of electron flow through the respiratory chain. (cyt, cytochrome; Q, coenzyme Q or ubiquinone.)

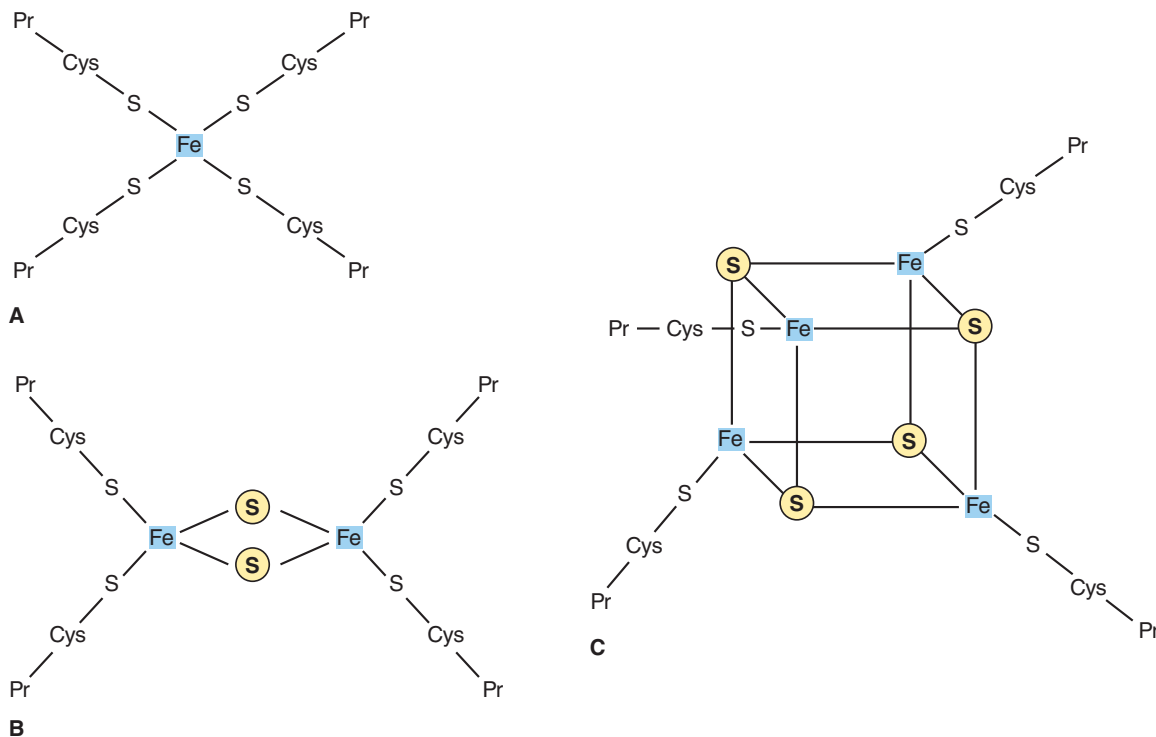

FIGURE 13-4 Iron-sulfur proteins (Fe-S). (A) The simplest Fe-S with one Fe bound by four cysteines. (B) 2Fe-2S center. (C) 4Fe-4S center. (Cys, cysteine; Pr, apoprotein; S, Inorganic sulfur.)

cysteine residues) (Figure 13-5) and is known as the **Q cycle** (Figure 13-6). Q may exist in three forms: the oxidized quinone, the reduced quinol, or the semiquinone (Figure 13-6). The semiquinone is formed transiently during the cycle, one turn of which results in the oxidation of 2QH₂ to Q, releasing 4H⁺ into

the intermembrane space, and the reduction of one Q to QH₂, causing 2H⁺ to be taken up from the matrix (Figure 13-6). Note that while Q carries two electrons, the cytochromes carry only one, thus the oxidation of one QH₂ is coupled to the reduction of two molecules of cytochrome *c* via the Q cycle.

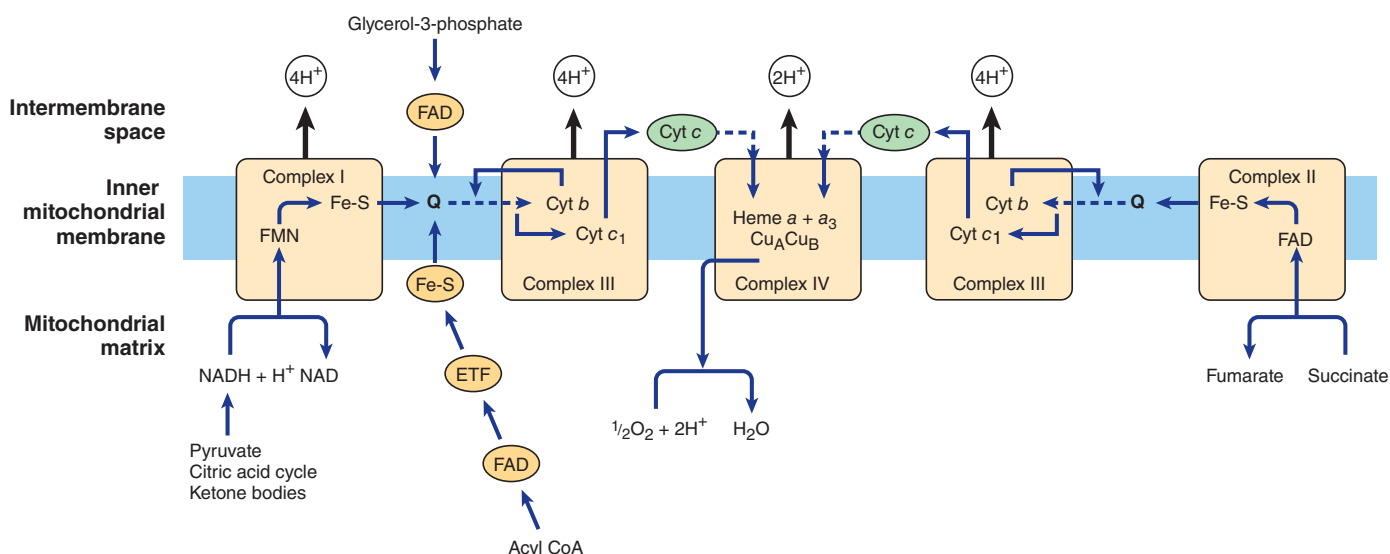

FIGURE 13-5 Flow of electrons through the respiratory chain complexes, showing the entry points for reducing equivalents from important substrates. Q and cyt *c* are mobile components of the system as indicated by the dotted arrows. The flow through Complex III (the Q cycle) is shown in more detail in Figure 13-6. (cyt, cytochrome; ETF, electron transferring flavoprotein; Fe-S, iron-sulfur protein; Q, coenzyme Q or ubiquinone.)

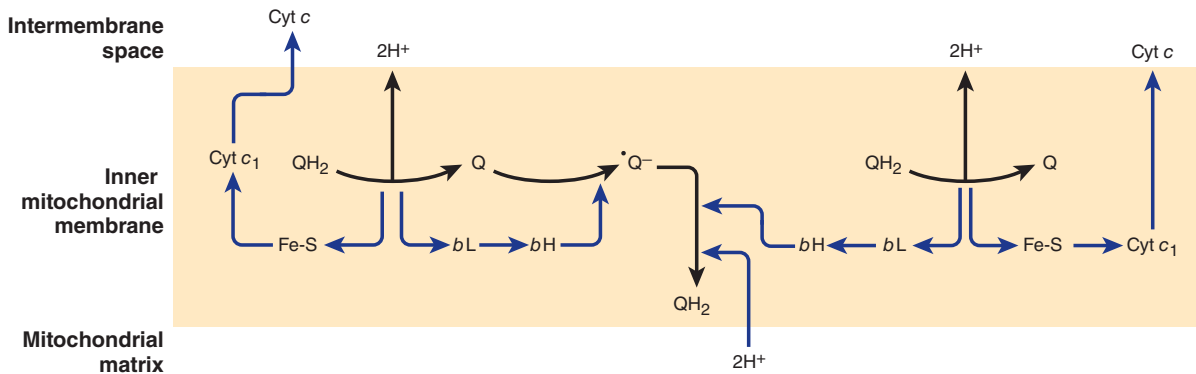
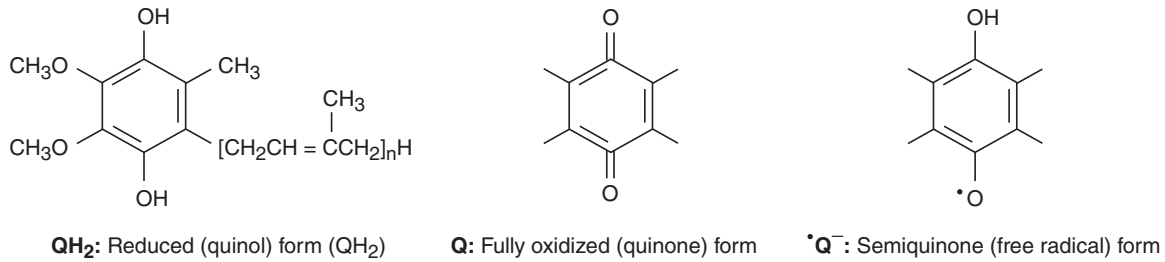
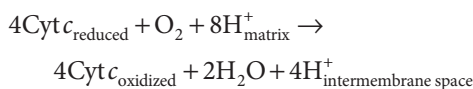

FIGURE 13-6 The Q cycle. During the oxidation of QH₂ to Q, one electron is donated to cyt *c* via a Rieske Fe-S and cyt *c*₁, and the second to a Q to form the semiquinone via cyt *b*_L and cyt *b*_H, with 2H⁺ being released into the intermembrane space. A similar process then occurs with a second QH₂, but in this case the second electron is donated to the semiquinone, reducing it to QH₂, and 2H⁺ are taken up from the matrix. (cyt, cytochrome; Fe-S, iron-sulfur protein; Q, coenzyme Q or ubiquinone.)

Molecular Oxygen Is Reduced to Water via Complex IV

Reduced cytochrome *c* is oxidized by Complex IV (cytochrome *c* oxidase), with the concomitant reduction of O₂ to two molecules of water:



This transfer of four electrons from cytochrome *c* to O₂ involves **two heme groups, *a* and *a*₃**, and **Cu** (Figure 13-5). Electrons are passed initially to a Cu center (Cu_A), which contains 2Cu atoms linked to two protein cysteine-SH groups (resembling an Fe-S), then in sequence to heme *a*, heme *a*₃, a second Cu center, Cu_B, which is linked to heme *a*₃, and finally to O₂. Of the eight H⁺ removed from the matrix, four are used to form two water molecules and four are pumped into the intermembrane space. Thus, for every pair of electrons passing down the chain from NADH or FADH₂, 2H⁺ are pumped across the membrane by Complex IV. The O₂ remains tightly bound to Complex IV until it is fully reduced, and this minimizes the release of potentially damaging intermediates such as superoxide anions or peroxide which are formed when O₂ accepts one or two electrons, respectively (see Chapter 12).

ELECTRON TRANSPORT VIA THE RESPIRATORY CHAIN CREATES A PROTON GRADIENT WHICH DRIVES THE SYNTHESIS OF ATP

The flow of electrons through the respiratory chain generates ATP by the process of **oxidative phosphorylation**. The **chemiosmotic theory**, proposed by Peter Mitchell in 1961, postulates that the two processes are coupled by a proton gradient across the inner mitochondrial membrane so that **the proton motive force** caused by the electrochemical potential difference (negative on the matrix side) drives the mechanism of ATP synthesis. As we have seen, Complexes I, III, and IV act as **proton pumps**. Since the inner mitochondrial membrane is impermeable to ions in general and particularly to protons, these accumulate in the intermembrane space, creating the proton motive force predicted by the chemiosmotic theory.

A Membrane-Located ATP Synthase Functions as a Rotary Motor to Form ATP

The proton motive force drives a membrane-located **ATP synthase** that forms ATP in the presence of P_i + ADP. ATP synthase is embedded in the inner membrane, together with the respiratory chain complexes (Figure 13-7). Several subunits of the protein form a ball-like shape arranged around an axis known as F₁, which projects into the matrix and contains

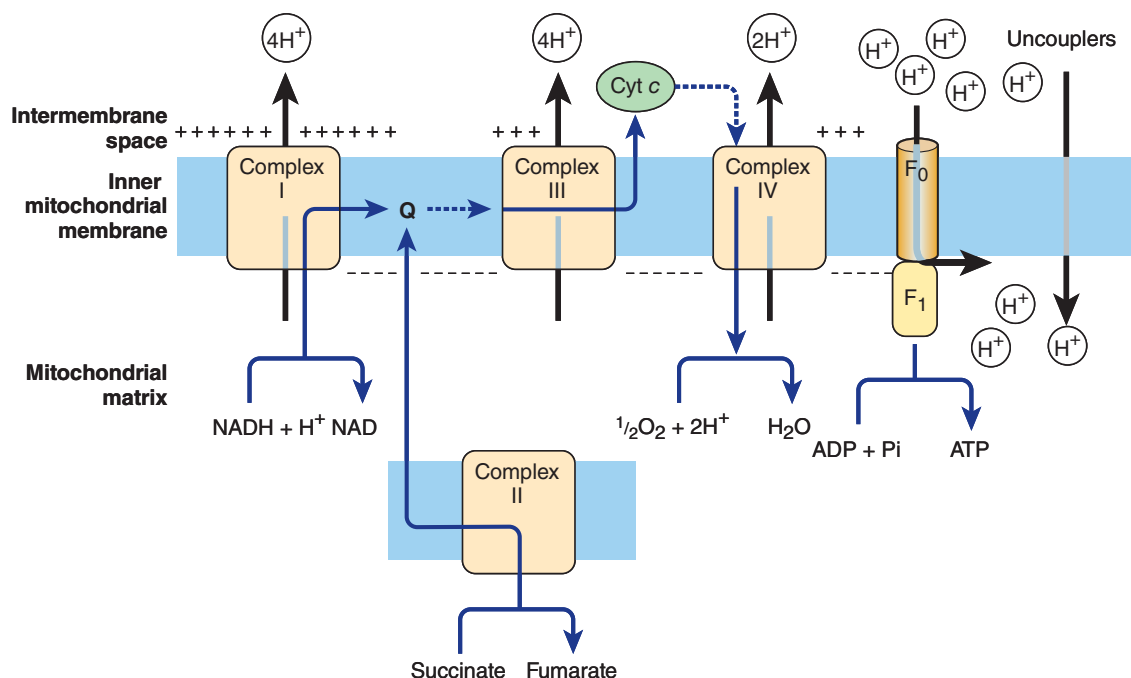

FIGURE 13-7 The chemiosmotic theory of oxidative phosphorylation. Complexes I, III, and IV act as proton pumps creating a proton gradient across the membrane, which is negative on the matrix side. The proton motive force generated drives the synthesis of ATP as the protons flow back into the matrix through the ATP synthase enzyme (see Figure 13-8). Uncouplers increase the permeability of the membrane to ions, collapsing the proton gradient by allowing the H^+ to pass across without going through the ATP synthase, and thus uncouple electron flow through the respiratory complexes from ATP synthesis. (cyt, cytochrome; Q, coenzyme Q or ubiquinone.)

the phosphorylation mechanism (Figure 13-8). F_1 is attached to a membrane protein complex known as F_0 , which also consists of several protein subunits. F_0 spans the membrane and forms a proton channel. The flow of protons through F_0 causes it to rotate, driving the production of ATP in the F_1 complex (Figures 13-7 and 13-8). This is thought to occur by a **binding change mechanism** in which the conformation of the β -subunits in F_1 is changed as the axis rotates from one that binds ATP tightly to one that releases ATP and binds ADP and P_i so that the next ATP can be formed. Estimates suggest that for each NADH oxidized, Complexes I and III translocate four protons each and Complex IV translocates two.

THE RESPIRATORY CHAIN PROVIDES MOST OF THE ENERGY CAPTURED DURING CATABOLISM

ADP captures, in the form of high-energy phosphate, a significant proportion of the free energy released by catabolic processes. The resulting ATP has been called the **energy “currency”** of the cell because it passes on this free energy to drive those processes requiring energy (see Figure 11-6).

There is a net direct capture of two high-energy phosphate groups in the glycolytic reactions (see Table 17-1). Two more

high-energy phosphates per mole of glucose are captured in the citric acid cycle during the conversion of succinyl CoA to succinate (see Chapter 16). All of these phosphorylations occur at the **substrate level**. For each mol of substrate oxidized via Complexes I, III, and IV in the respiratory chain (ie, via NADH), 2.5 mol of ATP are formed per 0.5 mol of O_2 consumed; ie, the P:O ratio = 2.5 (Figure 13-7). On the other hand, when 1 mol of substrate (eg, succinate or 3-phosphoglycerate) is oxidized via Complexes II, III, and IV, only 1.5 mol of ATP are formed; that is, P:O = 1.5. These reactions are known as **oxidative phosphorylation at the respiratory chain level**. Taking these values into account, it can be estimated that nearly 90% of the high-energy phosphates produced from the complete oxidation of 1 mol glucose is obtained via oxidative phosphorylation coupled to the respiratory chain (see Table 17-1).

Respiratory Control Ensures a Constant Supply of ATP

The rate of respiration of mitochondria can be controlled by the availability of ADP. This is because oxidation and phosphorylation are **tightly coupled**; that is, oxidation cannot proceed via the respiratory chain without concomitant phosphorylation of ADP. **Table 13-1** shows the five conditions controlling the rate of respiration in mitochondria. Most cells in the resting state are in **state 4**, and respiration is controlled by the availability of ADP. When work is performed, ATP is converted to ADP, allowing more respiration to occur, which

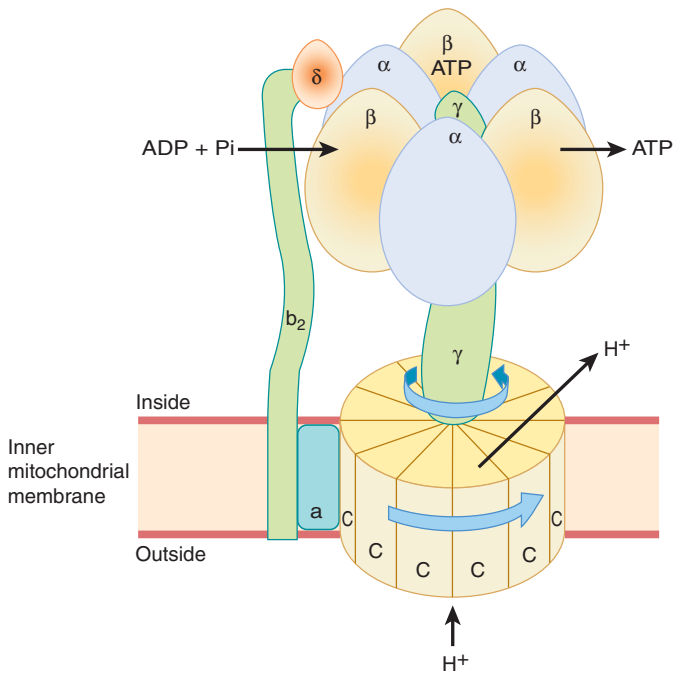

FIGURE 13-8 Mechanism of ATP production by ATP synthase. The enzyme complex consists of an F_0 subcomplex which is a disk of “C” protein subunits. Attached is a γ subunit in the form of a “bent axle.” Protons passing through the disk of “C” units cause it and the attached γ subunit to rotate. The γ subunit fits inside the F_1 subcomplex of three α and three β subunits, which are fixed to the membrane and do not rotate. ADP and P_i are taken up sequentially by the β subunits to form ATP, which is expelled as the rotating γ subunit squeezes each β subunit in turn and changes its conformation. Thus, three ATP molecules are generated per revolution. For clarity, not all the subunits that have been identified are shown—eg, the “axle” also contains an ϵ subunit.

in turn replenishes the store of ATP. Under certain conditions, the concentration of inorganic phosphate can also affect the rate of functioning of the respiratory chain. As respiration increases (as in exercise), the cell approaches **state 3 or 5** when either the capacity of the respiratory chain becomes saturated or the PO_2 decreases below the K_m for heme a_3 . There is also the possibility that the ADP/ATP transporter, which facilitates entry of cytosolic ADP into and ATP out of the mitochondrion, becomes rate limiting.

Thus, the manner in which biologic oxidative processes allow the free energy resulting from the oxidation of foodstuffs

to become available and to be captured is stepwise, efficient, and controlled—rather than explosive, inefficient, and uncontrolled, as in many nonbiologic processes. The remaining free energy that is not captured as high-energy phosphate is liberated as **heat**. This need not to be considered “wasted” since it ensures that the respiratory system as a whole is sufficiently exergonic to be removed from equilibrium, allowing continuous unidirectional flow and constant provision of ATP. It also contributes to maintenance of body temperature.

MANY POISONS INHIBIT THE RESPIRATORY CHAIN

Much information about the respiratory chain has been obtained by the use of inhibitors, and, conversely, this has provided knowledge about the mechanism of action of several poisons (**Figure 13-9**). They may be classified as inhibitors of the respiratory chain, inhibitors of oxidative phosphorylation, or uncouplers of oxidative phosphorylation.

Barbiturates such as amobarbital inhibit electron transport via Complex I by blocking the transfer from Fe-S to Q. At sufficient dosage, they are fatal in vivo. **Antimycin A** and **dimercaprol** inhibit the respiratory chain at Complex III. The classic poisons **H_2S** , **carbon monoxide**, and **cyanide** inhibit Complex IV and can therefore totally arrest respiration. **Malonate** is a competitive inhibitor of Complex II.

Atractyloside inhibits oxidative phosphorylation by inhibiting the transporter of ADP into and ATP out of the mitochondrion (**Figure 13-10**). The antibiotic **oligomycin** completely blocks oxidation and phosphorylation by blocking the flow of protons through ATP synthase (**Figure 13-9**).

Uncouplers dissociate oxidation in the respiratory chain from phosphorylation (**Figure 13-7**). These compounds are toxic in vivo, causing respiration to become uncontrolled, since the rate is no longer limited by the concentration of ADP or P_i . The uncoupler that has been used most frequently is **2,4-dinitrophenol**, but other compounds act in a similar manner. **Thermogenin (or the uncoupling protein)** is a physiological uncoupler found in brown adipose tissue that functions to generate body heat, particularly for the newborn and during hibernation in animals (see Chapter 25).

THE CHEMIOSMOTIC THEORY CAN ACCOUNT FOR RESPIRATORY CONTROL AND THE ACTION OF UNCOUPLERS

The electrochemical potential difference across the membrane, once established as a result of proton translocation, inhibits further transport of reducing equivalents through the respiratory chain unless discharged by back-translocation of protons across the membrane through the ATP synthase. This in turn depends on availability of ADP and P_i .

TABLE 13-1 States of Respiratory Control

Conditions Limiting the Rate of Respiration	
State 1	Availability of ADP and substrate
State 2	Availability of substrate only
State 3	The capacity of the respiratory chain itself, when all substrates and components are present in saturating amounts
State 4	Availability of ADP only
State 5	Availability of oxygen only

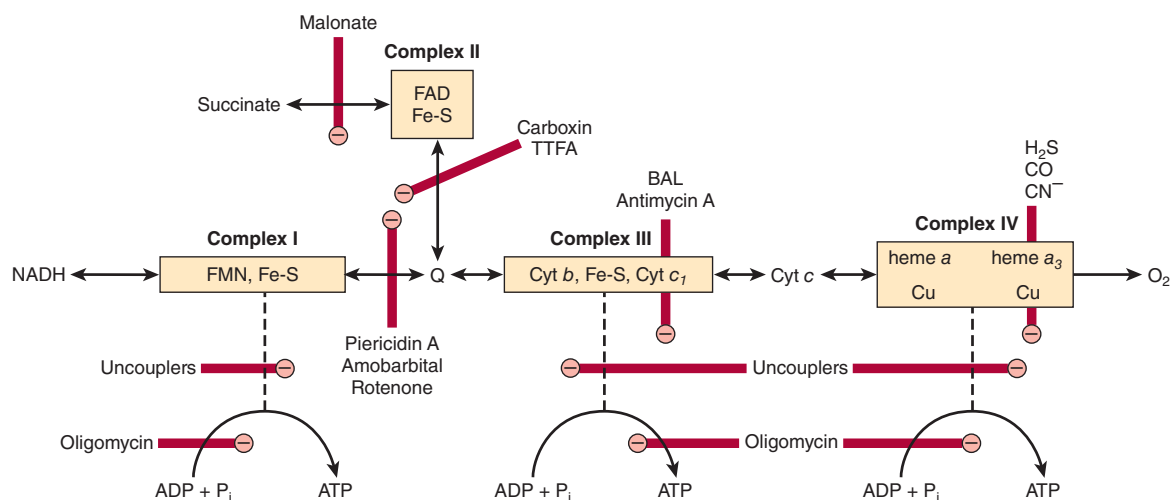

FIGURE 13-9 Sites of inhibition (⊖) of the respiratory chain by specific drugs, chemicals, and antibiotics. (BAL, dimercaprol; TTFA, an Fe-chelating agent. Other abbreviations as in Figure 13-5.)

Uncouplers (eg, dinitrophenol) are amphipathic (see Chapter 21) and increase the permeability of the lipid

inner mitochondrial membrane to protons, thus reducing the electrochemical potential and short-circuiting the ATP synthase (Figure 13-7). In this way, oxidation can proceed without phosphorylation.

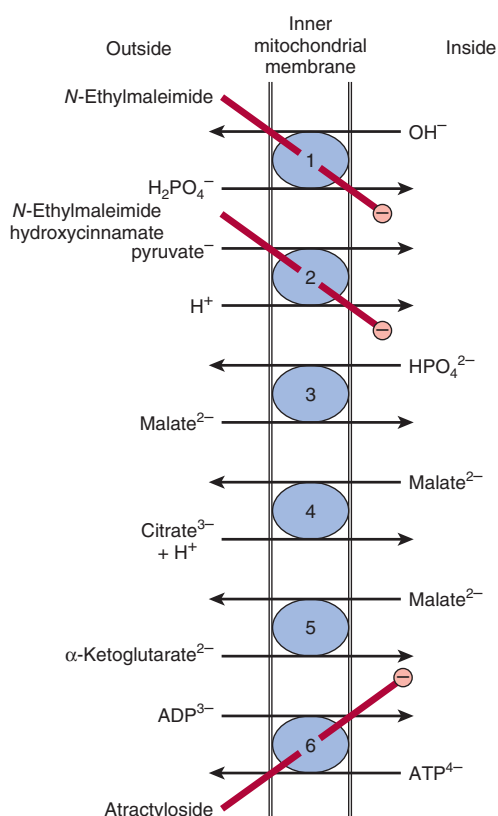

FIGURE 13-10 Transporter systems in the inner mitochondrial membrane. ① Phosphate transporter, ② pyruvate symport, ③ dicarboxylate transporter, ④ tricarboxylate transporter, ⑤ α-ketoglutarate transporter, ⑥ adenine nucleotide transporter. *N*-Ethylmaleimide, hydroxycinnamate, and atractyloside inhibit (⊖) the indicated systems. Also present (but not shown) are transporter systems for glutamate/aspartate (Figure 13-13), glutamine, ornithine, neutral amino acids, and carnitine (see Figure 22-1).

THE SELECTIVE PERMEABILITY OF THE INNER MITOCHONDRIAL MEMBRANE NECESSITATES EXCHANGE TRANSPORTERS

Exchange diffusion systems involving transporter proteins that span the membrane are present in the membrane for exchange of anions against OH⁻ ions and cations against H⁺ ions. Such systems are necessary for uptake and output of ionized metabolites while preserving electrical and osmotic equilibrium. The inner mitochondrial membrane is freely permeable to **uncharged small molecules**, such as oxygen, water, CO₂, NH₃, and to **monocarboxylic acids**, such as 3-hydroxybutyric, acetoacetic, and acetic, especially in their undissociated, more lipid soluble form. **Long-chain fatty acids** are transported into mitochondria via the carnitine system (see Figure 22-1), and there is also a special carrier for **pyruvate** involving a symport that utilizes the H⁺ gradient from outside to inside the mitochondrion (Figure 13-10). However, **dicarboxylate and tricarboxylate anions** (eg, malate, citrate) and **amino acids** require specific transporter or carrier systems to facilitate their passage across the membrane.

The transport of di- and tricarboxylate anions is closely linked to that of inorganic phosphate, which penetrates readily as the H₂PO₄⁻ ion in exchange for OH⁻. The net uptake of malate by the dicarboxylate transporter requires inorganic phosphate for exchange in the opposite direction. The net uptake of citrate, isocitrate, or *cis*-aconitate by the tricarboxylate transporter requires malate in exchange. α-Ketoglutarate transport also

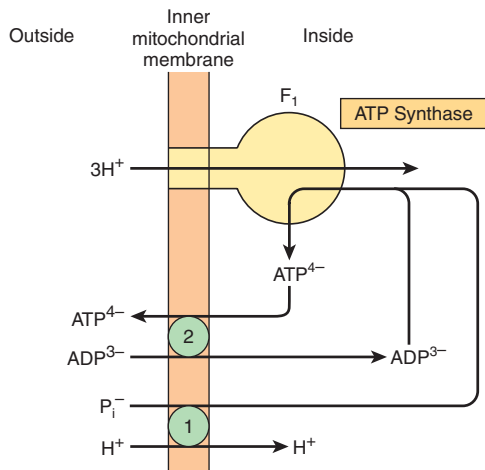

FIGURE 13-11 Combination of phosphate transporter ① with the adenine nucleotide transporter ② in ATP synthesis. The H^+/P_i symport shown is equivalent to the P_i/OH^- antiport shown in Figure 13-10.

requires an exchange with malate. The adenine nucleotide transporter allows the exchange of ATP and ADP, but not AMP. It is vital for ATP exit from mitochondria to the sites of extramitochondrial utilization and for the return of ADP for ATP production within the mitochondrion (Figure 13-11). Since in this translocation four negative charges are removed from the matrix for every three taken in, the electrochemical gradient across the membrane (the proton motive force) favors the export of ATP. Na^+ can be exchanged for H^+ , driven by the proton gradient. It is believed that active uptake of Ca^{2+} by mitochondria occurs with a net charge transfer of 1 (Ca^{2+} uniport), possibly through a Ca^{2+}/H^+ antiport. Calcium release from mitochondria is facilitated by exchange with Na^+ .

Ionophores Permit Specific Cations to Penetrate Membranes

Ionophores are lipophilic molecules that complex specific cations and facilitate their transport through biologic membranes,

for example, **valinomycin** (K^+). The classic uncouplers such as dinitrophenol are, in fact, proton ionophores.

A Proton-Translocating Transhydrogenase Is a Source of Intramitochondrial NADPH

Energy-linked transhydrogenase, a protein in the inner mitochondrial membrane, couples the passage of protons down the electrochemical gradient from outside to inside the mitochondrion with the transfer of H from intramitochondrial NADH to NADPH for intramitochondrial enzymes such as glutamate dehydrogenase and hydroxylases involved in steroid synthesis.

Oxidation of Extramitochondrial NADH Is Mediated by Substrate Shuttles

NADH cannot penetrate the mitochondrial membrane, but it is produced continuously in the cytosol by 3-phosphoglycerate dehydrogenase, an enzyme in the glycolysis sequence (see Figure 17-2). However, under aerobic conditions, extramitochondrial NADH does not accumulate and is presumed to be oxidized by the respiratory chain in mitochondria. The transfer of reducing equivalents through the mitochondrial membrane requires **substrate pairs**, linked by suitable dehydrogenases on each side of the mitochondrial membrane. The mechanism of transfer using the **glycerophosphate shuttle** is shown in Figure 13-12. Since the mitochondrial enzyme is linked to the respiratory chain via a flavoprotein rather than NAD, only 1.5 mol rather than 2.5 mol of ATP are formed per atom of oxygen consumed. Although this shuttle is present in some tissues (eg, brain, white muscle), in others (eg, heart muscle) it is deficient. It is therefore believed that the **malate shuttle** system (Figure 13-13) is of more universal utility. The complexity of this system is due to the impermeability of the mitochondrial membrane to oxaloacetate, which must react with glutamate to form aspartate and α -ketoglutarate by transamination before transport through the mitochondrial membrane and reconstitution to oxaloacetate in the cytosol.

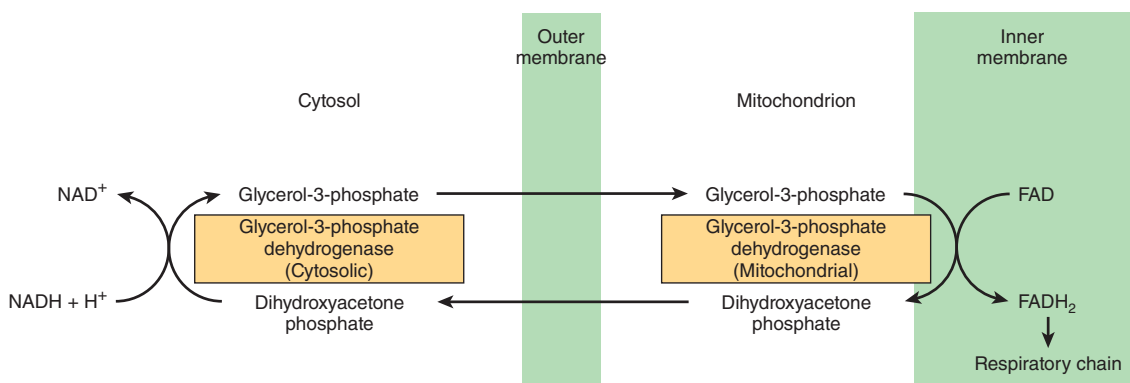

FIGURE 13-12 Glycerophosphate shuttle for transfer of reducing equivalents from the cytosol into the mitochondrion.

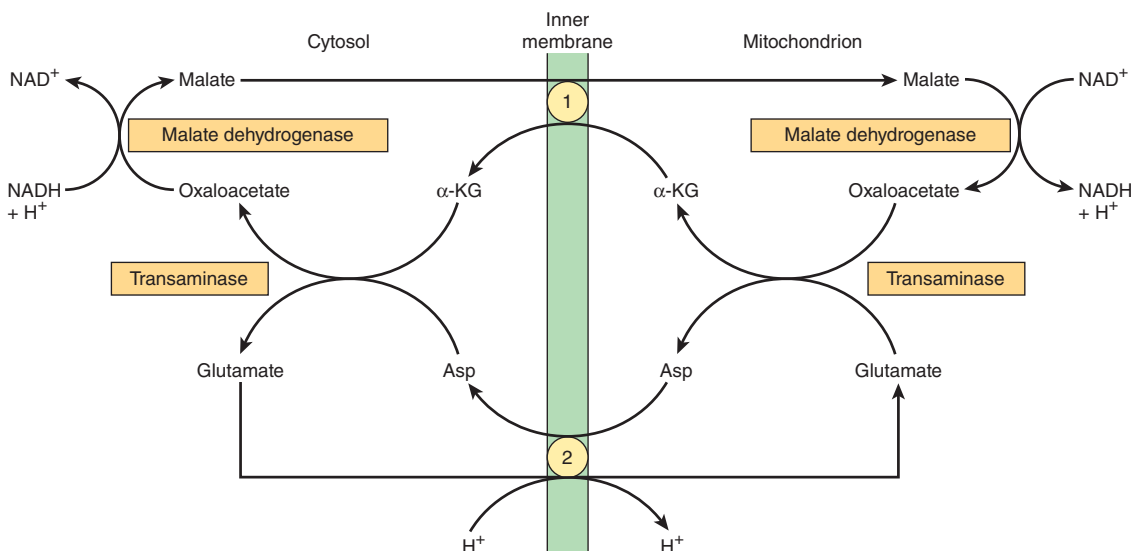

FIGURE 13-13 Malate shuttle for transfer of reducing equivalents from the cytosol into the mitochondrion. ① α -Ketoglutarate transporter and ② glutamate/aspartate transporter (note the proton symport with glutamate).

Ion Transport in Mitochondria Is Energy Linked

Mitochondria maintain or accumulate cations such as K^+ , Na^+ , Ca^{2+} , and Mg^{2+} , and P_i . It is assumed that a primary proton pump drives cation exchange.

The Creatine Phosphate Shuttle Facilitates Transport of High-Energy Phosphate from Mitochondria

The **creatine phosphate shuttle** (Figure 13-14) augments the functions of **creatine phosphate** as an energy buffer by acting as a dynamic system for transfer of high-energy phosphate from mitochondria in active tissues such as heart and skeletal muscle. An isoenzyme of **creatine kinase** (CK_m) is found in the mitochondrial intermembrane space, catalyzing the transfer of high-energy phosphate to creatine from ATP emerging from the adenine nucleotide transporter. In turn, the creatine phosphate is transported into the cytosol via protein pores in the outer mitochondrial membrane, becoming available for generation of extramitochondrial ATP.

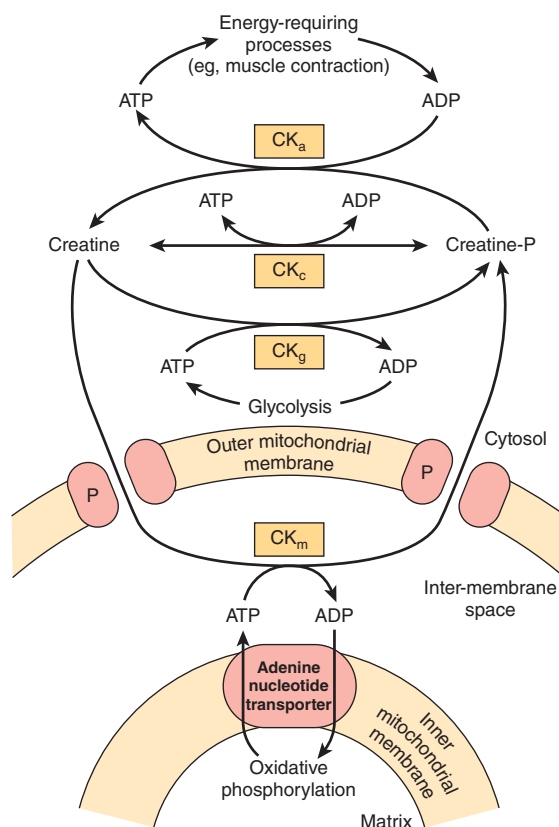

FIGURE 13-14 The creatine phosphate shuttle of heart and skeletal muscle. The shuttle allows rapid transport of high-energy phosphate from the mitochondrial matrix into the cytosol. (CK_a , creatine kinase concerned with large requirements for ATP, eg, muscular contraction; CK_c , creatine kinase for maintaining equilibrium between creatine and creatine phosphate and ATP/ADP; CK_g , creatine kinase coupling glycolysis to creatine phosphate synthesis; CK_m , mitochondrial creatine kinase mediating creatine phosphate production from ATP formed in oxidative phosphorylation; P, pore protein in outer mitochondrial membrane.)

CLINICAL ASPECTS

The condition known as **fatal infantile mitochondrial myopathy and renal dysfunction** involves severe diminution or absence of most oxidoreductases of the respiratory chain. **MELAS** (mitochondrial encephalopathy, lactic acidosis, and stroke) is an inherited condition due to NADH-Q oxidoreductase (Complex I) or cytochrome oxidase (Complex IV) deficiency. It is caused by a mutation in mitochondrial DNA and may be involved in **Alzheimer disease** and **diabetes mellitus**. A number of drugs and poisons act by inhibition of oxidative phosphorylation (see above).

SUMMARY

- Virtually all energy released from the oxidation of carbohydrate, fat, and protein is made available in mitochondria as reducing equivalents (—H or e^-). These are funneled into the respiratory chain, where they are passed down a redox gradient of carriers to their final reaction with oxygen to form water.
- The redox carriers are grouped into four respiratory chain complexes in the inner mitochondrial membrane. Three of the four complexes are able to use the energy released in the redox gradient to pump protons to the outside of the membrane, creating an electrochemical potential between the matrix and the inner membrane space.
- ATP synthase spans the membrane and acts like a rotary motor using the potential energy of the proton gradient or proton motive force to synthesize ATP from ADP and P_i . In this way, oxidation is closely coupled to phosphorylation to meet the energy needs of the cell.
- Since the inner mitochondrial membrane is impermeable to protons and other ions, special exchange transporters span the membrane to allow ions such as OH^- , ATP^{4-} , ADP^{3-} , and metabolites to pass through without discharging the electrochemical gradient across the membrane.
- Many well-known poisons such as cyanide arrest respiration by inhibition of the respiratory chain.

REFERENCES

- Hinkle PC: P/O ratios of mitochondrial oxidative phosphorylation. *Biochem Biophys Acta* 2005;1706:1.
- Kocherginsky N: Acidic lipids, H(+)-ATPases, and mechanism of oxidative phosphorylation. Physico-chemical ideas 30 years after P. Mitchell's Nobel Prize award. *Prog Biophys Mol Biol* 2009;99:20.
- Mitchell P: Keilin's respiratory chain concept and its chemiosmotic consequences. *Science* 1979;206:1148.
- Nakamoto RK, Baylis Scanlon JA, Al-Shawi MK: The rotary mechanism of the ATP synthase. *Arch Biochem Biophys* 2008;476:43.
- Smeitink J, van den Heuvel L, DiMauro S: The genetics and pathology of oxidative phosphorylation. *Nat Rev Genet* 2001;2:342.
- Tyler DD: *The Mitochondrion in Health and Disease*. VCH Publishers, 1992.
- Wallace DC: Mitochondrial DNA in aging and disease. *Sci Am* 1997;277:22.
- Yoshida M, Muneyuki E, Hisabori T: ATP synthase—a marvelous rotary engine of the cell. *Nat Rev Mol Cell Biol* 2001;2:669.

Exam Questions

Section III – Bioenergetics

- Which one of the following statements about the free energy change (ΔG) in a biochemical reaction is CORRECT?
 - If ΔG is negative, the reaction proceeds spontaneously with a loss of free energy.
 - In an exergonic reaction, ΔG is positive.
 - The standard free energy change when reactants are present in concentrations of 1.0 mol/L and the pH is 7.0 is represented as ΔG° .
 - In an endergonic reaction, ΔG is negative.
 - If ΔG is 0, the reaction is essentially irreversible.
- If the ΔG of a reaction is zero:
 - The reaction goes virtually to completion and is essentially irreversible.
 - The reaction is endergonic.
 - The reaction is exergonic.
 - The reaction proceeds only if free energy can be gained.
 - The system is at equilibrium and no net change occurs.
- ΔG° is defined as the standard free energy charge when:
 - The reactants are present in concentrations of 1.0 mol/L.
 - The reactants are present in concentrations of 1.0 mol/L at pH 7.0.
 - The reactants are present in concentrations of 1.0 mmol/L at pH 7.0.
 - The reactants are present in concentrations of 1.0 $\mu\text{mol/L}$.
 - The reactants are present in concentrations of 1.0 mol/L at pH 7.4.
- Which of the following statements about ATP is CORRECT?
 - It contains three high energy phosphate bonds.
 - It is needed in the body to drive exergonic reactions.
 - It is used as an energy store in the body.
 - It functions in the body as a complex with Mg^{2+} .
 - It is synthesized by ATP synthase in the presence of uncouplers such as UCP-1 (thermogenin).
- Which one of the following enzymes uses molecular oxygen as a hydrogen acceptor?
 - Cytochrome *c* oxidase
 - Isocitrate dehydrogenase
 - Homogentisate dioxygenase
 - Catalase
 - Superoxide dismutase
- Which one of the following statement about cytochromes is INCORRECT?
 - They are hemoproteins that take part in oxidation-reduction reactions.
 - They contain iron which oscillates between Fe^{3+} and Fe^{2+} during the reactions they participate in.
 - They act as electron carriers in the respiratory chain in mitochondria.
 - They have an important role in the hydroxylation of steroids in the endoplasmic reticulum.
 - They are all dehydrogenase enzymes.
- Which one of the following statement about cytochromes P450 is INCORRECT?
 - They are able to accept electrons from either NADH or NADPH.
 - They are found only in the endoplasmic reticulum.
 - They are monooxygenase enzymes.
 - They play a major role in drug detoxification in the liver.
 - In some reactions they work in conjunction with cytochrome *b5*.
- As one molecule of NADH is oxidized via the respiratory chain:
 - 1.5 molecules of ATP are produced in total.
 - 1 molecule of ATP is produced as electrons pass through complex IV.
 - 1 molecule of ATP is produced as electrons pass through complex II.
 - 1 molecule of ATP is produced as electrons pass through complex III.
 - 0.5 of a molecule of ATP is produced as electrons pass through complex I.
- The number of ATP molecules produced for each molecule of FADH_2 oxidized via the respiratory chain is:
 - 1
 - 2.5
 - 1.5
 - 2
 - 0.5
- A number of compounds inhibit oxidative phosphorylation—the synthesis of ATP from ADP and inorganic phosphate linked to oxidation of substrates in mitochondria. Which of the following describes the action of oligomycin?
 - It discharges the proton gradient across the mitochondrial inner membrane.
 - It discharges the proton gradient across the mitochondrial outer membrane.
 - It inhibits the electron transport chain directly by binding to one of the electron carriers in the mitochondrial inner membrane.
 - It inhibits the transport of ADP into, and ATP out of, the mitochondrial matrix.
 - It inhibits the transport of protons back into the mitochondrial matrix through ATP synthase.
- A number of compounds inhibit oxidative phosphorylation—the synthesis of ATP from ADP and inorganic phosphate linked to oxidation of substrates in mitochondria. Which of the following describes the action of an uncoupler?
 - It discharges the proton gradient across the mitochondrial inner membrane.
 - It discharges the proton gradient across the mitochondrial outer membrane.
 - It inhibits the electron transport chain directly by binding to one of the electron carriers in the mitochondrial inner membrane.
 - It inhibits the transport of ADP into, and ATP out of, the mitochondrial matrix.
 - It inhibits the transport of protons back into the mitochondrial matrix through the stalk of the primary particle.

12. A student takes some tablets she is offered at a disco, and without asking what they are she swallows them. A short time later she starts to hyperventilate, and becomes very hot. What is the most likely action of the tablets she has taken?
- An inhibitor of mitochondrial ATP synthesis
 - An inhibitor of mitochondrial electron transport
 - An inhibitor of the transport of ADP into mitochondria to be phosphorylated
 - An inhibitor of the transport of ATP out of mitochondria into the cytosol
 - An uncoupler of mitochondrial electron transport and oxidative phosphorylation
13. The flow of electrons through the respiratory chain and the production of ATP are normally tightly coupled. The processes are uncoupled by which of the following?
- Cyanide
 - Oligomycin
 - Thermogenin
 - Carbon monoxide
 - Hydrogen sulphide
14. Which of the following statements about ATP synthase is INCORRECT?
- It is located in the inner mitochondrial membrane.
 - It requires a proton motive force to form ATP in the presence of ADP and Pi.
 - ATP is produced when part of the molecule rotates.
 - One ATP molecule is formed for each full revolution of the molecule.
 - The F_1 subcomplex is fixed to the membrane and does not rotate.
15. The chemiosmotic theory of Peter Mitchell proposes a mechanism for the tight coupling of electron transport via the respiratory chain to the process of oxidative phosphorylation. Which of the following options is NOT predicted by the theory?
- A proton gradient across the inner mitochondrial membrane generated by electron transport drives ATP synthesis.
 - The electrochemical potential difference across the inner mitochondrial membrane caused by electron transport is positive on the matrix side.
 - Protons are pumped across the inner mitochondrial membrane as electrons pass down the respiratory chain.
 - An increase in the permeability of the inner mitochondrial membrane to protons uncouples the processes of electron transport and oxidative phosphorylation.
 - ATP synthesis occurs when the electrochemical potential difference across the membrane is discharged by translocation of protons back across the inner mitochondrial membrane through an ATP synthase enzyme.

Overview of Metabolism & the Provision of Metabolic Fuels

David A. Bender, PhD & Peter A. Mayes, PhD, DSc

OBJECTIVES

After studying this chapter, you should be able to:

- Explain what is meant by anabolic, catabolic, and amphibolic metabolic pathways.
- Describe in outline the metabolism of carbohydrates, lipids, and amino acids at the level of tissues and organs, and at the subcellular level, and the interconversion of metabolic fuels.
- Describe the ways in which flux of metabolites through metabolic pathways is regulated.
- Describe how a supply of metabolic fuels is provided in the fed and fasting states; the formation of metabolic fuels reserves in the fed state and their mobilization in fasting.

BIOMEDICAL IMPORTANCE

Metabolism is the term used to describe the interconversion of chemical compounds in the body, the pathways taken by individual molecules, their interrelationships, and the mechanisms that regulate the flow of metabolites through the pathways. Metabolic pathways fall into three categories. (1) **Anabolic pathways**, which are those involved in the synthesis of larger and more complex compounds from smaller precursors—for example, the synthesis of protein from amino acids and the synthesis of reserves of triacylglycerol and glycogen. Anabolic pathways are endothermic. (2) **Catabolic pathways**, which are involved in the breakdown of larger molecules, commonly involving oxidative reactions; they are exothermic, producing reducing equivalents, and, mainly via the respiratory chain (see Chapter 13), ATP. (3) **Amphibolic pathways**, which occur at the “crossroads” of metabolism, acting as links between the anabolic and catabolic pathways, for example, the citric acid cycle (see Chapter 16).

Knowledge of normal metabolism is essential for an understanding of abnormalities that underlie disease. Normal metabolism includes adaptation to periods of fasting, starvation, and

exercise, as well as pregnancy and lactation. Abnormal metabolism may result from nutritional deficiency, enzyme deficiency, abnormal secretion of hormones, or the actions of drugs and toxins.

A 70-kg adult human being requires about 8 to 12 MJ (1920-2900 kcal) from metabolic fuels each day, depending on physical activity. Larger animals require less per kilogram body weight, and smaller animals more. Growing children and animals have a proportionally higher requirement to allow for the energy cost of growth. For human beings, this energy requirement is met from carbohydrates (40%-60%), lipids (mainly triacylglycerol, 30%-40%), and protein (10%-15%), as well as alcohol. The mix of carbohydrate, lipid, and protein being oxidized varies, depending on whether the subject is in the fed or fasting state, and on the duration and intensity of physical work.

There is a constant requirement for metabolic fuels throughout the day; average physical activity increases metabolic rate only by about 40% to 50% over the basal or resting metabolic rate. However, most people consume their daily intake of metabolic fuels in two or three meals, so there is a need to form reserves of carbohydrate (glycogen in liver and

muscle), lipid (triacylglycerol in adipose tissue), and labile protein stores during the period following a meal, for use during the intervening time when there is no intake of food.

If the intake of metabolic fuels is consistently greater than energy expenditure, the surplus is stored, largely as triacylglycerol in adipose tissue, leading to the development of **obesity** and its associated health hazards. By contrast, if the intake of metabolic fuels is consistently lower than energy expenditure, there are negligible reserves of fat and carbohydrate, and amino acids arising from protein turnover are used for energy-yielding metabolism rather than replacement protein synthesis, leading to **emaciation**, wasting, and, eventually, death (see Chapter 43).

In the fed state, after a meal, there is an ample supply of carbohydrate, and the metabolic fuel for most tissues is glucose. In the fasting state, glucose must be spared for use by the central nervous system (which is largely dependent on glucose) and the red blood cells (which are wholly reliant on glucose). Therefore, tissues that can use fuels other than glucose do so; muscle and liver oxidize fatty acids and the liver synthesizes ketone bodies from fatty acids to export to muscle and other tissues. As glycogen reserves become depleted, amino acids arising from protein turnover are used for **gluconeogenesis** (see Chapter 19).

The formation and utilization of reserves of triacylglycerol and glycogen, and the extent to which tissues take up and oxidize glucose, are largely controlled by the hormones **insulin** and **glucagon**. In **diabetes mellitus**, there is either impaired synthesis and secretion of insulin (type I diabetes, sometimes called juvenile onset, or insulin-dependent diabetes) or impaired sensitivity of tissues to insulin action (type II diabetes, sometimes called adult onset or noninsulin-dependent diabetes), leading to severe metabolic derangement. In cattle, the demands of heavy lactation can lead to ketosis, as can the demands of twin pregnancy in sheep.

PATHWAYS THAT PROCESS THE MAJOR PRODUCTS OF DIGESTION

The nature of the diet sets the basic pattern of metabolism. There is a need to process the products of digestion of dietary carbohydrate, lipid, and protein. These are mainly glucose, fatty acids and glycerol, and amino acids, respectively. In ruminants (and, to a lesser extent, other herbivores), dietary cellulose is fermented by symbiotic microorganisms to short-chain fatty acids (acetic, propionic, butyric), and metabolism in these animals is adapted to use these fatty acids as major substrates. All the products of digestion are metabolized to a **common product, acetyl-CoA**, which is then oxidized by the **citric acid cycle** (see Chapter 16) (Figure 14–1).

Carbohydrate Metabolism Is Centered on the Provision & Fate of Glucose

Glucose is the major fuel of most tissues (see Figure 14–2). It is metabolized to pyruvate by the pathway of **glycolysis** (see Chapter 17). Aerobic tissues metabolize pyruvate to **acetyl-CoA**,

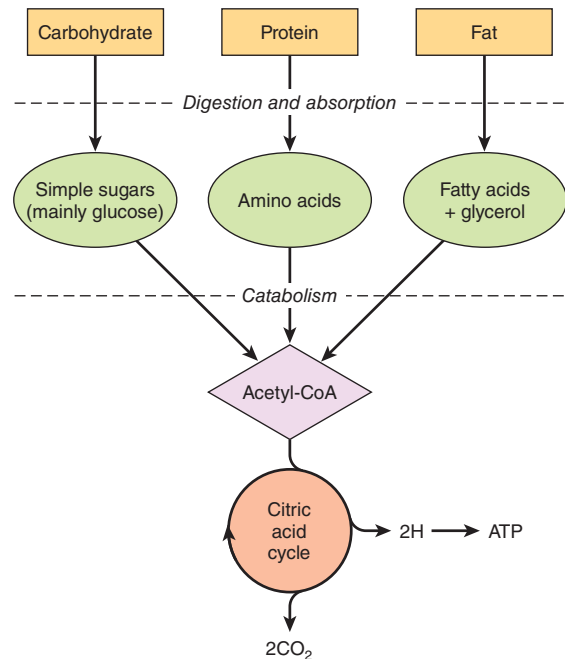

FIGURE 14–1 Outline of the pathways for the catabolism of carbohydrate, protein, and fat. All these pathways lead to the production of acetyl-CoA, which is oxidized in the citric acid cycle, ultimately yielding ATP by the process of oxidative phosphorylation.

which can enter the citric acid cycle for complete oxidation to CO_2 and H_2O , linked to the formation of ATP in the process of **oxidative phosphorylation** (see Figure 13–2). Glycolysis can also occur anaerobically (in the absence of oxygen) when the end product is lactate.

Glucose and its metabolites also take part in other processes, eg, the synthesis of the storage polymer **glycogen** in skeletal muscle and liver (see Chapter 18) and the **pentose phosphate pathway**, an alternative to part of the pathway of glycolysis (see Chapter 20). It is a source of reducing equivalents (NADPH) for fatty acid synthesis (see Chapter 23) and the source of **ribose** for nucleotide and nucleic acid synthesis (see Chapter 33). Triose phosphate intermediates in glycolysis give rise to the **glycerol moiety** of triacylglycerols. Pyruvate and intermediates of the citric acid cycle provide the carbon skeletons for the synthesis of nonessential or dispensable **amino acids** (see Chapter 27), and acetyl-CoA is the precursor of **fatty acids** (see Chapter 23) and **cholesterol** (see Chapter 26) and hence of all the steroid hormones synthesized in the body. **Gluconeogenesis** (see Chapter 19) is the process of synthesizing glucose from noncarbohydrate precursors such as, lactate, amino acids, and glycerol.

Lipid Metabolism Is Concerned Mainly With Fatty Acids & Cholesterol

The source of long-chain fatty acids is either dietary lipid or de novo synthesis from acetyl-CoA derived from carbohydrate or amino acids. Fatty acids may be oxidized to **acetyl-CoA** (β -oxidation) or esterified with glycerol, forming **triacylglycerol** as the body's main fuel reserve.

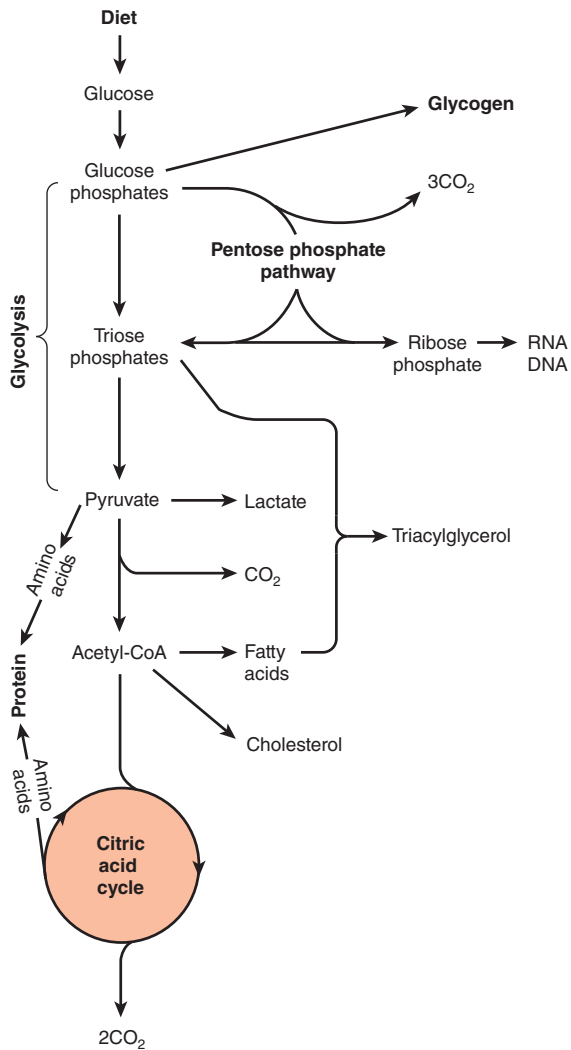

FIGURE 14-2 Overview of carbohydrate metabolism showing the major pathways and end products. Gluconeogenesis is not shown.

Acetyl-CoA formed by β -oxidation of fatty acids may undergo three fates (Figure 14-3):

1. As with acetyl-CoA arising from glycolysis, it is **oxidized** to $\text{CO}_2 + \text{H}_2\text{O}$ via the citric acid cycle.
2. It is the precursor for synthesis of **cholesterol** and other **steroids**.
3. In the liver, it is used to form the **ketone bodies**, acetoacetate and 3-hydroxybutyrate (see Chapter 22), which are important fuels in prolonged fasting and starvation.

Much of Amino Acid Metabolism Involves Transamination

The amino acids are required for protein synthesis (Figure 14-4). Some must be supplied in the diet (the **essential or indispensable amino acids**), since they cannot be synthesized in the body. The remainder are **nonessential or dispensable amino acids**, which are supplied in

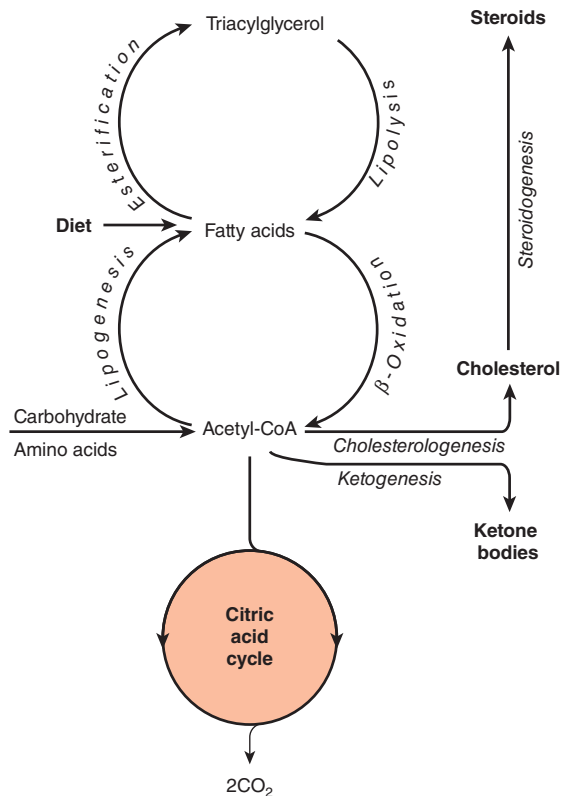

FIGURE 14-3 Overview of fatty acid metabolism showing the major pathways and end products. The ketone bodies are acetoacetate, 3-hydroxybutyrate, and acetone (which is formed nonenzymically by decarboxylation of acetoacetate).

the diet, but can also be formed from metabolic intermediates by **transamination** using the amino group from other amino acids (see Chapter 27). After **deamination**, amino nitrogen is excreted as **urea**, and the carbon skeletons that remain after transamination may (1) be oxidized to CO_2 via the citric acid cycle, (2) be used to synthesize glucose (gluconeogenesis), or (3) form ketone bodies or acetyl CoA, which may be oxidized or used for synthesis of fatty acids (see Chapter 28).

Several amino acids are also the precursors of other compounds, for example, purines, pyrimidines, hormones such as epinephrine and thyroxine, and neurotransmitters.

METABOLIC PATHWAYS MAY BE STUDIED AT DIFFERENT LEVELS OF ORGANIZATION

In addition to studies in the whole organism, the location and integration of metabolic pathways is revealed by studies at two levels of organization. At the **tissue and organ level** the nature of the substrates entering and metabolites leaving tissues and organs can be measured. At the **subcellular level**, each cell organelle (eg, the mitochondrion) or compartment (eg, the cytosol) has specific roles that form part of a subcellular pattern of metabolic pathways.

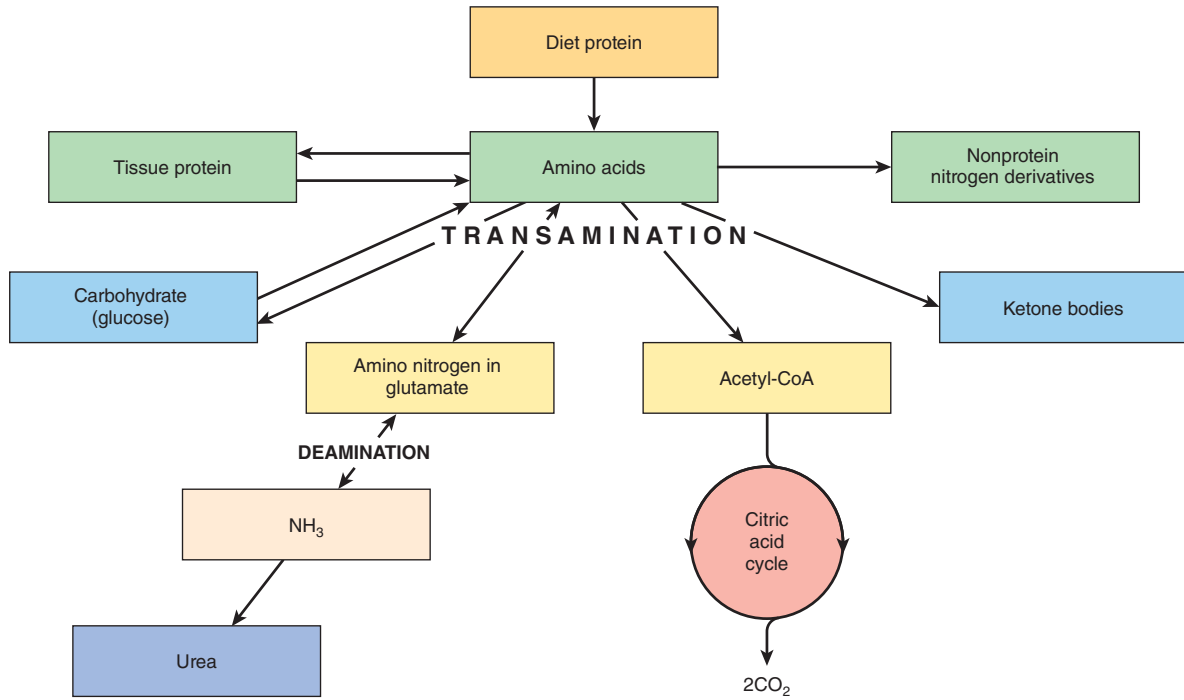

FIGURE 14-4 Overview of amino acid metabolism showing the major pathways and end products.

At the Tissue & Organ Level, the Blood Circulation Integrates Metabolism

Amino acids resulting from the digestion of dietary protein and glucose resulting from the digestion of carbohydrates are absorbed via the hepatic portal vein. The liver has the

role of regulating the blood concentration of these water-soluble metabolites (Figure 14-5). In the case of glucose, this is achieved by taking up glucose in excess of immediate requirements and using it to synthesize glycogen (glycogenesis, Chapter 18) or fatty acids (lipogenesis, Chapter 23).

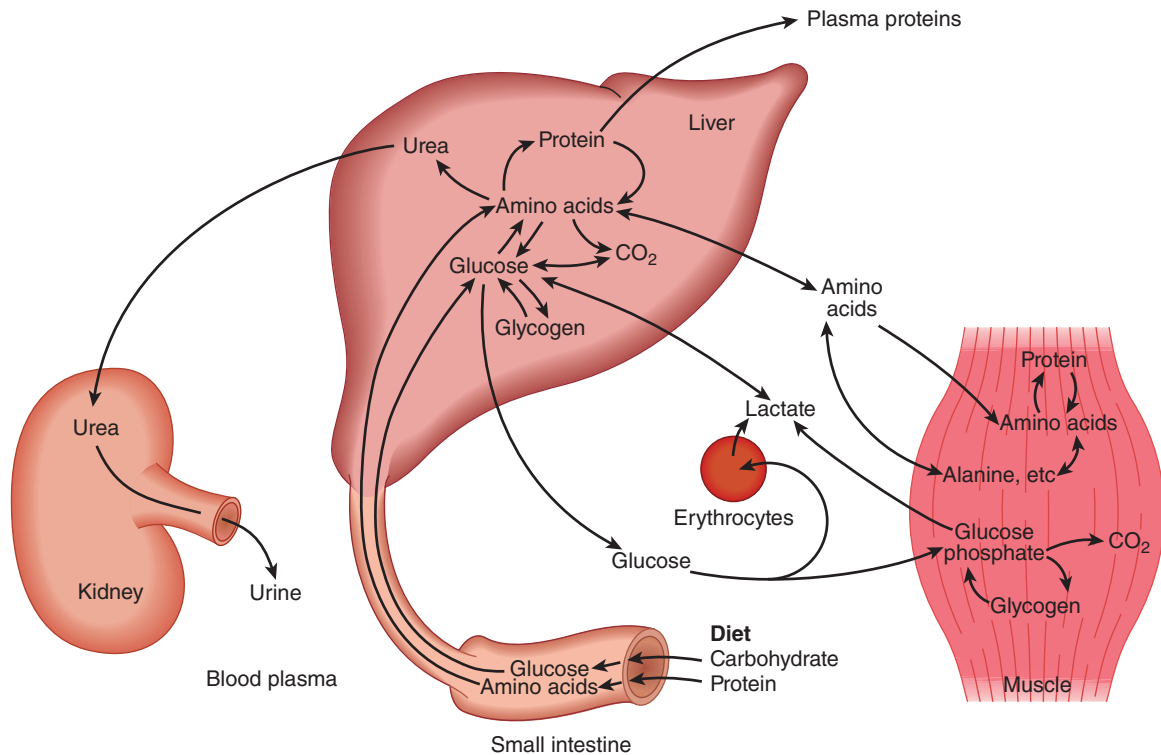

FIGURE 14-5 Transport and fate of major carbohydrate and amino acid substrates and metabolites. Note that there is little free glucose in muscle, since it is rapidly phosphorylated following uptake.

Between meals, the liver acts to maintain the blood glucose concentration by breaking down glycogen (**glycogenolysis**, see Chapter 18) and, together with the kidney, by converting noncarbohydrate metabolites such as lactate, glycerol, and amino acids to glucose (**gluconeogenesis**, see Chapter 19). The maintenance of an adequate blood concentration of glucose is essential for those tissues for which it is either the major fuel (the brain) or the only fuel (erythrocytes). The liver also **synthesizes the major plasma proteins** (eg, albumin) and **deaminates amino acids** that are in excess of requirements, synthesizing urea, which is transported to the kidney and excreted (see Chapter 28).

Skeletal muscle utilizes glucose as a fuel, both aerobically, forming CO_2 , and anaerobically, forming lactate. It stores glycogen as a fuel for use in muscle contraction and synthesizes muscle protein from plasma amino acids. Muscle accounts for approximately 50% of body mass and consequently represents a considerable store of protein that can be drawn upon to supply amino acids for gluconeogenesis in starvation (see Chapter 19).

Lipids in the diet (**Figure 14-6**) are mainly triacylglycerol, and are hydrolyzed to monoacylglycerols and fatty acids in the gut, then reesterified in the intestinal mucosa. Here they are packaged with protein and secreted into the lymphatic system and thence into the bloodstream as **chylomicrons**, the largest of the plasma **lipoproteins** (see Chapter 25). Chylomicrons also contain other

lipid-soluble nutrients, including vitamins A, D, E, and K (see Chapter 44). Unlike glucose and amino acids absorbed from the small intestine, chylomicron triacylglycerol is not taken up directly by the liver. It is first metabolized by tissues that have **lipoprotein lipase**, which hydrolyzes the triacylglycerol, releasing fatty acids that are incorporated into tissue lipids or oxidized as fuel. The chylomicron remnants are cleared by the liver. The other major source of long-chain fatty acids is synthesis (**lipogenesis**) from carbohydrate, in adipose tissue and the liver (see Chapter 23).

Adipose tissue triacylglycerol is the main fuel reserve of the body. It is hydrolyzed (**lipolysis**) and glycerol and non-esterified (free) fatty acids are released into the circulation. Glycerol is a substrate for gluconeogenesis (see Chapter 19). The fatty acids are transported bound to serum albumin; they are taken up by most tissues (but not brain or erythrocytes) and either esterified to triacylglycerols for storage or oxidized as a fuel. In the liver, newly synthesized triacylglycerol and triacylglycerol from chylomicron remnants (see Figure 25-3) is secreted into the circulation in **very low density lipoprotein (VLDL)**. This triacylglycerol undergoes a fate similar to that of chylomicrons. Partial oxidation of fatty acids in the liver leads to **ketone body** production (**ketogenesis**, Chapter 22). Ketone bodies are exported to extrahepatic tissues, where they provide a fuel in prolonged fasting and starvation.

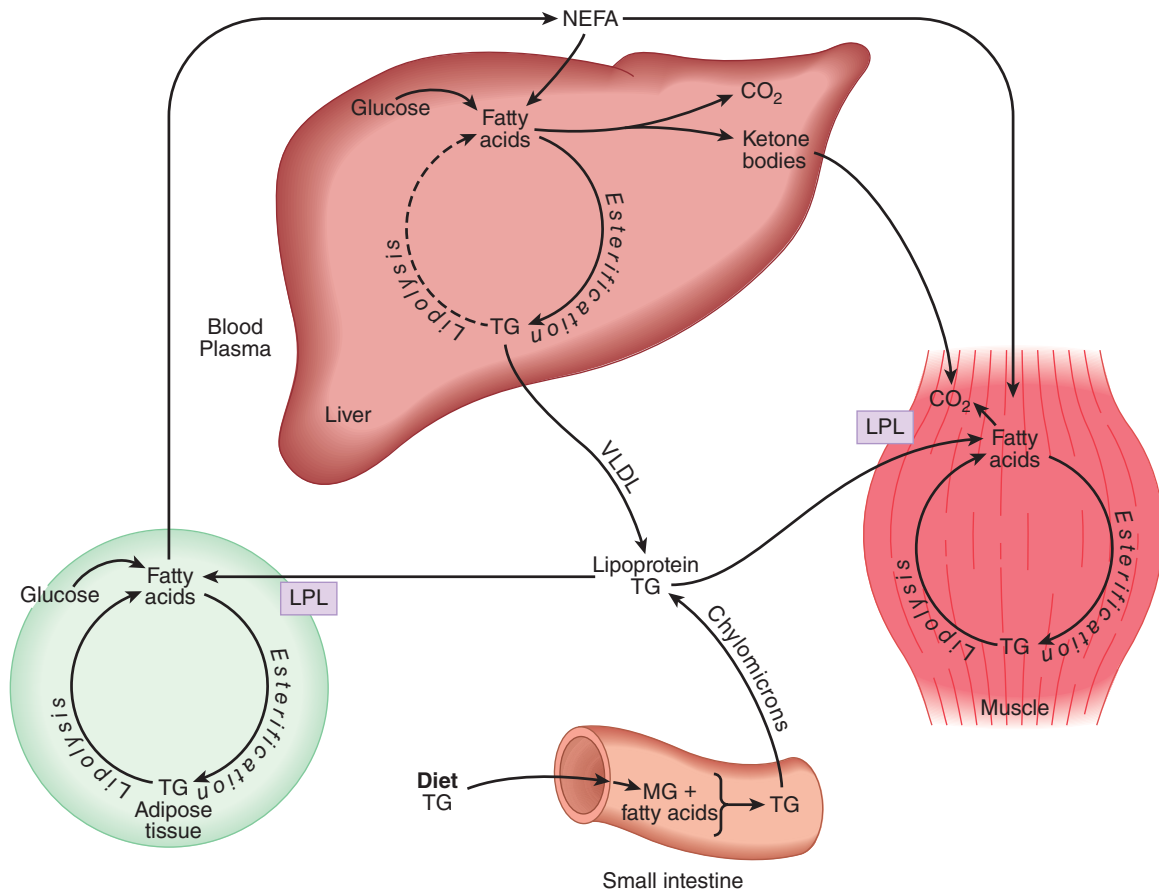

FIGURE 14-6 Transport and fate of major lipid substrates and metabolites. (LPL, lipoprotein lipase; MG, monoacylglycerol; NEFA, nonesterified fatty acids; TG, triacylglycerol; VLDL, very low density lipoprotein.)

At the Subcellular Level, Glycolysis Occurs in the Cytosol & the Citric Acid Cycle in the Mitochondria

Compartmentation of pathways in separate subcellular compartments or organelles permits integration and regulation of metabolism. Not all pathways are of equal importance in all cells. **Figure 14-7** depicts the subcellular compartmentation of metabolic pathways in a liver parenchymal cell.

The central role of the **mitochondrion** is immediately apparent, since it acts as the focus of carbohydrate, lipid, and

amino acid metabolism. It contains the enzymes of the citric acid cycle (see Chapter 16), β -oxidation of fatty acids and ketogenesis (see Chapter 22), as well as the respiratory chain and ATP synthase (see Chapter 13).

Glycolysis (see Chapter 17), the pentose phosphate pathway (see Chapter 20), and fatty acid synthesis (see Chapter 23) all occur in the cytosol. In gluconeogenesis (see Chapter 19), substrates such as lactate and pyruvate, which are formed in the cytosol, enter the mitochondrion to yield **oxaloacetate** as a precursor for the synthesis of glucose in the cytosol.

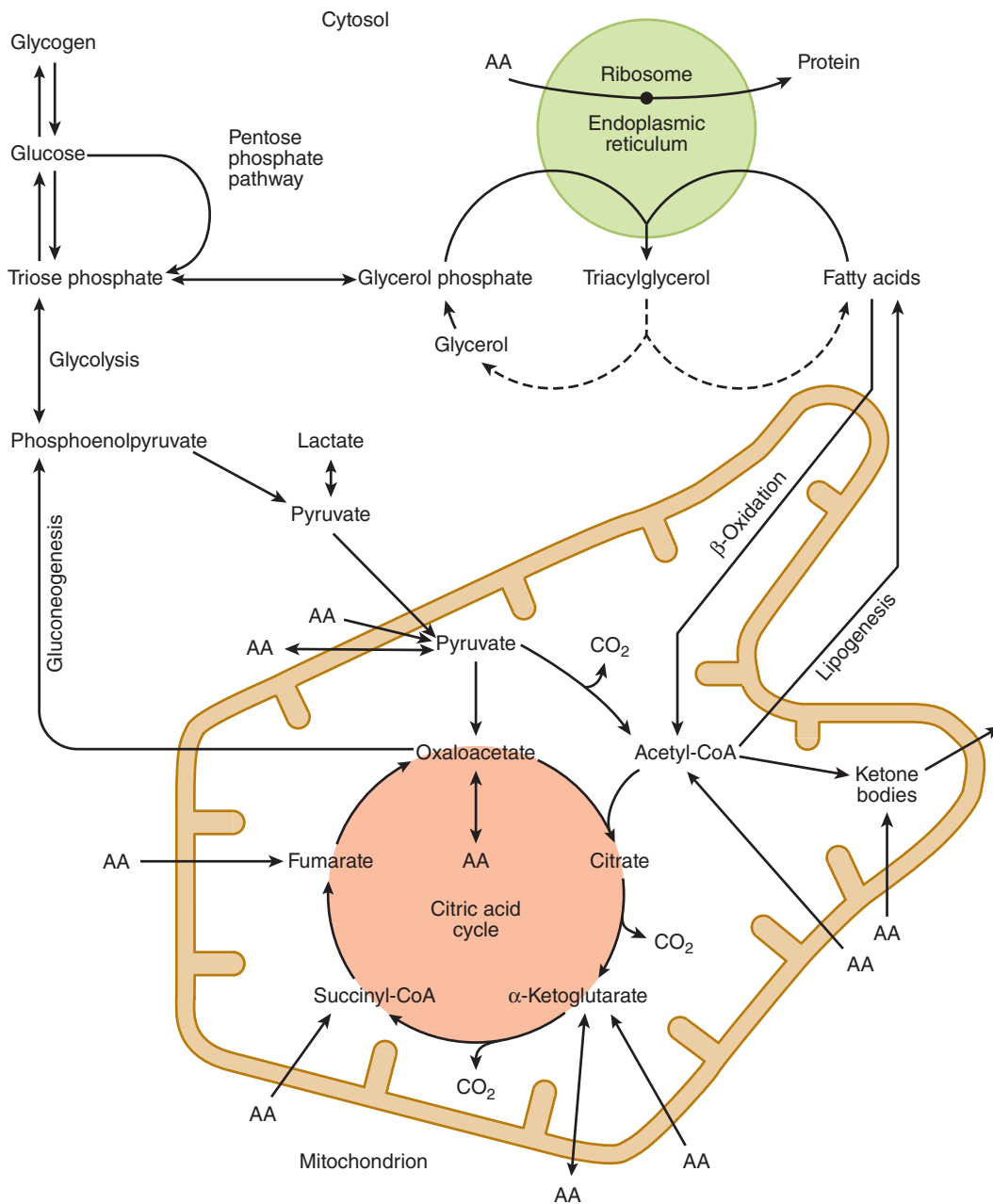

FIGURE 14-7 Intracellular location and overview of major metabolic pathways in a liver parenchymal cell. (AA →, metabolism of one or more essential amino acids; AA ↔, metabolism of one or more nonessential amino acids.)

The membranes of the **endoplasmic reticulum** contain the enzyme system for **triacylglycerol synthesis** (see Chapter 24), and the **ribosomes** are responsible for **protein synthesis** (see Chapter 37).

THE FLUX OF METABOLITES THROUGH METABOLIC PATHWAYS MUST BE REGULATED IN A CONCERTED MANNER

Regulation of the overall flux through a pathway is important to ensure an appropriate supply of the products of that pathway. It is achieved by control of one or more key reactions in the pathway, catalyzed by **regulatory enzymes**. The physicochemical factors that control the rate of an enzyme-catalyzed reaction, such as substrate concentration, are of primary importance in the control of the overall rate of a metabolic pathway (see Chapter 9).

Nonequilibrium Reactions Are Potential Control Points

In a reaction at equilibrium, the forward and reverse reactions occur at equal rates, and there is therefore no net flux in either direction.



In vivo, under “steady-state” conditions, there is a net flux from left to right because there is a continuous supply of substrate A and continuous removal of product D. In practice, there are normally one or more **nonequilibrium** reactions in a metabolic pathway, where the reactants are present in concentrations that are far from equilibrium. In attempting to reach equilibrium, large losses of free energy occur, making this type of reaction essentially irreversible. Such a pathway has both flow and direction. The enzymes catalyzing nonequilibrium reactions are usually present in low concentration and are subject to a variety of regulatory mechanisms. However, most reactions in metabolic pathways cannot be classified as equilibrium or nonequilibrium, but fall somewhere between the two extremes.

The Flux-Generating Reaction Is the First Reaction in a Pathway That Is Saturated With the Substrate

The flux-generating reaction can be identified as a nonequilibrium reaction in which the K_m of the enzyme is considerably lower than the normal concentration of substrate. The first reaction in glycolysis, catalyzed by hexokinase (see Figure 17–2), is such a flux-generating step because its K_m for glucose of 0.05 mmol/L is well below the normal blood glucose concentration of 3 to 5 mmol/L. Later reactions then control the rate of flux through the pathway.

ALLOSTERIC & HORMONAL MECHANISMS ARE IMPORTANT IN THE METABOLIC CONTROL OF ENZYME-CATALYZED REACTIONS

In the metabolic pathway shown in Figure 14–8,

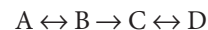

reactions $A \leftrightarrow B$ and $C \leftrightarrow D$ are equilibrium reactions and $B \rightarrow C$ is a nonequilibrium reaction. The flux through this pathway can be regulated by the availability of substrate A. This depends on its supply from the blood, which in turn depends on either food intake or key reactions that release substrates from tissue reserves into the bloodstream, for example, glycogen phosphorylase in liver (see Figure 18–1) and hormone-sensitive lipase in adipose tissue (see Figure 25–8). It also depends on the transport of substrate A into the cell. Muscle and adipose tissue only take up glucose from the bloodstream in response to the hormone insulin.

Flux is also determined by removal of the end product D and the availability of cosubstrates or cofactors represented by X and Y. Enzymes catalyzing nonequilibrium reactions are often allosteric proteins subject to the rapid actions of “feed-back” or “feed-forward” control by **allosteric modifiers**, in immediate response to the needs of the cell (see Chapter 9). Frequently, the end product of a biosynthetic pathway inhibits the enzyme catalyzing the first reaction in the pathway. Other control mechanisms depend on the action of **hormones** responding to the needs of the body as a whole; they may act rapidly by altering the activity of existing enzyme molecules, or slowly by altering the rate of enzyme synthesis (see Chapter 42).

MANY METABOLIC FUELS ARE INTERCONVERTIBLE

Carbohydrate in excess of requirements for immediate energy-yielding metabolism and formation of glycogen reserves in muscle and liver can readily be used for synthesis of fatty acids, and hence triacylglycerol in both adipose tissue and liver (whence it is exported in very low-density lipoprotein). The importance of lipogenesis in human beings is unclear; in Western countries dietary fat provides 35% to 45% of energy intake, while in less-developed countries, where carbohydrate may provide 60% to 75% of energy intake, the total intake of food is so low that there is little surplus for lipogenesis anyway. A high intake of fat inhibits lipogenesis in the adipose tissue and liver.

Fatty acids (and ketone bodies formed from them) cannot be used for the synthesis of glucose. The reaction of pyruvate dehydrogenase, forming acetyl-CoA, is irreversible, and for every two-carbon unit from acetyl-CoA that enters the citric acid cycle, there is a loss of two carbon atoms as carbon dioxide before oxaloacetate is reformed. This means that acetyl-CoA (and hence any substrates that yield acetyl-CoA) can never be used for gluconeogenesis.

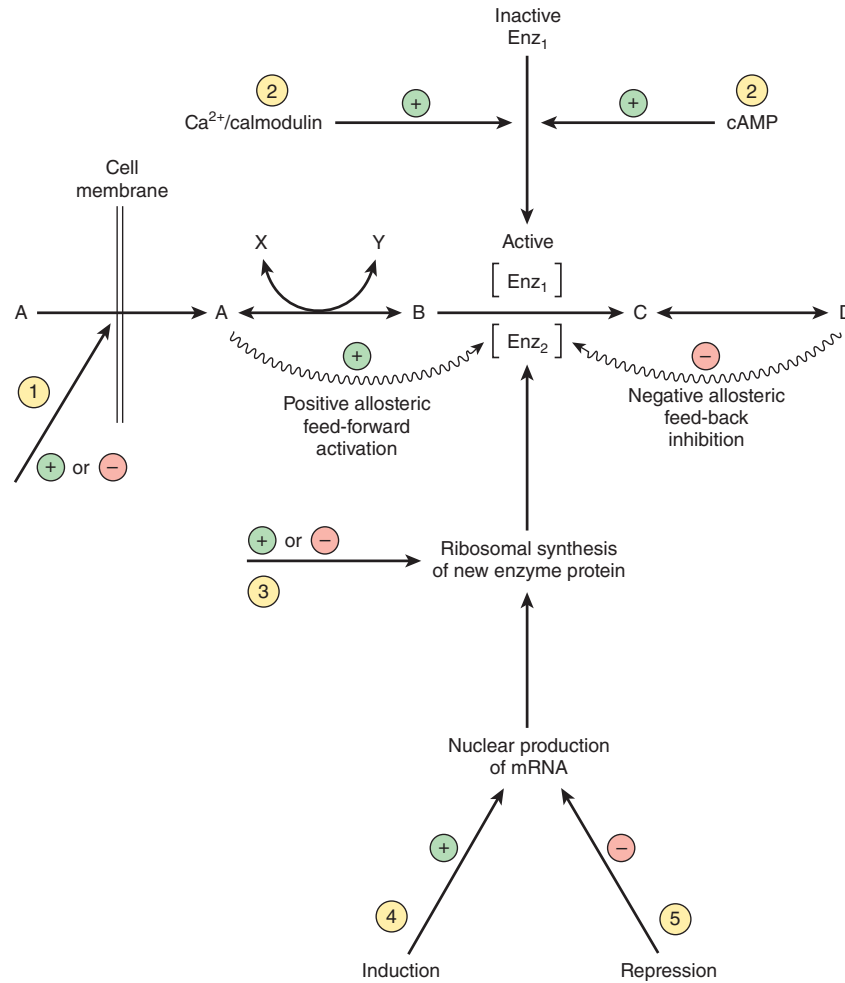

FIGURE 14-8 Mechanisms of control of an enzyme-catalyzed reaction.

Circled numbers indicate possible sites of action of hormones: ① alteration of membrane permeability; ② conversion of an inactive to an active enzyme, usually involving phosphorylation/dephosphorylation reactions; ③ alteration of the rate translation of mRNA at the ribosomal level; ④ induction of new mRNA formation; and ⑤ repression of mRNA formation. ① and ② are rapid, whereas ③, ④, and ⑤ are slower mechanisms of regulation.

The (relatively rare) fatty acids with an odd number of carbon atoms yield propionyl CoA as the product of the final cycle of β -oxidation, and this can be a substrate for gluconeogenesis, as can the glycerol released by lipolysis of adipose tissue triacylglycerol reserves.

Most of the amino acids in excess of requirements for protein synthesis (arising from the diet or from tissue protein turnover) yield pyruvate, or four- and five-carbon intermediates of the citric acid cycle (see Chapter 29). Pyruvate can be carboxylated to oxaloacetate, which is the primary substrate for gluconeogenesis, and the other intermediates of the cycle also result in a net increase in the formation of oxaloacetate, which is then available for gluconeogenesis. These amino acids are classified as **glucogenic**. Two amino acids (lysine and leucine) yield only acetyl-CoA on oxidation, and hence cannot be used for gluconeogenesis, and four others (phenylalanine, tyrosine,

tryptophan, and isoleucine) give rise to both acetyl-CoA and intermediates that can be used for gluconeogenesis. Those amino acids that give rise to acetyl-CoA are referred to as **ketogenic**, because in prolonged fasting and starvation much of the acetyl-CoA is used for synthesis of ketone bodies in the liver.

A SUPPLY OF METABOLIC FUELS IS PROVIDED IN BOTH THE FED & FASTING STATES

Glucose Is Always Required by the Central Nervous System and Erythrocytes

Erythrocytes lack mitochondria and hence are wholly reliant on (anaerobic) glycolysis and the pentose phosphate pathway

at all times. The brain can metabolize ketone bodies to meet about 20% of its energy requirements; the remainder must be supplied by glucose. The metabolic changes that occur in the fasting state and starvation serve to preserve glucose and the body's limited glycogen reserves for use by the brain and red blood cells, and to provide alternative metabolic fuels for other tissues. In pregnancy, the fetus requires a significant amount of glucose, as does the synthesis of lactose in lactation (Figure 14-9).

In the Fed State, Metabolic Fuel Reserves Are Laid Down

For several hours after a meal, while the products of digestion are being absorbed, there is an abundant supply of metabolic fuels. Under these conditions, glucose is the major fuel for oxidation in most tissues; this is observed as an increase in the respiratory quotient (the ratio of carbon dioxide produced/oxygen consumed) from about 0.8 in the fasting state to near 1 (Table 14-1).

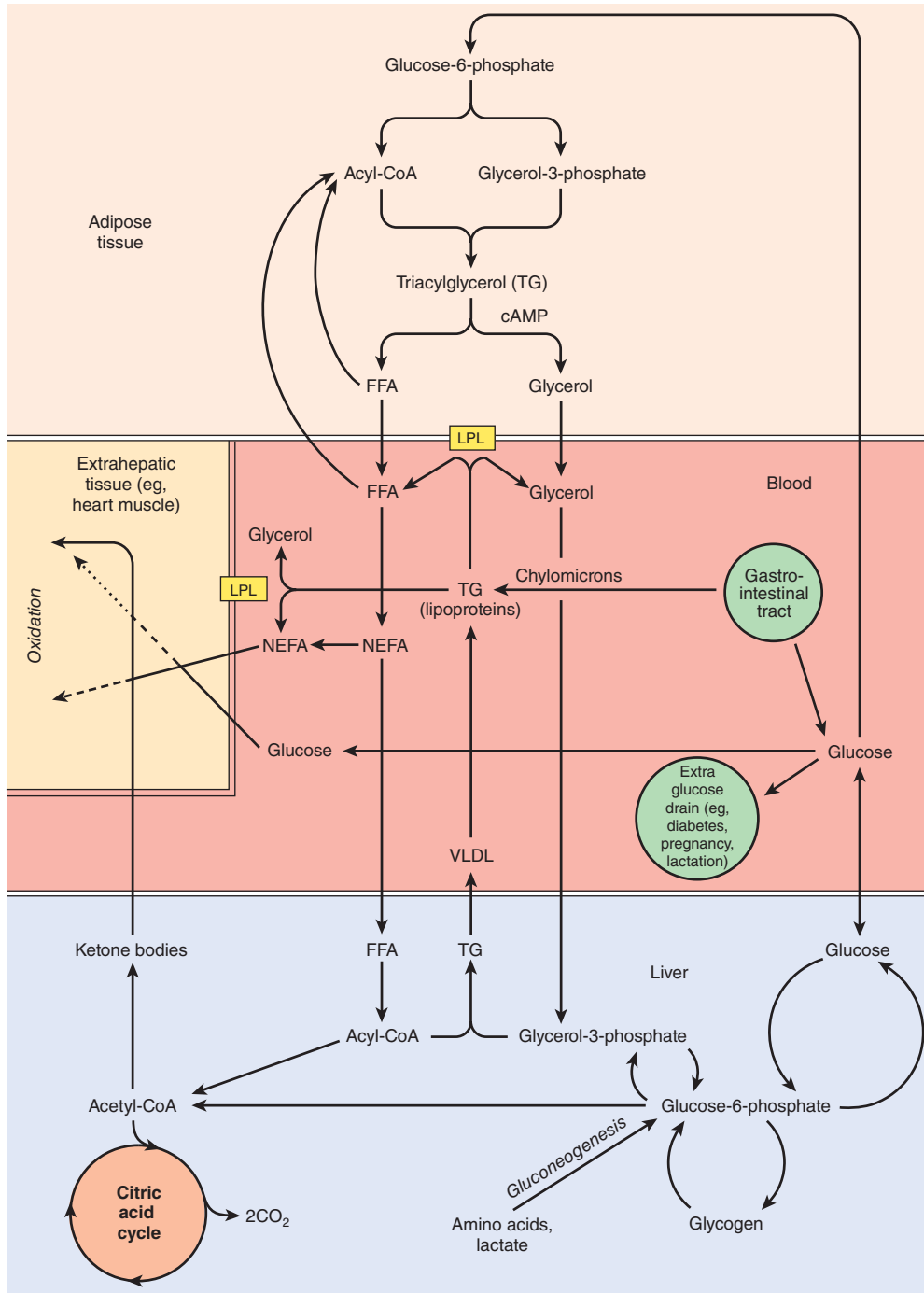

FIGURE 14-9 Metabolic interrelationships among adipose tissue, the liver, and extrahepatic tissues. In tissues such as heart, metabolic fuels are oxidized in the following order of preference: ketone bodies > fatty acids > glucose. (LPL, lipoprotein lipase; NEFA, nonesterified fatty acids; VLDL, very low density lipoproteins.)

TABLE 14–1 Energy Yields, Oxygen Consumption, and Carbon Dioxide Production in the Oxidation of Metabolic Fuels

	Energy Yield (kJ/g)	O ₂ Consumed (L/g)	CO ₂ Produced (L/g)	RQ (CO ₂ Produced/ O ₂ Consumed)	Energy (kJ)/L O ₂
Carbohydrate	16	0.829	0.829	1.00	~20
Protein	17	0.966	0.782	0.81	~20
Fat	37	2.016	1.427	0.71	~20
Alcohol	29	1.429	0.966	0.66	~20

Glucose uptake into muscle and adipose tissue is controlled by **insulin**, which is secreted by the β -islet cells of the pancreas in response to an increased concentration of glucose in the portal blood. In the fasting state, the glucose transporter of muscle and adipose tissue (GLUT-4) is in intracellular vesicles. An early response to insulin is the migration of these vesicles to the cell surface, where they fuse with the plasma membrane, exposing active glucose transporters. These insulin-sensitive tissues only take up glucose from the bloodstream to any significant extent in the presence of the hormone. As insulin secretion falls in the fasting state, so the receptors are internalized again, reducing glucose uptake. However, in skeletal muscle, the increase in cytoplasmic calcium ion concentration in response to nerve stimulation stimulates the migration of the vesicles to the cell surface and exposure of active glucose transporters whether or not there is significant insulin stimulation.

The uptake of glucose into the liver is independent of insulin, but liver has an isoenzyme of hexokinase (glucokinase) with a high K_m , so that as the concentration of glucose entering the liver increases, so does the rate of synthesis of glucose-6-phosphate. This is in excess of the liver's requirement for energy-yielding metabolism, and is used mainly for synthesis of **glycogen**. In both liver and skeletal muscle, insulin acts to stimulate glycogen synthetase and inhibit glycogen phosphorylase. Some of the additional glucose entering the liver may also be used for lipogenesis and hence triacylglycerol synthesis. In adipose tissue, insulin stimulates glucose uptake, its conversion to fatty acids, and their esterification to triacylglycerol. It inhibits intracellular lipolysis and the release of nonesterified fatty acids.

The products of lipid digestion enter the circulation as **chylomicrons**, the largest of the plasma lipoproteins, which are especially rich in triacylglycerol (see Chapter 25). In adipose tissue and skeletal muscle, extracellular lipoprotein lipase is synthesized and activated in response to insulin; the resultant nonesterified fatty acids are largely taken up by the tissue and

used for synthesis of triacylglycerol, while the glycerol remains in the bloodstream and is taken up by the liver and used for either gluconeogenesis and glycogen synthesis or lipogenesis. Fatty acids remaining in the bloodstream are taken up by the liver and reesterified. The lipid-depleted chylomicron remnants are cleared by the liver, and the remaining triacylglycerol is exported, together with that synthesized in the liver, in **very low density lipoprotein**.

Under normal conditions, the rate of tissue protein catabolism is more or less constant throughout the day; it is only in **cachexia** associated with advanced cancer and other diseases that there is an increased rate of protein catabolism. There is net protein catabolism in the fasting state, when the rate of protein synthesis falls, and net protein synthesis in the fed state, when the rate of synthesis increases by 20% to 25%. The increased rate of protein synthesis in response to increased availability of amino acids and metabolic fuel is again a response to insulin action. Protein synthesis is an energy expensive process; it may account for up to 20% of resting energy expenditure after a meal, but only 9% in the fasting state.

Metabolic Fuel Reserves Are Mobilized in the Fasting State

There is a small fall in plasma glucose in the fasting state, and then little change as fasting is prolonged into starvation. Plasma nonesterified fatty acids increase in fasting, but then rise little more in starvation; as fasting is prolonged, the plasma concentration of ketone bodies (acetoacetate and 3-hydroxybutyrate) increases markedly (**Table 14–2, Figure 14–10**).

In the fasting state, as the concentration of glucose in the portal blood coming from the small intestine falls, insulin secretion decreases, and skeletal muscle and adipose tissue take up less glucose. The increase in secretion of **glucagon** by α cells of the pancreas inhibits glycogen synthetase, and activates glycogen phosphorylase in the liver. The resulting glucose-6-phosphate is

TABLE 14–2 Plasma Concentrations of Metabolic Fuels (mmol/L) in the Fed and Fasting States

	Fed	40 h Fasting	7 Days Starvation
Glucose	5.5	3.6	3.5
Nonesterified fatty acids	0.30	1.15	1.19
Ketone bodies	Negligible	2.9	4.5

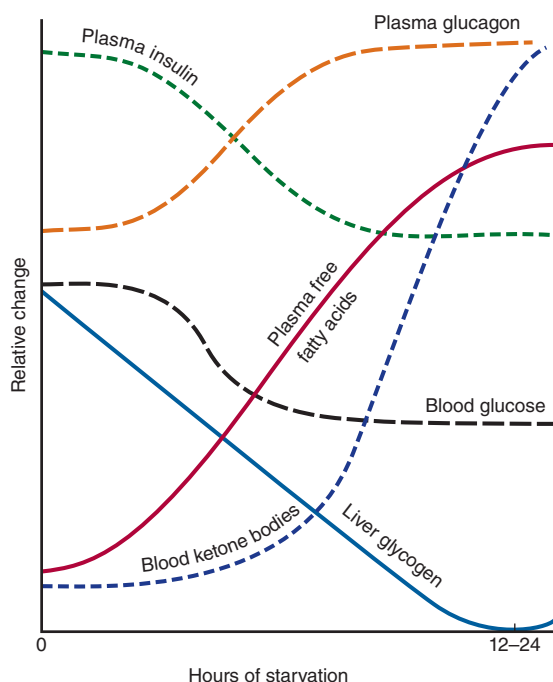

FIGURE 14-10 Relative changes in plasma hormones and metabolic fuels during the onset of starvation.

hydrolyzed by glucose 6-phosphatase, and glucose is released into the bloodstream for use by the brain and erythrocytes.

Muscle glycogen cannot contribute directly to plasma glucose, since muscle lacks glucose-6-phosphatase, and the primary use of muscle glycogen is to provide a source of glucose-6-phosphate for energy-yielding metabolism in the muscle itself. However, acetyl-CoA formed by oxidation of fatty acids in muscle inhibits pyruvate dehydrogenase, leading to an accumulation of pyruvate. Most of this is transaminated to alanine, at the expense of amino acids arising from breakdown of muscle protein. The alanine, and much of the keto acids resulting from this transamination are exported from muscle, and taken up by the liver, where the alanine is transaminated to yield pyruvate. The resultant amino acids are largely exported back to muscle, to provide amino groups for formation of more alanine, while the pyruvate provides a substrate for gluconeogenesis in the liver.

In adipose tissue, the decrease in insulin and increase in glucagon results in inhibition of lipogenesis, inactivation and internalization of lipoprotein lipase, and activation of intracellular hormone-sensitive lipase (see Chapter 25). This leads to release from adipose tissue of increased amounts of glycerol (which is a substrate for gluconeogenesis in the liver) and nonesterified fatty acids, which are used by liver, heart, and skeletal muscle as their preferred metabolic fuel, so sparing glucose.

Although muscle preferentially takes up and metabolizes nonesterified fatty acids in the fasting state, it cannot meet all of its energy requirements by β -oxidation. By contrast, the liver has a greater capacity for β -oxidation than is required to meet its own energy needs, and as fasting becomes more prolonged, it forms more acetyl-CoA than can be oxidized. This acetyl-CoA is used to synthesize the **ketone bodies**

(see Chapter 22), which are major metabolic fuels for skeletal and heart muscle and can meet up to 20% of the brain's energy needs. In prolonged starvation, glucose may represent less than 10% of whole body energy-yielding metabolism.

Were there no other source of glucose, liver and muscle glycogen would be exhausted after about 18 hours fasting. As fasting becomes more prolonged, so an increasing amount of the amino acids released as a result of protein catabolism is utilized in the liver and kidneys for gluconeogenesis (Table 14-3).

CLINICAL ASPECTS

In prolonged starvation, as adipose tissue reserves are depleted, there is a very considerable increase in the net rate of protein catabolism to provide amino acids, not only as substrates for gluconeogenesis, but also as the main metabolic fuel of all tissues. Death results when essential tissue proteins are catabolized and not replaced. In patients with **cachexia** as a result of release of **cytokines** in response to tumors and disease, there is an increase in the rate of tissue protein catabolism, as well as a considerably increased metabolic rate, so they are in a state of advanced starvation. Again, death results when essential tissue proteins are catabolized and not replaced.

The high demand for glucose by the fetus, and for lactose synthesis in lactation, can lead to ketosis. This may be seen as mild ketosis with hypoglycemia in human beings; in lactating cattle and in ewes carrying a twin pregnancy, there may be very pronounced ketoacidosis and profound hypoglycemia.

In poorly controlled type 1 **diabetes mellitus**, patients may become hyperglycemic, both as a result of lack of insulin to stimulate uptake and utilization of glucose, and because in the absence of insulin to antagonize the actions of glucagon, there is increased gluconeogenesis from amino acids in the liver. At the same time, the lack of insulin to antagonize the actions of glucagon results in increased lipolysis in adipose tissue, and the resultant nonesterified fatty acids are substrates for ketogenesis in the liver.

Utilization of the ketone bodies in muscle (and other tissues) may be impaired because of the lack of oxaloacetate (all tissues have a requirement for some glucose metabolism to maintain an adequate amount of oxaloacetate for citric acid cycle activity). In uncontrolled diabetes, the ketosis may be severe enough to result in pronounced acidosis (**ketoacidosis**); acetoacetate and 3-hydroxybutyrate are relatively strong acids. Coma results from both the acidosis and also the considerably increased osmolality of extracellular fluid (mainly as a result of the hyperglycemia, and diuresis resulting from the excretion of glucose and ketone bodies in the urine).

SUMMARY

- The products of digestion provide the tissues with the building blocks for the biosynthesis of complex molecules and also with the fuel for metabolic processes.
- Nearly all products of digestion of carbohydrate, fat, and protein are metabolized to a common metabolite, acetyl-CoA, before oxidation to CO_2 in the citric acid cycle.

TABLE 14-3 Summary of the Major Metabolic Features of the Principal Organs

Organ	Major Pathways	Main Substrates	Major Products Exported	Specialist Enzymes
Liver	Glycolysis, gluconeogenesis, lipogenesis, β -oxidation, citric acid cycle, ketogenesis, lipoprotein metabolism, drug metabolism, synthesis of bile salts, urea, uric acid, cholesterol, plasma proteins	Nonesterified fatty acids, glucose (in fed state), lactate, glycerol, fructose, amino acids, alcohol	Glucose, triacylglycerol in VLDL, ^a ketone bodies, urea, uric acid, bile salts, cholesterol, plasma proteins	Glucokinase, glucose-6-phosphatase, glycerol kinase, phosphoenolpyruvate carboxykinase, fructokinase, arginase, HMG CoA synthase, HMG CoA lyase, alcohol dehydrogenase
Brain	Glycolysis, citric acid cycle, amino acid metabolism, neurotransmitter synthesis	Glucose, amino acids, ketone bodies in prolonged starvation	Lactate, end products of neurotransmitter metabolism	Those for synthesis and catabolism of neurotransmitters
Heart	β -Oxidation and citric acid cycle	Ketone bodies, nonesterified fatty acids, lactate, chylomicron and VLDL triacylglycerol, some glucose	—	Lipoprotein lipase, very active electron transport chain
Adipose tissue	Lipogenesis, esterification of fatty acids, lipolysis (in fasting)	Glucose, chylomicron and VLDL triacylglycerol	Nonesterified fatty acids, glycerol	Lipoprotein lipase, hormone-sensitive lipase, enzymes of the pentose phosphate pathway
Fast twitch muscle	Glycolysis	Glucose, glycogen	Lactate, (alanine and ketoacids in fasting)	—
Slow twitch muscle	β -Oxidation and citric acid cycle	Ketone bodies, chylomicron and VLDL triacylglycerol	—	Lipoprotein lipase, very active electron transport chain
Kidney	Gluconeogenesis	Nonesterified fatty acids, lactate, glycerol, glucose	Glucose	Glycerol kinase, phosphoenolpyruvate carboxykinase
Erythrocytes	Anerobic glycolysis, pentose phosphate pathway	Glucose	Lactate	Hemoglobin, enzymes of pentose phosphate pathway

^aVLDL, very low density lipoprotein.

- Acetyl-CoA is also the precursor for synthesis of long-chain fatty acids and steroids (including cholesterol) and ketone bodies.
 - Glucose provides carbon skeletons for the glycerol of triacylglycerols and nonessential amino acids.
 - Water-soluble products of digestion are transported directly to the liver via the hepatic portal vein. The liver regulates the concentrations of glucose and amino acids available to other tissues. Lipids and lipid-soluble products of digestion enter the bloodstream from the lymphatic system, and the liver clears the remnants after extra-hepatic tissues have taken up fatty acids.
 - Pathways are compartmentalized within the cell. Glycolysis, glycogenesis, glycogenolysis, the pentose phosphate pathway, and lipogenesis occur in the cytosol. The mitochondria contain the enzymes of the citric acid cycle and for β -oxidation of fatty acids, as well as the respiratory chain and ATP synthase.
- The membranes of the endoplasmic reticulum contain the enzymes for a number of other processes, including triacylglycerol synthesis and drug metabolism.
- Metabolic pathways are regulated by rapid mechanisms affecting the activity of existing enzymes, that is, allosteric and covalent modification (often in response to hormone action) and slow mechanisms that affect the synthesis of enzymes.
 - Dietary carbohydrate and amino acids in excess of requirements can be used for fatty acid and hence triacylglycerol synthesis.
 - In fasting and starvation, glucose must be provided for the brain and red blood cells; in the early fasting state, this is supplied from glycogen reserves. In order to spare glucose, muscle and other tissues do not take up glucose when insulin secretion is low; they utilize fatty acids (and later ketone bodies) as their preferred fuel.

- Adipose tissue releases nonesterified fatty acids in the fasting state. In prolonged fasting and starvation these are used by the liver for synthesis of ketone bodies, which are exported to provide the major fuel for muscle.
- Most amino acids, arising from the diet or from tissue protein turnover, can be used for gluconeogenesis, as can the glycerol from triacylglycerol.
- Neither fatty acids, arising from the diet or from lipolysis of adipose tissue triacylglycerol, nor ketone bodies, formed from fatty acids in the fasting state, can provide substrates for gluconeogenesis.

REFERENCES

- Bender DA: *Introduction to Nutrition and Metabolism*, 5th ed. CRC Press, 2014.
- Brosnan JT: Comments on the metabolic needs for glucose and the role of gluconeogenesis. *Eur J Clin Nutr* 1999;53:S107–S111.
- Frayn KN: Integration of substrate flow in vivo: some insights into metabolic control. *Clin Nutr* 1997;16:277–282.
- Frayn KN: *Metabolic Regulation: A Human Perspective*, 3rd ed. Wiley-Blackwell, 2010.
- Zierler K: Whole body metabolism of glucose. *Am J Physiol* 1999;276:E409–E426.

Carbohydrates of Physiological Significance

David A. Bender, PhD & Peter A. Mayes, PhD, DSc

OBJECTIVES

After studying this chapter, you should be able to:

- Explain what is meant by the glycome, glycobiology, and the science of glycomics.
- Explain what is meant by the terms monosaccharide, disaccharide, oligosaccharide, and polysaccharide.
- Explain the different ways in which the structures of glucose and other monosaccharides can be represented, and describe the various types of isomerism of sugars and the pyranose and furanose ring structures.
- Describe the formation of glycosides and the structures of the important disaccharides and polysaccharides.
- Explain what is meant by the glycemic index of a carbohydrate.
- Describe the roles of carbohydrates in cell membranes and lipoproteins.

BIOMEDICAL IMPORTANCE

Carbohydrates are widely distributed in plants and animals; they have important structural and metabolic roles. In plants, glucose is synthesized from carbon dioxide and water by photosynthesis and stored as starch or used to synthesize the cellulose of the plant cell walls. Animals can synthesize carbohydrates from amino acids, but most are derived ultimately from plants. **Glucose** is the most important carbohydrate; most dietary carbohydrate is absorbed into the bloodstream as glucose formed by hydrolysis of dietary starch and disaccharides, and other sugars are converted to glucose in the liver. Glucose is the major metabolic fuel of mammals (except ruminants) and a universal fuel of the fetus. It is the precursor for synthesis of all the other carbohydrates in the body, including **glycogen** for storage; **ribose** and **deoxyribose** in nucleic acids; **galactose** for synthesis of lactose in milk, in glycolipids, and in combination with protein in glycoproteins (see Chapter 46) and proteoglycans. Diseases associated with carbohydrate metabolism include **diabetes mellitus**, **galactosemia**, **glycogen storage diseases**, and **lactose intolerance**.

Glycobiology is the study of the roles of sugars in health and disease. The **glycome** is the entire complement of sugars of an organism, whether free or present in more complex molecules. **Glycomics**, an analogous term to genomics and proteomics, is

the comprehensive study of glycomes, including genetic, physiological, pathological, and other aspects.

A very large number of glycoside links can be formed between sugars. For example, three different hexoses may be linked to each other to form over 1000 different trisaccharides. The conformations of the sugars in oligosaccharide chains vary depending on their linkages and proximity to other molecules with which the oligosaccharides may interact. Oligosaccharide chains encode **biological information** and that this depends upon their constituent sugars, their sequences, and their linkages.

CARBOHYDRATES ARE ALDEHYDE OR KETONE DERIVATIVES OF POLYHYDRIC ALCOHOLS

Carbohydrates are classified as follows:

1. **Monosaccharides** are those sugars that cannot be hydrolyzed into simpler carbohydrates. They may be classified as **trioses**, **tetroses**, **pentoses**, **hexoses**, or **heptoses**, depending upon the number of carbon atoms (3-7), and as **aldoses** or **ketoses**, depending on whether they have

TABLE 15-1 Classification of Important Sugars

	Aldoses	Ketoses
Trioses (C ₃ H ₆ O ₃)	Glycerose (glyceraldehyde)	Dihydroxyacetone
Tetroses (C ₄ H ₈ O ₄)	Erythrose	Erythrulose
Pentoses (C ₅ H ₁₀ O ₅)	Ribose	Ribulose
Hexoses (C ₆ H ₁₂ O ₆)	Glucose	Fructose
Heptoses (C ₇ H ₁₄ O ₇)	—	Sedoheptulose

an aldehyde or ketone group. Examples are listed in **Table 15-1**. In addition to aldehydes and ketones, the polyhydric alcohols (sugar alcohols or **polyols**), in which the aldehyde or ketone group has been reduced to an alcohol group, also occur naturally in foods. They are synthesized by reduction of monosaccharides for use in the manufacture of foods for weight reduction and for diabetics. They are poorly absorbed, and have about half the energy yield of sugars.

- Disaccharides** are condensation products of two monosaccharide units, for example, lactose, maltose, isomaltose, sucrose, and trehalose.
- Oligosaccharides** are condensation products of three to ten monosaccharides. Most are not digested by human enzymes.
- Polysaccharides** are condensation products of more than ten monosaccharide units; examples are the starches and dextrans, which may be linear or branched polymers. Polysaccharides are sometimes classified as hexosans or pentosans, depending on the constituent monosaccharides (hexoses and pentoses, respectively). In addition to starches and dextrans (which are hexosans), foods contain a wide variety of other polysaccharides that are collectively known as nonstarch polysaccharides; they are not digested by human enzymes, and are the major component of dietary fiber. Examples are cellulose from plant cell walls (a glucose polymer; see Figure 15-13) and inulin, the storage carbohydrate in some plants (a fructose polymer; see Figure 15-13).

BIOMEDICALLY, GLUCOSE IS THE MOST IMPORTANT MONOSACCHARIDE

The Structure of Glucose Can Be Represented in Three Ways

The straight-chain structural formula (aldohexose; **Figure 15-1A**) can account for some of the properties of glucose, but a cyclic structure (a **hemiacetal** formed by reaction between the aldehyde group and a hydroxyl group) is thermodynamically favored and accounts for other properties. The cyclic structure

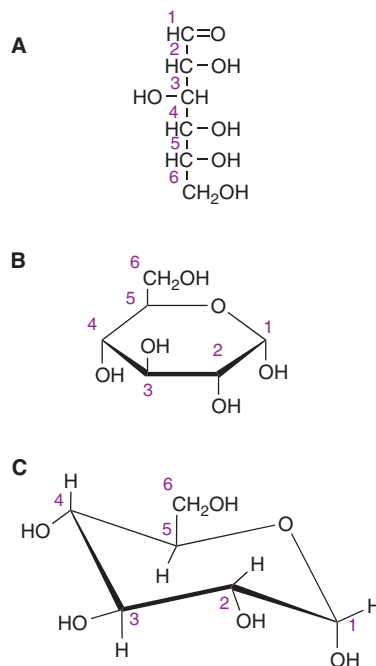

FIGURE 15-1 **D-Glucose.**(A) Straight-chain form. (B) α -D-glucose; Haworth projection. (C) α -D-glucose; chair form.

is normally drawn as shown in **Figure 15-1B**, the Haworth projection, in which the molecule is viewed from the side and above the plane of the ring; the bonds nearest to the viewer are bold and thickened, and the hydroxyl groups are above or below the plane of the ring. The hydrogen atoms attached to each carbon are not shown in this figure. The ring is actually in the form of a chair (**Figure 15-1C**).

Sugars Exhibit Various Forms of Isomerism

Glucose, with four asymmetric carbon atoms, can form 16 isomers. The more important types of isomerism found with glucose are as follows.

- D and L isomerism:** The designation of a sugar isomer as the D form or its mirror image as the L form is determined by its spatial relationship to the parent compound of the carbohydrates, the three-carbon sugar glycerose (glyceraldehyde). The L and D forms of this sugar, and of glucose, are shown in **Figure 15-2**. The orientation of the —H and —OH groups around the carbon atom adjacent to the terminal alcohol carbon (carbon 5 in glucose) determines whether the sugar belongs to the D or L series. When the —OH group on this carbon is on the right (as seen in Figure 15-2), the sugar is the D isomer; when it is on the left, it is the L isomer. Most of the naturally occurring monosaccharides are D sugars, and the enzymes responsible for their metabolism are specific for this configuration.
- The presence of asymmetric carbon atoms also confers **optical activity** on the compound. When a beam of plane-polarized light is passed through a solution of an **optical isomer**, it rotates either to the right, dextrorotatory (+), or to the left, levorotatory (–). The direction of rotation

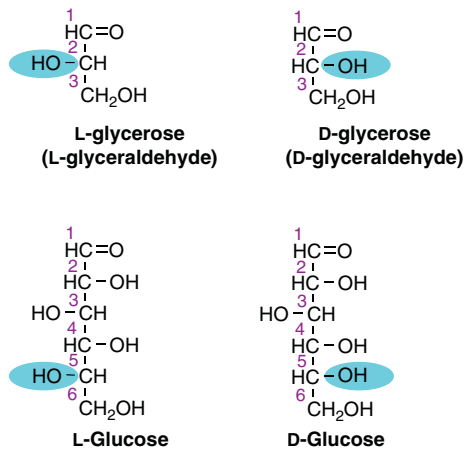

FIGURE 15-2 D- and L-isomerism of glycerose and glucose.

of polarized light is independent of the stereochemistry of the sugar, so it may be designated D(-), D(+), L(-), or L(+). For example, the naturally occurring form of fructose is the D(-) isomer. Confusingly, dextrorotatory (+) was at one time called d-, and levorotatory (-) l-. This nomenclature is obsolete, but may sometimes be found; it is unrelated to D- and L-isomerism. In solution, glucose is dextrorotatory, and glucose solutions are sometimes known as **dextrose**.

- Pyranose and furanose ring structures:** The ring structures of monosaccharides are similar to the ring structures of either pyran (a six-membered ring) or furan (a five-membered ring) (Figures 15-3 and 15-4). For glucose in solution, more than 99% is in the pyranose form.
- Alpha and beta anomers:** The ring structure of an aldose is a hemiacetal, since it is formed by reaction between an aldehyde and an alcohol group. Similarly, the ring structure of a ketose is a hemiketal. Crystalline glucose is α -D-glucopyranose. The cyclic structure is retained in the solution, but isomerism occurs about position 1, the carbonyl or **anomeric carbon atom**, to give a mixture of α -glucopyranose (38%) and β -glucopyranose (62%). Less than 0.3% is represented by α and β anomers of glucofuranose.

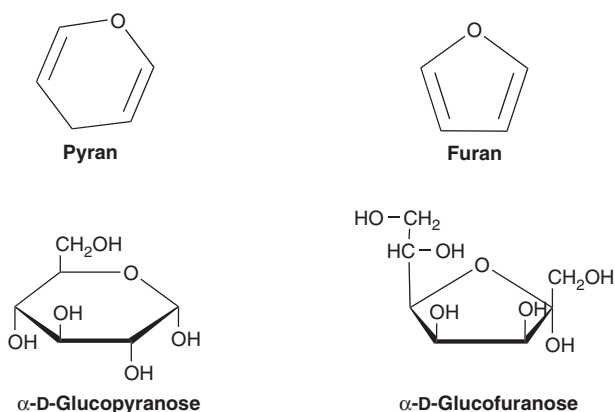

FIGURE 15-3 Pyranose and furanose forms of glucose.

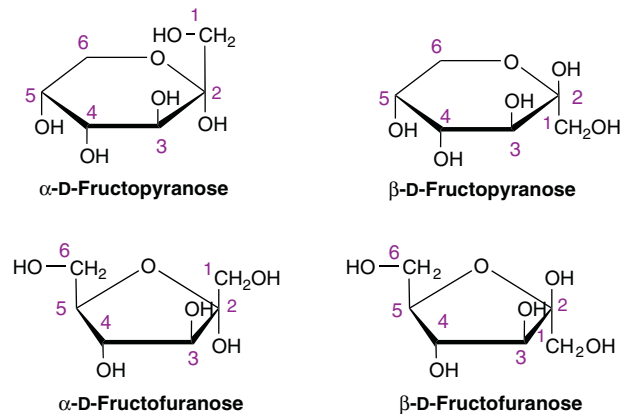

FIGURE 15-4 Pyranose and furanose forms of fructose.

- Epimers:** Isomers differing as a result of variations in configuration of the —OH and —H on carbon atoms 2, 3, and 4 of glucose are known as epimers. Biologically, the most important epimers of glucose are mannose (epimerized at carbon 2) and galactose (epimerized at carbon 4) (Figure 15-5).
- Aldose-ketose isomerism:** Fructose has the same molecular formula as glucose but differs in that there is a potential keto group in position 2, the anomeric carbon of fructose, whereas in glucose there is a potential aldehyde group in position 1, the anomeric carbon. Examples of aldose and ketose sugars are shown in Figures 15-6 and 15-7. Chemically, aldoses are reducing compounds, and are sometimes known as reducing sugars. This provides the basis for a simple chemical test for glucose in urine in poorly controlled diabetes mellitus, by reduction of an alkaline copper solution (Chapter 48).

Many Monosaccharides Are Physiologically Important

Derivatives of trioses, tetroses, and pentoses and of the seven-carbon sugar sedoheptulose, are formed as metabolic intermediates in glycolysis (see Chapter 17) and the pentose phosphate pathway (see Chapter 20). Pentoses are important in nucleotides, nucleic acids, and several coenzymes (Table 15-2). Glucose, galactose, fructose, and mannose are physiologically the most important hexoses (Table 15-3). The biochemically important ketoses are shown in Figure 15-6, and aldoses in Figure 15-7.

In addition, carboxylic acid derivatives of glucose are important, including D-glucuronate (for glucuronide formation and in glycosaminoglycans), its metabolic derivative, L-iduronate

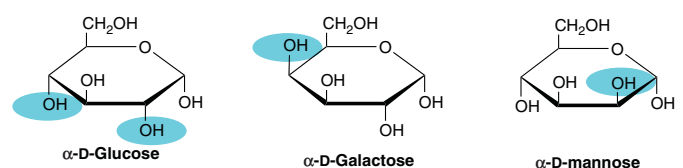

FIGURE 15-5 Epimers of glucose.

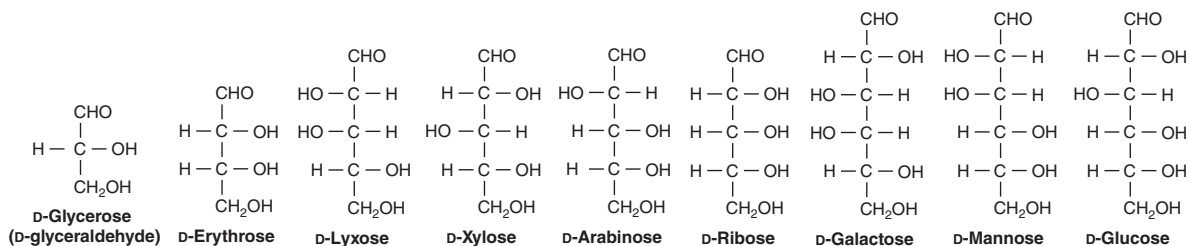

FIGURE 15-6 Examples of aldoses of physiological significance.

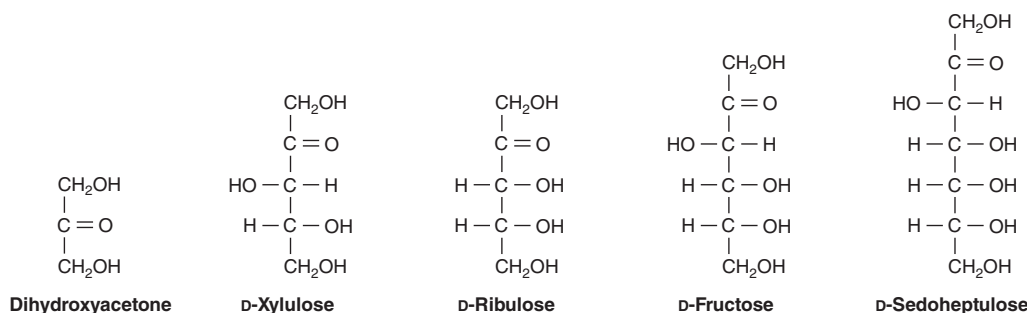

FIGURE 15-7 Examples of ketoses of physiological significance.

TABLE 15-2 Pentoses of Physiological Importance

Sugar	Source	Biochemical and Clinical Importance
D-Ribose	Nucleic acids and metabolic intermediate	Structural component of nucleic acids and coenzymes, including ATP, NAD(P), and flavin coenzymes
D-Ribulose	Metabolic intermediate	Intermediate in the pentose phosphate pathway
D-Arabinose	Plant gums	Constituent of glycoproteins
D-Xylose	Plant gums, proteoglycans, glycosaminoglycans	Constituent of glycoproteins
L-Xylulose	Metabolic intermediate	Excreted in the urine in essential pentosuria

(in glycosaminoglycans, **Figure 15-8**) and L-gulonate (an intermediate in the uronic acid pathway; see **Figure 20-4**).

Sugars Form Glycosides With Other Compounds & With Each Other

Glycosides are formed by condensation between the hydroxyl group of the anomeric carbon of a monosaccharide, and a second compound that may be another monosaccharide or, in the case of an **aglycone**, not a sugar. If the second group is also a hydroxyl, the O-glycosidic bond is an **acetal** link because it results from a reaction between a hemiacetal group (formed from an aldehyde and an —OH group) and another —OH group. If the hemiacetal portion is glucose, the resulting compound is a **glucoside**; if galactose, a **galactoside**; and so on. If the second group is an amine, an **N-glycosidic** bond is formed, for example, between adenine and ribose in nucleotides such as ATP (see **Figure 11-4**).

TABLE 15-3 Hexoses of Physiological Importance

Sugar	Source	Biochemical Importance	Clinical Significance
D-Glucose	Fruit juices, hydrolysis of starch, cane or beet sugar, maltose and lactose	The main metabolic fuel for tissues; “blood sugar”	Excreted in the urine (glucosuria) in poorly controlled diabetes mellitus as a result of hyperglycemia
D-Fructose	Fruit juices, honey, hydrolysis of cane or beet sugar and inulin, enzymic isomerization of glucose syrups for food manufacture	Readily metabolized either via glucose or directly	Hereditary fructose intolerance leads to fructose accumulation and hypoglycemia
D-Galactose	Hydrolysis of lactose	Readily metabolized to glucose; synthesized in the mammary gland for synthesis of lactose in milk. A constituent of glycolipids and glycoproteins	Hereditary galactosemia as a result of failure to metabolize galactose leads to cataracts
D-Mannose	Hydrolysis of plant mannan gums	Constituent of glycoproteins	

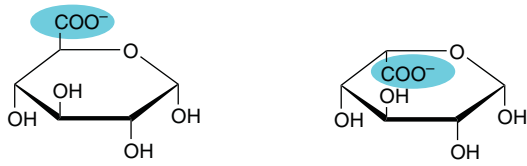

FIGURE 15-8 α -D-Glucuronate (left) and β -L-iduronate (right).

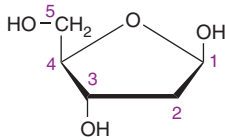

FIGURE 15-9 2-Deoxy-D-ribofuranose (β form).

Glycosides are widely distributed in nature; the aglycone may be methanol, glycerol, a sterol, a phenol, or a base such as adenine. The glycosides that are important in medicine because of their action on the heart (**cardiac glycosides**) all contain steroids as the aglycone. These include derivatives of digitalis and strophanthus such as **ouabain**, an inhibitor of the $\text{Na}^+ - \text{K}^+$ -ATPase of cell membranes. Other glycosides include antibiotics such as **streptomycin**.

Deoxy Sugars Lack an Oxygen Atom

Deoxy sugars are those in which one hydroxyl group has been replaced by hydrogen. An example is **deoxyribose** (Figure 15-9) in DNA. The deoxy sugar L-fucose (Figure 15-15) occurs in glycoproteins; 2-deoxyglucose is used experimentally as an inhibitor of glucose metabolism.

Amino Sugars (Hexosamines) Are Components of Glycoproteins, Gangliosides, & Glycosaminoglycans

The amino sugars include D-glucosamine, a constituent of hyaluronic acid (Figure 15-10), D-galactosamine (also known as chondrosamine), a constituent of chondroitin, and D-mannosamine. Several **antibiotics** (eg, **erythromycin**) contain amino sugars, which are important for their antibiotic activity.

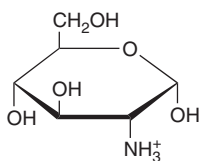

FIGURE 15-10 Glucosamine (2-amino-D-glucopyranose) (α form). Galactosamine is 2-amino-D-galactopyranose. Both glucosamine and galactosamine occur as N-acetyl derivatives in complex carbohydrates, for example, glycoproteins.

Maltose, Sucrose, & Lactose Are Important Disaccharides

The disaccharides are sugars composed of two monosaccharide residues linked by a glycoside bond (Figure 15-11). The physiologically important disaccharides are maltose, sucrose, and lactose (Table 15-4). Hydrolysis of sucrose yields a mixture of glucose and fructose called "invert sugar" because fructose is strongly levorotatory and changes (inverts) the weaker dextrorotatory action of sucrose.

POLYSACCHARIDES SERVE STORAGE & STRUCTURAL FUNCTIONS

Polysaccharides include a number of physiologically important carbohydrates.

Starch is a homopolymer of glucose forming an α -glucosidic chain, called a **glucosan** or **glucan**. It is the most important dietary carbohydrate in cereals, potatoes, legumes, and other vegetables. The two main constituents are **amylose** (13%-20%), which has a nonbranching helical structure, and **amylopectin** (80%-87%), which consists of branched chains consists of 24 to 30 glucose residues with $\alpha 1 \rightarrow 4$ linkages in the chains and by $\alpha 1 \rightarrow 6$ linkages at the branch points (Figure 15-12).

The extent to which starch in foods is hydrolyzed by amylase is determined by its structure, the degree of crystallization or hydration (the result of cooking), and whether it is enclosed in intact (and indigestible) plant cells walls. The **glycemic index** of a starchy food is a measure of its digestibility, based on the extent to which it raises the blood concentration of glucose compared with an equivalent amount of glucose or a reference food such as white bread or boiled rice. Glycemic index ranges from 1 (or 100%) for starches that are readily hydrolyzed in the small intestine to 0 for those that are not hydrolyzed at all.

Glycogen is the storage polysaccharide in animals and is sometimes called animal starch. It is a more highly branched structure than amylopectin, with chains of 12 to 15 α -D-glucopyranose residues (in $\alpha 1 \rightarrow 4$ glucosidic linkage) with branching by means of $\alpha 1 \rightarrow 6$ glucosidic bonds. Muscle glycogen granules (β -particles) are spherical and contain up to 60,000 glucose residues; in liver there are similar granules and also rosettes of glycogen granules that appear to be aggregated β -particles.

Inulin is a polysaccharide of fructose (a fructosan) found in tubers and roots of dahlias, artichokes, and dandelions. It is readily soluble in water and is used to determine the glomerular filtration rate (see Chapter 48), but it is not hydrolyzed by intestinal enzymes, so has no nutritional value. **Dextrins** are intermediates in the hydrolysis of starch. **Cellulose** is the chief constituent of plant cell walls. It is insoluble and consists of β -D-glucopyranose units linked by $\beta 1 \rightarrow 4$ bonds to form long, straight chains strengthened by cross-linking hydrogen bonds. Mammals lack any enzyme that hydrolyzes the $\beta 1 \rightarrow 4$

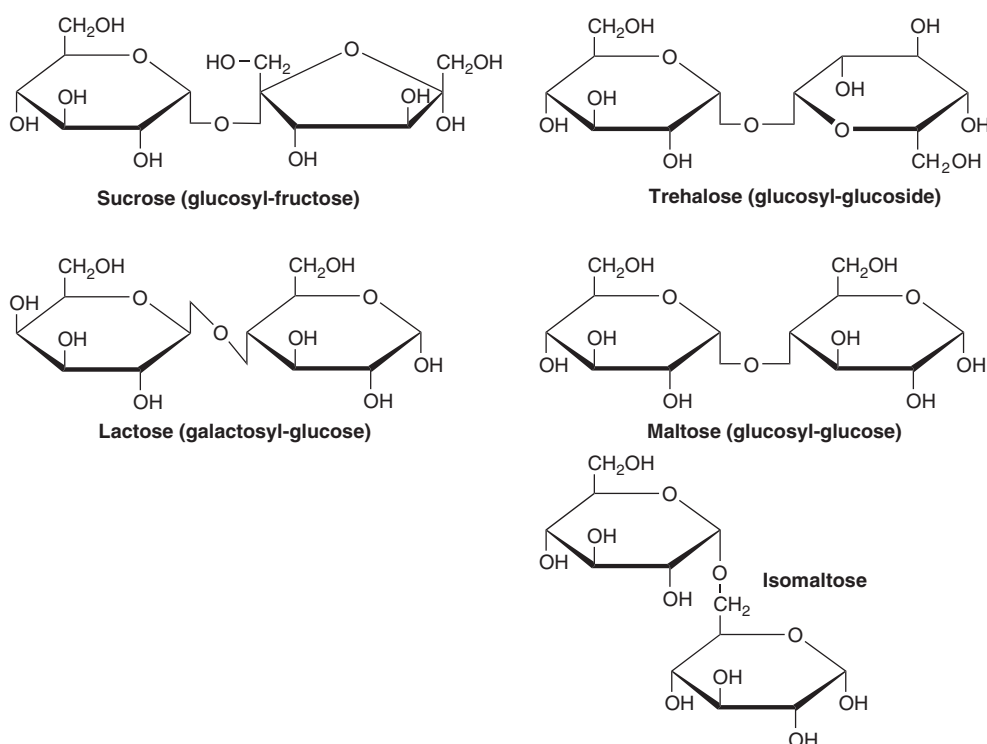
**FIGURE 15-11** Structures of nutritionally important disaccharides.**TABLE 15-4** Disaccharides of Physiological Importance

Sugar	Composition	Source	Clinical Significance
Sucrose	O- α -D-glucopyranosyl-(1 \rightarrow 2)- β -D-fructofuranoside	Cane and beet sugar, sorghum and some fruits and vegetables	Rare genetic lack of sucrase leads to sucrose intolerance—diarrhea and flatulence
Lactose	O- α -D-galactopyranosyl-(1 \rightarrow 4)- β -D-glucopyranose	Milk (and many pharmaceutical preparations as a filler)	Lack of lactase (lactasia) leads to lactose intolerance—diarrhea and flatulence; may be excreted in the urine in pregnancy
Maltose	O- α -D-glucopyranosyl-(1 \rightarrow 4)- α -D-glucopyranose	Enzymic hydrolysis of starch (amylase); germinating cereals and malt	
Isomaltose	O- α -D-glucopyranosyl-(1 \rightarrow 6)- α -D-glucopyranose	Enzymic hydrolysis of starch (the branch points in amylopectin)	
Lactulose	O- α -D-galactopyranosyl-(1 \rightarrow 4)- β -D-fructofuranose	Heated milk (small amounts), mainly synthetic	Not hydrolyzed by intestinal enzymes, but fermented by intestinal bacteria; used as a mild osmotic laxative
Trehalose	O- α -D-glucopyranosyl-(1 \rightarrow 1)- α -D-glucopyranoside	Yeasts and fungi; the main sugar of insect hemolymph	

bonds, and so cannot digest cellulose. It is an important source of “bulk” in the diet, and the major component of dietary fiber. Microorganisms in the gut of ruminants and other herbivores can hydrolyze the linkage and ferment the products to short-chain fatty acids as a major energy source. There is some bacterial metabolism of cellulose in the human colon. **Chitin** is a structural polysaccharide in the exoskeleton of crustaceans and insects, and also in mushrooms. It consists of *N*-acetyl-D-

glucosamine units joined by β 1 \rightarrow 4 glycosidic bonds. **Pectin** occurs in fruits; it is a polymer of galacturonic acid linked α -1 \rightarrow 4, with some galactose an/or arabinose branches, and is partially methylated (**Figure 15-13**).

Glycosaminoglycans (mucopolysaccharides) are complex carbohydrates containing **amino sugars** and **uronic acids**. They may be attached to a protein molecule to form a **proteoglycan**. Proteoglycans provide the ground or packing

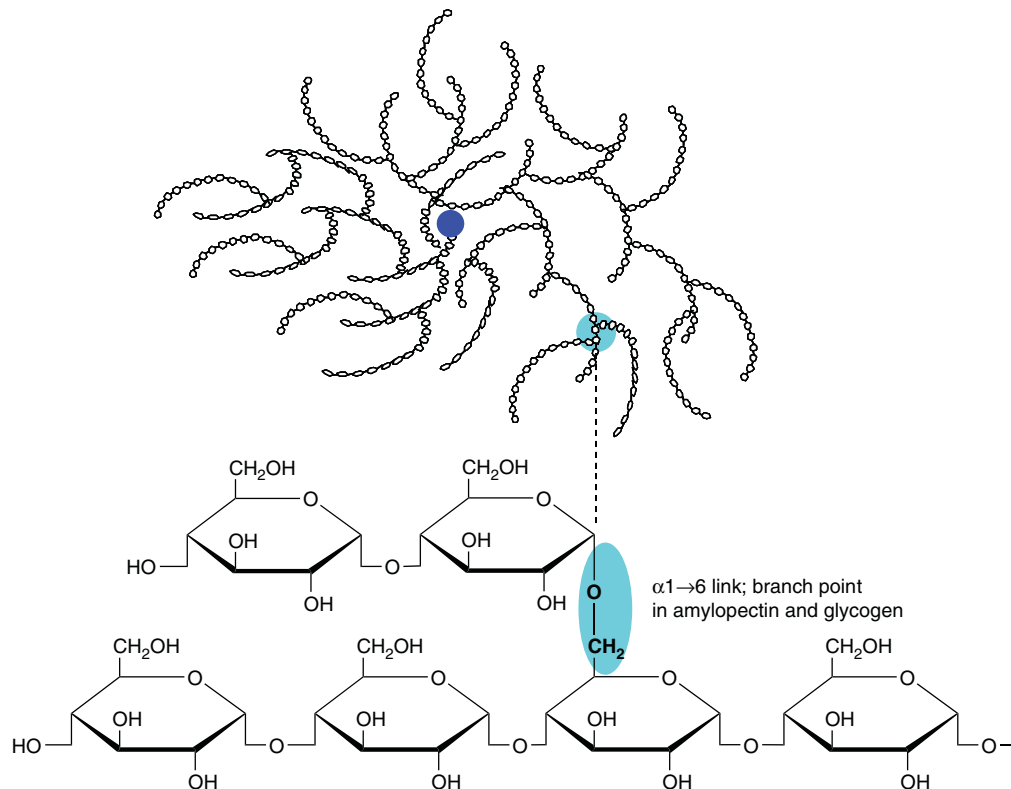

FIGURE 15-12 The structure of starch and glycogen. Amylose is a linear polymer of glucose residues linked α 1 \rightarrow 4, which coils into a helix. Amylopectin and glycogen consist of short chains of glucose residues linked α 1 \rightarrow 4 with branch points formed by α 1 \rightarrow 6 glycoside bonds. The glycogen molecule is a sphere \sim 21 nm in diameter that can be seen in electron micrographs. It has a molecular mass of \sim 10^7 Da and consists of polysaccharide chains, each containing about 13 glucose residues. The chains are either branched or unbranched and are arranged in 12 concentric layers. The branched chains (each has two branches) are found in the inner layers and the unbranched chains in the outermost layer. The blue dot at the center of the glycogen molecule is glycogenin, the primer molecule for glycogen synthesis.

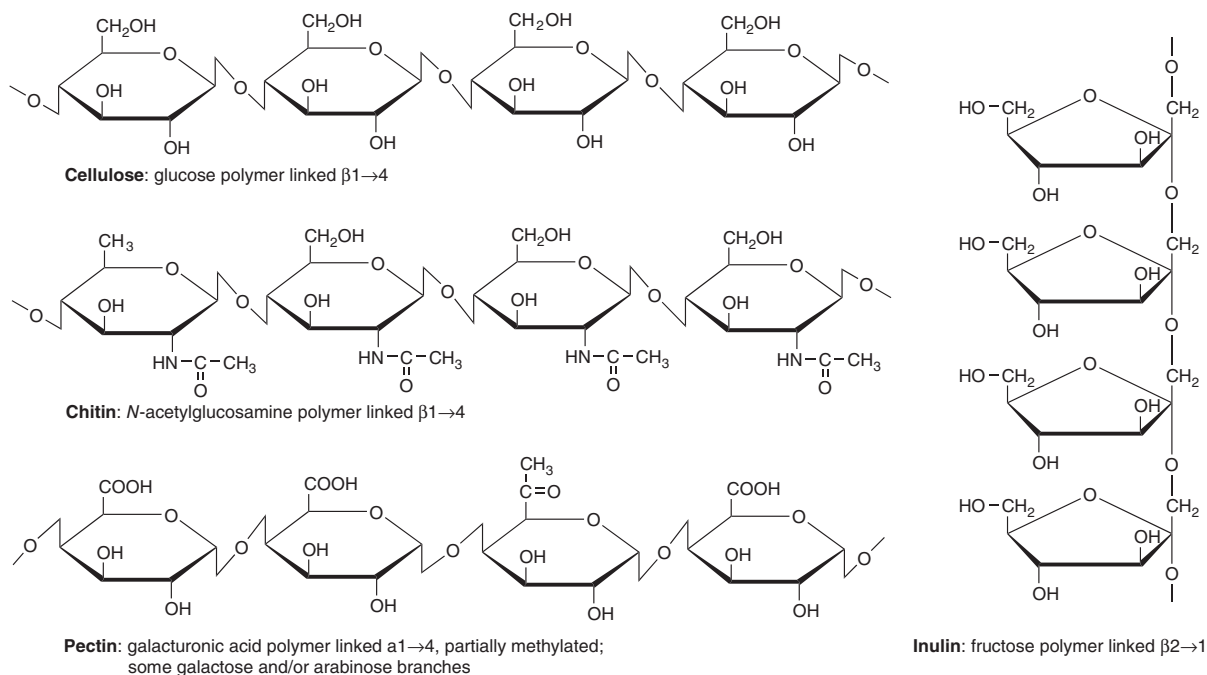

FIGURE 15-13 The structures of some important nonstarch polysaccharides.

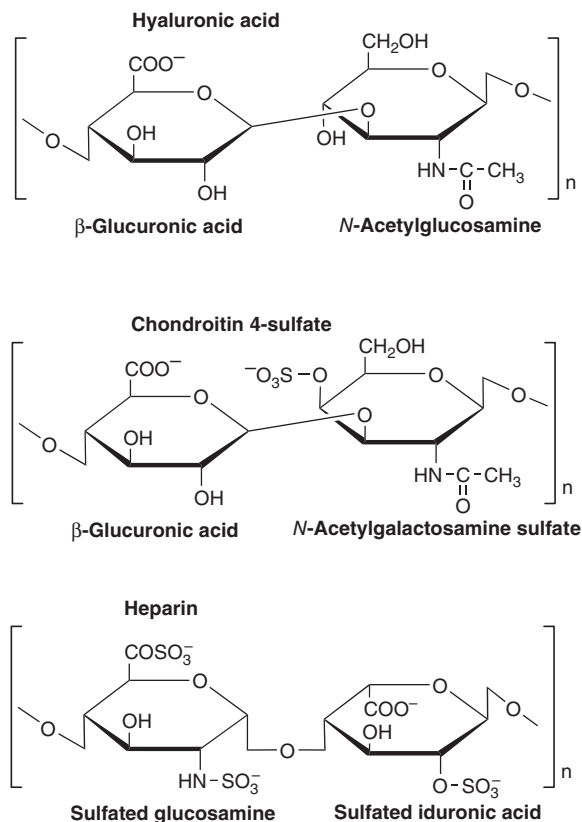

FIGURE 15-14 Structure of some complex polysaccharides and glycosaminoglycans.

substance of connective tissue (see Chapter 50). They hold large quantities of water and occupy space, thus cushioning or lubricating other structures, because of the large number of —OH groups and negative charges on the molecule, which, by repulsion, keep the carbohydrate chains apart. Examples are **hyaluronic acid**, **chondroitin sulfate**, and **heparin** (Figure 15-14).

Glycoproteins (also known as mucoproteins) are proteins containing branched or unbranched oligosaccharide chains (Table 15-5), including **fucose** (Figure 15-15). They occur in cell membranes (see Chapters 40 and 46) and many proteins are glycosylated. The **sialic acids** are *N*- or *O*-acyl derivatives

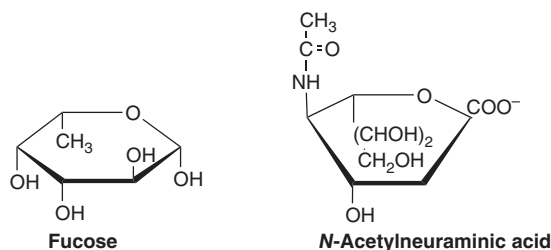

FIGURE 15-15 β -L-Fucose (6-deoxy- β -L-galactose) and *N*-acetylneuraminic acid, a sialic acid.

of neuraminic acid (Figure 15-15). **Neuraminic acid** is a nine-carbon sugar derived from mannosamine (an epimer of glucosamine) and pyruvate. Sialic acids are constituents of both **glycoproteins** and **gangliosides**.

CARBOHYDRATES OCCUR IN CELL MEMBRANES & IN LIPOPROTEINS

Approximately 5% of the weight of cell membranes is the carbohydrate part of glycoproteins (see Chapter 46) and glycolipids. Their presence on the outer surface of the plasma membrane (the **glycocalyx**) has been shown with the use of plant **lectins**, proteins that bind specific glycosyl residues. For example, **concanavalin A** binds α -glucosyl and α -mannosyl residues. **Glycophorin** is a major integral membrane glycoprotein of human erythrocytes. It has 130 amino acid residues and spans the lipid membrane, with polypeptide regions outside both the external and internal (cytoplasmic) surfaces. Carbohydrate chains are attached to the amino terminal portion outside the external surface. Carbohydrates are also present in apo-protein B of plasma lipoproteins.

SUMMARY

- The glycome is the entire complement of sugars of an organism, whether free or present in more complex molecules. Glycomics is the study of glycomes, including genetic, physiological, pathological, and other aspects.
- Carbohydrates are major constituents of animal food and animal tissues. They are characterized by the type and number of monosaccharide residues in their molecules.
- Glucose is the most important carbohydrate in mammalian biochemistry because nearly all carbohydrate in food is converted to glucose for metabolism.
- Sugars have large numbers of stereoisomers because they contain several asymmetric carbon atoms.
- The physiologically important monosaccharides include glucose, the "blood sugar," and ribose, an important constituent of nucleotides and nucleic acids.
- The important disaccharides include maltose (glucosyl-glucose), an intermediate in the digestion of starch; sucrose

TABLE 15-5 Carbohydrates Found in Glycoproteins

Hexoses	Mannose (Man), Galactose (Gal)
Acetyl hexosamines	<i>N</i> -Acetylglucosamine (GlcNAc), <i>N</i> -acetylgalactosamine (GalNAc)
Pentoses	Arabinose (Ara), Xylose (Xyl)
Methyl pentose	L-Fucose (Fuc, see Figure 15-15)
Sialic acids	<i>N</i> -Acyl derivatives of neuraminic acid; the predominant sialic acid is <i>N</i> -acetylneuraminic acid (NeuAc, see Figure 15-16)

(glucosyl-fructose), important as a dietary constituent containing fructose; and lactose (galactosyl-glucose), in milk.

- Starch and glycogen are storage polymers of glucose in plants and animals, respectively. Starch is the major metabolic fuel in the diet.
- Complex carbohydrates contain other sugar derivatives such as amino sugars, uronic acids, and sialic acids. They include proteoglycans and glycosaminoglycans, which are associated with structural elements of the tissues, and glycoproteins, which are proteins containing oligosaccharide chains; they are found in many situations including the cell membrane.
- Oligosaccharide chains encode biological information, depending on their constituent sugars and their sequence and linkages.

REFERENCES

- Champ M, Langkilde A-M, Brouns F, et al: Advances in dietary fibre characterisation. *Nutrition Res Rev* 2003;16:(1)71–82.
- Davis BG, Fairbanks AJ: *Carbohydrate Chemistry*. Oxford University Press, 2002.
- Garg HC, Cowman KM, Hales CA: *Carbohydrate Chemistry, Biology and Medical Applications*. Elsevier, 2008.
- Kiessling LL, Splain RA: Chemical approaches to glycobiology. *Ann Rev Biochem* 2010;79:619–653.
- Lindhorst TK, Thisbe K: *Essentials of Carbohydrate Chemistry and Biochemistry*, 3rd ed. Wiley-VCH, 2007.
- Sinnott M: *Carbohydrate Chemistry and Biochemistry: Structure and Mechanisms*, Royal Society of Chemistry, 2007.

The Citric Acid Cycle: The Central Pathway of Carbohydrate, Lipid & Amino Acid Metabolism

David A. Bender, PhD & Peter A. Mayes, PhD, DSc

OBJECTIVES

*After studying this chapter,
you should be able to:*

- Describe the reactions of the citric acid cycle and the reactions that lead to the production of reducing equivalents that are oxidized in the mitochondrial electron transport chain to yield ATP.
- Explain the importance of vitamins in the citric acid cycle.
- Explain how the citric acid cycle provides both a route for catabolism of amino acids and also a route for their synthesis.
- Describe the main anaplerotic pathways that permit replenishment of citric acid cycle intermediates, and how the withdrawal of oxaloacetate for gluconeogenesis is controlled.
- Describe the role of the citric acid cycle in fatty acid synthesis.
- Explain how the activity of the citric acid cycle is controlled by the availability of oxidized cofactors.
- Explain how hyperammonemia can lead to loss of consciousness.

BIOMEDICAL IMPORTANCE

The citric acid cycle (the Krebs or tricarboxylic acid cycle) is a sequence of reactions in mitochondria that oxidizes the acetyl moiety of acetyl-CoA to CO₂ and reduces coenzymes that are reoxidized through the electron transport chain (see Chapter 13), linked to the formation of ATP.

The citric acid cycle is the final common pathway for the oxidation of carbohydrate, lipid, and protein because glucose, fatty acids, and most amino acids are metabolized to acetyl-CoA or intermediates of the cycle. It also has a central role in gluconeogenesis, lipogenesis, and interconversion of amino acids. Many of these processes occur in most tissues, but liver is the only tissue in which all occur to a significant extent. The repercussions are therefore profound when, for example, large numbers of hepatic cells are damaged as in acute **hepatitis** or replaced by connective tissue (as in **cirrhosis**). The few genetic defects of citric acid cycle enzymes that have been reported are associated with severe neurological damage as a result of very considerably impaired ATP formation in the central nervous system.

Hyperammonemia, as occurs in advanced liver disease, leads to loss of consciousness, coma, and convulsions as a result of impaired activity of the citric acid cycle, leading to reduced formation of ATP. Ammonia both depletes citric acid cycle intermediates (by withdrawing α -ketoglutarate for the formation of glutamate and glutamine) and also inhibits the oxidative decarboxylation of α -ketoglutarate.

THE CITRIC ACID CYCLE PROVIDES SUBSTRATES FOR THE RESPIRATORY CHAIN

The cycle starts with reaction between the acetyl moiety of acetyl-CoA and the four-carbon dicarboxylic acid oxaloacetate, forming a six-carbon tricarboxylic acid, citrate. In the subsequent reactions, two molecules of CO₂ are released and oxaloacetate is regenerated (**Figure 16-1**). Only a small quantity of oxaloacetate is needed for the oxidation of a large

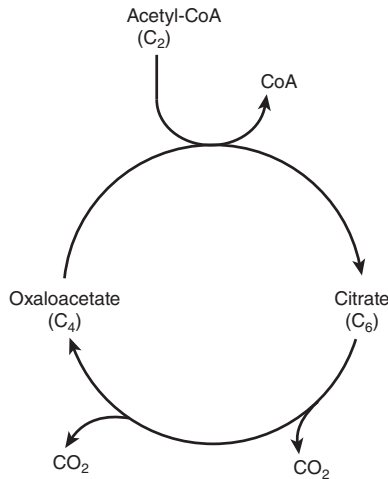

FIGURE 16-1 The citric acid cycle, illustrating the catalytic role of oxaloacetate.

quantity of acetyl-CoA; it can be considered as playing a **catalytic role**, since it is regenerated at the end of the cycle.

The citric acid cycle provides the main pathway for ATP formation linked to the oxidation of metabolic fuels. During the oxidation of acetyl-CoA, coenzymes are reduced and subsequently reoxidized in the respiratory chain, linked to the formation of ATP (oxidative phosphorylation, **Figure 16-2**; see also Chapter 13). This process is **aerobic**, requiring oxygen as the final oxidant of the reduced coenzymes. The enzymes of the citric acid cycle are located in the **mitochondrial matrix**, either free or attached to the inner mitochondrial membrane and the crista membrane, where the enzymes and coenzymes of the respiratory chain are also found (see Chapter 13).

REACTIONS OF THE CITRIC ACID CYCLE LIBERATE REDUCING EQUIVALENTS & CO₂

The initial reaction between acetyl-CoA and oxaloacetate to form citrate is catalyzed by **citrate synthase**, which forms a carbon-carbon bond between the methyl carbon of acetyl-CoA and the carbonyl carbon of oxaloacetate (**Figure 16-3**). The thioester bond of the resultant citryl-CoA is hydrolyzed, releasing citrate and CoASH—an exothermic reaction.

Citrate is isomerized to isocitrate by the enzyme **aconitase** (aconitate hydratase); the reaction occurs in two steps: dehydration to *cis*-aconitate and rehydration to isocitrate. Although citrate is a symmetric molecule, aconitase reacts with citrate asymmetrically, so that the two carbon atoms that are lost in subsequent reactions of the cycle are not those that were added from acetyl-CoA. This asymmetric behavior is the result of **channeling**—transfer of the product of citrate synthase directly onto the active site of aconitase, without entering free solution. This provides integration of citric acid cycle activity and the provision of citrate in the cytosol as a source of acetyl-CoA for fatty acid synthesis. Citrate is only available in

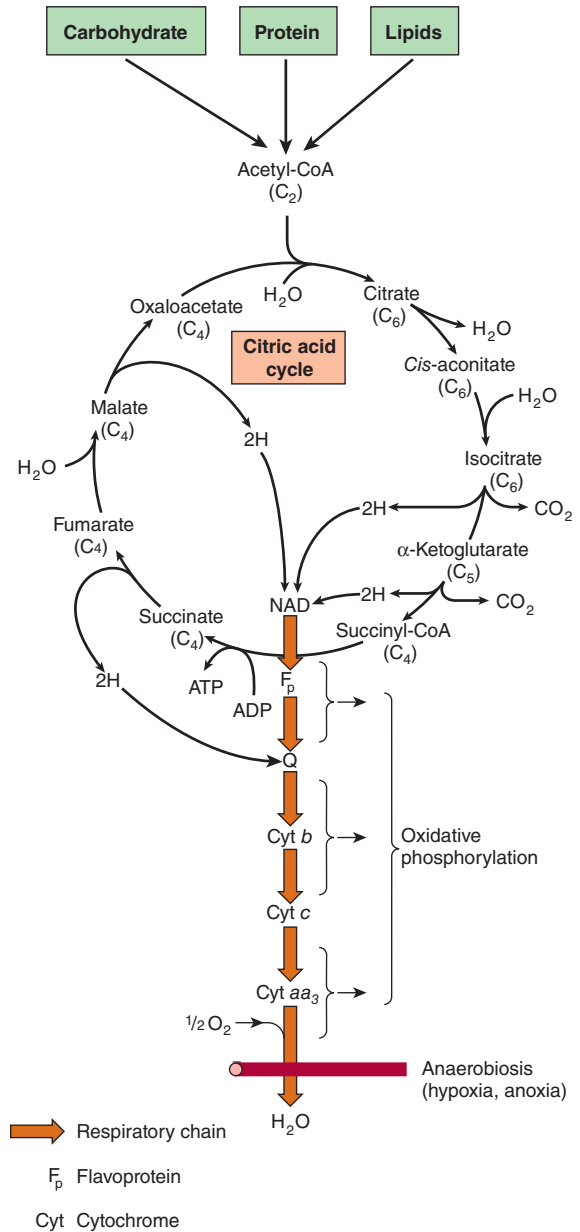

FIGURE 16-2 The citric acid cycle: the major catabolic pathway for acetyl-CoA. Acetyl-CoA, the product of carbohydrate, protein, and lipid catabolism, enters the cycle by forming citrate, and is oxidized to CO₂ with the reduction of coenzymes. Reoxidation of the coenzymes in the respiratory chain leads to phosphorylation of ADP to ATP. For one turn of the cycle, nine ATP are generated via oxidative phosphorylation and one ATP (or GTP) arises at substrate level from the conversion of succinyl-CoA to succinate.

free solution to be transported from the mitochondria to the cytosol for fatty acid synthesis when aconitase is inhibited by accumulation of its product, isocitrate.

The poison **fluoroacetate** is found in some of plants, and their consumption can be fatal to grazing animals. Some fluorinated compounds used as anticancer agents and industrial chemicals (including pesticides) are metabolized to fluoroacetate. It is toxic because fluoroacetyl-CoA condenses with oxaloacetate to form fluorocitrate, which inhibits aconitase, causing citrate to accumulate.

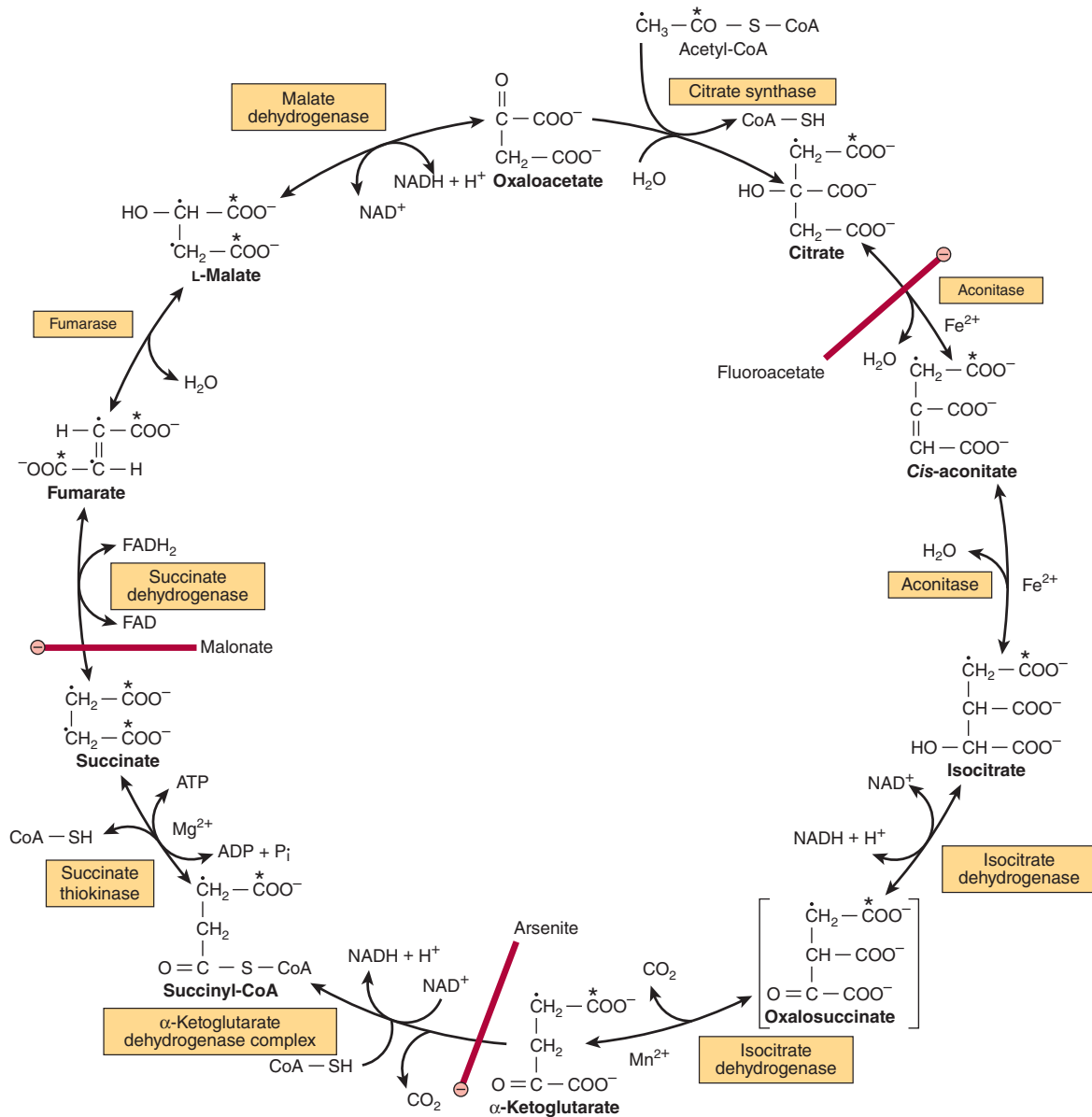

FIGURE 16-3 The citric acid (Krebs) cycle. Oxidation of NADH and FADH_2 in the respiratory chain leads to the formation of ATP via oxidative phosphorylation. In order to follow the passage of acetyl-CoA through the cycle, the two carbon atoms of the acetyl moiety are shown labeled on the carboxyl carbon (*) and on the methyl carbon (·). Although two carbon atoms are lost as CO_2 in one turn of the cycle, these atoms are not derived from the acetyl-CoA that has immediately entered the cycle, but from that portion of the citrate molecule that was derived from oxaloacetate. However, on completion of a single turn of the cycle, the oxaloacetate that is regenerated is now labeled, which leads to labeled CO_2 being evolved during the second turn of the cycle. Because succinate is a symmetric compound, “randomization” of label occurs at this step so that all four carbon atoms of oxaloacetate appear to be labeled after one turn of the cycle. During gluconeogenesis, some of the label in oxaloacetate is incorporated into glucose and glycogen (Figure 20-1). The sites of inhibition (⊖) by fluoroacetate, malonate, and arsenite are indicated.

Isocitrate undergoes dehydrogenation catalyzed by **isocitrate dehydrogenase** to form, initially, oxalosuccinate, which remains enzyme bound and undergoes decarboxylation to α -ketoglutarate. The decarboxylation requires Mg^{2+} or Mn^{2+} ions. There are three isoenzymes of isocitrate dehydrogenase. One, which uses NAD^+ , is found only in mitochondria. The other two use NADP^+ and are found in mitochondria and the cytosol. Respiratory-chain-linked oxidation of isocitrate occurs through the NAD^+ -dependent enzyme.

α -Ketoglutarate undergoes **oxidative decarboxylation** in a reaction catalyzed by a multienzyme complex similar to that involved in the oxidative decarboxylation of pyruvate (see Figure 17-5). The **α -ketoglutarate dehydrogenase complex** requires the same cofactors as the pyruvate dehydrogenase complex—thiamin diphosphate, lipoate, NAD^+ , FAD , and CoA —and results in the formation of succinyl-CoA. The equilibrium of this reaction is so much in favor of succinyl-CoA formation that it must be considered to be physiologically unidirectional. As in

the case of pyruvate oxidation (Chapter 17), arsenite inhibits the reaction, causing the substrate, α -ketoglutarate, to accumulate. High concentrations of ammonia inhibit α -ketoglutarate dehydrogenase.

Succinyl-CoA is converted to succinate by the enzyme **succinate thiokinase (succinyl-CoA synthetase)**. This is the only example of substrate level phosphorylation in the citric acid cycle. Tissues in which gluconeogenesis occurs (the liver and kidney) contain two isoenzymes of succinate thiokinase, one specific for GDP and the other for ADP. The GTP formed is used for the decarboxylation of oxaloacetate to phosphoenolpyruvate in gluconeogenesis, and provides a regulatory link between citric acid cycle activity and the withdrawal of oxaloacetate for gluconeogenesis. Nongluconeogenic tissues have only the isoenzyme that phosphorylates ADP.

When ketone bodies are being metabolized in extrahepatic tissues, there is an alternative reaction catalyzed by **succinyl-CoA-acetoacetate-CoA transferase (thiophorase)**, involving transfer of CoA from succinyl-CoA to acetoacetate, forming acetoacetyl-CoA and succinate (see Chapter 22).

The onward metabolism of succinate, leading to the regeneration of oxaloacetate, is the same sequence of chemical reactions as occurs in the β -oxidation of fatty acids: dehydrogenation to form a carbon-carbon double bond, addition of water to form a hydroxyl group, and a further dehydrogenation to yield the oxo-group of oxaloacetate.

The first dehydrogenation reaction, forming fumarate, is catalyzed by **succinate dehydrogenase**, which is bound to the inner surface of the inner mitochondrial membrane. The enzyme contains FAD and iron-sulfur (Fe-S) protein, and directly reduces ubiquinone in the electron transport chain. **Fumarase (fumarate hydratase)** catalyzes the addition of water across the double bond of fumarate, yielding malate. Malate is oxidized to oxaloacetate by **malate dehydrogenase**, linked to the reduction of NAD^+ . Although the equilibrium of this reaction strongly favors malate, the net flux is to oxaloacetate because of the continual removal of oxaloacetate (to form citrate, as a substrate for gluconeogenesis, or to undergo transamination to aspartate) and also the continual reoxidation of NADH.

TEN ATP ARE FORMED PER TURN OF THE CITRIC ACID CYCLE

As a result of oxidations catalyzed by the dehydrogenases of the citric acid cycle, three molecules of NADH and one of FADH_2 are produced for each molecule of acetyl-CoA catabolized in one turn of the cycle. These reducing equivalents are transferred to the respiratory chain (see Figure 13–3), where reoxidation of each NADH results in formation of ~ 2.5 ATP, and of FADH_2 , ~ 1.5 ATP. In addition, 1 ATP (or GTP) is formed by substrate-level phosphorylation catalyzed by succinate thiokinase.

VITAMINS PLAY KEY ROLES IN THE CITRIC ACID CYCLE

Four of the B vitamins (see Chapter 44) are essential in the citric acid cycle and hence energy-yielding metabolism: **riboflavin**, in the form of flavin adenine dinucleotide (FAD), a cofactor for succinate dehydrogenase; **niacin**, in the form of nicotinamide adenine dinucleotide (NAD^+), the electron acceptor for isocitrate dehydrogenase, α -ketoglutarate dehydrogenase, and malate dehydrogenase; thiamin (**vitamin B₁**), as thiamin diphosphate, the coenzyme for decarboxylation in the α -ketoglutarate dehydrogenase reaction; and **pantothenic acid**, as part of coenzyme A, the cofactor esterified to “active” carboxylic acid residues: acetyl-CoA and succinyl-CoA.

THE CITRIC ACID CYCLE PLAYS A PIVOTAL ROLE IN METABOLISM

The citric acid cycle is not only a pathway for oxidation of two carbon units, but is also a major pathway for interconversion of metabolites arising from **transamination** and **deamination** of amino acids (see Chapters 28 and 29), and providing the substrates for **amino acid synthesis** by transamination (see Chapter 27), as well as for **gluconeogenesis** (see Chapter 19) and **fatty acid synthesis** (see Chapter 23). Because it functions in both oxidative and synthetic processes, it is **amphibolic** (Figure 16–4).

The Citric Acid Cycle Takes Part in Gluconeogenesis, Transamination, & Deamination

All the intermediates of the cycle are potentially **glucogenic**, since they can give rise to oxaloacetate, and hence net production of glucose (in the liver and kidney, the organs that carry out gluconeogenesis; see Chapter 19). The key enzyme that catalyzes net transfer out of the cycle into gluconeogenesis is **phosphoenolpyruvate carboxykinase**, which catalyzes the decarboxylation of oxaloacetate to phosphoenolpyruvate, with GTP acting as the phosphate donor (see Figure 19–1). The GTP required for this reaction is provided by the GDP-dependent isoenzyme of succinate thiokinase. This ensures that oxaloacetate will not be withdrawn from the cycle for gluconeogenesis if this would lead to depletion of citric acid cycle intermediates, and hence reduced generation of ATP.

Net transfer into the cycle occurs as a result of several reactions. Among the most important of such **anaplerotic** reactions is the formation of oxaloacetate by the carboxylation of pyruvate, catalyzed by **pyruvate carboxylase** (Figure 16–4). This reaction is important in maintaining an adequate concentration of oxaloacetate for the condensation reaction with acetyl-CoA. If acetyl-CoA accumulates, it acts as both an allosteric

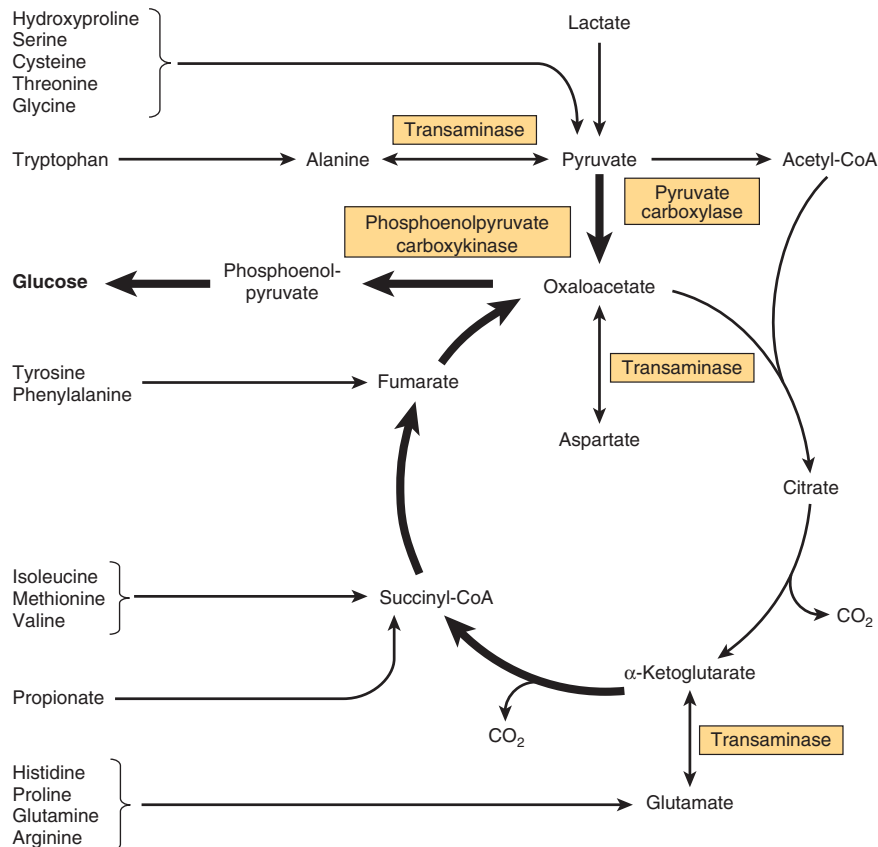

FIGURE 16-4 Involvement of the citric acid cycle in transamination and gluconeogenesis. The bold arrows indicate the main pathway of gluconeogenesis.

activator of pyruvate carboxylase and an inhibitor of pyruvate dehydrogenase, thereby ensuring a supply of oxaloacetate. Lactate, an important substrate for gluconeogenesis, enters the cycle via oxidation to pyruvate and then carboxylation to oxaloacetate. **Glutamate** and **glutamine** are important anaplerotic substrates because they yield α -ketoglutarate as a result of the reactions catalyzed by glutaminase and glutamate dehydrogenase. Transamination of **aspartate** leads directly to the formation of oxaloacetate, and a variety of compounds that are metabolized to yield **propionyl CoA**, which can be carboxylated and isomerized to succinyl CoA are also important anaplerotic substrates.

Aminotransferase (transaminase) reactions form pyruvate from alanine, oxaloacetate from aspartate, and α -ketoglutarate from glutamate. Because these reactions are reversible, the cycle also serves as a source of carbon skeletons for the synthesis of these amino acids. Other amino acids contribute to gluconeogenesis because their carbon skeletons give rise to citric acid cycle intermediates. Alanine, cysteine, glycine, hydroxyproline, serine, threonine, and tryptophan yield pyruvate; arginine, histidine, glutamine, and proline yield α -ketoglutarate; isoleucine, methionine, and valine yield succinyl-CoA; tyrosine and phenylalanine yield fumarate (see Figure 16-4).

The citric acid cycle itself does not provide a pathway for the complete oxidation of the carbon skeletons of amino acids that

give rise to intermediates such as α -ketoglutarate, succinyl CoA, fumarate and oxaloacetate, because this results in an increase in the amount of oxaloacetate. For complete oxidation to occur, oxaloacetate must undergo phosphorylation and carboxylation to phosphoenolpyruvate (at the expense of GTP) then dephosphorylation to pyruvate (catalyzed by pyruvate kinase) and oxidative decarboxylation to acetyl CoA (catalyzed by pyruvate dehydrogenase).

In ruminants, whose main metabolic fuel is short-chain fatty acids formed by bacterial fermentation, the conversion of propionate, the major glucogenic product of rumen fermentation, to succinyl-CoA via the methylmalonyl-CoA pathway (see Figure 19-2) is especially important.

The Citric Acid Cycle Takes Part in Fatty Acid Synthesis

Acetyl-CoA, formed from pyruvate by the action of pyruvate dehydrogenase, is the major substrate for long-chain fatty acid synthesis in nonruminants (**Figure 16-5**). (In ruminants, acetyl-CoA is derived directly from acetate.) Pyruvate dehydrogenase is a mitochondrial enzyme, and fatty acid synthesis is a cytosolic pathway; the mitochondrial membrane is impermeable to acetyl-CoA. For acetyl-CoA to be available in the cytosol, citrate is transported from the mitochondrion to the cytosol, then cleaved

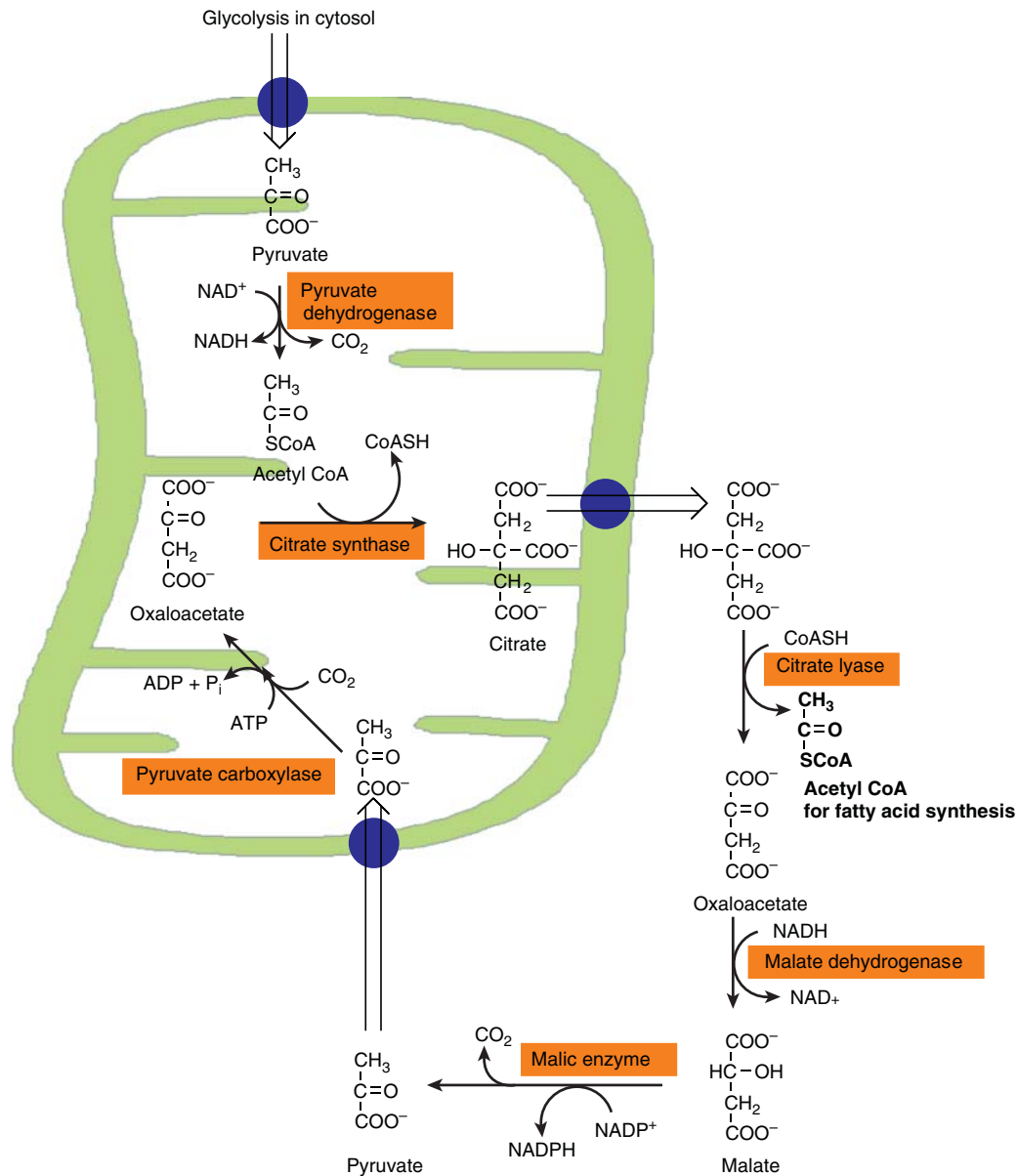

FIGURE 16-5 Participation of the citric acid cycle in provision of cytosolic acetyl CoA for fatty acid synthesis from glucose. See also Figure 23-5.

in a reaction catalyzed by **citrate lyase** (Figure 16-5). Citrate is only available for transport out of the mitochondrion when aconitase is inhibited by its product and therefore saturated with its substrate, so that citrate cannot be channeled directly from citrate synthase onto aconitase. This ensures that citrate is used for fatty acid synthesis only when there is an adequate amount to ensure continued activity of the cycle.

The oxaloacetate released by citrate lyase cannot reenter the mitochondrion, but is reduced to malate, at the expense of NADH , and the malate undergoes oxidative decarboxylation to pyruvate, reducing NADP^+ to NADPH . This reaction, catalyzed by the malic enzyme, is the source of half the NADPH required for fatty acid synthesis (the remainder is provided by the pentose phosphate pathway, Chapter 20). Pyruvate enters the mitochondrion and is carboxylated to oxaloacetate by

pyruvate carboxylase, an ATP-dependent reaction in which the coenzyme is the vitamin biotin.

Regulation of the Citric Acid Cycle Depends Primarily on a Supply of Oxidized Cofactors

In most tissues, where the primary role of the citric acid cycle is in energy-yielding metabolism, **respiratory control** via the respiratory chain and oxidative phosphorylation regulates citric acid cycle activity (see Chapter 13). Thus, activity is immediately dependent on the supply of NAD^+ , which in turn, because of the tight coupling between oxidation and phosphorylation, is dependent on the availability of ADP and hence, ultimately on the rate of utilization of ATP in chemical and physical work.

In addition, individual enzymes of the cycle are regulated. The main sites for regulation are the nonequilibrium reactions catalyzed by pyruvate dehydrogenase, citrate synthase, isocitrate dehydrogenase, and α -ketoglutarate dehydrogenase. The dehydrogenases are activated by Ca^{2+} , which increases in concentration during contraction of muscle and during secretion by other tissues, when there is increased energy demand. In a tissue such as brain, which is largely dependent on carbohydrate to supply acetyl-CoA, control of the citric acid cycle may occur at pyruvate dehydrogenase. Several enzymes are responsive to the energy status as shown by the $[\text{ATP}]/[\text{ADP}]$ and $[\text{NADH}]/[\text{NAD}^+]$ ratios. Thus, there is allosteric inhibition of citrate synthase by ATP and long-chain fatty acyl-CoA. Allosteric activation of mitochondrial NAD-dependent isocitrate dehydrogenase by ADP is counteracted by ATP and NADH. The α -ketoglutarate dehydrogenase complex is regulated in the same way as is pyruvate dehydrogenase (Figure 17–6). Succinate dehydrogenase is inhibited by oxaloacetate, and the availability of oxaloacetate, as controlled by malate dehydrogenase, depends on the $[\text{NADH}]/[\text{NAD}^+]$ ratio. Since the K_m of citrate synthase for oxaloacetate is of the same order of magnitude as the intramitochondrial concentration, it is likely that the concentration of oxaloacetate controls the rate of citrate formation.

Hyperammonemia, as occurs in advanced liver disease and a number of (rare) genetic diseases of amino acid metabolism, leads to loss of consciousness, coma and convulsions, and may be fatal. This is largely because of the withdrawal of α -ketoglutarate to form glutamate (catalyzed by glutamate dehydrogenase) and then glutamine (catalyzed by glutamine synthetase), leading to lowered concentrations of all citric acid cycle intermediates, and hence reduced generation of ATP. The equilibrium of glutamate dehydrogenase is finely poised, and the direction of reaction depends on the ratio of $\text{NAD}^+:\text{NADH}$ and the concentration of ammonium ions. In addition, ammonia inhibits α -ketoglutarate dehydrogenase, and possibly also pyruvate dehydrogenase.

SUMMARY

- The citric acid cycle is the final pathway for the oxidation of carbohydrate, lipid, and protein. Their common end-metabolite, acetyl-CoA, reacts with oxaloacetate to form citrate. By a series of dehydrogenations and decarboxylations, citrate is degraded, reducing coenzymes, releasing two CO_2 , and regenerating oxaloacetate.
- The reduced coenzymes are oxidized by the respiratory chain linked to formation of ATP. Thus, the cycle is the major pathway for the formation of ATP and is located in the matrix of mitochondria adjacent to the enzymes of the respiratory chain and oxidative phosphorylation.

- The citric acid cycle is amphibolic, since in addition to oxidation it is important in the provision of carbon skeletons for gluconeogenesis, acetyl CoA for fatty acid synthesis, and interconversion of amino acids.

REFERENCES

- Baldwin JE, Krebs HA: The evolution of metabolic cycles. *Nature* 1981;291:381.
- Bender DA: The metabolism of “surplus” amino acids. *Br J Nutr* 2012;108(suppl 2): S113.
- Bowtell JL, Bruce M: Glutamine: an anaplerotic precursor. *Nutrition* 2002;18:222.
- Briere JJ, Favier J, Gimenez-Roqueplo A-P, et al: Tricarboxylic acid cycle dysfunction as a cause of human diseases and tumor formation. *Am J Physiol Cell Physiol* 2006;291:C1114.
- Brunengraber H, Roe CR: Anaplerotic molecules: current and future. *J Inher Metab Dis* 2006;29:327.
- De Meirleir L: Defects of pyruvate metabolism and the Krebs cycle. *J Child Neurol* 2002;(suppl 3):S26.
- Depeint F, Bruce WR: Mitochondrial function and toxicity: role of the B vitamin family on mitochondrial energy metabolism. *Chem Biol Interact* 2006;163:94.
- Gibala MJ, Young ME: Anaplerosis of the citric acid cycle: role in energy metabolism of heart and skeletal muscle. *Acta Physiol Scand* 2000;168:657.
- Grunengraber H, Roe CR: Anaplerotic molecules: current and future. *J Inher Metab Dis* 2006;29:327.
- Hertz L, Kala G: Energy metabolism in brain cells: effects of elevated ammonia concentrations. *Metab Brain Dis* 2007; 22:199–218.
- Jitrapakdee S, St Maurice M, Rayment I, et al: Structure, mechanism and regulation of pyruvate carboxylase. *Biochem J* 2008;413:369.
- Jitrapakdee S, Vidal-Puig A, Wallace JC: Anaplerotic roles of pyruvate carboxylase in mammalian tissues. *Cell Mol Life Sci* 2006;63:843.
- Kay J, Weitzman PDJ (editors): *Krebs' Citric Acid Cycle—Half a Century and Still Turning*. Biochemical Society, 1987.
- Kornberg H: Krebs and his trinity of cycles. *Nat Rev Mol Cell Biol* 2000;1:225.
- Ott P, Clemmesen O, Larsen FS: Cerebral metabolic disturbances in the brain during acute liver failure: from hyperammonemia to energy failure and proteolysis. *Neurochem Int* 2005;47:13.
- Owen OE, Kalhan SC: The key role of anaplerosis and cataplerosis for citric acid cycle function. *J Biol Chem* 2002;277:30409.
- Pithukpakorn M: Disorders of pyruvate metabolism and the tricarboxylic acid cycle. *Mol Genet Metab* 2005;85:243.
- Proudfoot AT, Bradberry SM: Sodium fluoroacetate poisoning. *Toxicol Rev* 2006;25:2139.
- Rama Rao KV, Norenberg MD: Brain energy metabolism and mitochondrial dysfunction in acute and chronic hepatic encephalopathy. *Neurochem Int* 2012;60:697.
- Sumegi B, Sherry AD: Is there tight channelling in the tricarboxylic acid cycle metabolon? *Biochem Soc Trans* 1991;19:1002.

Glycolysis & the Oxidation of Pyruvate

David A. Bender, PhD & Peter A. Mayes, PhD, DSc

OBJECTIVES

After studying this chapter, you should be able to:

- Describe the pathway of glycolysis and its control, and explain how glycolysis can operate under anaerobic conditions.
- Describe the reaction of pyruvate dehydrogenase and its regulation.
- Explain how inhibition of pyruvate metabolism leads to lactic acidosis.

BIOMEDICAL IMPORTANCE

Most tissues have at least some requirement for glucose. In the brain, the requirement is substantial, and even in prolonged fasting the brain can meet no more than about 20% of its energy needs from ketone bodies. Glycolysis, the major pathway for glucose metabolism, occurs in the cytosol of all cells. It can function either aerobically or anaerobically, depending on the availability of oxygen and the electron transport chain. Erythrocytes, which lack mitochondria, are completely reliant on glucose as their metabolic fuel, and metabolize it by anaerobic glycolysis. However, to oxidize glucose beyond pyruvate (the end product of glycolysis) requires both oxygen and mitochondrial enzyme systems: the pyruvate dehydrogenase complex, the citric acid cycle (see Chapter 16), and the respiratory chain (see Chapter 13).

Glycolysis is the principal route for carbohydrate metabolism. The ability of glycolysis to provide ATP in the absence of oxygen is especially important, because this allows skeletal muscle to perform at very high levels of work output when oxygen supply is insufficient, and it allows tissues to survive anoxic episodes. However, heart muscle, which is adapted for aerobic performance, has relatively low glycolytic activity and poor survival under conditions of **ischemia**. Diseases in which enzymes of glycolysis (eg, pyruvate kinase) are deficient are mainly seen as **hemolytic anemias** or, if the defect affects skeletal muscle (eg, phosphofructokinase), as **fatigue**. In fast-growing cancer cells, glycolysis proceeds at a high rate, forming large amounts of pyruvate, which is reduced to lactate and exported. This produces a relatively acidic local environment in the tumor, which may have implications for cancer therapy. The lactate is used for

gluconeogenesis in the liver (Chapter 19), an energy-expensive process, which is responsible for much of the **hypermetabolism** seen in **cancer cachexia**. **Lactic acidosis** results from various causes, including impaired activity of pyruvate dehydrogenase, especially in thiamin (vitamin B₁) deficiency.

GLYCOLYSIS CAN FUNCTION UNDER ANAEROBIC CONDITIONS

Early in the investigations of glycolysis it was realized that fermentation in yeast was similar to the breakdown of glycogen in muscle. It was noted that when a muscle contracts in an anaerobic medium **glycogen disappears** and **lactate appears**. When oxygen is admitted, aerobic recovery takes place and lactate is no longer produced. However, if muscle contraction occurs under aerobic conditions, lactate does not accumulate and pyruvate is the major end product of glycolysis. Pyruvate is oxidized further to CO₂ and water (**Figure 17-1**). When oxygen is in short supply, mitochondrial reoxidation of NADH formed during glycolysis is impaired, and NADH is reoxidized by reducing pyruvate to lactate, so permitting glycolysis to continue. While glycolysis can occur under anaerobic conditions, this has a price, for it limits the amount of ATP formed per mole of glucose oxidized, so that much more glucose must be metabolized under anaerobic than aerobic conditions (Table 17-1). In yeast and some other microorganisms, pyruvate formed in anaerobic glycolysis is not reduced to lactate, but is decarboxylated and reduced to ethanol.

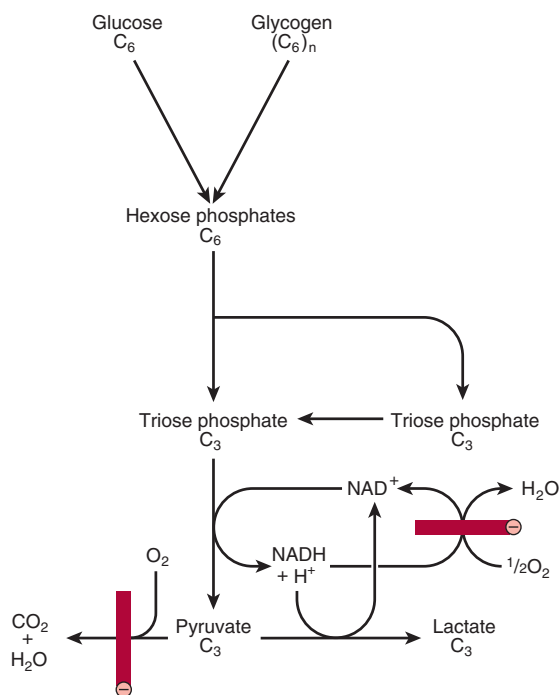
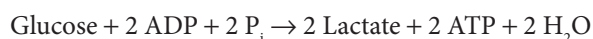

FIGURE 17-1 Summary of glycolysis. ⊖, blocked under anaerobic conditions or by absence of mitochondria containing key respiratory enzymes, as in erythrocytes.

THE REACTIONS OF GLYCOLYSIS CONSTITUTE THE MAIN PATHWAY OF GLUCOSE UTILIZATION

The overall equation for glycolysis from glucose to lactate is as follows:



All of the enzymes of glycolysis (**Figure 17-2**) are cytosolic. Glucose enters glycolysis by phosphorylation to glucose-6-phosphate, catalyzed by **hexokinase**, using ATP as the phosphate donor. Under physiological conditions, the phosphorylation of glucose to glucose-6-phosphate can be regarded as irreversible. Hexokinase is inhibited allosterically by its product, glucose-6-phosphate.

In tissues other than the liver (and pancreatic β -islet cells), the availability of glucose for glycolysis (or glycogen synthesis in muscle, Chapter 18, and lipogenesis in adipose tissue, Chapter 23) is controlled by transport into the cell, which in turn is regulated by **insulin**. Hexokinase has a high affinity (low K_m) for glucose, and in the liver it is saturated under

TABLE 17-1 ATP Formation in the Catabolism of Glucose

Pathway	Reaction Catalyzed by	Method of ATP Formation	ATP per mol of Glucose
Glycolysis	Glyceraldehyde-3-phosphate dehydrogenase	Respiratory chain oxidation of 2 NADH	5 ^a
	Phosphoglycerate kinase	Substrate-level phosphorylation	2
	Pyruvate kinase	Substrate-level phosphorylation	2
			9
	Consumption of ATP for reactions of hexokinase and phosphofructokinase		-2
			Net 7
Citric acid cycle	Pyruvate dehydrogenase	Respiratory chain oxidation of 2 NADH	5
	Isocitrate dehydrogenase	Respiratory chain oxidation of 2 NADH	5
	α -Ketoglutarate dehydrogenase	Respiratory chain oxidation of 2 NADH	5
	Succinate thiokinase	Substrate level phosphorylation	2
	Succinate dehydrogenase	Respiratory chain oxidation of 2 FADH ₂	3
	Malate dehydrogenase	Respiratory chain oxidation of 2 NADH	5
			Net 25
	Total per mol of glucose under aerobic conditions		32
	Total per mol of glucose under anaerobic conditions		2

^aThis assumes that NADH formed in glycolysis is transported into mitochondria by the malate shuttle (Figure 13-13). If the glycerophosphate shuttle is used, then only 1.5 ATP will be formed per mol of NADH. Note that there is a considerable advantage in using glycogen rather than glucose for anaerobic glycolysis in muscle, since the product of glycogen phosphorylase is glucose-1-phosphate (Figure 18-1), which is interconvertible with glucose-6-phosphate. This saves the ATP that would otherwise be used by hexokinase, increasing the net yield of ATP from 2 to 3 per glucose.

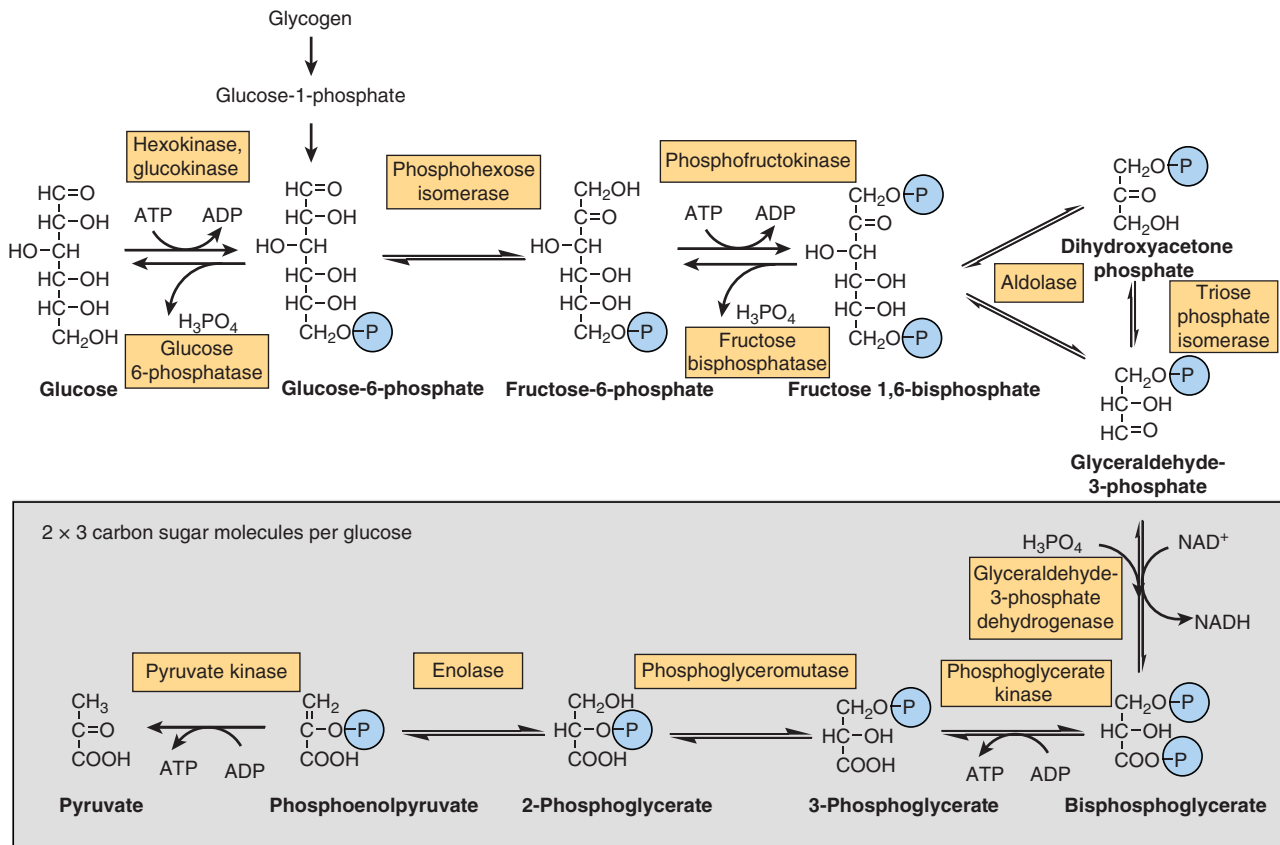

FIGURE 17-2 The pathway of glycolysis. (⊖, — PO_3^{2-} ; P_i , HOPO_3^{2-} ; ⊕, inhibition.) *Carbons 1-3 of fructose bisphosphate form dihydroxyacetone phosphate, and carbons 4-6 form glyceraldehyde-3-phosphate.

normal conditions, and so acts at a constant rate to provide glucose-6-phosphate to meet the liver's needs. Liver cells also contain an isoenzyme of hexokinase, **glucokinase**, which has a K_m very much higher than the normal intracellular concentration of glucose. The function of glucokinase in the liver is to remove glucose from the hepatic portal blood following a meal, so regulating the concentration of glucose available to peripheral tissues. This provides more glucose 6-phosphate than is required for glycolysis; it is used for glycogen synthesis and lipogenesis. Glucokinase is also found in pancreatic β -islet cells, where it functions to detect high concentrations of glucose. As more glucose is phosphorylated by glucokinase, there is increased glycolysis, leading to increased formation of ATP. This leads to closure of an ATP-potassium channel, causing membrane depolarization and opening of a voltage-gated calcium channel. The resultant influx of calcium ions leads to fusion of the insulin secretory granules with the cell membrane, and the release of insulin.

Glucose 6-phosphate is an important compound at the junction of several metabolic pathways: glycolysis, gluconeogenesis (see Chapter 19), the pentose phosphate pathway (see Chapter 20), glycogenesis, and glycogenolysis (see Chapter 18). In glycolysis, it is converted to fructose 6-phosphate by **phosphohexose isomerase**, which involves an aldose-ketose isomerization. This reaction is followed by another phosphorylation

catalyzed by the enzyme **phosphofructokinase** (phosphofructokinase-1) forming fructose 1,6-bisphosphate. The phosphofructokinase reaction is irreversible under physiological conditions. Phosphofructokinase is both inducible and subject to allosteric regulation, and has a major role in regulating the rate of glycolysis. Fructose 1,6-bisphosphate is cleaved by **aldolase** (fructose 1,6-bisphosphate aldolase) into two triose phosphates, glyceraldehyde-3-phosphate and dihydroxyacetone phosphate, which are interconverted by the enzyme **phosphotriose isomerase**.

Glycolysis continues with the oxidation of glyceraldehyde-3-phosphate to 1,3-bisphosphoglycerate. The enzyme catalyzing this oxidation, **glyceraldehyde-3-phosphate dehydrogenase**, is NAD dependent. Structurally, it consists of four identical polypeptides (monomers) forming a tetramer. Four —SH groups are present on each polypeptide, derived from cysteine residues within the polypeptide chain. One of the —SH groups is found at the active site of the enzyme (**Figure 17-3**). The substrate initially combines with this —SH group, forming a thiohemiacetal that is oxidized to a thiol ester; the hydrogens removed in this oxidation are transferred to NAD^+ . The thiol ester then undergoes phosphorolysis; inorganic phosphate (P_i) is added, forming 1,3-bisphosphoglycerate, and the free —SH group.

In the next reaction, catalyzed by **phosphoglycerate kinase**, phosphate is transferred from 1,3-bisphosphoglycerate

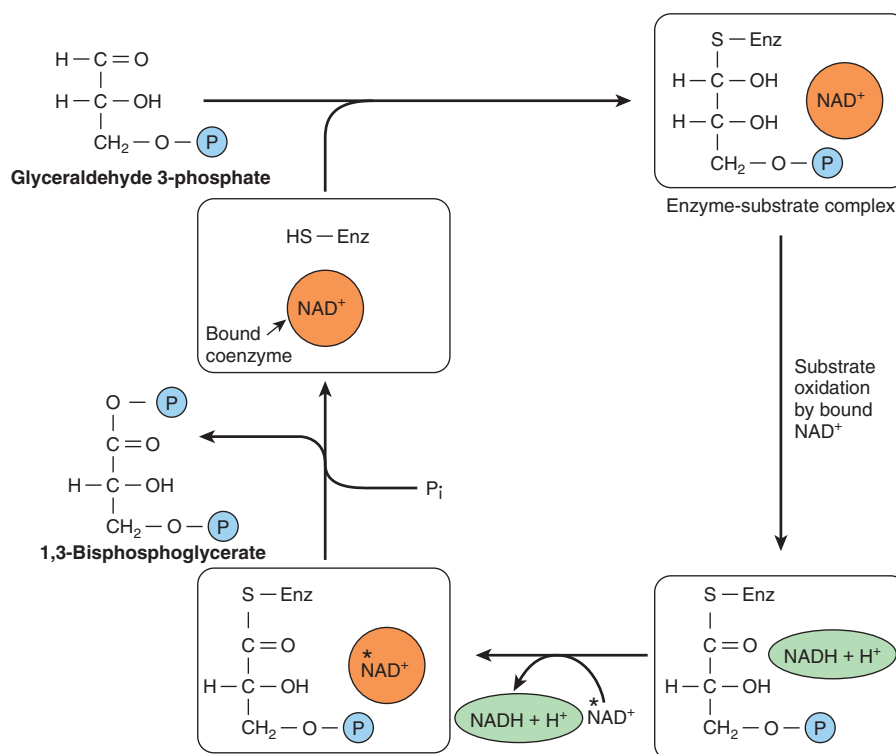

FIGURE 17-3 Mechanism of oxidation of glyceraldehyde 3-phosphate. (Enz, glyceraldehyde 3-phosphate dehydrogenase.) The enzyme is inhibited by the —SH poison iodoacetate, which is thus able to inhibit glycolysis. The NADH produced on the enzyme is not so firmly bound to the enzyme as is NAD^+ . Consequently, NADH is easily displaced by another molecule of NAD^+ .

onto ADP, forming ATP (substrate-level phosphorylation) and 3-phosphoglycerate. Since two molecules of triose phosphate are formed per molecule of glucose undergoing glycolysis, two molecules of ATP are formed in this reaction per molecule of glucose undergoing glycolysis. The toxicity of arsenic is the result of competition of arsenate with inorganic phosphate (P_i) in this reaction to give 1-arseno-3-phosphoglycerate, which undergoes spontaneous hydrolysis to 3-phosphoglycerate without forming ATP. 3-Phosphoglycerate is isomerized to 2-phosphoglycerate by **phosphoglycerate mutase**. It is likely that 2,3-bisphosphoglycerate (diphosphoglycerate, DPG) is an intermediate in this reaction.

The subsequent step is catalyzed by **enolase** and involves a dehydration, forming phosphoenolpyruvate. Enolase is inhibited by **fluoride**, and when blood samples are taken for measurement of glucose, glycolysis is inhibited by taking the sample into tubes containing fluoride. Enolase is also dependent on the presence of either Mg^{2+} or Mn^{2+} ions. The phosphate of phosphoenolpyruvate is transferred to ADP in another substrate-level phosphorylation catalyzed by **pyruvate kinase** to form two molecules of ATP per molecule of glucose oxidized. The reaction of pyruvate kinase is essentially irreversible under physiological conditions, partly because of the large free energy change involved and partly because the immediate product of the enzyme-catalyzed reaction is enol-pyruvate, which undergoes spontaneous

isomerization to pyruvate, so that the product of the reaction is not available to undergo the reverse reaction.

The availability of oxygen now determines which of the two pathways is followed. Under **anaerobic conditions**, the NADH cannot be reoxidized through the respiratory chain, and pyruvate is reduced to lactate catalyzed by **lactate dehydrogenase**. This permits the oxidation of NADH, permitting another molecule of glucose to undergo glycolysis. Under **aerobic conditions**, pyruvate is transported into mitochondria and undergoes oxidative decarboxylation to acetyl-CoA then oxidation to CO_2 in the citric acid cycle (see Chapter 16). The reducing equivalents from the NADH formed in glycolysis are taken up into mitochondria for oxidation via either the malate-aspartate shuttle or the glycerophosphate shuttle (see Chapter 13).

TISSUES THAT FUNCTION UNDER HYPOXIC CONDITIONS PRODUCE LACTATE

This is true of skeletal muscle, particularly the white fibers, where the rate of work output, and hence the need for ATP formation, may exceed the rate at which oxygen can be taken up and utilized. Glycolysis in erythrocytes always terminates in lactate, because the subsequent reactions of pyruvate oxidation are mitochondrial, and erythrocytes lack mitochondria.

Other tissues that normally derive much of their energy from glycolysis and produce lactate include brain, gastrointestinal tract, renal medulla, retina, and skin. Lactate production is also increased in septic shock, and many cancers also produce lactate. The liver, kidneys, and heart normally take up lactate and oxidize it, but produce it under hypoxic conditions.

When lactate production is high, as in vigorous exercise, septic shock, and cancer cachexia, much is used in the liver for gluconeogenesis (see Chapter 19), leading to an increase in metabolic rate to provide the ATP and GTP needed. The increase in oxygen consumption as a result of increased oxidation of metabolic fuels to provide the ATP and GTP needed for gluconeogenesis is seen as **oxygen debt** after vigorous exercise.

Under some conditions, lactate may be formed in the cytosol, but then enter the mitochondrion to be oxidized to pyruvate for onward metabolism. This provides a pathway for the transfer of reducing equivalents from the cytosol into the mitochondrion for the electron transport chain in addition to the glycerophosphate (see Figure 13–12) and malate-aspartate (see Figure 13–13) shuttles.

GLYCOLYSIS IS REGULATED AT THREE STEPS INVOLVING NONEQUILIBRIUM REACTIONS

Although most of the reactions of glycolysis are freely reversible, three are markedly exergonic and must therefore be considered to be physiologically irreversible. These reactions, catalyzed by **hexokinase** (and glucokinase), **phosphofruktokinase**, and **pyruvate kinase**, are the major sites of regulation of glycolysis. Phosphofruktokinase is significantly inhibited at normal intracellular concentrations of ATP; as discussed in Chapter 19, this inhibition can be rapidly relieved by 5'AMP that is formed as ADP begins to accumulate, signaling the need for an increased rate of glycolysis. Cells that are capable of **gluconeogenesis** (reversing the glycolytic pathway, Chapter 19) have different enzymes that catalyze reactions to reverse these irreversible steps; glucose 6-phosphatase, fructose 1,6-bisphosphatase and, to reverse the reaction of pyruvate kinase, pyruvate carboxylase and phosphoenolpyruvate carboxykinase. The reciprocal regulation of phosphofruktokinase in glycolysis and fructose 1,6-bisphosphatase in gluconeogenesis is discussed in Chapter 19.

Fructose enters glycolysis by phosphorylation to fructose 1-phosphate, and bypasses the main regulatory steps, so resulting in formation of more pyruvate and acetyl-CoA than is required for ATP formation. In the liver and adipose tissue, this leads to increased lipogenesis, and a high intake of fructose may be a factor in the development of obesity.

In Erythrocytes, the First Site of ATP Formation in Glycolysis May Be Bypassed

In erythrocytes, the reaction catalyzed by **phosphoglycerate kinase** may be bypassed to some extent by the reaction of **bisphosphoglycerate mutase**, which catalyzes the conversion

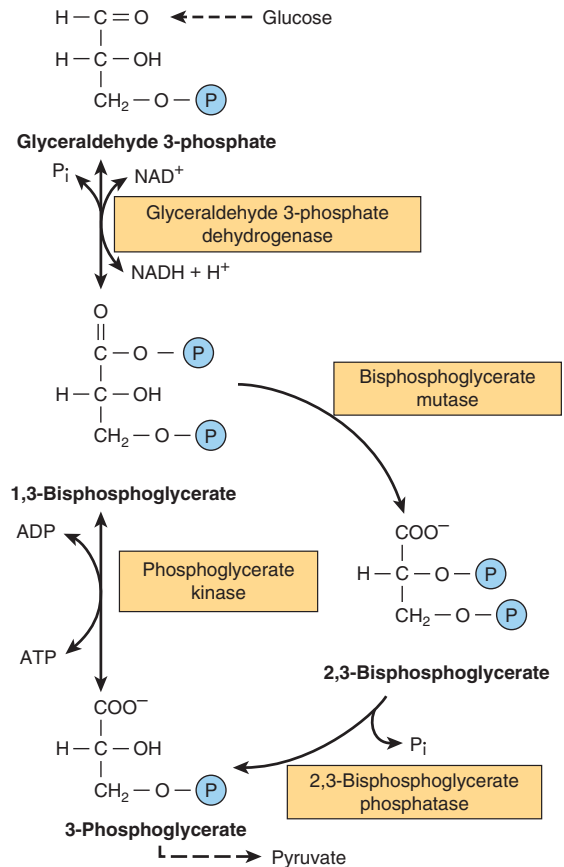

FIGURE 17–4 The 2,3-Bisphosphoglycerate pathway in erythrocytes.

of 1,3-bisphosphoglycerate to 2,3-bisphosphoglycerate, followed by hydrolysis to 3-phosphoglycerate and P_i , catalyzed by **2,3-bisphosphoglycerate phosphatase** (Figure 17–4). This pathway involves no net yield of ATP from glycolysis, but provides 2,3-bisphosphoglycerate, which binds to hemoglobin, decreasing its affinity for oxygen, so making oxygen more readily available to tissues (see Chapter 6).

THE OXIDATION OF PYRUVATE TO ACETYL-CoA IS THE IRREVERSIBLE ROUTE FROM GLYCOLYSIS TO THE CITRIC ACID CYCLE

Pyruvate, formed in the cytosol, is transported into the mitochondrion by a proton symporter. Inside the mitochondrion, it is oxidatively decarboxylated to acetyl-CoA by a multienzyme complex that is associated with the inner mitochondrial membrane. This **pyruvate dehydrogenase complex** is analogous to the α -ketoglutarate dehydrogenase complex of the citric acid cycle (see Chapter 16). Pyruvate is decarboxylated by the **pyruvate dehydrogenase** component of the enzyme complex to a hydroxyethyl derivative of the thiazole ring of enzyme-bound **thiamin diphosphate**, which in turn reacts with oxidized lipoamide, the prosthetic group of **dihydrolipoyl transacetylase**, to form acetyl

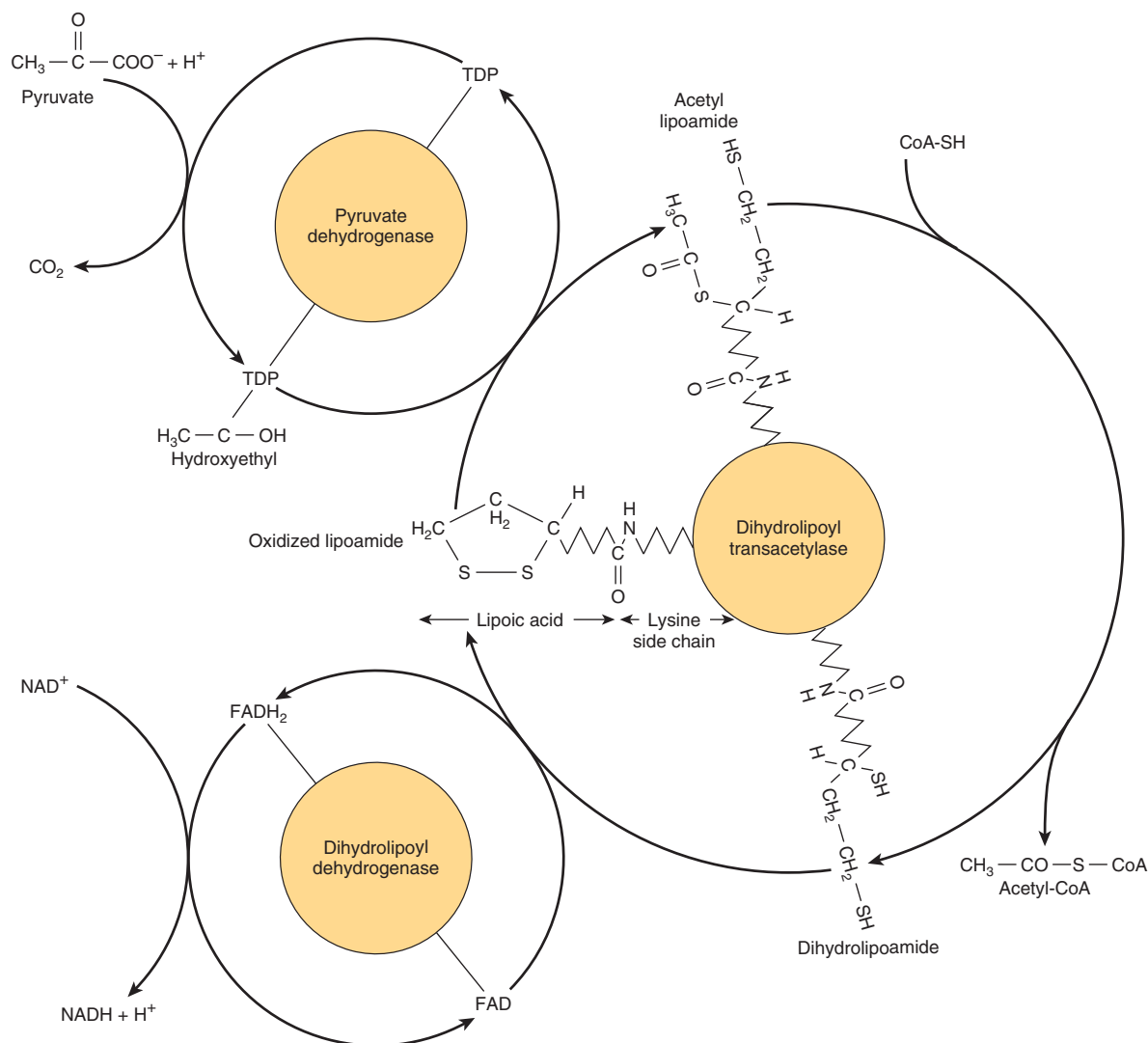

FIGURE 17-5 Oxidative decarboxylation of pyruvate by the pyruvate dehydrogenase complex. Lipoic acid is joined by an amide link to a lysine residue of the transacetylase component of the enzyme complex. It forms a long flexible arm, allowing the lipoic acid prosthetic group to rotate sequentially between the active sites of each of the enzymes of the complex. (FAD, flavin adenine dinucleotide; NAD^+ , nicotinamide adenine dinucleotide; TDP, thiamin diphosphate.)

lipoamide (Figure 17-5). Thiamin is vitamin B_1 (see Chapter 44) and in deficiency, glucose metabolism is impaired, and there is significant (and potentially life-threatening) lactic and pyruvic acidosis. Acetyl lipoamide reacts with coenzyme A to form acetyl-CoA and reduced lipoamide. The reaction is completed when the reduced lipoamide is reoxidized by a flavoprotein, **dihydrolipoyl dehydrogenase**, containing FAD. Finally, the reduced flavoprotein is oxidized by NAD^+ , which in turn transfers reducing equivalents to the respiratory chain. The overall reaction is:



The pyruvate dehydrogenase complex consists of a number of polypeptide chains of each of the three component enzymes, and the intermediates do not dissociate, but are channeled from one enzyme site to the next. This increases the rate of reaction and prevents side reactions, increasing overall efficiency.

Pyruvate Dehydrogenase Is Regulated by End-Product Inhibition & Covalent Modification

Pyruvate dehydrogenase is inhibited by its products, acetyl-CoA, and NADH (Figure 17-6). It is also regulated by phosphorylation (catalyzed by a kinase) of three serine residues on the pyruvate dehydrogenase component of the multienzyme complex, resulting in decreased activity and by dephosphorylation (catalyzed by a phosphatase) that causes an increase in activity. The kinase is activated by increases in the $[\text{ATP}]/[\text{ADP}]$, $[\text{acetyl-CoA}]/[\text{CoA}]$, and $[\text{NADH}]/[\text{NAD}^+]$ ratios. Thus, pyruvate dehydrogenase, and therefore glycolysis, is inhibited both when there is adequate ATP (and reduced coenzymes for ATP formation) available, and also when fatty acids are being oxidized. In fasting, when nonesterified fatty acid

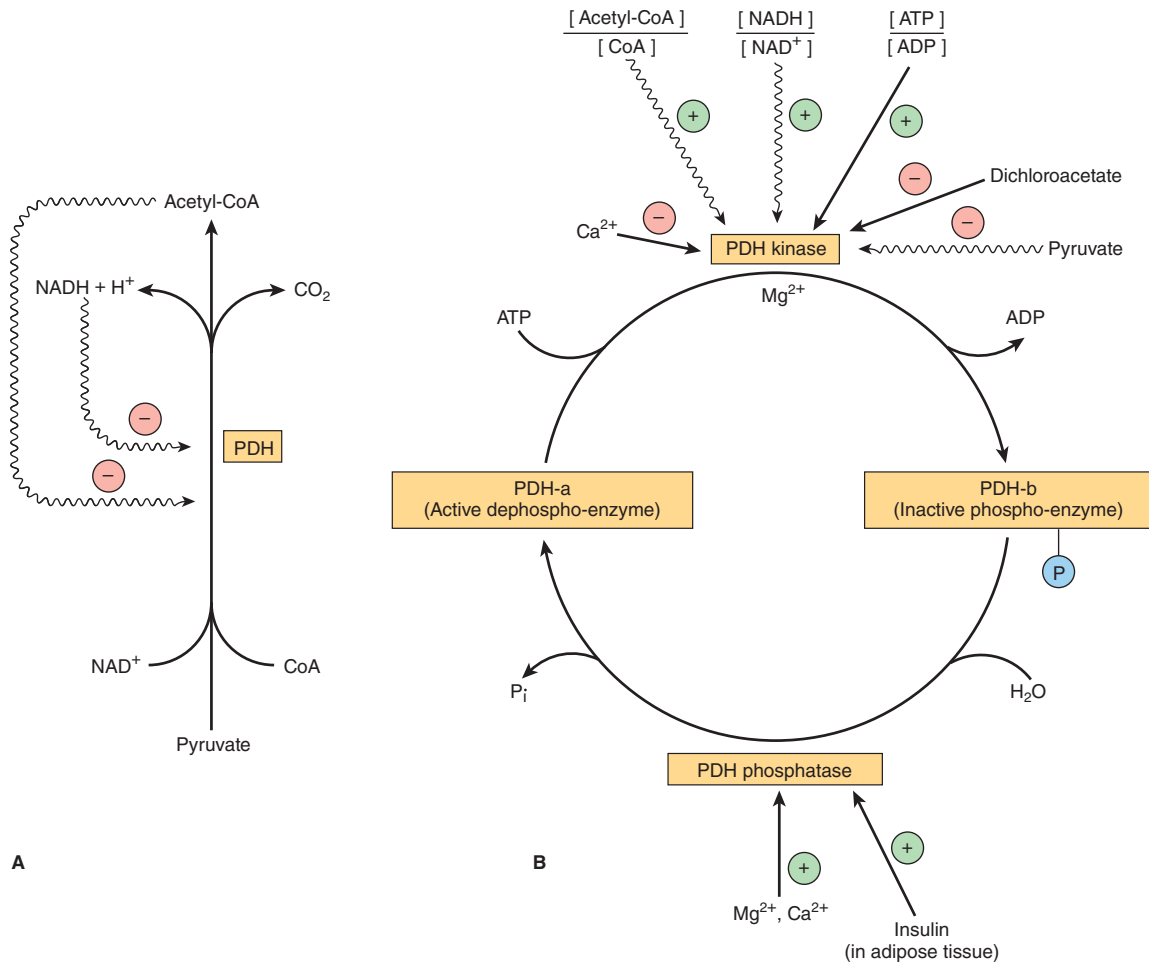

FIGURE 17-6 Regulation of pyruvate dehydrogenase (PDH). Arrows with wavy shafts indicate allosteric effects. **(A)** Regulation by end-product inhibition. **(B)** Regulation by interconversion of active and inactive forms.

concentrations increase, there is a decrease in the proportion of the enzyme in the active form, leading to a sparing of carbohydrate. In adipose tissue, where glucose provides acetyl-CoA for lipogenesis, the enzyme is activated in response to insulin.

CLINICAL ASPECTS

Inhibition of Pyruvate Metabolism Leads to Lactic Acidosis

Arsenite and mercuric ions react with the —SH groups of lipoic acid and inhibit pyruvate dehydrogenase, as does a **dietary deficiency of thiamin** (see Chapter 44), allowing pyruvate to accumulate. Many alcoholics are thiamin deficient (both because of a poor diet and also because alcohol inhibits thiamin absorption), and may develop potentially fatal pyruvic and lactic acidosis. Patients with **inherited pyruvate dehydrogenase deficiency**, which can be the result of defects in one or more of the components of the enzyme complex, also present with lactic acidosis, particularly after a glucose load. Because of

the dependence of the brain on glucose as a fuel, these metabolic defects commonly cause neurological disturbances.

Inherited aldolase A deficiency and pyruvate kinase deficiency in erythrocytes cause **hemolytic anemia**. The exercise capacity of patients with **muscle phosphofructokinase deficiency** is low, particularly if they are on high-carbohydrate diets. By providing lipid as an alternative fuel, for example, during starvation, when blood free fatty acid and ketone bodies are increased, work capacity is improved.

SUMMARY

- Glycolysis is the cytosolic pathway of all mammalian cells for the metabolism of glucose (or glycogen) to pyruvate and lactate.
- It can function anaerobically by regenerating oxidized NAD⁺ (required in the glyceraldehyde-3-phosphate dehydrogenase reaction), by reducing pyruvate to lactate.
- Lactate is the end product of glycolysis under anaerobic conditions (eg, in exercising muscle) and in erythrocytes, where there are no mitochondria to permit further oxidation of pyruvate.

- Glycolysis is regulated by three enzymes catalyzing nonequilibrium reactions: hexokinase, phosphofructokinase, and pyruvate kinase.
- In erythrocytes, the first site in glycolysis for generation of ATP may be bypassed, leading to the formation of 2,3-bisphosphoglycerate, which is important in decreasing the affinity of hemoglobin for O₂.
- Pyruvate is oxidized to acetyl-CoA by a multienzyme complex, pyruvate dehydrogenase, which is dependent on the vitamin-derived cofactor thiamin diphosphate.
- Conditions that involve an impairment of pyruvate metabolism frequently lead to lactic acidosis.

REFERENCES

- Behal RH, Buxton DB, Robertson JG, Olson MS: Regulation of the pyruvate dehydrogenase multienzyme complex. *Annu Rev Nutr* 1993;13:497.
- Boiteux A, Hess B: Design of glycolysis. *Philos Trans R Soc Lond B Biol Sci* 1981;293:5.
- Cairns SP: Lactic acid and exercise performance: culprit or friend? *Sports Med* 2006;36:279.
- Fall PJ, Szerlip HM: Lactic acidosis: from sour milk to septic shock. *J Intensive Care Med* 2005;20:255.
- Fothergill-Gilmore LA: The evolution of the glycolytic pathway. *Trends Biochem Sci* 1986;11:47.
- Gladden LB: Lactate metabolism: a new paradigm for the third millennium. *J Physiol* 2004;558:5.
- Gladden LB: A lactatic perspective on metabolism. *Med Sci Sports Exerc* 2008;40:477.
- Kim J-W, Dang CV: Multifaceted roles of glycolytic enzymes. *Trends Biochem Sci* 2005;30:142.
- Lalau JD: Lactic acidosis induced by metformin: incidence, management and prevention. *Drug Saf* 2010;33:727.
- Levy B: Lactate and shock state: the metabolic view. *Curr Opin Crit Care* 2006;1:315.
- Maj MC, Cameron JM, Robinson BH: Pyruvate dehydrogenase phosphatase deficiency: orphan disease or an under-diagnosed condition? *Mol Cell Endocrinol* 2006;249:1.
- Martin E, Rosenthal RE, Fiskum G: Pyruvate dehydrogenase complex: metabolic link to ischemic brain injury and target of oxidative stress. *J Neurosci Res* 2005;79:240.
- Patel KP, O'Brien TW: The spectrum of pyruvate dehydrogenase complex deficiency: clinical, biochemical and genetic features in 371 patients. *Mol Genet Metab* 2012;105:34.
- Patel MS, Korotchkina LG: Regulation of the pyruvate dehydrogenase complex. *Biochem Soc Trans* 2006;34:217.
- Philp A, Macdonald AL, Watt PW: Lactate—a signal coordinating cell and systemic function. *J Exp Biol* 2005;208:4561.
- Rider MH, Bertrand L, Vertommen D, et al: 6-Phosphofructo-2-kinase/fructose-2,6-bisphosphatase: head-to-head with a bifunctional enzyme that controls glycolysis. *Biochem J* 2004;381:561.
- Robergs RA, Ghiasvand F, Parker D: Biochemistry of exercise-induced metabolic acidosis. *Am J Physiol* 2004;287:R502.
- Sugden MC, Holness MJ: Mechanisms underlying regulation of the expression and activities of the mammalian pyruvate dehydrogenase kinases. *Arch Physiol Biochem* 2006;112:139.
- Wasserman DH: Regulation of glucose fluxes during exercise in the postabsorptive state. *Annu Rev Physiol* 1995;57:191.

Metabolism of Glycogen

David A. Bender, PhD & Peter A. Mayes, PhD, DSc

OBJECTIVES

After studying this chapter, you should be able to:

- Describe the structure of glycogen and its importance as a carbohydrate reserve.
- Describe the synthesis and breakdown of glycogen and how the processes are regulated in response to hormone action.
- Describe the various types of glycogen storage diseases.

BIOMEDICAL IMPORTANCE

Glycogen is the major storage carbohydrate in animals, corresponding to starch in plants; it is a branched polymer of α -D-glucose (see Figure 15–12). It occurs mainly in liver and muscle, with modest amounts in the brain. Although the liver content of glycogen is greater than that of muscle, because the muscle mass of the body is considerably greater than that of the liver, about three-quarters of total body glycogen is in muscle (Table 18–1).

Muscle glycogen provides a readily available source of glucose-1-phosphate for glycolysis within the muscle itself. Liver glycogen functions as a reserve to maintain the **blood glucose** concentration in the fasting state. The liver concentration of glycogen is about 450 mmol /L glucose equivalents after a meal, falling to about 200 mmol /L after an overnight fast; after 12 to 18 hours of fasting, liver glycogen is almost totally depleted. Although muscle glycogen does not directly yield free glucose (because muscle lacks glucose-6-phosphatase), pyruvate formed by glycolysis in muscle can undergo transamination to alanine, which is exported from muscle and used for gluconeogenesis in the liver (see Figure 19–4). **Glycogen storage diseases** are a group of inherited disorders characterized by deficient mobilization of glycogen or deposition of abnormal forms of glycogen, leading to liver damage and muscle weakness; some glycogen storage diseases result in early death.

The highly branched structure of glycogen (see Figure 15–12) provides a large number of sites for glycogenolysis, permitting rapid release of glucose-1-phosphate for muscle activity. Endurance athletes require a slower, more sustained release

of glucose-1-phosphate. The formation of branch points in glycogen is slower than the addition of glucose units to a linear chain, and some endurance athletes practice **carbohydrate loading**—exercise to exhaustion (when muscle glycogen is largely depleted) followed by a high-carbohydrate meal, which results in rapid glycogen synthesis, with fewer branch points than normal.

GLYCOGENESIS OCCURS MAINLY IN MUSCLE & LIVER

Glycogen Biosynthesis Involves UDP-Glucose

As in glycolysis, glucose is phosphorylated to glucose-6-phosphate, catalyzed by **hexokinase** in muscle and **glucokinase** in liver (Figure 18–1). Glucose-6-phosphate is isomerized to glucose-1-phosphate by **phosphoglucomutase**. The enzyme itself is phosphorylated, and the phosphate group takes part in a reversible reaction in which glucose 1,6-bisphosphate is an intermediate. Next, glucose-1-phosphate reacts with uridine triphosphate (UTP) to form the active nucleotide **uridine diphosphate glucose (UDPGlc)** and pyrophosphate (Figure 18–2), catalyzed by **UDPGlc pyrophosphorylase**. The reaction proceeds in the direction of UDPGlc formation because **pyrophosphatase** catalyzes hydrolysis of pyrophosphate to $2 \times$ phosphate, so removing one of the reaction products. UDPGlc pyrophosphorylase has a low K_m for glucose-1-phosphate and is present in relatively large amounts, so that it is not a regulatory step in glycogen synthesis.

TABLE 18-1 Storage of Carbohydrate in a 70-kg Human Being

	Percentage of Tissue Weight	Tissue Weight	Body Content (g)
Liver glycogen	5.0	1.8 kg	90
Muscle glycogen	0.7	35 kg	245
Extracellular glucose	0.1	10 L	10

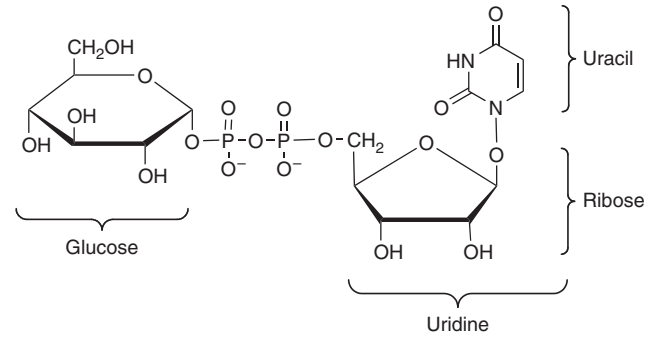

FIGURE 18-2 Uridine diphosphate glucose (UDPGlc).

The initial steps in glycogen synthesis involve the protein **glycogenin**, a 37-kDa protein that is glucosylated on a specific tyrosine residue by UDPGlc. Glycogenin catalyzes the transfer of a further seven glucose residues from UDPGlc, in 1 → 4 linkage, to form a **glycogen primer** that is the substrate for glycogen synthase. The glycogenin remains at the core of the glycogen granule (see Figure 15-12). **Glycogen synthase**

catalyzes the formation of a glycoside bond between C-1 of the glucose of UDPGlc and C-4 of a terminal glucose residue of glycogen, liberating uridine diphosphate (UDP). The addition of a glucose residue to a preexisting glycogen chain, or “primer,”

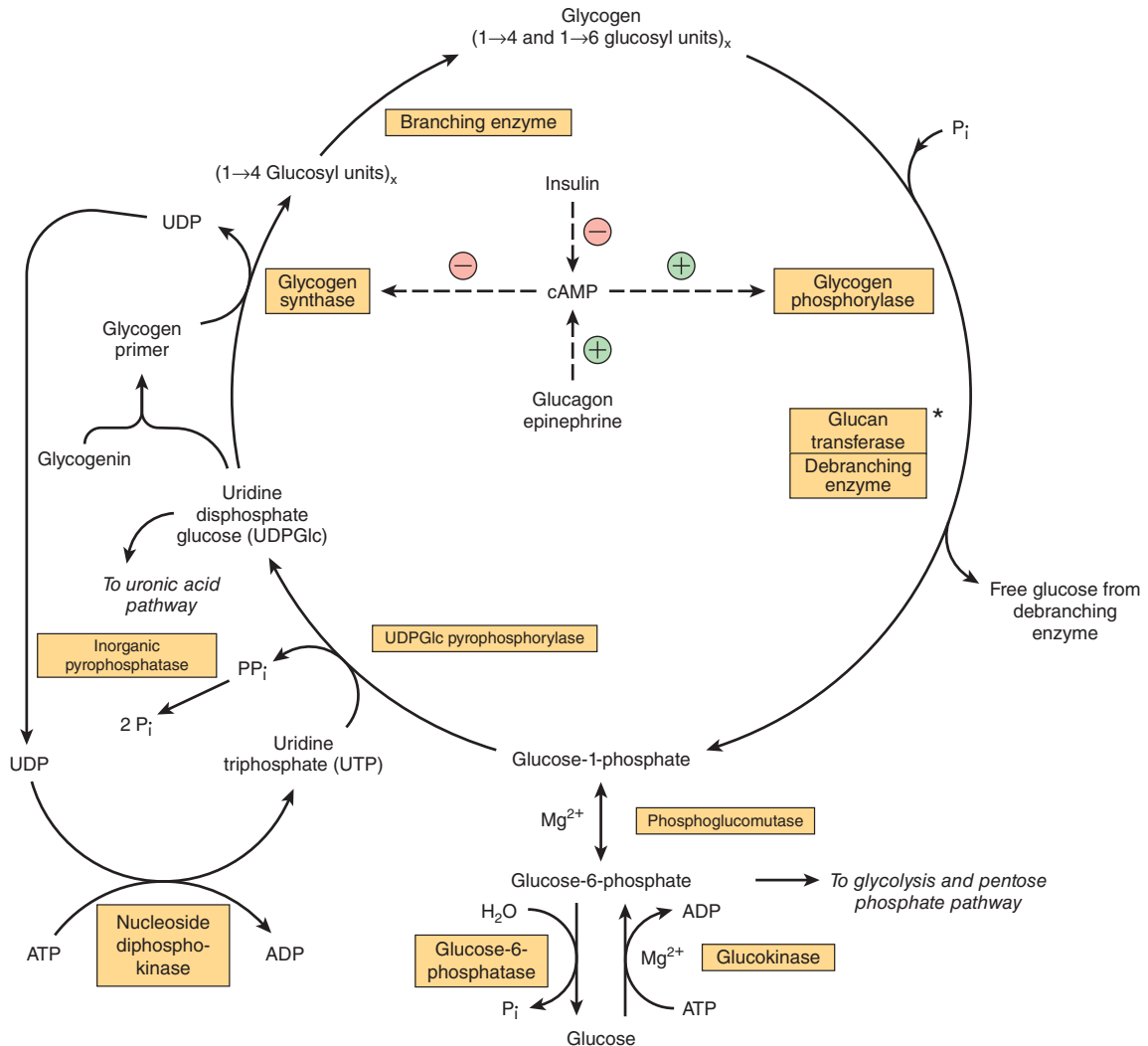

FIGURE 18-1 Pathways of glycogenesis and glycogenolysis in the liver. (⊕, Stimulation; ⊖, inhibition.) Insulin decreases the level of cAMP and has been raised by glucagon or epinephrine; that is, it antagonizes their action. Glucagon is active in heart muscle but not in skeletal muscle. *Glucan transferase and debranching enzyme appear to be two separate activities of the same enzyme.

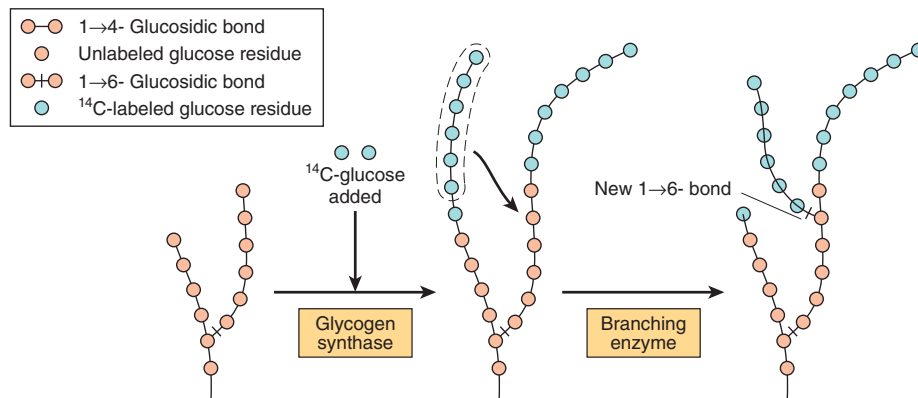

FIGURE 18-3 The biosynthesis of glycogen. The mechanism of branching as revealed by feeding ^{14}C -labeled glucose and examining liver glycogen at intervals.

occurs at the nonreducing, outer end of the molecule, so that the branches of the glycogen molecule become elongated as successive $1 \rightarrow 4$ linkages are formed (Figure 18-3).

Branching Involves Detachment of Existing Glycogen Chains

When a growing chain is at least 11 glucose residues long, **branching enzyme** transfers a part of the $1 \rightarrow 4$ -chain (at least six glucose residues) to a neighboring chain to form a $1 \rightarrow 6$ linkage, establishing a **branch point**. The branches grow by further additions of $1 \rightarrow 4$ -glucosyl units and further branching.

GLYCOGENOLYSIS IS NOT THE REVERSE OF GLYCOGENESIS, BUT IS A SEPARATE PATHWAY

Glycogen phosphorylase catalyzes the rate-limiting step in glycogenolysis—the phosphorylytic cleavage (phosphorolysis; cf hydrolysis) of the $1 \rightarrow 4$ linkages of glycogen to yield glucose 1-phosphate (Figure 18-4). There are different isoenzymes of glycogen phosphorylase in liver, muscle, and brain, encoded by different genes. Glycogen phosphorylase requires pyridoxal phosphate (see Chapter 44) as its coenzyme. Unlike the reactions of amino acid metabolism (see Chapter 28), in which the aldehyde group of the coenzyme is the reactive group, in phosphorylase it is the phosphate group that is catalytically active.

The terminal glucosyl residues from the outermost chains of the glycogen molecule are removed sequentially until approximately four glucose residues remain on either side of a $1 \rightarrow 6$ branch (Figure 18-4). The **debranching enzyme** has two catalytic sites in a single polypeptide chain. One is a **glucan transferase** that transfers a trisaccharide unit from one branch to the other, exposing the $1 \rightarrow 6$ branch point. The other is a **1,6-glycosidase** that catalyzes hydrolysis of the $1 \rightarrow 6$ glycoside bond to liberate free glucose. Further phosphorylase action can

then proceed. The combined action of phosphorylase and these other enzymes leads to the complete breakdown of glycogen.

The reaction catalyzed by phosphoglucomutase is reversible, so that glucose-6-phosphate can be formed from glucose 1-phosphate. In **liver**, but not muscle, **glucose-6-phosphatase** catalyzes hydrolysis of glucose-6-phosphate, yielding glucose that is exported, leading to an increase in the blood glucose concentration. Glucose-6-phosphatase is in the lumen of the smooth endoplasmic reticulum, and genetic defects of the glucose-6-phosphate transporter can cause a variant of type I glycogen storage disease (Table 18-2).

Glycogen granules can also be engulfed by **lysosomes**, where acid maltase catalyzes the hydrolysis of glycogen to glucose. This may be especially important in glucose homeostasis in neonates. Genetic lack of lysosomal acid maltase causes type II glycogen storage disease (Pompe disease, Table 18-2). The lysosomal catabolism of glycogen is under hormonal control.

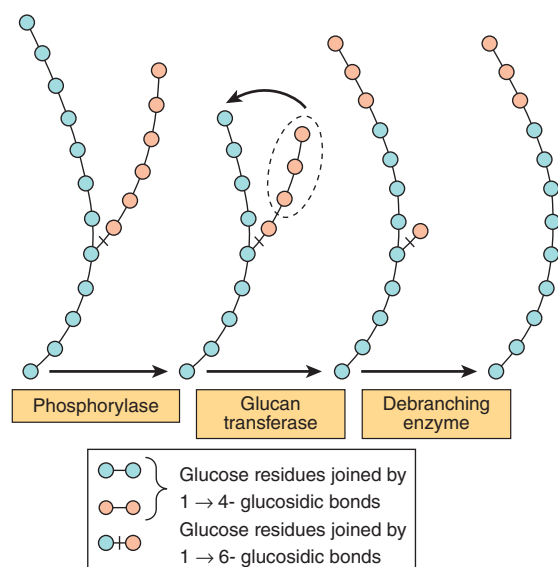

FIGURE 18-4 Steps in glycogenolysis.

TABLE 18-2 Glycogen Storage Diseases

Type	Name	Enzyme Deficiency	Clinical Features
0	—	Glycogen synthase	Hypoglycemia; hyperketonemia; early death
Ia	Von Gierke disease	Glucose-6-phosphatase	Glycogen accumulation in liver and renal tubule cells; hypoglycemia; lactic acidemia; ketosis; hyperlipemia
Ib	—	Endoplasmic reticulum glucose-6-phosphate transporter	As type Ia; neutropenia and impaired neutrophil function leading to recurrent infections
II	Pompe disease	Lysosomal $\alpha_1 \rightarrow 4$ and $\alpha_1 \rightarrow 6$ glucosidase (acid maltase)	Accumulation of glycogen in lysosomes: juvenile onset variant, muscle hypotonia, death from heart failure by age 2; adult onset variant, muscle dystrophy
IIIa	Limit dextrinosis, Forbe or Cori disease	Liver and muscle debranching enzyme	Fasting hypoglycemia; hepatomegaly in infancy; accumulation of characteristic branched polysaccharide (limit dextrin); muscle weakness
IIIb	Limit dextrinosis	Liver debranching enzyme	As type IIIa, but no muscle weakness
IV	Amylopectinosis, Andersen disease	Branching enzyme	Hepatosplenomegaly; accumulation of polysaccharide with few branch points; death from heart or liver failure before age 5
V	Myophosphorylase deficiency, McArdle syndrome	Muscle phosphorylase	Poor exercise tolerance; muscle glycogen abnormally high (2.5%-4%); blood lactate very low after exercise
VI	Hers disease	Liver phosphorylase	Hepatomegaly; accumulation of glycogen in liver; mild hypoglycemia; generally good prognosis
VII	Tarui disease	Muscle and erythrocyte phosphofructokinase 1	Poor exercise tolerance; muscle glycogen abnormally high (2.5%-4%); blood lactate very low after exercise; also hemolytic anemia
VIII		Liver phosphorylase kinase	Hepatomegaly; accumulation of glycogen in liver; mild hypoglycemia; generally good prognosis
IX		Liver and muscle phosphorylase kinase	Hepatomegaly; accumulation of glycogen in liver and muscle; mild hypoglycemia; generally good prognosis
X		cAMP-dependent protein kinase A	Hepatomegaly; accumulation of glycogen in liver

CYCLIC AMP INTEGRATES THE REGULATION OF GLYCOGENOLYSIS & GLYCOGENESIS

The principal enzymes controlling glycogen metabolism—glycogen phosphorylase and glycogen synthase—are regulated in opposite directions by allosteric mechanisms and covalent modification by reversible phosphorylation and dephosphorylation of enzyme protein in response to hormone action (see Chapter 9). Phosphorylation of glycogen phosphorylase increases its activity; phosphorylation of glycogen synthase reduces its activity.

Phosphorylation is increased in response to cyclic AMP (cAMP) (Figure 18-5) formed from ATP by **adenylyl cyclase** at the inner surface of cell membranes in response to hormones such as **epinephrine**, **norepinephrine**, and **glucagon**. cAMP is hydrolyzed by **phosphodiesterase**, so terminating hormone action; in liver insulin increases the activity of phosphodiesterase.

Glycogen Phosphorylase Regulation Is Different in Liver & Muscle

In the liver, the role of glycogen is to provide free glucose for export to maintain the blood concentration of glucose; in muscle the role of glycogen is to provide a source of glucose-6-phosphate for glycolysis in response to the need for ATP for muscle contraction. In both tissues, the enzyme is activated by phosphorylation catalyzed by phosphorylase kinase (to yield phosphorylase a) and inactivated by dephosphorylation catalyzed by phosphoprotein phosphatase (to yield phosphorylase b), in response to hormonal and other signals.

There is instantaneous overriding of this hormonal control. Active phosphorylase a in both tissues is allosterically inhibited by ATP and glucose-6-phosphate; in liver, but not muscle, free glucose is also an inhibitor. Muscle phosphorylase differs from the liver isoenzyme in having a binding site for 5' AMP (Figure 18-5), which acts as an allosteric activator of the (inactive) dephosphorylated b-form of the enzyme. 5' AMP acts as a potent signal of the energy state of the muscle cell; it is formed as the concentration of ADP begins to increase (indicating the need for increased substrate metabolism to permit

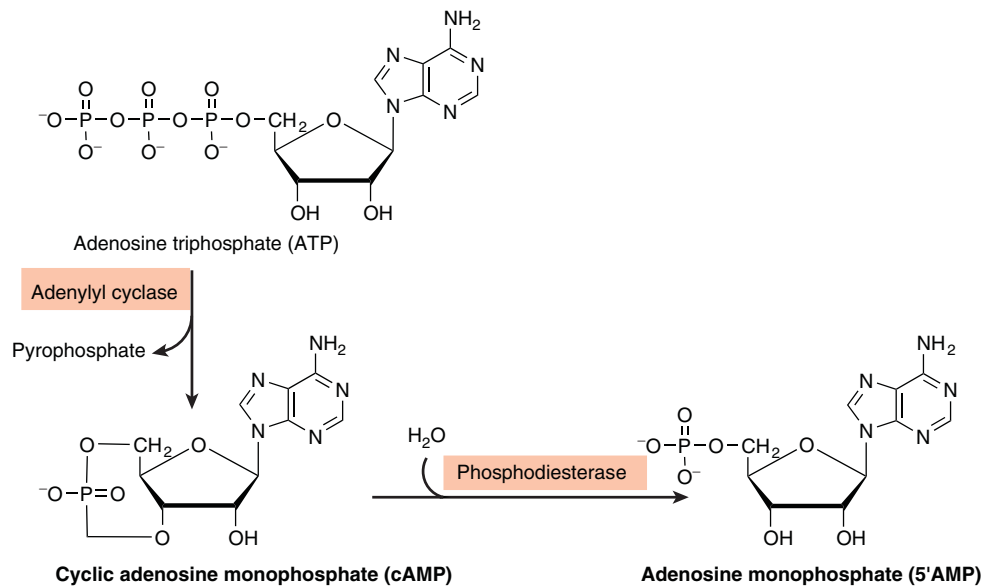

FIGURE 18-5 The formation and hydrolysis of cyclic AMP (3',5'-adenylic acid, cAMP).

ATP formation), as a result of the reaction of adenylate kinase:
 $2 \times \text{ADP} \leftrightarrow \text{ATP} + 5' \text{ AMP}$

cAMP ACTIVATES GLYCOGEN PHOSPHORYLASE

Phosphorylase kinase is activated in response to cAMP (Figure 18-6). Increasing the concentration of cAMP activates **cAMP-dependent protein kinase**, which catalyzes the phosphorylation by ATP of inactive **phosphorylase kinase b** to active **phosphorylase kinase a**, which in turn, phosphorylates phosphorylase b to phosphorylase a. In the liver, cAMP is formed in response to glucagon, which is secreted in response to falling blood glucose. Muscle is insensitive to glucagon; in muscle, the signal for increased cAMP formation is the action of norepinephrine, which is secreted in response to fear or fright, when there is a need for increased glycogenolysis to permit rapid muscle activity.

Ca²⁺ Synchronizes the Activation of Glycogen Phosphorylase With Muscle Contraction

Glycogenolysis in muscle increases several hundred-fold at the onset of contraction; the same signal (increased cytosolic Ca²⁺ ion concentration) is responsible for initiation of both contraction and glycogenolysis. Muscle phosphorylase kinase, which activates glycogen phosphorylase, is a tetramer of four different subunits, α , β , γ , and δ . The α and β subunits contain serine residues that are phosphorylated by cAMP-dependent protein kinase. The δ subunit is identical

to the Ca²⁺-binding protein **calmodulin** (see Chapter 42), and binds four Ca²⁺. The binding of Ca²⁺ activates the catalytic site of the γ subunit even while the enzyme is in the dephosphorylated b state; the phosphorylated a form is only fully activated in the presence of high concentrations of Ca²⁺.

Glycogenolysis in Liver Can Be cAMP-Independent

In the liver, there is cAMP-independent activation of glycogenolysis in response to stimulation of α_1 **adrenergic** receptors by epinephrine and norepinephrine. This involves mobilization of Ca²⁺ into the cytosol, followed by the stimulation of a **Ca²⁺/calmodulin-sensitive phosphorylase kinase**. cAMP-independent glycogenolysis is also activated by vasopressin, oxytocin, and angiotensin II acting either through calcium or the phosphatidylinositol bisphosphate pathway (see Figure 42-10).

Protein Phosphatase-1 Inactivates Glycogen Phosphorylase

Both phosphorylase a and phosphorylase kinase a are dephosphorylated and inactivated by **protein phosphatase-1**. Protein phosphatase-1 is inhibited by a protein, **inhibitor-1**, which is active only after it has been phosphorylated by cAMP-dependent protein kinase. Thus, cAMP controls both the activation and inactivation of phosphorylase (Figure 18-6). **Insulin** reinforces this effect by inhibiting the activation of phosphorylase b. It does this indirectly by increasing uptake of glucose, leading to increased formation of glucose-6-phosphate, which is an inhibitor of phosphorylase kinase.

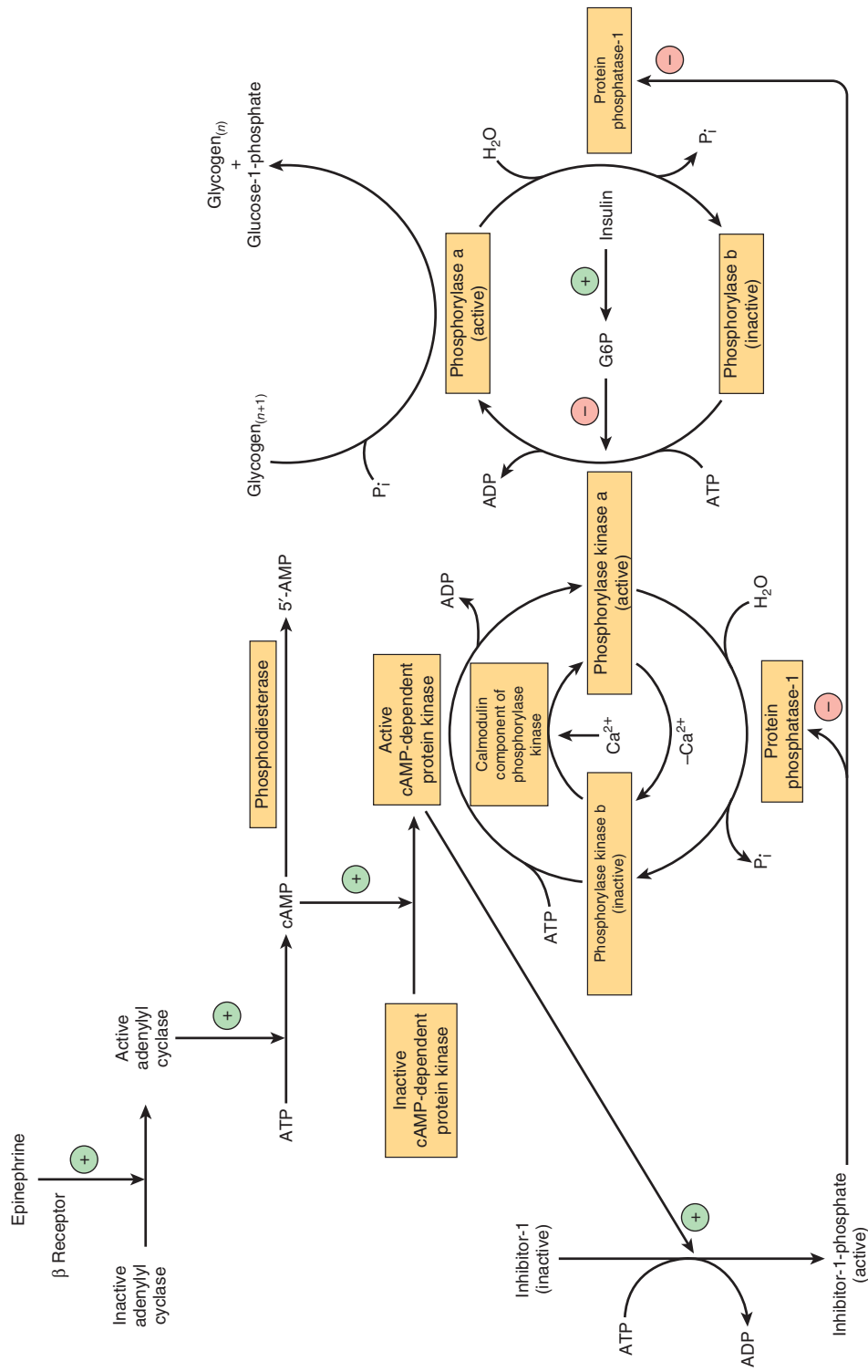

FIGURE 18-6 Control of glycogen phosphorylase in muscle. The sequence of reactions arranged as a cascade allows amplification of the hormonal signal at each step. (G6P, glucose 6-phosphate; n , number of glucose residues.)

The Activities of Glycogen Synthase & Phosphorylase Are Reciprocally Regulated

There are different isoenzymes of glycogen synthase in liver, muscle, and brain. Like phosphorylase, glycogen synthase exists in both phosphorylated and nonphosphorylated states, and the effect of phosphorylation is the reverse of that seen in phosphorylase (Figure 18–7). Active **glycogen synthase a** is dephosphorylated and inactive **glycogen synthase b** is phosphorylated.

Six different protein kinases act on glycogen synthase, and there are at least nine different serine residues in the enzyme that can be phosphorylated. Two of the protein kinases are Ca^{2+} /calmodulin dependent (one of these is phosphorylase kinase). Another kinase is cAMP-dependent protein kinase, which allows cAMP-mediated hormonal action to inhibit glycogen synthesis synchronously with the activation of glycogenolysis. Insulin also promotes glycogenesis in muscle at the same time as inhibiting glycogenolysis by raising glucose-6-phosphate concentrations, which stimulates the dephosphorylation and activation of glycogen synthase. Dephosphorylation of glycogen synthase b is carried out by

protein phosphatase-1, which is under the control of cAMP-dependent protein kinase.

GLYCOGEN METABOLISM IS REGULATED BY A BALANCE IN ACTIVITIES BETWEEN GLYCOGEN SYNTHASE & PHOSPHORYLASE

At the same time as phosphorylase is activated by a rise in concentration of cAMP (via phosphorylase kinase), glycogen synthase is converted to the inactive form; both effects are mediated via **cAMP-dependent protein kinase** (Figure 18–8). Thus, inhibition of glycogenolysis enhances net glycogenesis, and inhibition of glycogenesis enhances net glycogenolysis. Also, the dephosphorylation of phosphorylase a, phosphorylase kinase, and glycogen synthase b is catalyzed by a single enzyme with broad specificity—**protein phosphatase-1**. In turn, protein phosphatase-1 is inhibited by cAMP-dependent protein kinase via inhibitor-1. Thus, glycogenolysis can be terminated and glycogenesis can be stimulated, or vice versa, synchronously, because both processes are dependent on the activity of

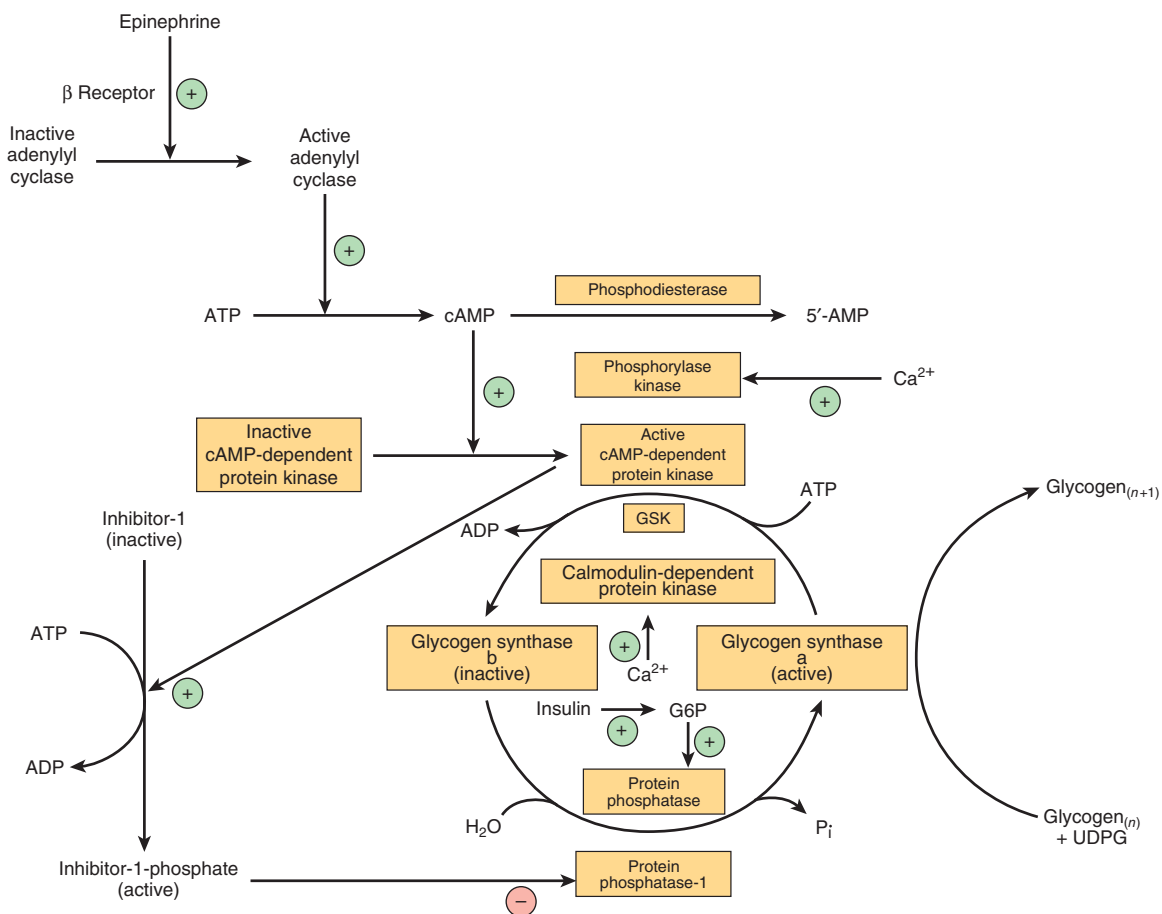

FIGURE 18–7 Control of glycogen synthase in muscle. (G6P, glucose-6-phosphate; GSK, glycogen synthase kinase; n , number of glucose residues.)

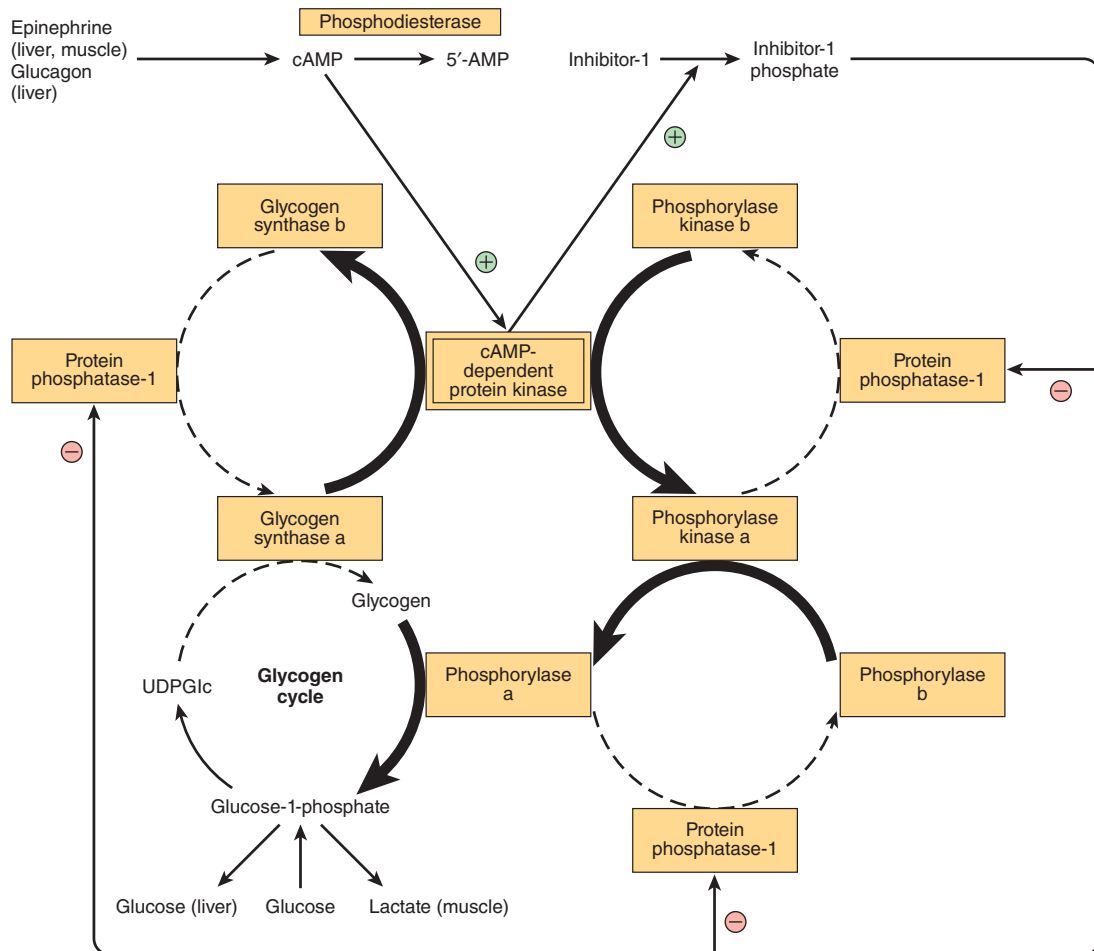

FIGURE 18-8 Coordinated control of glycogenolysis and glycogenesis by cAMP-dependent protein kinase. The reactions that lead to glycogenolysis as a result of an increase in cAMP concentrations are shown with bold arrows, and those that are inhibited by activation of protein phosphatase-1 are shown with dashed arrows. The reverse occurs when cAMP concentrations decrease as a result of phosphodiesterase activity, leading to glycogenesis.

cAMP-dependent protein kinase. Both phosphorylase kinase and glycogen synthase may be reversibly phosphorylated at more than one site by separate kinases and phosphatases. These secondary phosphorylations modify the sensitivity of the primary sites to phosphorylation and dephosphorylation (**multisite phosphorylation**). Also, they allow insulin, by way of increased glucose 6-phosphate, to have effects that act reciprocally to those of cAMP (see Figures 18-6 and 18-7).

CLINICAL ASPECTS

Glycogen Storage Diseases Are Inherited

“Glycogen storage disease” is a generic term to describe a group of inherited disorders characterized by deposition of an abnormal type or quantity of glycogen in tissues, or failure to mobilize glycogen. The principal diseases are summarized in Table 18-2.

SUMMARY

- Glycogen represents the principal storage carbohydrate in the body, mainly in the liver and muscle.
- In the liver, its major function is to provide glucose for extrahepatic tissues. In muscle, it serves mainly as a ready source of metabolic fuel for use in muscle. Muscle lacks glucose-6-phosphatase and cannot release free glucose from glycogen.
- Glycogen is synthesized from glucose by the pathway of glycogenesis. It is broken down by a separate pathway, glycogenolysis.
- Cyclic AMP integrates the regulation of glycogenolysis and glycogenesis by promoting the simultaneous activation of phosphorylase and inhibition of glycogen synthase. Insulin acts reciprocally by inhibiting glycogenolysis and stimulating glycogenesis.
- Inherited deficiencies of enzymes of glycogen metabolism in both liver and muscle cause glycogen storage diseases.

REFERENCES

- Alonso MD, Lomako J, Lomako WM, et al: A new look at the biogenesis of glycogen. *FASEB J* 1995;9:1126.
- Bollen M, Keppens S, Stalmans W: Specific features of glycogen metabolism in the liver. *Biochem J* 1998;336:19.
- DiMauro S, Spiegel R: Progress and problems in muscle glycogenoses. *Acta Myol* 2011;30:96.
- Ferrer JC, Favre C, Gomis RR, et al: Control of glycogen deposition. *FEBS Lett* 2003;546:127–132.
- Forde JE, Dale TC: Glycogen synthase kinase 3: a key regulator of cellular fate. *Cell Mol Life Sci* 2007;64:1930.
- Gazzerro E, Andreu AL: Neuromuscular disorders of glycogen metabolism. *Curr Neurol Neurosci Rep* 2013;13:333.
- Graham TE, Yuan Z, Hill AK, et al: The regulation of muscle glycogen: the granule and its proteins. *Acta Physiol (Oxf)* 2010;199:489.
- Greenberg CC, Jurczak MJ, Danos AM, et al: Glycogen branches out: new perspectives on the role of glycogen metabolism in the integration of metabolic pathways. *Am J Physiol Endocrinol Metab* 2006;291:E1.
- Jensen J, Lai YC: Regulation of muscle glycogen synthase phosphorylation and kinetic properties by insulin, exercise, adrenaline and role in insulin resistance. *Arch Physiol Biochem* 2009;115:13.
- Jensen TE, Richter EA: Regulation of glucose and glycogen metabolism during and after exercise. *J Physiol* 2012;590:1069.
- McGarry JD, Kuwajima M, Newgard CB, et al: From dietary glucose to liver glycogen: the full circle round. *Annu Rev Nutr* 1987;7:51.
- Meléndez-Hevia E, Waddell TG, Shelton ED: Optimization of molecular design in the evolution of metabolism: the glycogen molecule. *Biochem J* 1993;295:477.
- Ozen H: Glycogen storage diseases: new perspectives. *World J Gastroenterol* 2007;13:2541.
- Palm DC, Rohwer JM: Regulation of glycogen synthase from mammalian skeletal muscle—a unifying view of allosteric and covalent regulation. *FEBS J* 2013;280:2.
- Philp A, Hargreaves M: More than a store: regulatory roles for glycogen in skeletal muscle adaptation to exercise. *Am J Physiol Endocrinol Metab* 2012;302:E1343.
- Radziuk J, Pye S: Hepatic glucose uptake, gluconeogenesis and the regulation of glycogen synthesis. *Diabetes Metab Res Rev* 2001;17(4):250.
- Roach PJ, Depaoli-Roach AA: Glycogen and its metabolism: some new developments and old themes. *Biochem J* 2012;441:763.
- Roden M, Bernroider E: Hepatic glucose metabolism in humans—its role in health and disease. *Best Pract Res Clin Endocrinol Metab* 2003;17:365.
- Rybicka KK: Glycosomes—the organelles of glycogen metabolism. *Tissue Cell* 1996;28:254.
- Shearer J, Graham TE: New perspectives on the storage and organization of muscle glycogen. *Can J Appl Physiol* 2002;27:179.
- Shin YS: Glycogen storage disease: clinical, biochemical, and molecular heterogeneity. *Semin Pediatr Neurol* 2006;13:115.
- Wolfsdorf JI, Holm IA: Glycogen storage diseases. Phenotypic, genetic, and biochemical characteristics, and therapy. *Endocrinol Metab Clin North Am* 1999;28:801.
- Yeaman SJ, Armstrong JL, Bonavaud SM, et al: Regulation of glycogen synthesis in human muscle cells. *Biochem Soc Trans* 2001;29:537.

Gluconeogenesis & the Control of Blood Glucose

David A. Bender, PhD & Peter A. Mayes, PhD, DSc

OBJECTIVES

After studying this chapter, you should be able to:

- Explain the importance of gluconeogenesis in glucose homeostasis.
- Describe the pathway of gluconeogenesis, how irreversible enzymes of glycolysis are bypassed, and how glycolysis and gluconeogenesis are regulated reciprocally.
- Explain how plasma glucose concentration is maintained within narrow limits in the fed and fasting states.

BIOMEDICAL IMPORTANCE

Gluconeogenesis is the process of synthesizing glucose or glycogen from noncarbohydrate precursors. The major substrates are the glucogenic amino acids (see Chapter 29), lactate, glycerol, and propionate. Liver and kidney are the major gluconeogenic tissues; the kidney may contribute up to 40% of total glucose synthesis in the fasting state and more in starvation. The key gluconeogenic enzymes are expressed in the small intestine, but it is unclear whether or not there is significant glucose production by the intestine in the fasting state.

A supply of glucose is necessary especially for the nervous system and erythrocytes. After an overnight fast, glycogenolysis (see Chapter 18) and gluconeogenesis make approximately equal contributions to blood glucose; as glycogen reserves are depleted, so gluconeogenesis becomes progressively more important.

Failure of gluconeogenesis is usually fatal. **Hypoglycemia** causes brain dysfunction, which can lead to coma and death. Glucose is also important in maintaining adequate concentrations of intermediates of the citric acid cycle (see Chapter 16) even when fatty acids are the main source of acetyl-CoA in the tissues. In addition, gluconeogenesis clears lactate produced by muscle and erythrocytes, and glycerol produced by adipose tissue. In ruminants, propionate is a product of rumen metabolism of carbohydrates, and is a major substrate for gluconeogenesis.

Excessive gluconeogenesis occurs in **critically ill patients** in response to injury and infection, contributing to **hyperglycemia** which is associated with a poor outcome. Hyperglycemia leads to changes in osmolality of body fluids, impaired blood flow, intracellular acidosis and increased superoxide radical production (see Chapter 45), resulting in deranged endothelial and immune system function and impaired blood

coagulation. Excessive gluconeogenesis is also a contributory factor to hyperglycemia in **type 2 diabetes** because of impaired downregulation in response to insulin.

GLUCONEOGENESIS INVOLVES GLYCOLYSIS, THE CITRIC ACID CYCLE, PLUS SOME SPECIAL REACTIONS

Thermodynamic Barriers Prevent a Simple Reversal of Glycolysis

Three nonequilibrium reactions in glycolysis (see Chapter 17), catalyzed by hexokinase, phosphofructokinase and pyruvate kinase, prevent simple reversal of glycolysis for glucose synthesis (**Figure 19–1**). They are circumvented as follows.

Pyruvate & Phosphoenolpyruvate

Reversal of the reaction catalyzed by pyruvate kinase in glycolysis involves two endothermic reactions. Mitochondrial **pyruvate carboxylase** catalyzes the carboxylation of pyruvate to oxaloacetate, an ATP-requiring reaction in which the vitamin biotin is the coenzyme. Biotin binds CO₂ from bicarbonate as carboxybiotin prior to the addition of the CO₂ to pyruvate (see **Figure 44–17**). The resultant oxaloacetate is reduced to malate, exported from the mitochondrion into the cytosol and there oxidized back to oxaloacetate. A second enzyme, **phosphoenolpyruvate carboxykinase**, catalyzes the decarboxylation and phosphorylation of oxaloacetate to

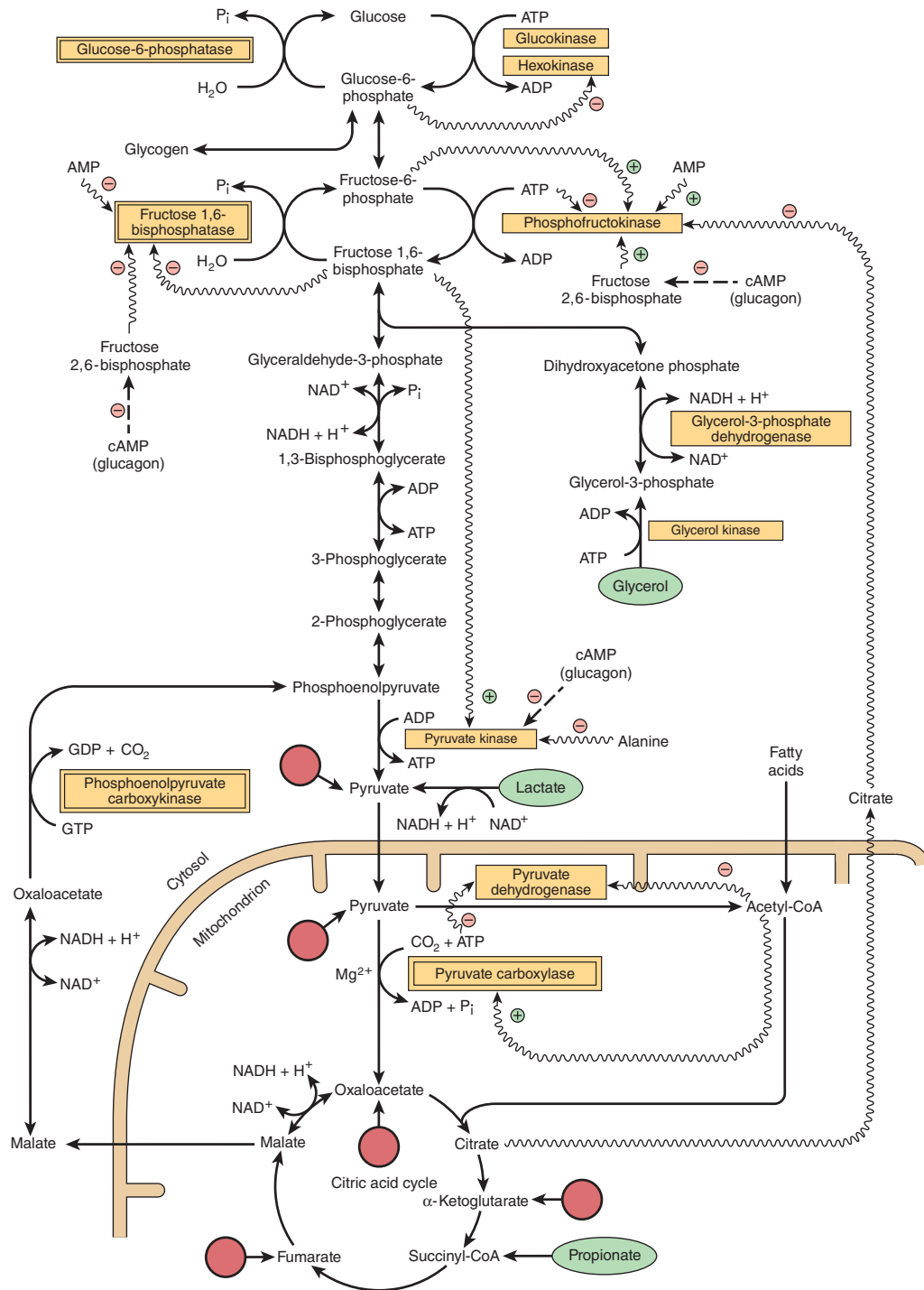

FIGURE 19-1 Major pathways and regulation of gluconeogenesis and glycolysis in the liver. Entry points of glucogenic amino acids after transamination are indicated by arrows extended from circles (see also Figure 16-4). The key gluconeogenic enzymes are enclosed in double-bordered boxes. The ATP required for gluconeogenesis is supplied by the oxidation of fatty acids. Propionate is of quantitative importance only in ruminants. Arrows with wavy shafts signify allosteric effects; dash-shafted arrows, covalent modification by reversible phosphorylation. High concentrations of alanine act as a “gluconeogenic signal” by inhibiting glycolysis at the pyruvate kinase step.

phosphoenolpyruvate using GTP as the phosphate donor. In liver and kidney, the reaction of succinate thiokinase in the citric acid cycle (see Chapter 16) produces GTP (rather than ATP as in other tissues), and this GTP is used for the reaction

of phosphoenolpyruvate carboxykinase, thus providing a link between citric acid cycle activity and gluconeogenesis, to prevent excessive removal of oxaloacetate for gluconeogenesis, which would impair citric acid cycle activity.

Fructose 1,6-Bisphosphate & Fructose-6-Phosphate

The conversion of fructose 1,6-bisphosphate to fructose-6-phosphate, for the reversal of glycolysis, is catalyzed by **fructose 1,6-bisphosphatase**. Its presence determines whether a tissue is capable of synthesizing glucose (or glycogen) not only from pyruvate, but also from triose phosphates. It is present in liver, kidney, and skeletal muscle, but is probably absent from heart and smooth muscle.

Glucose-6-Phosphate & Glucose

The conversion of glucose-6-phosphate to glucose is catalyzed by **glucose-6-phosphatase**. It is present in liver and kidney, but absent from muscle, which, therefore, cannot export glucose into the bloodstream.

Glucose-1-Phosphate & Glycogen

The breakdown of glycogen to glucose-1-phosphate is catalyzed by phosphorylase. Glycogen synthesis involves a different pathway via uridine diphosphate glucose and **glycogen synthase** (see Figure 18–1).

The relationships between gluconeogenesis and the glycolytic pathway are shown in Figure 19–1. After transamination or deamination, glucogenic amino acids yield either pyruvate or intermediates of the citric acid cycle. Therefore, the reactions described above can account for the conversion of both lactate and glucogenic amino acids to glucose or glycogen.

Propionate is a major precursor of glucose in ruminants; it enters gluconeogenesis via the citric acid cycle. After esterification with CoA, propionyl-CoA is carboxylated to D-methylmalonyl-CoA, catalyzed by **propionyl-CoA carboxylase**, a biotin-dependent enzyme (Figure 19–2). **Methylmalonyl-CoA racemase** catalyzes the conversion of D-methylmalonyl-CoA to L-methylmalonyl-CoA, which then undergoes isomerization to succinyl-CoA catalyzed

by **methylmalonyl-CoA mutase**. In nonruminants, including human beings, propionate arises from the β -oxidation of odd-chain fatty acids that occur in ruminant lipids (see Chapter 22), as well as the oxidation of isoleucine and the side chain of cholesterol, and is a (relatively minor) substrate for gluconeogenesis. Methylmalonyl-CoA mutase is a vitamin B₁₂-dependent enzyme, and in deficiency methylmalonic acid is excreted in the urine (**methylmalonic aciduria**).

Glycerol is released from adipose tissue as a result of lipolysis of lipoprotein triacylglycerol in the fed state; it may be used for reesterification of free fatty acids to triacylglycerol, or may be a substrate for gluconeogenesis in the liver. In the fasting state, glycerol released from lipolysis of adipose tissue triacylglycerol is used as a substrate for gluconeogenesis in the liver and kidneys.

GLYCOLYSIS & GLUCONEOGENESIS SHARE THE SAME PATHWAY BUT IN OPPOSITE DIRECTIONS, AND ARE RECIPROCALLY REGULATED

Changes in the availability of substrates are responsible for most changes in metabolism either directly or indirectly acting via changes in hormone secretion. Three mechanisms are responsible for regulating the activity of enzymes concerned in carbohydrate metabolism: (1) changes in the rate of enzyme synthesis, (2) covalent modification by reversible phosphorylation, and (3) allosteric effects.

Induction & Repression of Key Enzymes Requires Several Hours

The changes in enzyme activity in the liver that occur under various metabolic conditions are listed in Table 19–1. The enzymes involved catalyze physiologically irreversible non-equilibrium reactions. The effects are generally reinforced

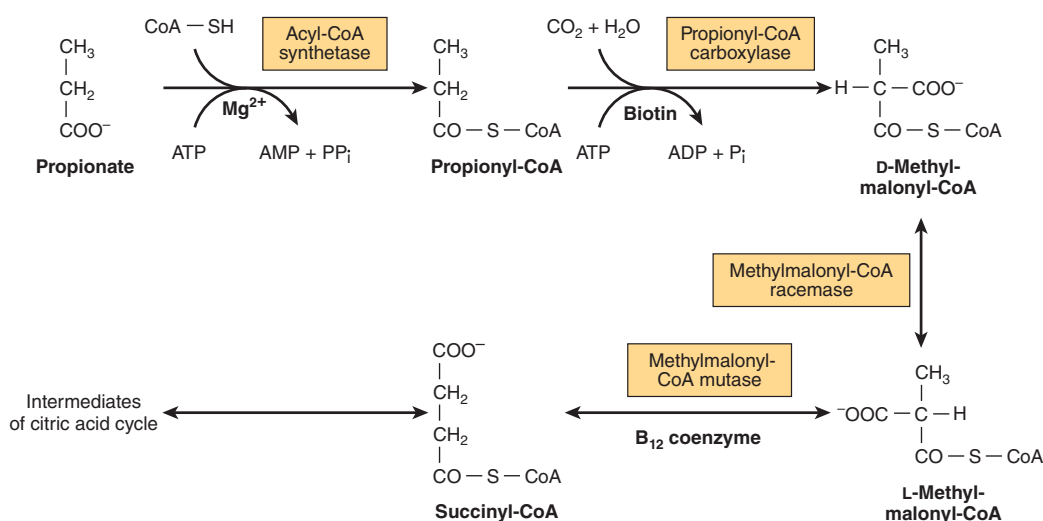

FIGURE 19–2 Metabolism of propionate.

TABLE 19–1 Regulatory and Adaptive Enzymes Associated with Carbohydrate Metabolism

	Activity in		Inducer	Repressor	Activator	Inhibitor
	Carbohydrate Feeding	Fasting and Diabetes				
Glycogenolysis, glycolysis, and pyruvate oxidation						
Glycogen synthase	↑	↓			Insulin, glucose-6-phosphate	Glucagon
Hexokinase						Glucose-6-phosphate
Glucokinase	↑	↓	Insulin	Glucagon		
Phosphofructokinase-1	↑	↓	Insulin	Glucagon	5' AMP, fructose-6-phosphate, fructose 2,6-bisphosphate, P _i	Citrate, ATP, glucagon
Pyruvate kinase	↑	↓	Insulin, fructose	Glucagon	Fructose 1,6-bisphosphate, insulin	ATP, alanine, glucagon, norepinephrine
Pyruvate dehydrogenase	↑	↓			CoA, NAD ⁺ , insulin, ADP, pyruvate	Acetyl CoA, NADH, ATP (fatty acids, ketone bodies)
Gluconeogenesis						
Pyruvate carboxylase	↓	↑	Glucocorticoids, glucagon, epinephrine	Insulin	Acetyl CoA	ADP
Phosphoenolpyruvate carboxykinase	↓	↑	Glucocorticoids, glucagon, epinephrine	Insulin	Glucagon	
Glucose 6-phosphatase	↓	↑	Glucocorticoids, glucagon, epinephrine	Insulin		

because the activity of the enzymes catalyzing the reactions in the opposite direction varies reciprocally (see Figure 19–1). The enzymes involved in the utilization of glucose (ie, those of glycolysis and lipogenesis) become more active when there is a superfluity of glucose, and under these conditions the enzymes of gluconeogenesis have low activity. Insulin, secreted in response to increased blood glucose, enhances the synthesis of the key enzymes in glycolysis. It also antagonizes the effect of the glucocorticoids and glucagon-stimulated cAMP, which induce synthesis of the key enzymes of gluconeogenesis.

Covalent Modification by Reversible Phosphorylation Is Rapid

Glucagon and **epinephrine**, hormones that are responsive to a decrease in blood glucose, inhibit glycolysis and stimulate gluconeogenesis in the liver by increasing the concentration of cAMP. This in turn activates cAMP-dependent protein kinase, leading to the phosphorylation and inactivation of **pyruvate kinase**. They also affect the concentration of fructose 2,6-bisphosphate and therefore glycolysis and gluconeogenesis, as described below.

Allosteric Modification Is Instantaneous

In gluconeogenesis, pyruvate carboxylase, which catalyzes the synthesis of oxaloacetate from pyruvate, requires acetyl-CoA as an **allosteric activator**. The addition of acetyl-CoA results in a change in the tertiary structure of the protein, lowering the K_m for bicarbonate. This means that as acetyl-CoA is formed from pyruvate, it automatically ensures the provision of oxaloacetate and, therefore, its further oxidation in the citric acid cycle, by activating pyruvate carboxylase. The activation of pyruvate carboxylase and the reciprocal inhibition of pyruvate dehydrogenase by acetyl-CoA derived from the oxidation of fatty acids explain the action of fatty acid oxidation in sparing the oxidation of pyruvate (and hence glucose) and in stimulating gluconeogenesis. The reciprocal relationship between these two enzymes alters the metabolic fate of pyruvate as the tissue changes from carbohydrate oxidation (glycolysis) to gluconeogenesis during the transition from the fed to fasting state (see Figure 19–1). A major role of fatty acid oxidation in promoting gluconeogenesis is to supply the ATP that is required.

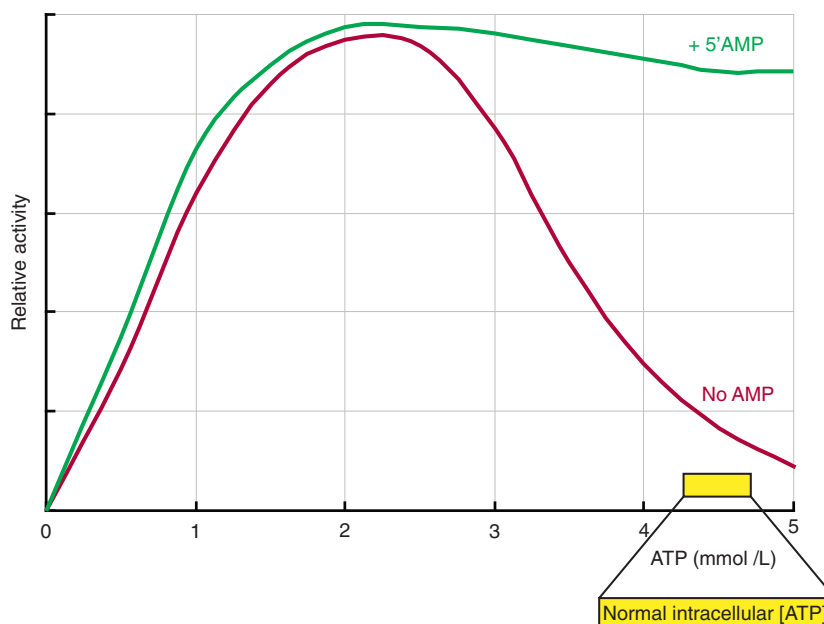

FIGURE 19-3 The inhibition of phosphofructokinase-1 by ATP and relief of inhibition by ATP.

Phosphofructokinase (phosphofructokinase-1) occupies a key position in regulating glycolysis and is also subject to feedback control. It is inhibited by citrate and by normal intracellular concentrations of ATP and is activated by 5' AMP. At the normal intracellular [ATP] the enzyme is about 90% inhibited; this inhibition is reversed by 5' AMP (Figure 19-3).

5' AMP acts as an indicator of the energy status of the cell. The presence of **adenylyl kinase** in liver and many other tissues allows rapid equilibration of the reaction



Thus, when ATP is used in energy-requiring processes, resulting in formation of ADP, [AMP] increases. A relatively small decrease in [ATP] causes a several-fold increase in [AMP], so that [AMP] acts as a metabolic amplifier of a small change in [ATP], and hence a sensitive signal of the energy state of the cell. The activity of phosphofructokinase-1 is thus regulated in response to the energy status of the cell to control the quantity of carbohydrate undergoing glycolysis prior to its entry into the citric acid cycle. At the same time, AMP activates glycogen phosphorylase, so increasing glycogenolysis. A consequence of the inhibition of phosphofructokinase-1 by ATP is an accumulation of glucose-6-phosphate, which in turn inhibits further uptake of glucose in extrahepatic tissues by inhibition of hexokinase.

Fructose 2,6-Bisphosphate Plays a Unique Role in the Regulation of Glycolysis & Gluconeogenesis in Liver

The most potent positive allosteric activator of phosphofructokinase-1 and inhibitor of fructose 1,6-bisphosphatase in

liver is **fructose 2,6-bisphosphate**. It relieves inhibition of phosphofructokinase-1 by ATP and increases the affinity for fructose-6-phosphate. It inhibits fructose 1,6-bisphosphatase by increasing the K_m for fructose 1,6-bisphosphate. Its concentration is under both substrate (allosteric) and hormonal control (covalent modification) (Figure 19-4).

Fructose 2,6-bisphosphate is formed by phosphorylation of fructose-6-phosphate by **phosphofructokinase-2**. The same enzyme protein is also responsible for its breakdown, since it has **fructose 2,6-bisphosphatase** activity. This **bifunctional enzyme** is under the allosteric control of fructose-6-phosphate, which stimulates the kinase and inhibits the phosphatase. Hence, when there is an abundant supply of glucose, the concentration of fructose 2,6-bisphosphate increases, stimulating glycolysis by activating phosphofructokinase-1 and inhibiting fructose 1,6-bisphosphatase. In the fasting state, glucagon stimulates the production of cAMP, activating cAMP-dependent protein kinase, which in turn inactivates phosphofructokinase-2 and activates fructose 2,6-bisphosphatase by phosphorylation. Hence, gluconeogenesis is stimulated by a decrease in the concentration of fructose 2,6-bisphosphate, which inactivates phosphofructokinase-1 and relieves the inhibition of fructose 1,6-bisphosphatase. Xylulose 5-phosphate, an intermediate of the pentose phosphate pathway (see Chapter 20) activates the protein phosphatase that dephosphorylates the bifunctional enzyme, so increasing the formation of fructose 2,6-bisphosphate and increasing the rate of glycolysis. This leads to increased flux through glycolysis and the pentose phosphate pathway and increased fatty acid synthesis (see Chapter 23).

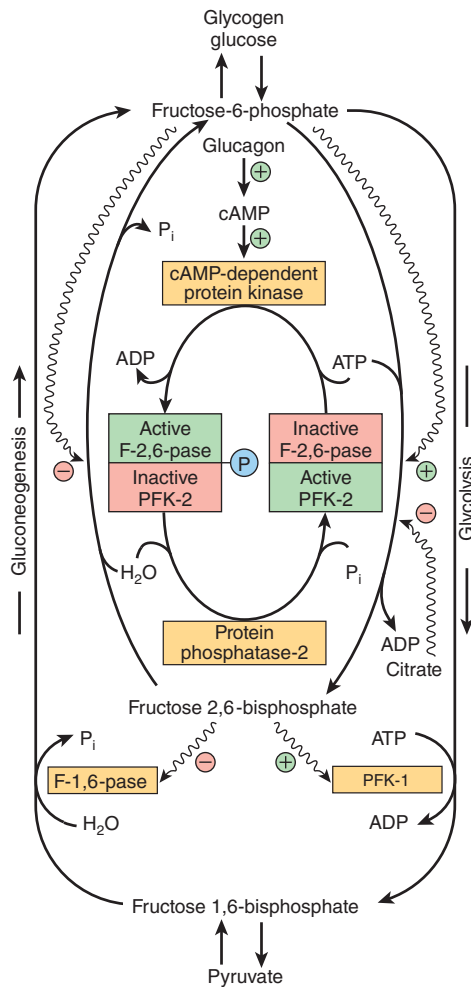

FIGURE 19–4 Control of glycolysis and gluconeogenesis in the liver by fructose 2,6-bisphosphate and the bifunctional enzyme PFK-2/F-2,6-Pase (6-phosphofructo-2-kinase/fructose 2,6-bisphosphatase). (F-1,6-Pase, fructose 1,6-bisphosphatase; PFK-1, phosphofructokinase-1 [6-phosphofructo-1-kinase].) Arrows with wavy shafts indicate allosteric effects.

Substrate (Futile) Cycles Allow Fine Tuning & Rapid Response

The control points in glycolysis and glycogen metabolism involve a cycle of phosphorylation and dephosphorylation catalyzed by glucokinase and glucose-6-phosphatase; phosphofructokinase-1 and fructose 1,6-bisphosphatase; pyruvate kinase, pyruvate carboxylase, and phosphoenolpyruvate carboxykinase; and glycogen synthase and phosphorylase. It would seem obvious that these opposing enzymes are regulated in such a way that when those involved in glycolysis are active, those involved in gluconeogenesis are inactive, since otherwise there would be cycling between phosphorylated and nonphosphorylated intermediates, with net hydrolysis of ATP. While this is so, in muscle both phosphofructokinase and fructose 1,6-bisphosphatase have some activity at all times, so that there is indeed some measure of (wasteful) substrate cycling. This permits the very rapid increase in the rate of glycolysis necessary for muscle contraction. At rest the rate

of phosphofructokinase activity is some 10-fold higher than that of fructose 1,6-bisphosphatase; in anticipation of muscle contraction, the activity of both enzymes increases, fructose 1,6-bisphosphatase 10 times more than phosphofructokinase, maintaining the same net rate of glycolysis. At the start of muscle contraction, the activity of phosphofructokinase increases further, and that of fructose 1,6-bisphosphatase falls, so increasing the net rate of glycolysis (and hence ATP formation) as much as a 1000-fold.

THE BLOOD CONCENTRATION OF GLUCOSE IS REGULATED WITHIN NARROW LIMITS

In the postabsorptive state, the concentration of blood glucose in most mammals is maintained between 4.5 and 5.5 mmol/L. After the ingestion of a carbohydrate meal, it may rise to 6.5 to 7.2 mmol/L, and in starvation, it may fall to 3.3 to 3.9 mmol/L. A sudden decrease in blood glucose (eg, in response to insulin overdose) causes convulsions, because of the dependence of the brain on a supply of glucose. However, much lower concentrations can be tolerated if hypoglycemia develops slowly enough for adaptation to occur. The blood glucose level in birds is considerably higher (14.0 mmol/L) and in ruminants considerably lower (approximately 2.2 mmol/L in sheep and 3.3 mmol/L in cattle). These lower normal levels appear to be associated with the fact that ruminants ferment virtually all dietary carbohydrate to short-chain fatty acids, and these largely replace glucose as the main metabolic fuel of the tissues in the fed state.

BLOOD GLUCOSE IS DERIVED FROM THE DIET, GLUCONEOGENESIS, & GLYCOGENOLYSIS

The digestible dietary carbohydrates yield glucose, galactose, and fructose that are transported to the liver via the **hepatic portal vein**. Galactose and fructose are readily converted to glucose in the liver (see Chapter 20).

Glucose is formed from two groups of compounds that undergo gluconeogenesis (see Figures 16–4 and 19–1): (1) those which involve a direct net conversion to glucose, including most **amino acids** and **propionate**; and (2) those which are the products of the metabolism of glucose in tissues. Thus **lactate**, formed by glycolysis in skeletal muscle and erythrocytes, is transported to the liver and kidney where it reforms glucose, which again becomes available via the circulation for oxidation in the tissues. This process is known as the **Cori cycle**, or the **lactic acid cycle** (Figure 19–5).

In the fasting state, there is a considerable output of alanine from skeletal muscle, far in excess of the amount in the muscle proteins that are being catabolized. It is formed by

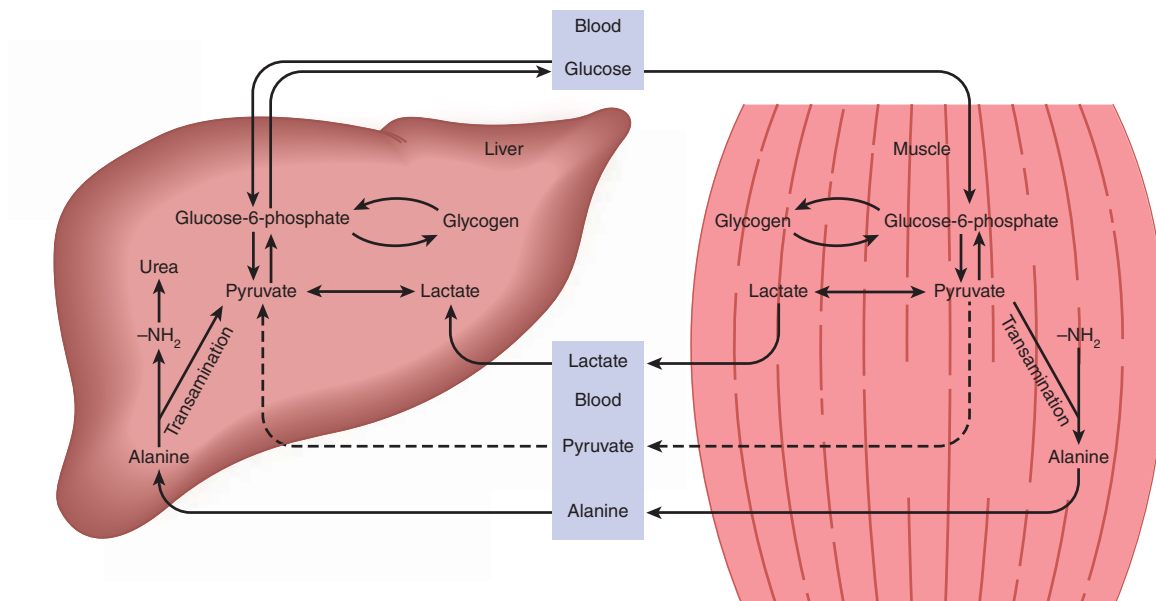

FIGURE 19-5 The lactic acid (Cori) cycle and glucose-alanine cycles.

transamination of pyruvate produced by glycolysis of muscle glycogen, and is exported to the liver, where, after transamination back to pyruvate, it is a substrate for gluconeogenesis. This **glucose-alanine cycle** (see Figure 19-5) thus provides an indirect way of utilizing muscle glycogen to maintain blood glucose in the fasting state. The ATP required for the hepatic synthesis of glucose from pyruvate is derived from the oxidation of fatty acids.

Glucose is also formed from liver glycogen by glycogenolysis (see Chapter 18).

Metabolic & Hormonal Mechanisms Regulate the Concentration of Blood Glucose

The maintenance of a stable blood glucose concentration is one of the most finely regulated of all homeostatic mechanisms, involving the liver, extrahepatic tissues, and several hormones. Liver cells are freely permeable to glucose in either

direction (via the GLUT 2 transporter), whereas cells of extrahepatic tissues (apart from pancreatic β -islets) are relatively impermeable, and their unidirectional glucose transporters are regulated by insulin. As a result, uptake from the bloodstream is the rate-limiting step in the utilization of glucose in extrahepatic tissues. The role of various glucose transporter proteins found in cell membranes is shown in **Table 19-2**.

Glucokinase Is Important in Regulating Blood Glucose After a Meal

Hexokinase has a low K_m for glucose, and in the liver it is saturated and acting at a constant rate under all normal conditions. It thus acts to ensure an adequate rate of glycolysis to meet the liver's needs. Glucokinase has a considerably higher K_m (lower affinity) for glucose, so that its activity increases with increases in the concentration of glucose in the hepatic portal vein (**Figure 19-6**). It permits hepatic uptake of large amounts of glucose after a carbohydrate meal, for glycogen

TABLE 19-2 Major Glucose Transporters

	Tissue Location	Functions
Facilitative bidirectional transporters		
GLUT 1	Brain, kidney, colon, placenta, erythrocytes	Glucose uptake
GLUT 2	Liver, pancreatic β cell, small intestine, kidney	Rapid uptake or release of glucose
GLUT 3	Brain, kidney, placenta	Glucose uptake
GLUT 4	Heart and skeletal muscle, adipose tissue	Insulin-stimulated glucose uptake
GLUT 5	Small intestine	Absorption of fructose
Sodium-dependent unidirectional transporter		
SGLT 1	Small intestine and kidney	Active uptake of glucose against a concentration gradient

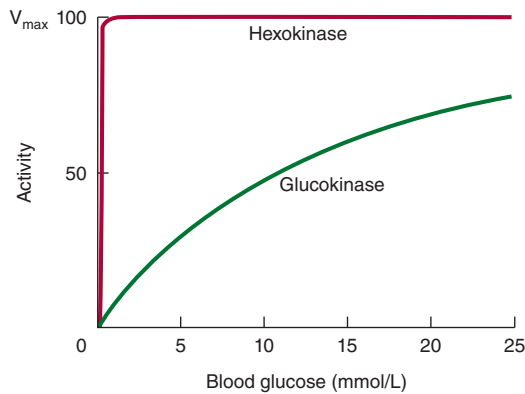

FIGURE 19-6 Variation in glucose phosphorylating activity of hexokinase and glucokinase with increasing blood glucose concentration. The K_m for glucose of hexokinase is 0.05 mmol/L and of glucokinase is 10 mmol/L.

and fatty acid synthesis, so that while the concentration of glucose in the hepatic portal vein may reach 20 mmol/L after a meal, that leaving the liver into the peripheral circulation does not normally exceed 8 to 9 mmol/L. Glucokinase is absent from the liver of ruminants, which have little glucose entering the portal circulation from the intestines.

At normal peripheral blood glucose concentrations (4.5–5.5 mmol/L), the liver is a net producer of glucose. However, as the glucose level rises, the output of glucose ceases, and there is a net uptake.

Insulin and Glucagon Play a Central Role in Regulating Blood Glucose

In addition to the direct effects of hyperglycemia in enhancing the uptake of glucose into the liver, the hormone **insulin** plays a central role in regulating blood glucose. It is produced by the β cells of the islets of Langerhans in the pancreas in response to hyperglycemia. The β -islet cells are freely permeable to glucose via the GLUT 2 transporter, and the glucose is phosphorylated by glucokinase. Therefore, increasing blood glucose increases metabolic flux through glycolysis, the citric acid cycle, and the generation of ATP. The increase in [ATP] inhibits ATP-sensitive K^+ channels, causing depolarization of

the cell membrane, which increases Ca^{2+} influx via voltage-sensitive Ca^{2+} channels, stimulating exocytosis of insulin. Thus, the concentration of insulin in the blood parallels that of the blood glucose. Other substances causing release of insulin from the pancreas include amino acids, nonesterified fatty acids, ketone bodies, glucagon, secretin, and the sulfonylurea drugs tolbutamide and glyburide. These drugs are used to stimulate insulin secretion in type 2 diabetes mellitus via the ATP-sensitive K^+ channels. Epinephrine and norepinephrine block the release of insulin. Insulin acts to lower blood glucose immediately by enhancing glucose transport into adipose tissue and muscle by recruitment of glucose transporters (GLUT 4) from the interior of the cell to the plasma membrane. Although it does not affect glucose uptake into the liver directly, insulin does enhance long-term uptake as a result of its actions on the enzymes controlling glycolysis, glycogenesis, and gluconeogenesis (see Chapter 18 and Table 19–1).

Glucagon is the hormone produced by the α cells of the pancreatic islets in response to hypoglycemia. In the liver, it stimulates glycogenolysis by activating glycogen phosphorylase. Unlike epinephrine, glucagon does not have an effect on muscle phosphorylase. Glucagon also enhances gluconeogenesis from amino acids and lactate. In all these actions, glucagon acts via generation of cAMP (see Table 19–1). Both hepatic glycogenolysis and gluconeogenesis contribute to the **hyperglycemic effect** of glucagon, whose actions oppose those of insulin. Most of the endogenous glucagon (and insulin) is cleared from the circulation by the liver (Table 19–3).

Other Hormones Affect Blood Glucose

The **anterior pituitary gland** secretes hormones that tend to elevate blood glucose and therefore antagonize the action of insulin. These are growth hormone, ACTH (corticotropin), and possibly other “diabetogenic” hormones. Growth hormone secretion is stimulated by hypoglycemia; it decreases glucose uptake in muscle. Some of this effect may be indirect, since it stimulates mobilization of nonesterified fatty acids from adipose tissue, which themselves inhibit glucose utilization. The **glucocorticoids** (11-oxysteroids) are secreted by the adrenal cortex, and are also synthesized in an unregulated manner in adipose tissue. They act to increase gluconeogenesis

TABLE 19-3 Tissue Responses to Insulin and Glucagon

	Liver	Adipose Tissue	Muscle
Increased by insulin	Fatty acid synthesis Glycogen synthesis Protein synthesis	Glucose uptake Fatty acid synthesis	Glucose uptake Glycogen synthesis Protein synthesis
Decreased by insulin	Ketogenesis Gluconeogenesis	Lipolysis	
Increased by glucagon	Glycogenolysis Gluconeogenesis Ketogenesis	Lipolysis	

as a result of enhanced hepatic catabolism of amino acids, due to induction of aminotransferases (and other enzymes such as tryptophan dioxygenase) and key enzymes of gluconeogenesis. In addition, glucocorticoids inhibit the utilization of glucose in extrahepatic tissues. In all these actions, glucocorticoids act in a manner antagonistic to insulin. A number of **cytokines** secreted by macrophages infiltrating adipose tissue also have insulin antagonistic actions; together with glucocorticoids secreted by adipose tissue, this explains the insulin resistance that commonly occurs in obese people.

Epinephrine is secreted by the adrenal medulla as a result of stressful stimuli (fear, excitement, hemorrhage, hypoxia, hypoglycemia, etc) and leads to glycogenolysis in liver and muscle owing to stimulation of phosphorylase via generation of cAMP. In muscle, glycogenolysis results in increased glycolysis, whereas in liver it results in the release of glucose into the bloodstream.

FURTHER CLINICAL ASPECTS

Glucosuria Occurs When the Renal Threshold for Glucose Is Exceeded

When the blood glucose concentration rises above about 10 mmol/L, the kidney also exerts a (passive) regulatory effect. Glucose is continuously filtered by the glomeruli, but is normally completely reabsorbed in the renal tubules by active transport. The capacity of the tubular system to reabsorb glucose is limited to a rate of about 2 mmol/min, and in hyperglycemia (as occurs in poorly controlled diabetes mellitus), the glomerular filtrate may contain more glucose than can be

reabsorbed, resulting in **glucosuria** when the **renal threshold** for glucose is exceeded.

Hypoglycemia May Occur During Pregnancy & in the Neonate

During pregnancy, fetal glucose consumption increases and there is a risk of maternal, and possibly fetal, hypoglycemia, particularly if there are long intervals between meals or at night. Furthermore, premature and low-birth-weight babies are more susceptible to hypoglycemia, since they have little adipose tissue to provide nonesterified fatty acids. The enzymes of gluconeogenesis may not be fully developed at this time, and gluconeogenesis is anyway dependent on a supply of nonesterified fatty acids for energy. Little glycerol, which would normally be released from adipose tissue, is available for gluconeogenesis.

The Ability to Utilize Glucose May Be Ascertained by Measuring Glucose Tolerance

Glucose tolerance is the ability to regulate the blood glucose concentration after the administration of a test dose of glucose (normally 1 g/kg body weight) (**Figure 19–7**).

Diabetes mellitus (type 1, or insulin-dependent diabetes mellitus; IDDM) is characterized by decreased glucose tolerance as a result of decreased secretion of insulin because of progressive destruction of pancreatic β -islet cells. Glucose tolerance is also impaired in type 2 diabetes mellitus (non-insulin-dependent diabetes, NIDDM) as a result of impaired

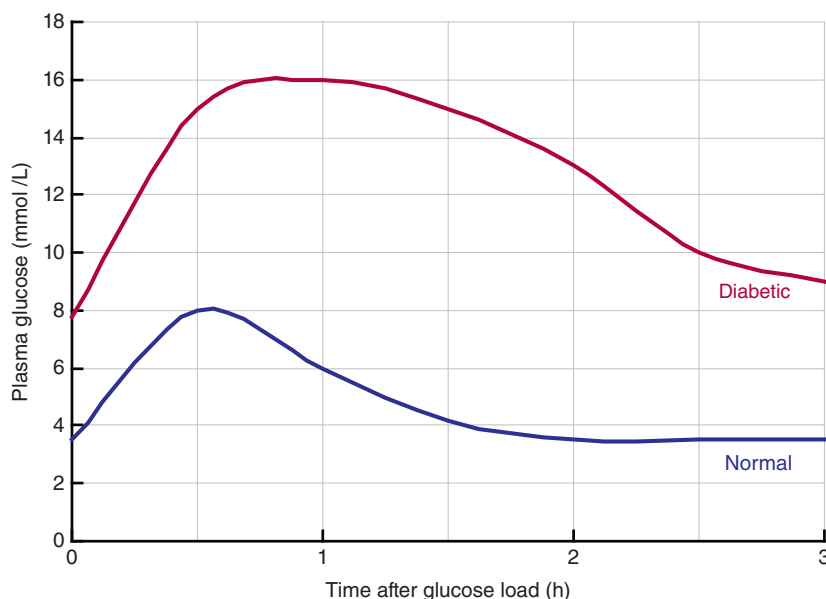

FIGURE 19–7 Glucose tolerance test. Blood glucose curves of a normal and a diabetic person after oral administration of 1 g of glucose/kg body weight. Note the initial raised concentration in the fasting diabetic. A criterion of normality is the return to the initial value within 2 hours.

sensitivity of tissues to insulin action. Insulin resistance associated with obesity (and especially abdominal obesity) leading to the development of hyperlipidemia, then atherosclerosis and coronary heart disease, as well as overt diabetes, is known as the **metabolic syndrome**. Impaired glucose tolerance also occurs in conditions where the liver is damaged, in some infections, and in response to some drugs, as well as in conditions that lead to hyperactivity of the pituitary gland or adrenal cortex because of the hormones secreted by these glands antagonize the action of insulin.

Administration of insulin (as in the treatment of diabetes mellitus) lowers the blood glucose concentration and increases its utilization and storage in the liver and muscle as glycogen. An excess of insulin may cause **hypoglycemia**, resulting in convulsions and even death unless glucose is administered promptly. Increased tolerance to glucose is observed in pituitary or adrenocortical insufficiency, attributable to a decrease in the antagonism to insulin by the hormones normally secreted by these glands.

The Energy Cost of Gluconeogenesis Explains Why Very Low Carbohydrate Diets Promote Weight Loss

Very low carbohydrate diets, providing only 20 g per day of carbohydrate or less (compared with a desirable intake of 100–120 g/day), but permitting unlimited consumption of fat and protein, have been promoted as an effective regime for weight loss, although such diets are counter to all advice on a prudent diet for health. Since there is a continual demand for glucose, there will be a considerable amount of gluconeogenesis from amino acids; the associated high ATP cost must then be met by oxidation of fatty acids.

SUMMARY

- Gluconeogenesis is the process of synthesizing glucose or glycogen from noncarbohydrate precursors. It is of particular importance when carbohydrate is not available from the diet. Significant substrates are amino acids, lactate, glycerol, and propionate.
- The pathway of gluconeogenesis in the liver and kidney utilizes those reactions in glycolysis that are reversible plus four additional reactions that circumvent the irreversible nonequilibrium reactions.
- Since glycolysis and gluconeogenesis share the same pathway but operate in opposite directions, their activities must be regulated reciprocally.
- The liver regulates the blood glucose concentration after a meal because it contains the high- K_m glucokinase that promotes increased hepatic utilization of glucose.
- Insulin is secreted as a direct response to hyperglycemia; it stimulates the liver to store glucose as glycogen and facilitates uptake of glucose into extrahepatic tissues.
- Glucagon is secreted as a response to hypoglycemia and activates both glycogenolysis and gluconeogenesis in the liver, causing release of glucose into the blood.

REFERENCES

- Barthel A, Schmoll D: Novel concepts in insulin regulation of hepatic gluconeogenesis. *Am J Physiol Endocrinol Metab* 2003;285:E685.
- Bijland S, Mancini SJ: Role of AMP-activated protein kinase in adipose tissue metabolism and inflammation. *Clin Sci (Lond)* 2013;124:491.
- Boden G: Gluconeogenesis and glycogenolysis in health and diabetes. *J Investig Med* 2004;52:375.
- Brealey D, Singer M: Hyperglycemia in critical illness: a review. *J Diabetes Sci Technol* 2009;3:1250.
- Brooks GA: Cell-cell and intracellular lactate shuttles. *J Physiol* 2009;587:5591.
- Dzugaj A: Localization and regulation of muscle fructose 1,6-bisphosphatase, the key enzyme of gluconeogenesis. *Adv Enzyme Regul* 2006;46:51.
- Hers HG, Hue L: Gluconeogenesis and related aspects of glycolysis. *Annu Rev Biochem* 1983;52:617.
- Jiang G, Zhang BB: Glucagon and regulation of glucose metabolism. *Am J Physiol Endocrinol Metab* 2003;284:E671.
- Jitrapakdee S, Vidal-Puig A, Wallace JC: Anaplerotic roles of pyruvate carboxylase in mammalian tissues. *Cell Mol Life Sci* 2006;63:843.
- Jitrapakdee S, St Maurice M, Rayment, et al: Structure, mechanism and regulation of pyruvate carboxylase. *Biochem J* 2008;413:369.
- Klover PJ, Mooney RA: Hepatocytes: critical for glucose homeostasis. *Int J Biochem Cell Biol* 2004;36:753.
- Lim CT, Kola B: AMPK as a mediator of hormonal signalling. *J Mol Endocrinol* 2010;44:87.
- Mather A, Pollock C: Glucose handling by the kidney. *Kidney Int Suppl* 2011;120:S1.
- McGuinness OP: Defective glucose homeostasis during infection. *Ann Rev Nutr* 2005;25:9.
- Mithieux G, Andreelli F, Magnan C: Intestinal gluconeogenesis: key signal of central control of energy and glucose homeostasis. *Curr Opin Clin Nutr Metab Care* 2009;12:419.
- Mlinar B, Marc J, Janez A, et al: Molecular mechanisms of insulin resistance and associated diseases. *Clin Chim Acta* 2007;375:20.
- Nordlie RC, Foster JD, Lange AJ: Regulation of glucose production by the liver. *Ann Rev Nutr* 1999;19:379.
- Pilkis SJ, Claus TH: Hepatic gluconeogenesis/glycolysis: regulation and structure/function relationships of substrate cycle enzymes. *Ann Rev Nutr* 1991;11:465.
- Pilkis SJ, Granner DK: Molecular physiology of the regulation of hepatic gluconeogenesis and glycolysis. *Ann Rev Physiol* 1992;54:885.
- Postic C, Shiota M, Magnuson MA: Cell-specific roles of glucokinase in glucose homeostasis. *Rec Prog Horm Res* 2001;56:195.
- Previs SF, Brunengraber DZ, Brunengraber H: Is there glucose production outside of the liver and kidney? *Ann Rev Nutr* 2009;29:43.
- Quinn PG, Yeagley D: Insulin regulation of PEPCK gene expression: a model for rapid and reversible modulation. *Curr Drug Targets Immune Endocr Metabol Disord* 2005;5:423.
- Ramnanan CJ, Edgerton DS: Physiologic action of glucagon on liver glucose metabolism. *Diabetes Obes Metab* 2011;13(suppl 1):118.

- Reaven GM: The insulin resistance syndrome: definition and dietary approaches to treatment. *Ann Rev Nutr* 2005;25:391.
- Roden M, Bernroider E: Hepatic glucose metabolism in humans—its role in health and disease. *Best Pract Res Clin Endocrinol Metab* 2003;17:365.
- Saggerson D: Malonyl-CoA, a key signaling molecule in mammalian cells. *Ann Rev Nutr* 2008;28:253.
- Schuit FC, Huypens P, Heimberg H, Pipeleers DG: Glucose sensing in pancreatic beta-cells: a model for the study of other glucose-regulated cells in gut, pancreas, and hypothalamus. *Diabetes* 2001;50:1.
- Suh SH, Paik IY, Jacobs K: Regulation of blood glucose homeostasis during prolonged exercise. *Mol Cells* 2007;23:272.
- Triplitt CL: Understanding the kidneys' role in blood glucose regulation. *Am J Manag Care* 2012;18:S11.
- Wahren J, Ekberg K: Splanchnic regulation of glucose production. *Ann Rev Nutr* 2007;27:329.
- Yabaluri N, Bashyam MD: Hormonal regulation of gluconeogenic gene transcription in the liver. *J Biosci* 2010;35:473.
- Young A: Inhibition of glucagon secretion. *Adv Pharmacol* 2005;52:151.

The Pentose Phosphate Pathway & Other Pathways of Hexose Metabolism

David A. Bender, PhD & Peter A. Mayes, PhD, DSc

OBJECTIVES

After studying this chapter, you should be able to:

- Describe the pentose phosphate pathway and its roles as a source of NADPH and in the synthesis of ribose for nucleotide synthesis.
- Describe the uronic acid pathway and its importance for synthesis of glucuronic acid for conjugation reactions and (in animals for which it is not a vitamin) vitamin C.
- Describe and explain the consequences of large intakes of fructose.
- Describe the synthesis and physiological importance of galactose.
- Explain the consequences of genetic defects of glucose-6-phosphate dehydrogenase deficiency (favism), the uronic acid pathway (essential pentosuria), and fructose and galactose metabolism.

BIOMEDICAL IMPORTANCE

The pentose phosphate pathway is an alternative route for the metabolism of glucose. It does not lead to formation of ATP but has two major functions: (1) the formation of **NADPH** for synthesis of fatty acids (see Chapter 23) and steroids (see Chapter 26), and maintaining reduced glutathione for antioxidant activity, and (2) the synthesis of **ribose** for nucleotide and nucleic acid formation (see Chapter 32). Glucose, fructose, and galactose are the main hexoses absorbed from the gastrointestinal tract, derived from dietary starch, sucrose, and lactose, respectively. Fructose and galactose can be converted to glucose, mainly in the liver.

Genetic deficiency of **glucose-6-phosphate dehydrogenase**, the first enzyme of the pentose phosphate pathway, causes of acute hemolysis of red blood cells, resulting in **hemolytic anemia**. Glucuronic acid is synthesized from glucose via the **uronic acid pathway**, of minor quantitative importance, but of major significance for the conjugation and excretion of metabolites and foreign chemicals (xenobiotics, Chapter 47) as **glucuronides**. A deficiency in the pathway leads to the condition of **essential pentosuria**. The lack of one enzyme of the pathway

(gulonolactone oxidase) in primates and some other animals explains why **ascorbic acid** (vitamin C, Chapter 44) is a dietary requirement for human beings but not most other mammals. Deficiencies in the enzymes of fructose and galactose metabolism lead to metabolic diseases such as **essential fructosuria**, **hereditary fructose intolerance**, and **galactosemia**.

THE PENTOSE PHOSPHATE PATHWAY FORMS NADPH & RIBOSE PHOSPHATE

The pentose phosphate pathway (hexose monophosphate shunt, **Figure 20-1**) is a more complex pathway than glycolysis (see Chapter 17). Three molecules of glucose-6-phosphate give rise to three molecules of CO₂ and three 5-carbon sugars. These are rearranged to regenerate two molecules of glucose-6-phosphate and one molecule of the glycolytic intermediate, glyceraldehyde-3-phosphate. Since two molecules of glyceraldehyde-3-phosphate can regenerate glucose-6-phosphate, the pathway can account for the complete oxidation of glucose.

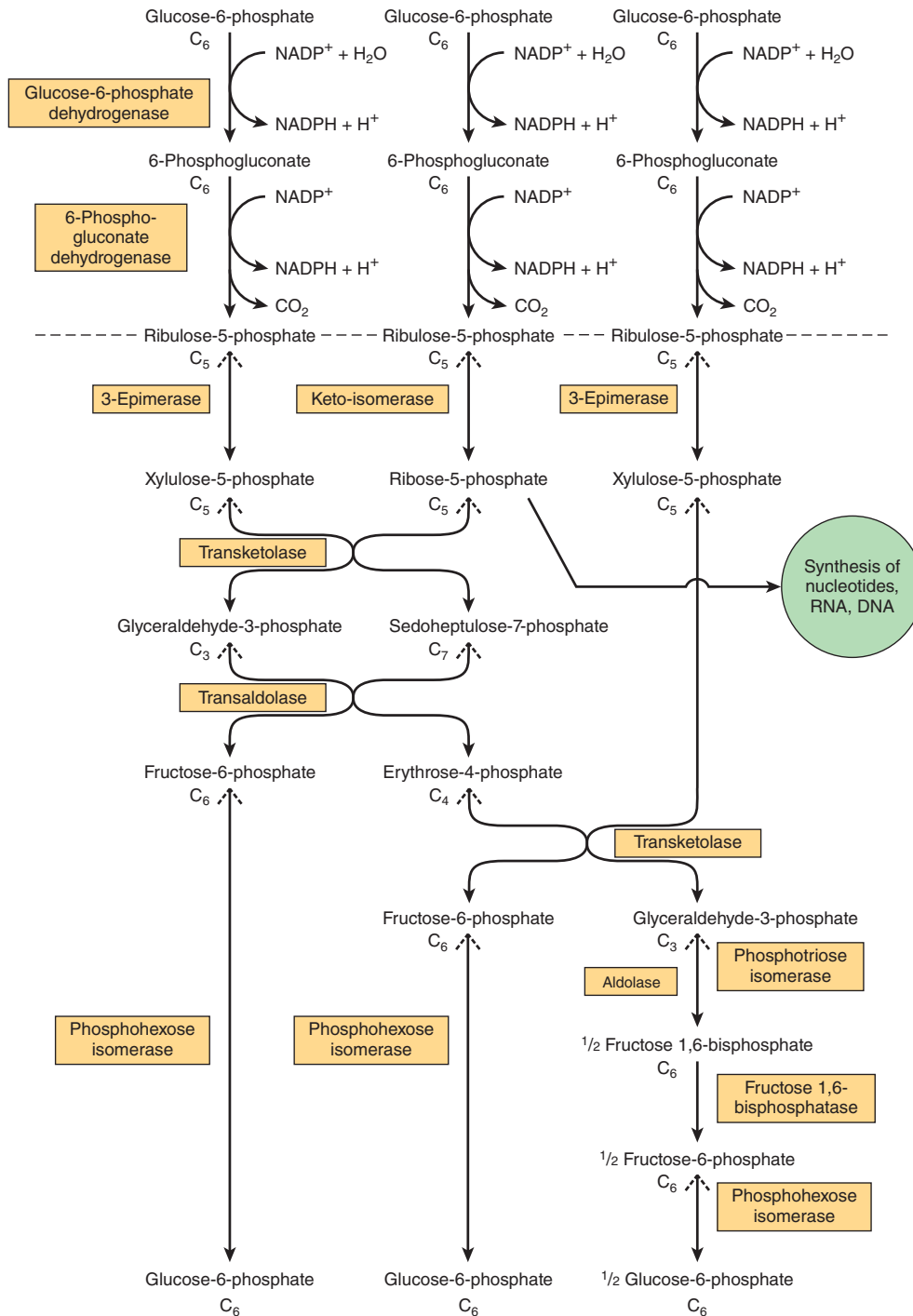

FIGURE 20-1 Flow chart of pentose phosphate pathway and its connections with the pathway of glycolysis. The full pathway, as indicated, consists of three interconnected cycles in which glucose-6-phosphate is both substrate and end product. The reactions above the broken line are nonreversible, whereas all reactions under that line are freely reversible apart from that catalyzed by fructose 1,6-bisphosphatase.

REACTIONS OF THE PENTOSE PHOSPHATE PATHWAY OCCUR IN THE CYTOSOL

Like glycolysis, the enzymes of the pentose phosphate pathway are cytosolic. Unlike glycolysis, oxidation is achieved by dehydrogenation using NADP^+ , not NAD^+ , as the hydrogen acceptor. The sequence of reactions of the pathway may be divided into two phases: an **irreversible oxidative phase** and a **reversible nonoxidative phase**. In the first phase, glucose-6-phosphate undergoes dehydrogenation and decarboxylation to yield a pentose, ribulose-5-phosphate. In the second phase, ribulose-5-phosphate is converted back to glucose-6-phosphate by a series of reactions involving mainly two enzymes: **transketolase** and **transaldolase** (see Figure 20–1).

The Oxidative Phase Generates NADPH

Dehydrogenation of glucose-6-phosphate to 6-phosphogluconate occurs via the formation of 6-phosphogluconolactone, catalyzed by **glucose 6-phosphate dehydrogenase**, an NADP-dependent enzyme (Figures 20–1 and 20–2). The hydrolysis of 6-phosphogluconolactone is accomplished by the enzyme **gluconolactone hydrolase**. A second oxidative step is catalyzed by **6-phosphogluconate dehydrogenase**, which also requires NADP^+ as hydrogen acceptor. Decarboxylation follows with the formation of the ketopentose ribulose-5-phosphate.

In the endoplasmic reticulum, an isoenzyme of glucose-6-phosphate dehydrogenase, hexose-6-phosphate dehydrogenase, provides NADPH for hydroxylation (mixed function oxidase) reactions, and also for 11- β -hydroxysteroid dehydrogenase-1. This enzyme catalyzes the reduction of (inactive) cortisone to (active) cortisol in liver, the nervous system, and adipose tissue. It is the major source of intracellular cortisol in these tissues and may be important in obesity and the metabolic syndrome.

The Nonoxidative Phase Generates Ribose Precursors

Ribulose-5-phosphate is the substrate for two enzymes. **Ribulose-5-phosphate 3-epimerase** alters the configuration about carbon 3, forming the epimer xylulose 5-phosphate, also a ketopentose. **Ribulose-5-phosphate ketoisomerase** converts ribulose 5-phosphate to the corresponding aldopentose, ribose-5-phosphate, which is used for nucleotide and nucleic acid synthesis. **Transketolase** transfers the two-carbon unit comprising carbons 1 and 2 of a ketose onto the aldehyde carbon of an aldose sugar. It therefore effects the conversion of a ketose sugar into an aldose with two carbons less and an aldose sugar into a ketose with two carbons more. The reaction requires Mg^{2+} and **thiamin diphosphate** (vitamin B_1) as coenzyme. Measurement of erythrocyte transketolase and its activation by thiamin diphosphate provides an index of vitamin B_1 nutritional status (see Chapter 44). The two-carbon moiety transferred is probably glycolaldehyde bound to thiamin diphosphate. Thus, transketolase catalyzes the transfer of the two-carbon unit from

xylulose-5-phosphate to ribose-5-phosphate, producing the seven-carbon ketose sedoheptulose-7-phosphate and the aldose glyceraldehyde-3-phosphate. These two products then undergo transaldolation. **Transaldolase** catalyzes the transfer of a three-carbon dihydroxyacetone moiety (carbons 1–3) from the ketose sedoheptulose-7-phosphate onto the aldose glyceraldehyde-3-phosphate to form the ketose fructose 6-phosphate and the four-carbon aldose erythrose 4-phosphate. Transaldolase has no cofactor, and the reaction proceeds via the intermediate formation of a Schiff base of dihydroxyacetone to the ϵ -amino group of a lysine residue in the enzyme. In a further reaction catalyzed by **transketolase**, xylulose-5-phosphate serves as a donor of glycolaldehyde. In this case, erythrose-4-phosphate is the acceptor, and the products of the reaction are fructose-6-phosphate and glyceraldehyde-3-phosphate.

In order to oxidize glucose completely to CO_2 via the pentose phosphate pathway, there must be enzymes present in the tissue to convert glyceraldehyde-3-phosphate to glucose-6-phosphate. This involves reversal of glycolysis and the gluconeogenic enzyme **fructose 1,6-bisphosphatase**. In tissues that lack this enzyme, glyceraldehyde-3-phosphate follows the normal pathway of glycolysis to pyruvate.

The Two Major Pathways for the Catabolism of Glucose Have Little in Common

Although glucose-6-phosphate is common to both pathways, the pentose phosphate pathway is markedly different from glycolysis. Oxidation utilizes NADP^+ rather than NAD^+ , and CO_2 , which is not produced in glycolysis, is a characteristic product. No ATP is generated in the pentose phosphate pathway, whereas it is a product of glycolysis.

The two pathways are, however, connected. Xylulose 5-phosphate activates the protein phosphatase that dephosphorylates the 6-phosphofructo-2-kinase/fructose 2,6-bisphosphatase bifunctional enzyme (see Chapter 17). This activates the kinase and inactivates the phosphatase, leading to increased formation of fructose 2,6-bisphosphate, increased activity of phosphofructokinase-1, and hence increased glycolytic flux. Xylulose-5-phosphate also activates the protein phosphatase that initiates the nuclear translocation and DNA binding of the carbohydrate response element binding protein, leading to increased synthesis of fatty acids (see Chapter 23) in response to a high carbohydrate diet.

Reducing Equivalents Are Generated in Those Tissues Specializing in Reductive Syntheses

The pentose phosphate pathway is active in liver, adipose tissue, adrenal cortex, thyroid, erythrocytes, testis, and lactating mammary gland. Its activity is low in nonlactating mammary gland and skeletal muscle. Those tissues in which the pathway is active use NADPH in reductive syntheses, for example, of fatty acids, steroids, amino acids via glutamate

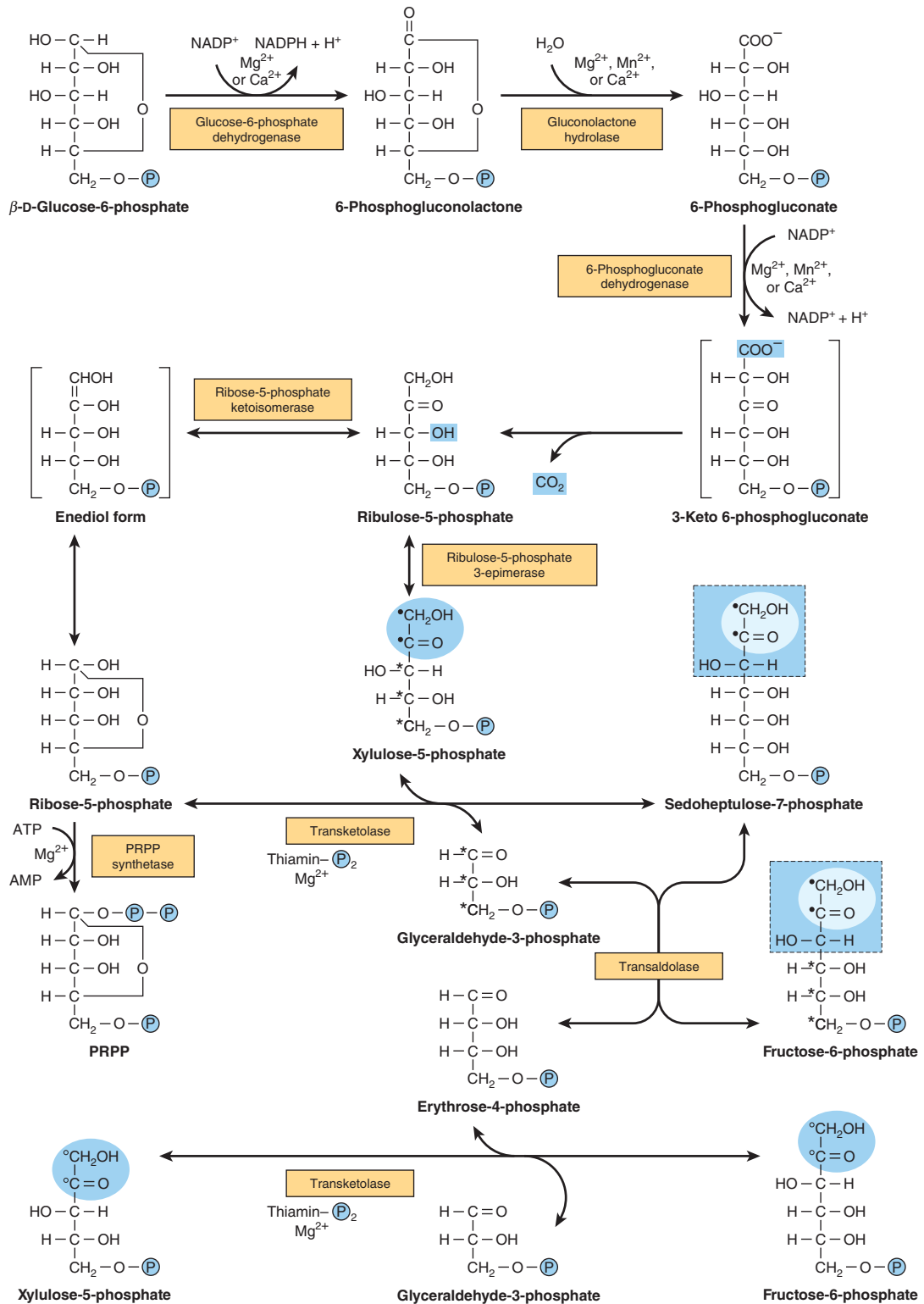

FIGURE 20-2 The pentose phosphate pathway. (P, $-\text{PO}_3^{2-}$; PRPP, 5-phosphoribosyl 1-pyrophosphate.)

dehydrogenase, and reduced glutathione. The synthesis of glucose-6-phosphate dehydrogenase and 6-phosphogluconate dehydrogenase may also be induced by insulin in the fed state, when lipogenesis increases.

Ribose Can Be Synthesized in Virtually All Tissues

Little or no ribose circulates in the bloodstream, so tissues have to synthesize the ribose they require for nucleotide and nucleic acid synthesis using the pentose phosphate pathway (see Figure 20–2). It is not necessary to have a completely functioning pentose phosphate pathway for a tissue to synthesize ribose 5-phosphate. Muscle has only low activity of glucose-6-phosphate dehydrogenase and 6-phosphogluconate dehydrogenase, but, like most other tissues, it is capable of synthesizing ribose-5-phosphate by reversal of the nonoxidative phase of the pentose phosphate pathway utilizing fructose-6-phosphate.

THE PENTOSE PHOSPHATE PATHWAY & GLUTATHIONE PEROXIDASE PROTECT ERYTHROCYTES AGAINST HEMOLYSIS

In red blood cells, the pentose phosphate pathway is the sole source of NADPH for the reduction of oxidized glutathione catalyzed by **glutathione reductase**, a flavoprotein containing FAD. Reduced glutathione removes H_2O_2 in a reaction catalyzed by **glutathione peroxidase**, an enzyme that contains the **selenium** analog of cysteine (selenocysteine) at the active site (Figure 20–3). The reaction is important since accumulation of H_2O_2 may decrease the life span of the erythrocyte by causing oxidative damage to the cell membrane, leading to hemolysis. In other tissues, NADPH can also be generated by the reaction catalyzed by the malic enzyme.

GLUCURONATE, A PRECURSOR OF PROTEOGLYCAN & CONJUGATED GLUCURONIDES, IS A PRODUCT OF THE URONIC ACID PATHWAY

In liver, the **uronic acid pathway** catalyzes the conversion of glucose to glucuronic acid, ascorbic acid (except in human beings and other species for which ascorbate is a vitamin, vitamin C), and pentoses (Figure 20–4). It is also an alternative oxidative pathway for glucose that, like the pentose phosphate pathway, does not lead to the formation of ATP. Glucose-6-phosphate is isomerized to glucose-1-phosphate, which then reacts with uridine triphosphate (UTP) to form uridine diphosphate glucose (UDPGlc) in a reaction catalyzed by **UDPGlc pyrophosphorylase**, as occurs in glycogen synthesis (Chapter 18). UDPGlc is oxidized at carbon 6 by NAD-dependent **UDPGlc dehydrogenase** in a two-step reaction to yield UDP-glucuronate.

UDP-glucuronate is the source of glucuronate for reactions involving its incorporation into proteoglycans (see Chapter 46) or for reaction with substrates such as steroid hormones, bilirubin, and a number of drugs that are excreted in urine or bile as glucuronide conjugates (see Figure 31–13 and Chapter 47).

Glucuronate is reduced to **L-gulonate**, the direct precursor of **ascorbate** in those animals capable of synthesizing this vitamin, in an NADPH-dependent reaction. In human beings and other primates, as well as guinea pigs, bats, and some birds and fishes, ascorbic acid cannot be synthesized because of the absence of **L-gulonolactone oxidase**. L-Gulonate is oxidized to 3-keto-L-gulonate, which is then decarboxylated to L-xylulose. L-Xylulose is converted to the D isomer by an NADPH-dependent reduction to xylitol, followed by oxidation in an NAD-dependent reaction to D-xylulose. After conversion to D-xylulose 5-phosphate, it is metabolized via the pentose phosphate pathway.

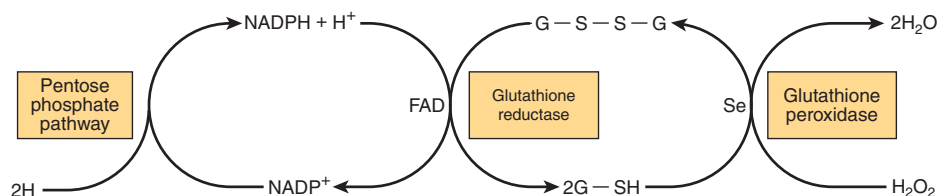

FIGURE 20–3 Role of the pentose phosphate pathway in the glutathione peroxidase reaction of erythrocytes. (G-SH, reduced glutathione; G-S-S-G, oxidized glutathione; Se, selenium-containing enzyme.)

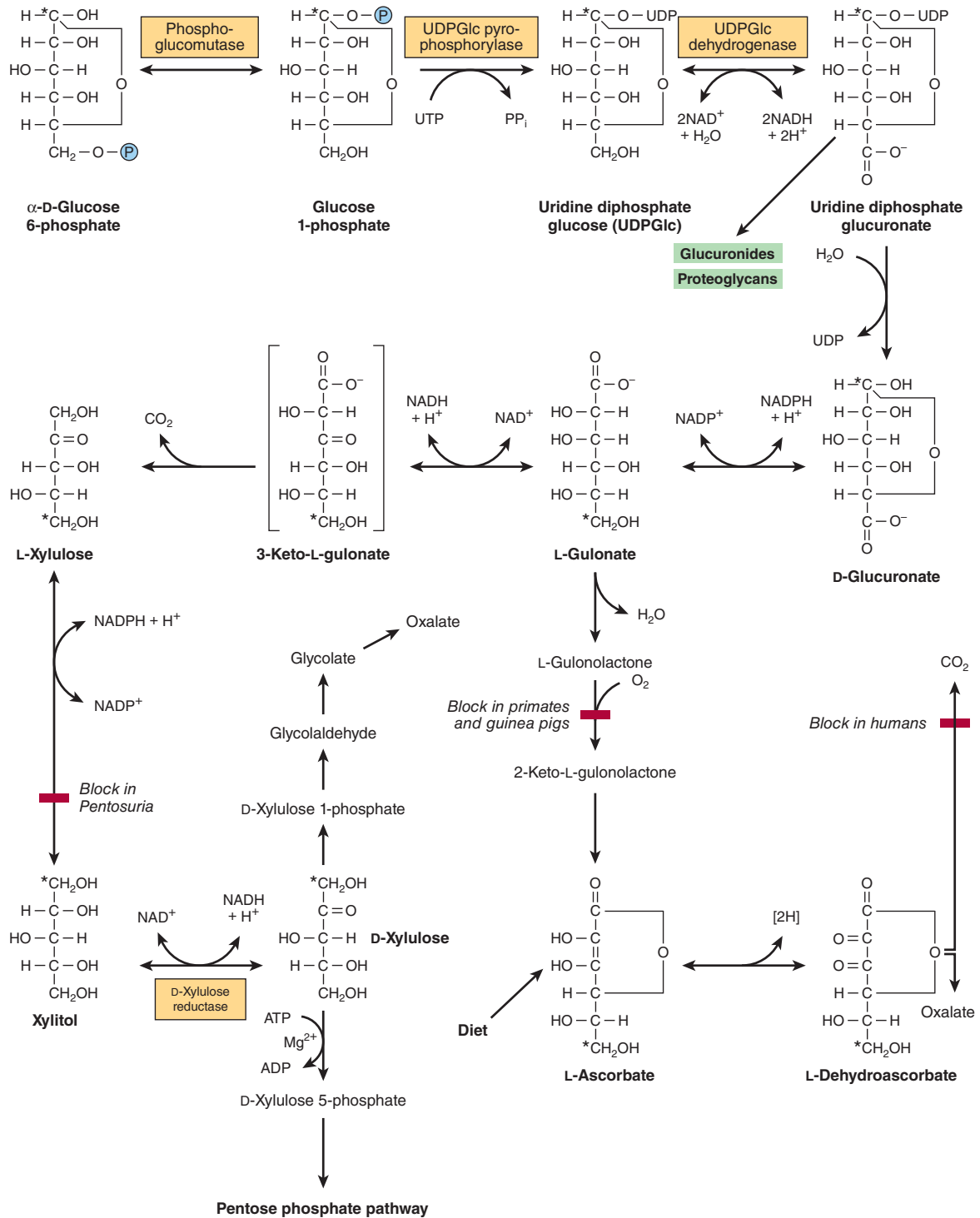

FIGURE 20-4 Uronic acid pathway. (*Indicates the fate of carbon 1 of glucose; $-PO_3^{2-}$.)

INGESTION OF LARGE QUANTITIES OF FRUCTOSE HAS PROFOUND METABOLIC CONSEQUENCES

Diets high in sucrose or in high-fructose syrups (HFS) used in manufactured foods and beverages lead to large amounts of fructose (and glucose) entering the hepatic portal vein.

Fructose undergoes more rapid glycolysis in the liver than does glucose because it bypasses the regulatory step catalyzed by phosphofructokinase (Figure 20–5). This allows fructose to flood the pathways in the liver, leading to increased fatty acid synthesis, esterification of fatty acids, and secretion of VLDL, which may raise serum triacylglycerols and ultimately

raise LDL cholesterol concentrations. **Fructokinase** in liver, kidney, and intestine, catalyzes the phosphorylation of fructose to fructose-1-phosphate. This enzyme does not act on glucose, and, unlike glucokinase, its activity is not affected by fasting or by insulin, which may explain why fructose is cleared from the blood of diabetic patients at a normal rate. Fructose-1-phosphate is cleaved to D-glyceraldehyde and dihydroxyacetone phosphate by **aldolase B**, an enzyme found in the liver, which also functions in glycolysis in the liver by cleaving fructose 1,6-bisphosphate. D-Glyceraldehyde enters glycolysis via phosphorylation to glyceraldehyde-3-phosphate catalyzed by **triokinase**. The two triose phosphates, dihydroxyacetone phosphate, and glyceraldehyde-3-phosphate, may either be degraded by glycolysis or may be substrates for aldolase and hence gluconeogenesis, which is the fate of much of the fructose metabolized in the liver.

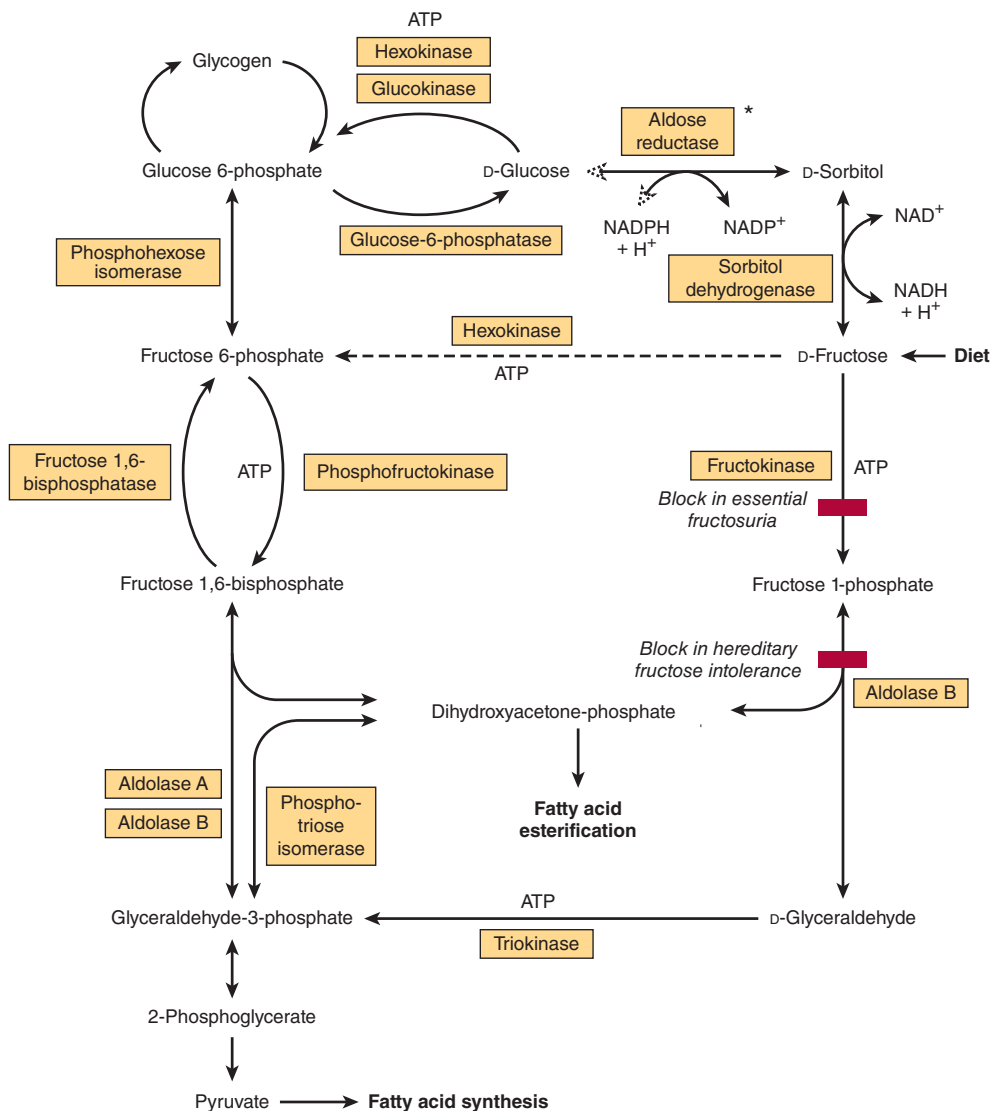

FIGURE 20–5 Metabolism of fructose. Aldolase A is found in all tissues, whereas aldolase B is the predominant form in liver. (*Not found in liver.)

In extrahepatic tissues, hexokinase catalyzes the phosphorylation of most hexose sugars, including fructose, but glucose inhibits the phosphorylation of fructose since it is a better substrate for hexokinase. Nevertheless, some fructose can be metabolized in adipose tissue and muscle. Fructose is found in seminal plasma and in the fetal circulation of ungulates and whales. Aldose reductase is found in the placenta of the ewe and is responsible for the secretion of sorbitol into the fetal blood. The presence of sorbitol dehydrogenase in the liver, including the fetal liver, is responsible for the conversion of sorbitol into fructose. This pathway is also responsible for the occurrence of fructose in seminal fluid.

GALACTOSE IS NEEDED FOR THE SYNTHESIS OF LACTOSE, GLYCOLIPIDS, PROTEOGLYCANS, & GLYCOPROTEINS

Galactose is derived from intestinal hydrolysis of the disaccharide **lactose**, the sugar found in milk. It is readily converted in the liver to glucose. **Galactokinase** catalyzes the phosphorylation of galactose, using ATP as phosphate donor (**Figure 20–6**). Galactose 1-phosphate reacts with UDPGlc to form uridine diphosphate galactose (UDPGal) and glucose 1-phosphate, in a reaction catalyzed by **galactose-1-phosphate**

uridyl transferase. The conversion of UDPGal to UDPGlc is catalyzed by **UDPGlc 4-epimerase**. The reaction involves oxidation, and then reduction, at carbon 4, with NAD^+ as a coenzyme. The UDPGlc is then incorporated into glycogen (see Chapter 18).

The epimerase reaction is freely reversible, so glucose can be converted to galactose, and galactose is not a dietary essential. Galactose is required in the body not only for the formation of lactose in lactation, but also as a constituent of glycolipids (cerebrosides), proteoglycans, and glycoproteins. In the synthesis of lactose in the mammary gland, UDPGal condenses with glucose to yield lactose, catalyzed by **lactose synthase** (see Figure 20–6).

Glucose Is the Precursor of Amino Sugars (Hexosamines)

Amino sugars are important components of **glycoproteins** (see Chapter 46), of certain **glycosphingolipids** (eg, gangliosides; Chapter 21), and of glycosaminoglycans (see Chapter 50). The major amino sugars are the hexosamines **glucosamine**, **galactosamine**, and **mannosamine**, and the nine-carbon compound **sialic acid**. The principal sialic acid found in human tissues is *N*-acetylneuraminic acid (NeuAc). A summary of the metabolic interrelationships among the amino sugars is shown in **Figure 20–7**.

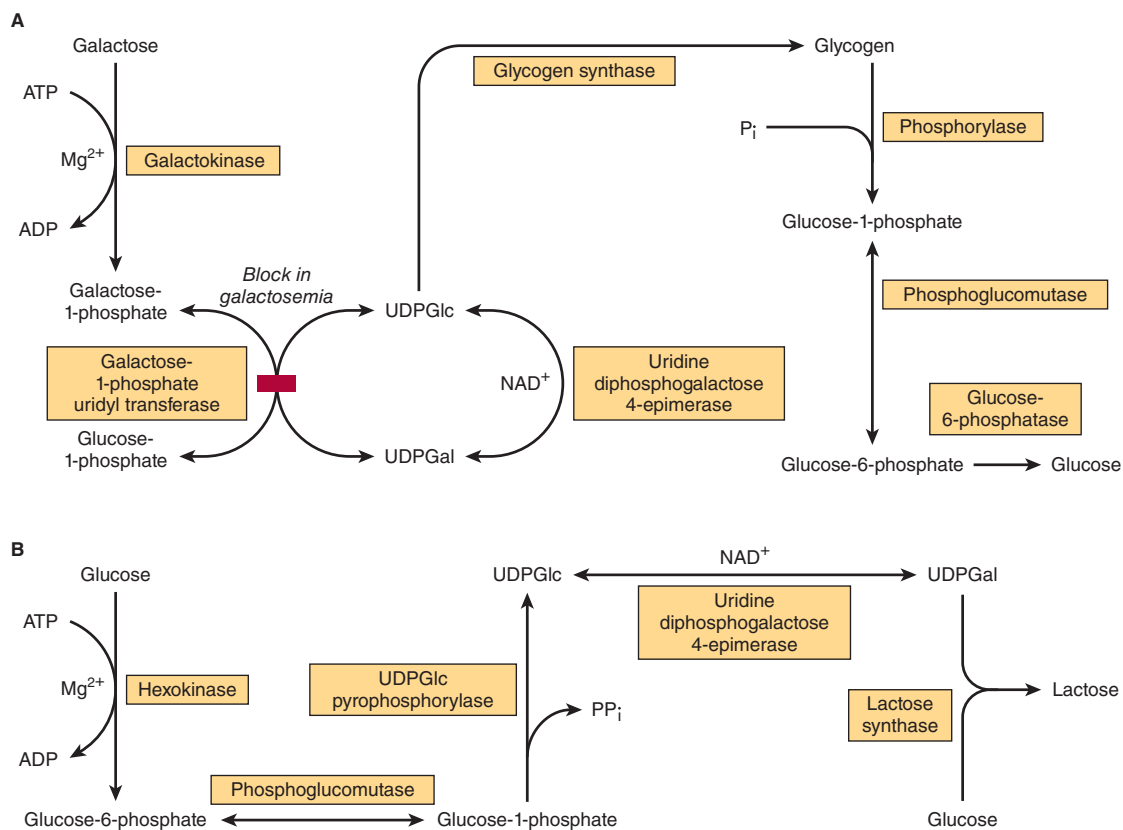

FIGURE 20–6 Pathway of conversion of (A) galactose to glucose in the liver and (B) glucose to lactose in the lactating mammary gland.

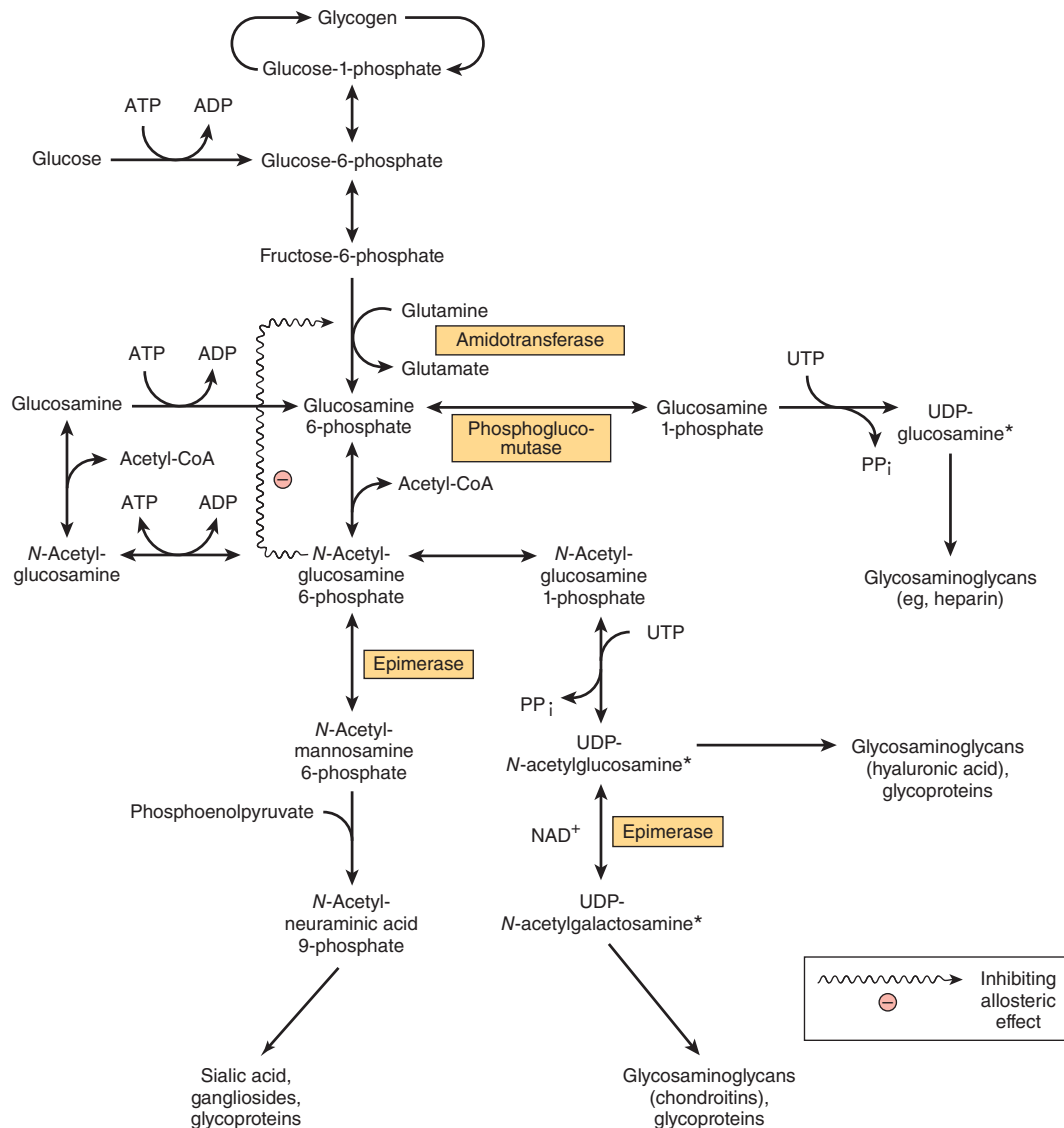

FIGURE 20-7 Summary of the interrelationships in metabolism of amino sugars. (*Analogous to UDPGlc.) Other purine or pyrimidine nucleotides may be similarly linked to sugars or amino sugars. Examples are thymidine diphosphate (TDP)-glucosamine and TDP-*N*-acetylglucosamine.

CLINICAL ASPECTS

Impairment of the Pentose Phosphate Pathway Leads to Erythrocyte Hemolysis

Genetic defects of glucose-6-phosphate dehydrogenase, with consequent impairment of the generation of NADPH, are common in populations of Mediterranean and Afro-Caribbean origin. The gene is on the X chromosome, so it is mainly males who are affected. Some 400 million people carry a mutated gene for glucose-6-phosphate dehydrogenase, making it the most common genetic defect, but most are asymptomatic. In some populations, glucose-6-phosphatase deficiency is common enough for it to be regarded as a genetic polymorphism. The distribution

of mutant genes parallels that of malaria, suggesting that being heterozygous confers resistance against malaria. The defect is manifested as red cell hemolysis (**hemolytic anemia**) when susceptible individuals are subjected to oxidative stress (see Chapter 45) from infection, drugs such as the antimalarial primaquine, and sulfonamides, or when they have eaten fava beans (*Vicia faba*—hence the name of the disease, **favism**).

Many different mutations are known in the gene for glucose-6-phosphate dehydrogenase, leading to two main variants of favism. In the Afro-Caribbean variant the enzyme is unstable, so that while average red-cell activities are low, it is only the older erythrocytes that are affected by oxidative stress, and the hemolytic crises tend to be self-limiting. By contrast, in the Mediterranean variant the enzyme is stable,

but has low activity in all erythrocytes. Hemolytic crises in these people are more severe and can be fatal. Glutathione peroxidase is dependent upon a supply of NADPH, which in erythrocytes can only be formed via the pentose phosphate pathway. It reduces organic peroxides and H_2O_2 , as part of the body's defense against lipid peroxidation. Measurement of erythrocyte **glutathione reductase**, and its activation by FAD is used to assess **vitamin B₂** nutritional status (see Chapter 44).

Disruption of the Uronic Acid Pathway Is Caused by Enzyme Defects & Some Drugs

In the rare benign hereditary condition **essential pentosuria**, considerable quantities of **xylulose** appear in the urine, because of a lack of xylulose reductase, the enzyme necessary to reduce xylulose to xylitol. Although pentosuria is benign, with no clinical consequences, xylulose is a reducing sugar and can give false positive results when urinary glucose is measured using alkaline copper reagents (see Chapter 48). Various drugs increase the rate at which glucose enters the uronic acid pathway. For example, administration of barbital or chlorobutanol to rats results in a significant increase in the conversion of glucose to glucuronate, L-gulonate, and ascorbate. Aminopyrine and antipyrine increase the excretion of xylulose in pentosuric subjects. Pentosuria also occurs after consumption of relatively large amounts of fruits such as pears that are rich sources of pentoses (**alimentary pentosuria**).

Loading of the Liver With Fructose May Potentiate Hypertriacylglycerolemia, Hypercholesterolemia, & Hyperuricemia

In the liver, fructose increases fatty acid and triacylglycerol synthesis and VLDL secretion, leading to hypertriacylglycerolemia—and increased LDL cholesterol—which can be regarded as potentially atherogenic (see Chapter 26). This is because fructose enters glycolysis via fructokinase, and the resulting fructose 1-phosphate bypasses the regulatory step catalyzed by phosphofructokinase (see Chapter 17). In addition, acute loading of the liver with fructose, as can occur with intravenous infusion or following very high fructose intakes, causes sequestration of inorganic phosphate in fructose-1-phosphate and diminished ATP synthesis. As a result, there is less inhibition of de novo purine synthesis by ATP, and uric acid formation is increased, causing hyperuricemia, which is the cause of **gout** (see Chapter 33). Since fructose is absorbed from the small intestine by (passive) carrier-mediated diffusion, high oral doses may lead to osmotic diarrhea.

Defects in Fructose Metabolism Cause Disease

A lack of hepatic fructokinase causes **essential fructosuria**, which is a benign and asymptomatic condition. The absence of

aldolase B, which cleaves fructose-1-phosphate, leads to **hereditary fructose intolerance**, which is characterized by profound hypoglycemia and vomiting after consumption of fructose (or sucrose, which yields fructose on digestion). Diets low in fructose, sorbitol, and sucrose are beneficial for both conditions. One consequence of hereditary fructose intolerance and of a related condition as a result of **fructose 1,6-bisphosphatase deficiency** is fructose-induced **hypoglycemia** despite the presence of high glycogen reserves, because fructose-1-phosphate and 1,6-bisphosphate allosterically inhibit liver glycogen phosphorylase. The sequestration of inorganic phosphate also leads to depletion of ATP and hyperuricemia.

Fructose & Sorbitol in the Lens Are Associated With Diabetic Cataract

Both fructose and sorbitol are found in the lens of the eye in increased concentrations in diabetes mellitus and may be involved in the pathogenesis of **diabetic cataract**. The **sorbitol (polyol) pathway** (not found in liver) is responsible for fructose formation from glucose (see Figure 20–5) and increases in activity as the glucose concentration rises in those tissues that are not insulin-sensitive—the lens, peripheral nerves, and renal glomeruli. Glucose is reduced to sorbitol by **aldose reductase**, followed by oxidation of sorbitol to fructose in the presence of NAD^+ and sorbitol dehydrogenase (polyol dehydrogenase). Sorbitol does not diffuse through cell membranes, but accumulates, causing osmotic damage. Simultaneously, myoinositol levels fall. In experimental animals, sorbitol accumulation and myoinositol depletion, as well as diabetic cataract, can be prevented by aldose reductase inhibitors. One inhibitor has been licensed in Japan for treatment of diabetic neuropathy, although there is little or no evidence that inhibitors are effective in preventing cataract or slowing the progression of diabetic neuropathy in human beings.

Enzyme Deficiencies in the Galactose Pathway Cause Galactosemia

Inability to metabolize galactose occurs in the **galactosemias**, which may be caused by inherited defects of galactokinase, uridyl transferase, or 4-epimerase (Figure 20–6A), though deficiency of **uridyl transferase** is best known. Galactose is a substrate for aldose reductase, forming galactitol, which accumulates in the lens of the eye, causing cataract. The condition is more severe if it is the result of a defect in the uridyl transferase since galactose-1-phosphate accumulates and depletes the liver of inorganic phosphate. Ultimately, liver failure and mental deterioration result. In uridyl transferase deficiency, the epimerase is present in adequate amounts, so that the galactosemic individual can still form UDPGal from glucose. This explains how it is possible for normal growth and development of affected children to occur despite the galactose-free diets used to control the symptoms of the disease.

SUMMARY

- The pentose phosphate pathway, present in the cytosol, can account for the complete oxidation of glucose, producing NADPH and CO₂ but not ATP.
- The pathway has an oxidative phase, which is irreversible and generates NADPH, and a nonoxidative phase, which is reversible and provides ribose precursors for nucleotide synthesis. The complete pathway is present mainly in those tissues having a requirement for NADPH for reductive syntheses, eg, lipogenesis or steroidogenesis, whereas the nonoxidative phase is present in all cells requiring ribose.
- In erythrocytes, the pathway has a major function in preventing hemolysis by providing NADPH to maintain glutathione in the reduced state as the substrate for glutathione peroxidase.
- The uronic acid pathway is the source of glucuronic acid for conjugation of many endogenous and exogenous substances before excretion as glucuronides in urine and bile.
- Fructose bypasses the main regulatory step in glycolysis, catalyzed by phosphofructokinase, and stimulates fatty acid synthesis and hepatic triacylglycerol secretion.
- Galactose is synthesized from glucose in the lactating mammary gland and in other tissues where it is required for the synthesis of glycolipids, proteoglycans, and glycoproteins.

REFERENCES

Ali M, Rellos P, Cox TM: Hereditary fructose intolerance. *J Med Gen* 1998;35:353.

- Cappellini MD, Fiorelli G: Glucose 6-phosphate dehydrogenase deficiency. *Lancet* 2008;371:64.
- Dunlop M: Aldose reductase and the role of the polyol pathway in diabetic nephropathy. *Kidney Int* 2000;77:S3.
- Grant CM: Metabolic reconfiguration is a regulated response to oxidative stress. *J Biol* 2008;7:1.
- Ho HY, Cheng ML: Glucose-6-phosphate dehydrogenase—from oxidative stress to cellular functions and degenerative diseases. *Redox Rep* 2007;12:109.
- Horecker BL: The pentose phosphate pathway. *J Biol Chem* 2002;277:47965.
- Le KA, Tappy L: Metabolic effects of fructose. *Curr Opin Clin Nutr Metab Care* 2006;9:469.
- Leslie ND: Insights into the pathogenesis of galactosemia. *Ann Rev Nutr* 2003;23:59.
- Manganelli G, Fico A, Martini G, et al: Discussion on pharmacogenetic interaction in G6PD deficiency and methods to identify potential hemolytic drugs. *Cardiovasc Hematol Disord Drug Targets* 2010;10:143.
- Mayes PA: Intermediary metabolism of fructose. *Amer J Clin Nutr* 1993;58:754.
- Van den Berghe G: Inborn errors of fructose metabolism. *Ann Rev Nutr* 1994;14:41.
- Veech RL: A humble hexose monophosphate pathway metabolite regulates short- and long-term control of lipogenesis. *Proc Natl Acad Sci USA* 2003;100:5578.
- Wamelink MM, Struys EA, Jakobs C: The biochemistry, metabolism and inherited defects of the pentose phosphate pathway: a review. *J Inherit Metab Dis* 2008;31:703.
- Wong D: Hereditary fructose intolerance. *Mol Genet Metab* 2005;85:165.

Exam Questions

Section IV – Metabolism of Carbohydrates

- Which of the following is a definition of glycemic index?
 - The decrease in the blood concentration of glucagon after consuming the food compared with an equivalent amount of white bread.
 - The increase in the blood concentration of glucose after consuming the food.
 - The increase in the blood concentration of glucose after consuming the food compared with an equivalent amount of white bread.
 - The increase in the blood concentration of insulin after consuming the food.
 - The increase in the blood concentration of insulin after consuming the food compared with an equivalent amount of white bread.
- Which of the following will have the lowest glycemic index?
 - A baked apple
 - A baked potato
 - An uncooked apple
 - An uncooked potato
 - Apple juice
- Which of the following will have the highest glycaemic index?
 - A baked apple
 - A baked potato
 - An uncooked apple
 - An uncooked potato
 - Apple juice
- A blood sample is taken from a 50-year-old woman after an overnight fast. Which one of the following will be at a higher concentration than after she had eaten a meal?
 - Glucose
 - Insulin
 - Ketone bodies
 - Nonesterified fatty acids
 - Triacylglycerol
- A blood sample is taken from a 25-year-old man after he has eaten three slices of toast and a boiled egg. Which one of the following will be at a higher concentration than if the blood sample had been taken after an overnight fast?
 - Alanine
 - Glucagon
 - Glucose
 - Ketone bodies
 - Nonesterified fatty acids
- A blood sample is taken from a 40-year-old man has been fasting completely for a week, drinking only water. Which of the following will be at a higher concentration than after a normal overnight fast?
 - Glucose
 - Insulin
 - Ketone bodies
 - Nonesterified fatty acids
 - Triacylglycerol
- Which one of following statements about the fed and fasting metabolic states is correct?
 - In the fasting state glucagon acts to increase the activity of lipoprotein lipase in adipose tissue.
 - In the fasting state, glucagon acts to increase the synthesis of glycogen from glucose.
 - In the fed state insulin acts to increase the breakdown of glycogen to maintain blood glucose.
 - In the fed state there is decreased secretion of insulin in response to increased glucose in the portal blood.
 - Ketone bodies are synthesized in liver in the fasting state, and the amount synthesized increases as fasting extends into starvation.
- Which one of following statements about the fed and fasting metabolic states is correct?
 - In the fed state muscle can take up glucose for use as a metabolic fuel because glucose transport in muscle is stimulated in response to glucagon.
 - In the fed state there is decreased secretion of glucagon in response to increased glucose in the portal blood.
 - In the fed state, glucagon acts to increase the synthesis of glycogen from glucose.
 - Plasma glucose is maintained in starvation and prolonged fasting by gluconeogenesis from ketone bodies.
 - There is an increase in metabolic rate in the fasting state.
- Which one of following statements about the fed and fasting metabolic states is correct?
 - In the fasting state muscle synthesizes glucose from amino acids.
 - In the fed state adipose tissue can take up glucose for synthesis of triacylglycerol because glucose transport in adipose tissue is stimulated in response to glucagon.
 - Ketone bodies are synthesized in muscle in the fasting state, and the amount synthesized increases as fasting extends into starvation.
 - Ketone bodies provide an alternative fuel for red blood cells in the fasting state.
 - Plasma glucose is maintained in starvation and prolonged fasting by gluconeogenesis from fatty acids.
- Which one of following statements about the fed and fasting metabolic states is correct?
 - In the fasting state adipose tissue synthesizes glucose from the glycerol released by the breakdown of triacylglycerol.
 - In the fasting state adipose tissue synthesizes ketone bodies.
 - In the fasting state the main fuel for red blood cells is fatty acids released from adipose tissue.
 - Ketone bodies provide the main fuel for the central nervous system in the fasting state.
 - Plasma glucose is maintained in starvation and prolonged fasting by gluconeogenesis in the liver from the amino acids released by the breakdown of muscle protein.

11. Which one of following statements about the fed and fasting metabolic states is correct?
- Fatty acids and triacylglycerol are synthesized in the liver in the fasting state.
 - In the fasting state the main fuel for the central nervous system is fatty acids released from adipose tissue.
 - In the fasting state the main metabolic fuel for most tissues comes from fatty acids released from adipose tissue.
 - In the fed state muscle cannot take up glucose for use as a metabolic fuel because glucose transport in muscle is stimulated in response to glucagon.
 - Plasma glucose is maintained in starvation and prolonged fasting by gluconeogenesis in adipose tissue from the glycerol released from triacylglycerol.
12. A 25-year-old man visits his GP complaining of abdominal cramps and diarrhea after drinking milk. What is the most likely cause of his problem?
- Bacterial and yeast overgrowth in the large intestine
 - Infection with the intestinal parasite *Giardia lamblia*
 - Lack of pancreatic amylase
 - Lack of small intestinal lactase
 - Lack of small intestinal sucrase-isomaltase
13. Which one of following statements about glycolysis and gluconeogenesis is correct?
- All the reactions of glycolysis are freely reversible for gluconeogenesis.
 - Fructose cannot be used for gluconeogenesis in the liver because it cannot be phosphorylated to fructose-6-phosphate.
 - Glycolysis can proceed in the absence of oxygen only if pyruvate is formed from lactate in muscle.
 - Red blood cells only metabolize glucose by anaerobic glycolysis (and the pentose phosphate pathway).
 - The reverse of glycolysis is the pathway for gluconeogenesis in skeletal muscle.
14. Which one of following statements about the step in glycolysis catalyzed by hexokinase and in gluconeogenesis by glucose 6-phosphatase is correct?
- Because hexokinase has a low K_m its activity in liver increases as the concentration of glucose in the portal blood increases.
 - Glucose-6-phosphatase is mainly active in muscle in the fasting state.
 - If hexokinase and glucose-6-phosphatase are both equally active at the same time there is net formation of ATP from ADP and phosphate.
 - Liver contains an isoenzyme of hexokinase, glucokinase, which is especially important in the fed state.
 - Muscle can release glucose into the circulation from its glycogen reserves in the fasting state.
15. Which one of following statements about this step in glycolysis catalyzed by phosphofructokinase and in gluconeogenesis by fructose 1,6-bisphosphatase is correct?
- Fructose 1,6-bisphosphatase is mainly active in the liver in the fed state.
 - Fructose 1,6-bisphosphatase is mainly active in the liver in the fed state.
 - If phosphofructokinase and fructose 1,6-bisphosphatase are both equally active at the same time, there is a net formation of ATP from ADP and phosphate.
 - Phosphofructokinase is inhibited more or less completely by physiological concentrations of ATP.
 - Phosphofructokinase is mainly active in the liver in the fasting state.
16. Which one of the following statements about glucose metabolism in maximum exertion is correct?
- Gluconeogenesis from lactate requires less ATP than is formed during anaerobic glycolysis.
 - In maximum exertion pyruvate is oxidized to lactate in muscle.
 - Oxygen debt is caused by the need to exhale carbon dioxide produced in response to acidosis.
 - Oxygen debt reflects the need to replace oxygen that has been used in muscle during vigorous exercise.
 - There is metabolic acidosis as a result of vigorous exercise.
17. Which one of following statements is correct?
- Glucose-1-phosphate may be hydrolyzed to yield free glucose in liver.
 - Glucose-6-phosphate can be formed from glucose, but not from glycogen.
 - Glucose-6-phosphate cannot be converted to glucose 1-phosphate in liver.
 - Glucose-6-phosphate is formed from glycogen by the action of the enzyme glycogen phosphorylase.
 - In liver and red blood cells, glucose-6-phosphate may enter into either glycolysis or the pentose phosphate pathway.
18. Which one of following statements about the pyruvate dehydrogenase multienzyme complex is correct?
- In thiamin (vitamin B_1) deficiency, pyruvate formed in muscle cannot be transaminated to alanine.
 - In thiamin (vitamin B_1) deficiency, pyruvate formed in muscle cannot be carboxylated to oxaloacetate.
 - The reaction of pyruvate dehydrogenase involves decarboxylation and oxidation of pyruvate, then formation of acetyl CoA.
 - The reaction of pyruvate dehydrogenase is readily reversible, so that acetyl CoA can be used for the synthesis of pyruvate, and hence glucose.
 - The reaction of pyruvate dehydrogenase leads to the oxidation of NADH to NAD^+ , and hence the formation of $\sim 2.5 \times$ ATP per mol of pyruvate oxidized.

19. Which one of following statements about the pentose phosphate pathway is correct?
- In favism red blood cells are more susceptible to oxidative stress because of a lack of NADPH for fatty acid synthesis.
 - People who lack glucose-6-phosphate dehydrogenase cannot synthesize fatty acids because of a lack of NADPH in liver and adipose tissue.
 - The pentose phosphate pathway is especially important in tissues that are synthesizing fatty acids.
 - The pentose phosphate pathway is the only source of NADPH for fatty acid synthesis.
 - The pentose phosphate pathway provides an alternative to glycolysis only in the fasting state.
20. Which one of following statements about glycogen metabolism is correct?
- Glycogen is synthesized in the liver in the fed state, then exported to other tissues in low density lipoproteins.
 - Glycogen reserves in liver and muscle will meet energy requirements for several days in prolonged fasting.
 - Liver synthesizes more glycogen when the hepatic portal blood concentration of glucose is high because of the activity of gluco kinase in the liver.
 - Muscle synthesizes glycogen in the fed state because glycogen phosphorylase is activated in response to insulin.
 - The plasma concentration of glycogen increases in the fed state.
21. Which one of following statements about gluconeogenesis is correct?
- Because they form acetyl CoA, fatty acids can be a substrate for gluconeogenesis.
 - If oxaloacetate is withdrawn from the citric acid cycle for gluconeogenesis then it can be replaced by the action of pyruvate dehydrogenase.
 - The reaction of phosphoenolpyruvate carboxykinase is important to replenish the pool of citric acid cycle intermediates.
 - The use of GTP as the phosphate donor in the phosphoenolpyruvate carboxykinase reaction provides a link between citric acid cycle activity and gluconeogenesis.
 - There is a greater yield of ATP in anaerobic glycolysis than the cost for synthesis of glucose from lactate.
22. Which one of following statements about carbohydrate metabolism is correct?
- A key step in the biosynthesis of glycogen is the formation of UDP-glucose.
 - Glycogen can be broken down to glucose-6-phosphate in muscle, which then releases free glucose by the action of the enzyme glucose-6-phosphatase.
 - Glycogen is stored mainly in the liver and brain.
 - Insulin inhibits the biosynthesis of glycogen.
 - Phosphorylase kinase is an enzyme that phosphorylates the enzyme glycogen phosphorylase and thereby decreases glycogen breakdown.
23. Which one of following statements about glycogen metabolism is correct?
- Glycogen synthase activity is increased by glucagon.
 - Glycogen phosphorylase is an enzyme that can be activated by phosphorylation of serine residues.
 - Glycogen phosphorylase cannot be activated by calcium ions.
 - cAMP activates glycogen synthesis.
 - Glycogen phosphorylase breaks the α 1-4 glycosidic bonds by hydrolysis.
24. Which one of following statements about glucose metabolism is correct?
- Glucagon increases the rate of glycolysis.
 - Glycolysis requires NADP⁺.
 - In glycolysis, glucose is cleaved into two three carbon compounds.
 - Substrate level phosphorylation takes place in the electron transport system.
 - The main product of glycolysis in red blood cells is pyruvate.
25. Which one of following statements about metabolism of sugars is correct?
- Fructokinase phosphorylates fructose to fructose-6-phosphate.
 - Fructose is an aldose sugar like glucose.
 - Fructose transport into cells is insulin dependent.
 - Galactose is phosphorylated to galactose-1-phosphate by galactokinase.
 - Sucrose can be biosynthesized from glucose and fructose in the liver.
26. In glycolysis, the conversion of 1 mol of fructose 1,6-bisphosphate to 2 mol of pyruvate results in the formation of:
- 1 mol NAD⁺ and 2 mol of ATP
 - 1 mol NADH and 1 mol of ATP
 - 2 mol NAD⁺ and 4 mol of ATP
 - 2 mol NADH and 2 mol of ATP
 - 2 mol NADH and 4 mol of ATP
27. Which of the following will provide the main fuel for muscle contraction during short-term maximum exertion?
- Muscle glycogen
 - Muscle reserves of triacylglycerol
 - Plasma glucose
 - Plasma nonesterified fatty acids
 - Triacylglycerol in plasma very low density lipoprotein

28. The disaccharide lactulose is not digested, but is fermented by intestinal bacteria, to yield 4 mol of lactate plus 4 protons. Ammonium (NH_4^+) is in equilibrium with ammonia (NH_3) in the bloodstream. Which of the following best explains how lactulose acts to treat hyperammonemia (elevated blood ammonium concentration)?
- A. Fermentation of lactulose increases the acidity of the bloodstream so that there is more ammonium and less ammonia is available to cross the gut wall.
 - B. Fermentation of lactulose results in acidification of the gut contents so that ammonia diffuses from the bloodstream into the gut and is trapped as ammonium that cannot cross back.
 - C. Fermentation of lactulose results in acidification of the gut contents so that ammonia produced by intestinal bacteria is trapped as ammonium that cannot diffuse into the bloodstream.
 - D. Fermentation of lactulose results in an eightfold increase in the osmolality of the gut contents, so that there is more water for ammonia and ammonium to dissolve in, so that less is absorbed into the bloodstream.
 - E. Fermentation of lactulose results in an eightfold increase in the osmolality of the gut contents, so that there is more water for ammonia and ammonium to dissolve in, so that more will diffuse for the bloodstream into the gut.

Lipids of Physiologic Significance

Kathleen M. Botham, PhD, DSc & Peter A. Mayes, PhD, DSc

OBJECTIVES

After studying this chapter, you should be able to:

- Define simple and complex lipids and identify the lipid classes in each group.
- Indicate the structure of saturated and unsaturated fatty acids, explain how the chain length and degree of unsaturation influence their melting point, give examples, and explain the nomenclature.
- Understand the difference between *cis* and *trans* carbon-carbon double bonds.
- Describe how eicosanoids are formed by modification of the structure of unsaturated fatty acids; identify the various eicosanoid classes and indicate their functions.
- Outline the general structure of triacylglycerols and indicate their function.
- Outline the general structure of phospholipids and glycosphingolipids and indicate the functions of the different classes.
- Appreciate the importance of cholesterol as the precursor of many biologically important steroids, including steroid hormones, bile acids, and vitamins D.
- Recognize the cyclic nucleus common to all steroids and explain the difference between the “chair” and “boat” forms of the six-carbon rings and that the rings may be either *cis* or *trans* in relation to each other, making many stereoisomers possible.
- Explain why free radicals are damaging to tissues and identify the three stages in the chain reaction of lipid peroxidation that produces them continuously.
- Understand how antioxidants protect lipids from peroxidation by either inhibiting chain initiation or breaking the chain and give physiological and nonphysiological examples.
- Understand that many lipid molecules are amphipathic, having both hydrophobic and hydrophilic groups in their structure, and explain how this influences their behavior in an aqueous environment and enables certain classes, including phospholipids, sphingolipids, and cholesterol, to form the basic structure of biologic membranes.

BIOMEDICAL IMPORTANCE

The lipids are a heterogeneous group of compounds, including fats, oils, steroids, waxes, and related compounds, that are related more by their physical than by their chemical properties. They have the common property of being (1) relatively **insoluble in water** and (2) **soluble in nonpolar solvents** such as ether and chloroform. They are important dietary constituents not only because of the high energy value of fats, but also because essential fatty acids and **fat-soluble vitamins** and other lipophilic **micronutrients** are contained in the fat of natural foods. Dietary supplementation with **long chain ω3 fatty acids** is believed to have beneficial effects in a number of chronic diseases, including cardiovascular disease, rheumatoid arthritis and dementia. Fat is stored in **adipose tissue**, where it also serves as a thermal insulator in the subcutaneous tissues and around certain organs. Nonpolar lipids act as **electrical insulators**, allowing rapid propagation of depolarization waves along **myelinated nerves**. Lipids are transported in the blood combined with proteins in **lipoprotein** particles (see Chapters 25 and 26). Lipids have essential roles in nutrition and health and knowledge of lipid biochemistry is necessary for the understanding of many important biomedical conditions, including **obesity, diabetes mellitus, and atherosclerosis**.

LIPIDS ARE CLASSIFIED AS SIMPLE OR COMPLEX

- Simple lipids** include fats and waxes which are esters of fatty acids with various alcohols:
 - Fats:** Esters of fatty acids with glycerol. **Oils** are fats in the liquid state.
 - Waxes:** Esters of fatty acids with higher molecular weight monohydric alcohols.
- Complex lipids** are esters of fatty acids containing groups in addition to an alcohol and one or more fatty acids. They can be divided into three groups:
 - Phospholipids:** Lipids containing, in addition to fatty acids and an alcohol, a phosphoric acid residue. They frequently have nitrogen-containing bases (eg, choline) and other substituents. In many phospholipids the alcohol is glycerol (**glycerophospholipids**), but in **sphingophospholipids** it is sphingosine, which contains an amino group.
 - Glycolipids (glycosphingolipids):** Lipids containing a fatty acid, sphingosine, and carbohydrate.
 - Other complex lipids:** Lipids such as sulfolipids and amino lipids. Lipoproteins may also be placed in this category.
- Precursor and derived lipids:** These include fatty acids, glycerol, steroids, other alcohols, fatty aldehydes, ketone bodies (see Chapter 22), hydrocarbons, lipid-soluble vitamins and micronutrients, and hormones.

Because they are uncharged, acylglycerols (glycerides), cholesterol, and cholesteryl esters are termed **neutral lipids**.

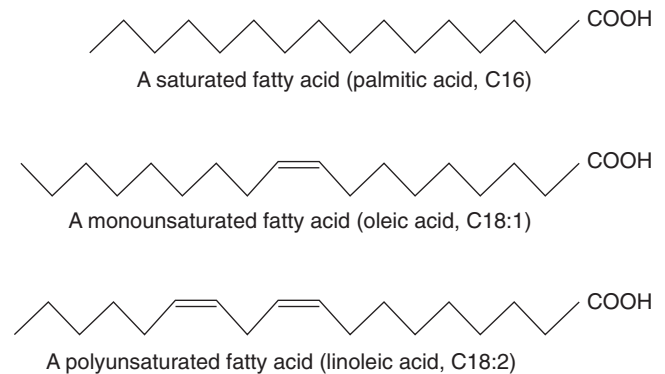

FIGURE 21-1 Fatty acids. Examples of a saturated (palmitic acid), monounsaturated (oleic acid), and a polyunsaturated (linoleic acid) fatty acid are shown.

FATTY ACIDS ARE ALIPHATIC CARBOXYLIC ACIDS

Fatty acids occur in the body mainly as esters in natural fats and oils, but are found in the unesterified form as **free fatty acids**, a transport form in the plasma. Fatty acids that occur in natural fats usually contain an even number of carbon atoms. The chain may be **saturated** (containing no double bonds) or **unsaturated** (containing one or more double bonds) (Figure 21-1).

Fatty Acids Are Named After Corresponding Hydrocarbons

The most frequently used systematic nomenclature names the fatty acid after the hydrocarbon with the same number and arrangement of carbon atoms, with **-oic** being substituted for the final **-e** (Genevan system). Thus, saturated acids end in **-anoic**, for example, octanoic acid (C8), and unsaturated acids with double bonds end in **-enoic**, for example, octadecenoic acid (oleic acid, C18).

Carbon atoms are numbered from the carboxyl carbon (carbon no. 1). The carbon atoms adjacent to the carboxyl carbon (nos. 2, 3, and 4) are also known as the α , β , and γ carbons, respectively, and the terminal methyl carbon is known as the ω - or n-carbon.

Various conventions use Δ for indicating the number and position of the double bonds (Figure 21-2); for example, Δ^9 indicates a double bond between carbons 9 and 10 of the fatty acid; $\omega 9$ indicates a double bond on the ninth carbon counting from the ω -carbon. In animals, additional double bonds are introduced only between an existing double bond at the $\omega 9$, $\omega 6$, or $\omega 3$ position and the carboxyl carbon, leading to three series of fatty acids known as the **$\omega 9$, $\omega 6$, and $\omega 3$ families**, respectively.

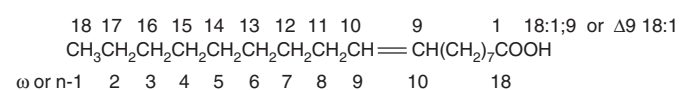

FIGURE 21-2 Nomenclature for number and position of double bonds in unsaturated fatty acids. Illustrated using oleic acid as an example. $n-9$ is equivalent to $\omega 9$.

Saturated Fatty Acids Contain No Double Bonds

Saturated fatty acids may be envisaged as based on acetic acid ($\text{CH}_3\text{—COOH}$) as the first member of the series in which $\text{—CH}_2\text{—}$ is progressively added between the terminal $\text{CH}_3\text{—}$ and —COOH groups. Examples are shown in **Table 21–1**. Other higher members of the series are known to occur, particularly in waxes. A few branched-chain fatty acids have also been isolated from both plant and animal sources.

Unsaturated Fatty Acids Contain One or More Double Bonds

Unsaturated fatty acids (see **Figure 21–1**, **Table 21–2**, for examples) may be further subdivided as follows:

1. **Monounsaturated** (monoethenoid, monoenoic) acids, containing one double bond.
2. **Polyunsaturated** (polyethenoid, polyenoic) acids, containing two or more double bonds.
3. **Eicosanoids**: These compounds, derived from eicosa (20-carbon) polyenoic fatty acids (see Chapter 23), comprise the **prostanoids**, **leukotrienes (LTs)**, and **lipoxins (LXs)**. Prostanoids include **prostaglandins (PGs)**, **prostacyclins (PGIs)**, and **thromboxanes (TXs)**.

Prostaglandins exist in virtually every mammalian tissue, acting as local hormones; they have important physiologic and pharmacologic activities. They are synthesized in vivo by cyclization of the center of the carbon chain of 20-carbon (eicosanoic) polyunsaturated fatty acids (eg, arachidonic acid) to form a cyclopentane ring (**Figure 21–3**). A related series of compounds, the **thromboxanes**, have the cyclopentane ring interrupted with an oxygen atom (oxane ring) (**Figure 21–4**). Three different eicosanoic fatty acids give rise to three groups

TABLE 21–1 Saturated Fatty Acids

Common Name	Number of C Atoms	Occurrence
Acetic	2	Major end product of carbohydrate fermentation by rumen organisms
Butyric	4	In certain fats in small amounts (especially butter). An end product of carbohydrate fermentation by rumen organisms ^a
Valeric	5	
Caproic	6	
Lauric	12	Spermaceti, cinnamon, palm kernel, coconut oils, laurels, butter
Myristic	14	Nutmeg, palm kernel, coconut oils, myrtles, butter
Palmitic	16	Common in all animal and plant fats
Stearic	18	

^aAlso formed in the cecum of herbivores and to a lesser extent in the colon of humans.

of eicosanoids characterized by the number of double bonds in the side chains (see **Figure 23–12**), for example, prostaglandin (PG)₁, PG ₂, and PG ₃. Different substituent groups attached to the rings give rise to series of prostaglandins and thromboxanes labeled A, B, etc (see **Figure 23–13**),—for example, the “E” type of prostaglandin (as in PGE_2) has a keto group in position 9, whereas the “F” type has a hydroxyl group in this position. The **leukotrienes** and **lipoxins** (**Figure 21–5**) are a third group of eicosanoid derivatives formed via the **lipoxygenase pathway** (see **Figure 23–14**). They are characterized by the presence of three or four conjugated double bonds, respectively. Leukotrienes cause bronchoconstriction as well as being potent proinflammatory agents, and play a part in **asthma**.

Most Naturally Occurring Unsaturated Fatty Acids Have *cis* Double Bonds

The carbon chains of saturated fatty acids form a zigzag pattern when extended at low temperatures (**Figure 21–1**). At higher temperatures, some bonds rotate, causing chain shortening, which explains why biomembranes become thinner with increases in temperature. A type of **geometric isomerism** occurs in unsaturated fatty acids, depending on the orientation of atoms or groups around the axes of double bonds, which do not allow rotation. If the acyl chains are on the same side of the bond, it is ***cis***-, as in oleic acid; if on opposite sides, it is ***trans***-, as in elaidic acid, the ***trans*** isomer of oleic acid (**Figure 21–6**). Double bonds in naturally occurring unsaturated long-chain fatty acids are nearly all in the ***cis*** configuration, the molecules being “bent” 120° at the double bond. Thus, oleic acid has a V shape, whereas elaidic acid remains “straight.” Increase in the number of ***cis*** double bonds in a fatty acid leads to a variety of possible spatial configurations of the molecule—for example, arachidonic acid, with four ***cis*** double bonds, is bent into a U shape (**Figure 21–7**). This has profound significance for molecular packing in cell membranes (see Chapter 40) and on the positions occupied by fatty acids in more complex molecules such as phospholipids. ***Trans*** double bonds alter these spatial relationships. ***Trans*** fatty acids are present in certain foods, arising as a by-product of the saturation of fatty acids during hydrogenation, or “hardening,” of natural oils in the manufacture of margarine. An additional small contribution comes from the ingestion of ruminant fat that contains ***trans*** fatty acids arising from the action of microorganisms in the rumen. Consumption of ***trans*** fatty acids is now known to be detrimental to health and is associated with increased risk of diseases including cardiovascular disease and diabetes mellitus. This has led to improved technology to produce soft margarine low in ***trans*** fatty acids or containing none at all.

Physical and Physiologic Properties of Fatty Acids Reflect Chain Length and Degree of Unsaturation

The melting points of even-numbered carbon fatty acids increase with chain length and decrease according to unsaturation.

TABLE 21-2 Unsaturated Fatty Acids of Physiologic and Nutritional Significance

Number of C Atoms and Number and Position of Common Double Bonds	Family	Common Name	Systematic Name	Occurrence
Monoenoic acids (one double bond)				
16:1;9	ω 7	Palmitoleic	<i>cis</i> -9-Hexadecenoic	In nearly all fats
18:1;9	ω 9	Oleic	<i>cis</i> -9-Octadecenoic	Possibly the most common fatty acid in natural fats; particularly high in olive oil
18:1;9	ω 9	Elaidic	<i>trans</i> -9-Octadecenoic	Hydrogenated and ruminant fats
Dienoic acids (two double bonds)				
18:2;9,12	ω 6	Linoleic	all- <i>cis</i> -9,12-Octadecadienoic	Corn, peanut, cottonseed, soy bean, and many plant oils
Trienoic acids (three double bonds)				
18:3;6,9,12	ω 6	γ -Linolenic	all- <i>cis</i> -6,9,12-Octadecatrienoic	Some plants, eg, oil of evening primrose, borage oil; minor fatty acid in animals
18:3;9,12,15	ω 3	α -Linolenic	all- <i>cis</i> -9,12,15-Octadecatrienoic	Frequently found with linoleic acid but particularly in linseed oil
Tetraenoic acids (four double bonds)				
20:4;5,8,11,14	ω 6	Arachidonic	all- <i>cis</i> -5,8,11,14-Eicosatetraenoic	Found in animal fats; important component of phospholipids in animals
Pentaenoic acids (five double bonds)				
20:5;5,8,11,14,17	ω 3	Eicosapentaenoic	all- <i>cis</i> -5,8,11,14,17-Eicosapentaenoic	Important component of fish oils, eg, cod liver, mackerel, menhaden, salmon oils
Hexaenoic acids (six double bonds)				
22:6;4,7,10,13,16,19	ω 3	Docosahexaenoic	all- <i>cis</i> -4,7,10,13,16,19-Docosahexaenoic	Fish oils, algal oils, phospholipids in brain

A triacylglycerol containing three saturated fatty acids of 12 carbons or more is solid at body temperature, whereas if the fatty acid residues are polyunsaturated, it is liquid to below 0°C. In practice, natural acylglycerols contain a mixture of fatty acids tailored to suit their functional roles. For example, membrane lipids, which must be fluid at all environmental temperatures, are more unsaturated than storage lipids. Lipids in tissues that are subject to cooling, for example, in hibernators or in the extremities of animals, are also more unsaturated.

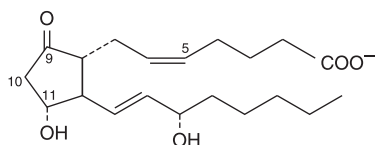
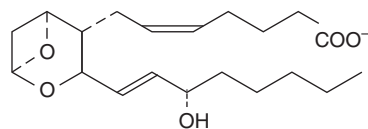
**FIGURE 21-3** Prostaglandin E₂ (PGE₂).**FIGURE 21-4** Thromboxane A₂ (TXA₂).

ω 3 Fatty Acids Are Anti-Inflammatory and Have Health Benefits

Long chain ω 3 fatty acids such as α -linolenic (ALA) (found in plant oils), eicosapentaenoic (EPA) (found in fish oil) and docosahexaenoic (DHA) (found in fish and algal oils) (Table 21-2) have anti-inflammatory effects, perhaps due to their effects in promoting the synthesis of less inflammatory prostaglandins and leukotrienes as compared to ω 6 fatty acids (see Figure 23-12). In view of this, their potential use

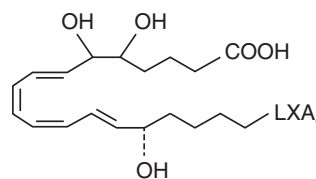
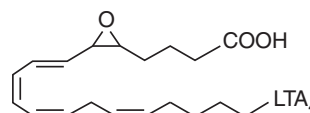
**FIGURE 21-5** Leukotriene and lipoxin structure. Examples shown are leukotriene A₄ (LTA₄) and lipoxin A₄ (LXA₄).

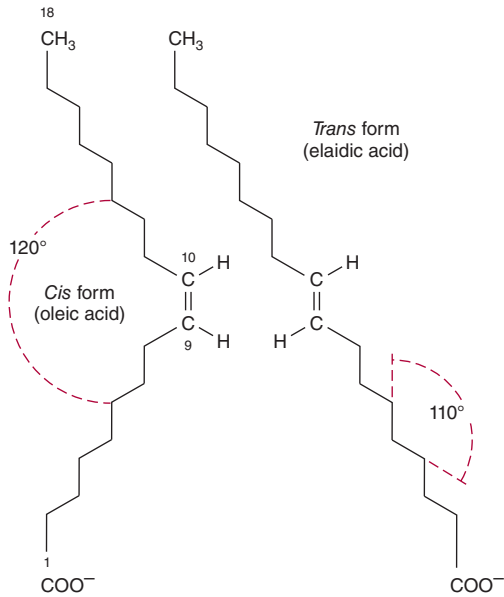

FIGURE 21-6 Geometric isomerism of Δ^9 , 18:1 fatty acids (oleic and elaidic acids). There is no rotation around carbon-carbon double bonds. In the *cis* configuration, the acyl chains are on the same side of the bond, while in *trans* form they are on opposite sides.

as a therapy in severe chronic disease where inflammation is a contributory cause is under intensive investigation. Current evidence suggests that diets rich in ω 3 fatty acids are beneficial, particularly for **cardiovascular disease**, but also for other chronic degenerative diseases such as **cancer**, **rheumatoid arthritis**, and **Alzheimer disease**.

TRIACYLGLYCEROLS (TRIGLYCERIDES)* ARE THE MAIN STORAGE FORMS OF FATTY ACIDS

The triacylglycerols (**Figure 21-8**) are esters of the trihydric alcohol glycerol and fatty acids. Mono- and diacylglycerols, wherein one or two fatty acids are esterified with glycerol, are also found in the tissues. These are of particular significance in the synthesis and hydrolysis of triacylglycerols (see Chapters 24 and 25).

Carbons 1 & 3 of Glycerol Are Not Identical

To number the carbon atoms of glycerol unambiguously, the *-sn* (stereochemical numbering) system is used. It is important to realize that carbons 1 and 3 of glycerol are not identical when viewed in three dimensions (shown as a projection formula

*According to the standardized terminology of the International Union of Pure and Applied Chemistry and the International Union of Biochemistry, the monoglycerides, diglycerides, and triglycerides should be designated monoacylglycerols, diacylglycerols, and triacylglycerols, respectively. However, the older terminology is still widely used, particularly in clinical medicine.

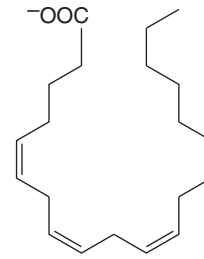

FIGURE 21-7 Arachidonic acid. Four double bonds in the *cis* configuration bend the molecule into a U shape.

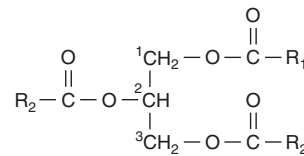

FIGURE 21-8 Triacylglycerol.

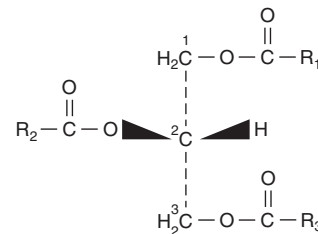

FIGURE 21-9 Projection formula showing triacyl-*sn*-glycerol.

in **Figure 21-9**). Enzymes readily distinguish between them and are nearly always specific for one or the other carbon; for example, glycerol is always phosphorylated on *sn*-3 by glycerol kinase to give glycerol-3-phosphate and not glycerol-1-phosphate (see **Figure 24-2**).

PHOSPHOLIPIDS ARE THE MAIN LIPID CONSTITUENTS OF MEMBRANES

Many phospholipids are derivatives of **phosphatidic acid** (**Figure 21-10**), in which the phosphate is esterified with one OH group of glycerol and the other two OH groups are esterified to two long chain fatty acids (glycerophospholipids). Phosphatidic acid is important as an intermediate in the synthesis of triacylglycerols as well as phosphoglycerols (see **Figure 24-2**) but is not found in any great quantity in tissues. Sphingolipids such as **sphingomyelin**, in which the phosphate is esterified to **sphingosine**, a complex amino alcohol (**Figure 21-11**), are also important membrane components. Both glycerophospholipids and sphingolipids have two long chain hydrocarbon tails which are important for their function in forming the lipid bilayer in cell membranes (see Chapter 40), but in the former both are fatty acid chains while in the latter one is a fatty acid and the second is part of the sphingosine molecule (**Figure 21-12**).

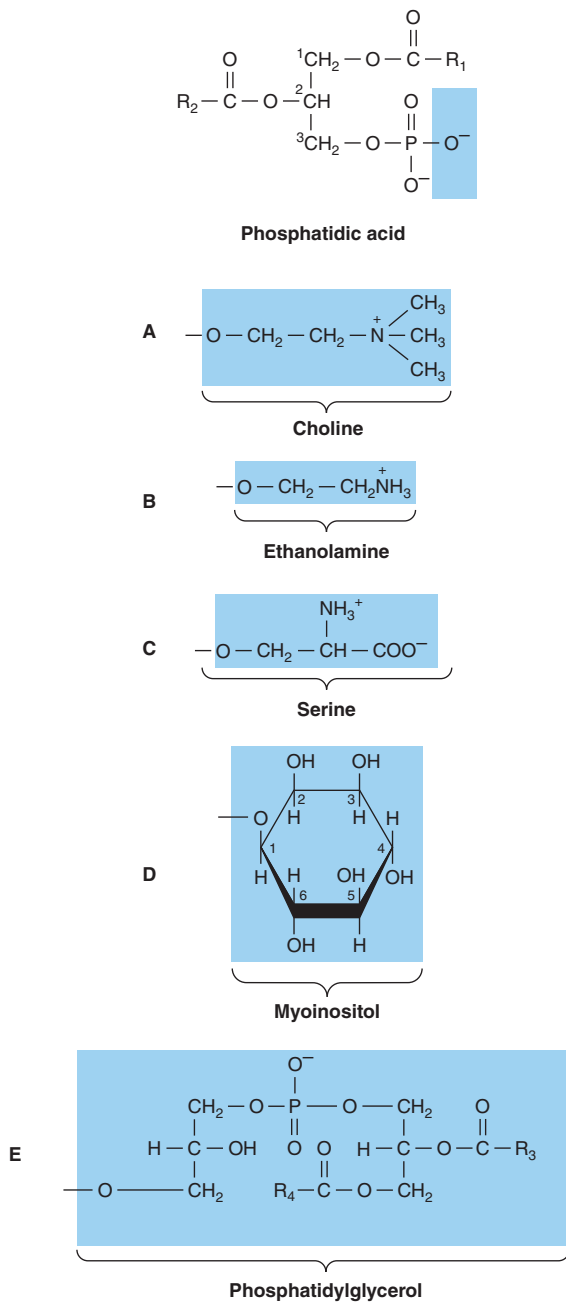

FIGURE 21-10 Phospholipids. The O— shown shaded in phosphatidic acid is substituted by the substituents shown to form the phospholipids: **(A)** 3-phosphatidylcholine, **(B)** 3-phosphatidylethanolamine, **(C)** 3-phosphatidylserine, **(D)** 3-phosphatidylinositol, and **(E)** cardiolipin (diphosphatidylglycerol).

Phosphatidylcholines (Lecithins) and Sphingomyelins Are Abundant in Cell Membranes

Glycerophospholipids containing **choline** (Figure 21-10), (phosphatidylcholines, commonly called **lecithins**) are the most abundant phospholipids of the cell membrane and represent a large proportion of the body's store of choline. Choline

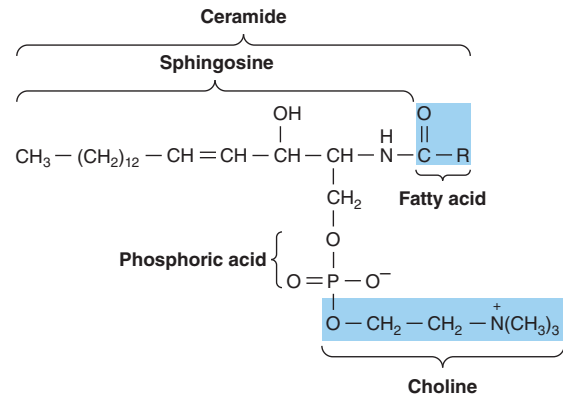

FIGURE 21-11 A sphingomyelin.

is important in nervous transmission, as acetylcholine, and as a store of labile methyl groups. **Dipalmitoyl lecithin** is a very effective surface-active agent and a major constituent of the **surfactant** preventing adherence, due to surface tension, of the inner surfaces of the lungs. Its absence from the lungs of premature infants causes **respiratory distress syndrome**. Most phospholipids have a saturated acyl radical in the *sn*-1 position but an unsaturated radical in the *sn*-2 position of glycerol.

Phosphatidylethanolamine (cephalin) and **phosphatidylserine** (found in most tissues) are also found in cell membranes and differ from phosphatidylcholine only in that ethanolamine or serine, respectively, replaces choline (Figure 21-10). Phosphatidylserine also plays a role in **apoptosis** (programmed cell death).

Sphingomyelins are found in the outer leaflet of the cell membrane lipid bilayer and are particularly abundant in specialized areas of the plasma membrane known as **lipid rafts** (see Chapter 40). They are also found in large quantities in the **myelin sheath** that surrounds nerve fibers. They are believed to play a role in **cell signaling** and in **apoptosis**. Sphingomyelins contain no glycerol, and on hydrolysis they yield a fatty acid, phosphoric acid, choline, and sphingosine (Figure 21-11). The combination of sphingosine plus fatty acid is known as **ceramide**, a structure also found in the glycosphingolipids (see next section below).

Phosphatidylinositol Is a Precursor of Second Messengers

The inositol is present in **phosphatidylinositol** as the stereoisomer, myoinositol (Figure 21-10). Phosphorylated phosphatidylinositols (**phosphoinositides**) are minor components of cell membranes, but play an important part in **cell signaling and membrane trafficking**. Phosphoinositides may have 1, 2, or 3 phosphate groups attached to the inositol ring. **Phosphatidylinositol 4,5-bisphosphate (PIP₂)**, for example, is cleaved into **diacylglycerol** and **inositol tris-phosphate** upon stimulation by a suitable hormone agonist, and both of these act as internal signals or second messengers.

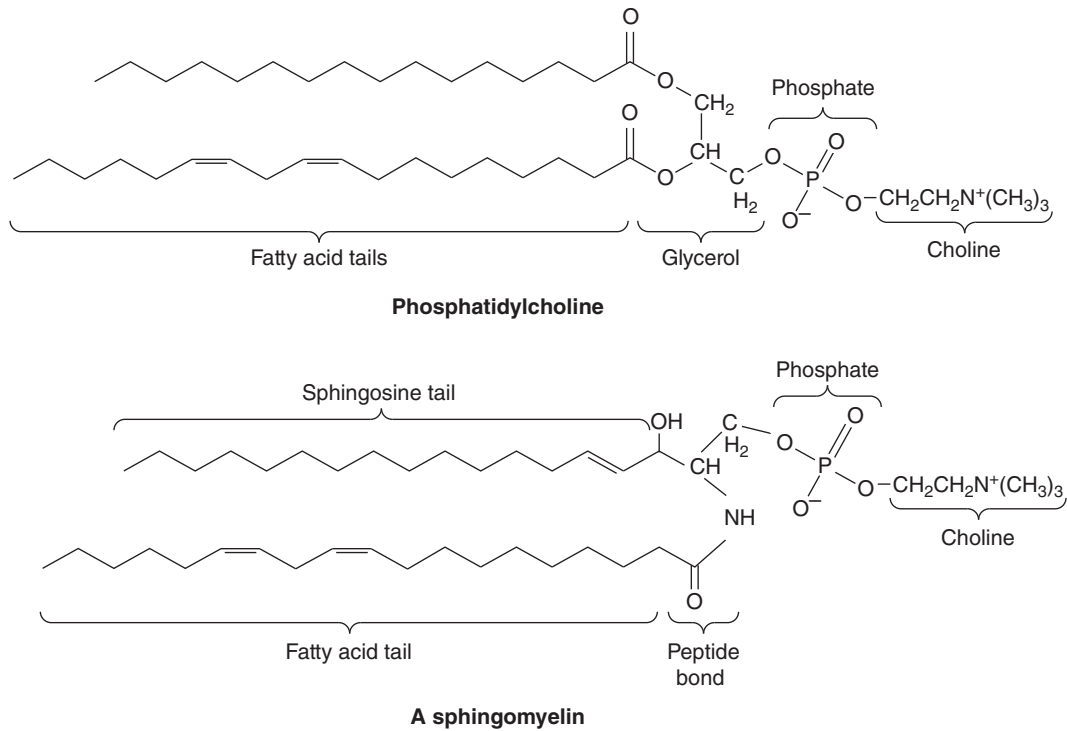

FIGURE 21-12 Comparison of glycerophospholipid and sphingolipid structures. Both types of phospholipid have two hydrocarbon tails, in glycerophospholipids both are fatty acid chains (a phosphatidylcholine with one saturated and one unsaturated fatty acid is shown) and in sphingolipids one is a fatty acid chain and the other is part of the sphingosine moiety (a sphingomyelin is shown). The two hydrophobic tails and the polar head group are important for the function of these phospholipids in the lipid bilayer in cell membranes (see Chapter 40).

Cardiolipin Is a Major Lipid of Mitochondrial Membranes

Phosphatidic acid is a precursor of **phosphatidylglycerol**, which in turn gives rise to **cardiolipin** (Figure 21-10). This phospholipid is found only in mitochondria and is essential for the mitochondrial function. Decreased cardiolipin levels or alterations in its structure or metabolism cause mitochondrial dysfunction in aging and in pathological conditions including heart failure, hypothyroidism, and Barth syndrome (cardioskeletal myopathy).

Lysophospholipids Are Intermediates in the Metabolism of Phosphoglycerols

These are phosphoacylglycerols containing only one acyl radical, for example, **lysophosphatidylcholine (lysolecithin)** (Figure 21-13), important in the metabolism and interconversion

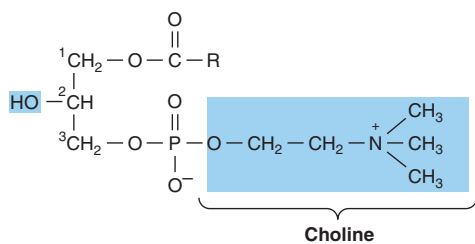

FIGURE 21-13 Lysophosphatidylcholine (lysolecithin).

of phospholipids. It is also found in oxidized lipoproteins and has been implicated in some of their effects in promoting **atherosclerosis**.

Plasmalogens Occur in Brain & Muscle

These compounds constitute as much as 10% to 30% of the phospholipids of brain and heart. Structurally, the plasmalogens resemble phosphatidylethanolamine but possess an ether link on the *sn*-1 carbon instead of the ester link found in acylglycerols. Typically, the alkyl radical is an unsaturated alcohol (Figure 21-14). In some instances, choline, serine, or inositol may be substituted for ethanolamine. The function of plasmalogens remain poorly understood, but it has been suggested that they may have a protective effect against reactive oxygen species.

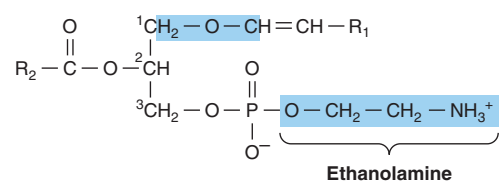

FIGURE 21-14 Plasmalogen.

GLYCOLIPIDS (GLYCOSPHINGOLIPIDS) ARE IMPORTANT IN NERVE TISSUES & IN THE CELL MEMBRANE

Glycolipids are lipids with an attached carbohydrate or carbohydrate chain. They are widely distributed in every tissue of the body, particularly in nervous tissue such as brain. They occur particularly in the outer leaflet of the plasma membrane, where they contribute to **cell surface carbohydrates** which form the **glycocalyx** (see Chapter 15).

The major glycolipids found in animal tissues are glycosphingolipids. They contain ceramide and one or more sugars. **Galactosylceramide** (Figure 21–15) is a major glycosphingolipid of brain and other nervous tissue, found in relatively low amounts elsewhere. It contains a number of characteristic C24 fatty acids, for example, cerebronic acid.

Galactosylceramide can be converted to sulfogalactosylceramide (**sulfatide**) which has a sulfo group attached to the O in the three position of galactose and is present in high amounts in **myelin**. **Glucosylceramide** resembles galactosylceramide, but the head group is glucose rather than galactose. It is the predominant simple glycosphingolipid of extraneural tissues, also occurring in the brain in small amounts. **Gangliosides** are complex glycosphingolipids derived from glucosylceramide that contain in addition one or more molecules of a **sialic acid**. **Neuraminic acid** (NeuAc; see Chapter 15) is the principal sialic acid found in human tissues. Gangliosides are also present in nervous tissues in high concentration. They function in cell-cell recognition and communication and as receptors for hormones and bacterial toxins such as cholera toxin. The simplest ganglioside found in tissues is **GM₃**, which contains ceramide, one molecule of glucose, one molecule of galactose, and one molecule of NeuAc. In the shorthand nomenclature used, G represents ganglioside; M is a monosialo-containing species; and the subscript 3 is a number assigned on the basis of chromatographic migration. **GM1** (Figure 21–16), a more complex ganglioside derived from GM₃, is of considerable biologic interest, as it is known to be the receptor in human intestine for **cholera toxin**. Other gangliosides can contain

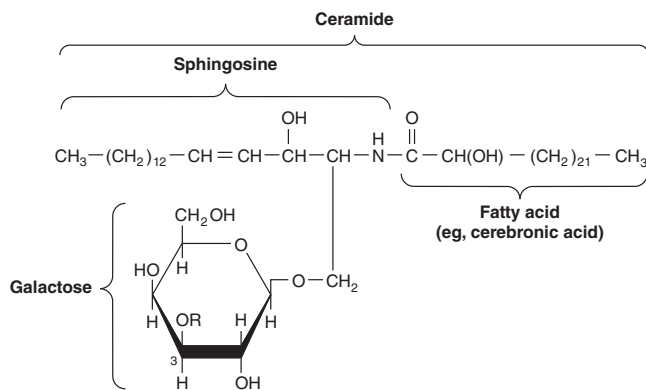

FIGURE 21–15 Structure of galactosylceramide.

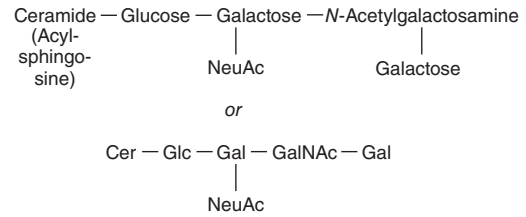

FIGURE 21–16 GM1 ganglioside, a monosialoganglioside, the receptor in human intestine for cholera toxin.

anywhere from one to five molecules of sialic acid, giving rise to di-, trisialogangliosides, etc.

STERIODS PLAY MANY PHYSIOLOGICALLY IMPORTANT ROLES

Although **cholesterol** is probably best known for its association with **atherosclerosis** and heart disease, it has a number of essential roles in the body. It is the precursor of a large number of equally important **steroids** that include the **bile acids**, **adrenocortical hormones**, **sex hormones**, **vitamin D**, and **cardiac glycosides**.

All steroids have a similar cyclic nucleus resembling phenanthrene (rings A, B, and C) to which a cyclopentane ring (D) is attached. The carbon positions on the steroid nucleus are numbered as shown in Figure 21–17. It is important to realize that in structural formulas of steroids, a simple hexagonal ring denotes a completely saturated six-carbon ring with all valences satisfied by hydrogen bonds unless shown otherwise; that is, it is not a benzene ring. All double bonds are shown as such. Methyl side chains are shown as single bonds unattached at the farther (methyl) end. These occur typically at positions 10 and 13 (constituting C atoms 19 and 18). A side chain at position 17 is usual (as in cholesterol). If the compound has one or more hydroxyl groups and no carbonyl or carboxyl groups, it is a **sterol**, and the name terminates in *-ol*.

Because of Asymmetry in the Steroid Molecule, Many Stereoisomers Are Possible

Each of the six-carbon rings of the steroid nucleus is capable of existing in the three-dimensional conformation either of a “chair” or a “boat” (Figure 21–18). In naturally occurring steroids, virtually all the rings are in the “chair” form, which

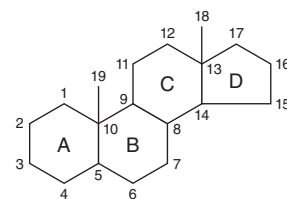

FIGURE 21–17 The steroid nucleus.

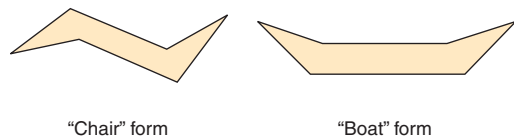

FIGURE 21-18 Conformations of stereoisomers of the steroid nucleus.

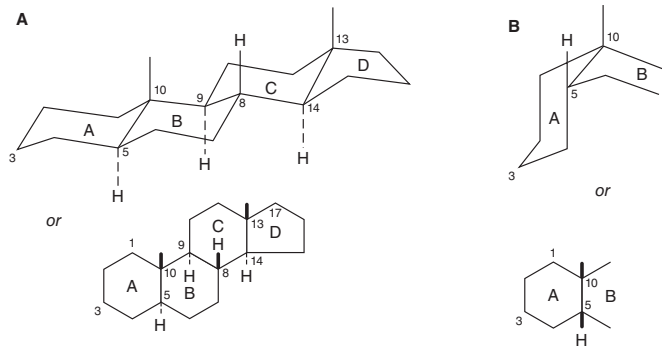

FIGURE 21-19 Generalized steroid nucleus, showing (A) an all-*trans* configuration between adjacent rings and (B) a *cis* configuration between rings A and B.

is the more stable conformation. With respect to each other, the rings can be either *cis* or *trans* (Figure 21-19). The junction between the A and B rings can be *cis* or *trans* in naturally occurring steroids. That between B and C is *trans*, as is usually the C/D junction. Bonds attaching substituent groups above the plane of the rings (β bonds) are shown with bold solid lines, whereas those bonds attaching groups below (α bonds) are indicated with broken lines. The A ring of a 5α steroid is always *trans* to the B ring, whereas it is *cis* in a 5β steroid. The methyl groups attached to C10 and C13 are invariably in the β configuration.

Cholesterol Is a Significant Constituent of Many Tissues

Cholesterol (Figure 21-20) is widely distributed in all cells of the body but particularly in nervous tissue. It is a major constituent of the plasma membrane and of plasma lipoproteins (see Chapter 26). It is often found as **cholesteryl ester**, where the hydroxyl group on position 3 is esterified with a long-chain fatty acid. It occurs in animals but not in plants or bacteria.

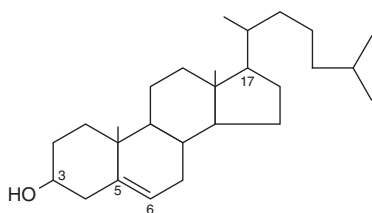

FIGURE 21-20 Cholesterol.

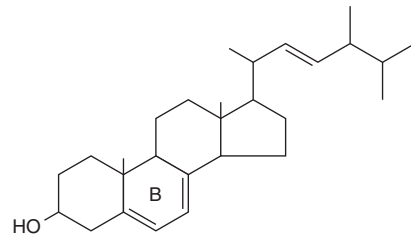

FIGURE 21-21 Ergosterol.

Ergosterol Is a Precursor of Vitamin D

Ergosterol occurs in plants and yeast and is important as a dietary source of vitamin D (Figure 21-21). When irradiated with ultraviolet light in the skin, ring B is opened to form vitamin D₂ in a process similar to the one that forms vitamin D₃ from 7-dehydro-cholesterol in the skin (see Figure 44-3).

Polyprenoids Share the Same Parent Compound as Cholesterol

Although not steroids, **polyprenoids** are related because they are synthesized, like cholesterol (see Figure 26-2), from five-carbon isoprene units (Figure 21-22). They include **ubiquinone** (see Chapter 13), which participates in the respiratory chain in mitochondria, and the long-chain alcohol **dolichol** (Figure 21-23), which takes part in glycoprotein synthesis by transferring carbohydrate residues to asparagine residues of the polypeptide (see Chapter 46). Plant-derived polyprenoids include rubber, camphor, the fat-soluble vitamins A, D, E, and K, and β -carotene (provitamin A).

LIPID PEROXIDATION IS A SOURCE OF FREE RADICALS

Peroxidation (**auto-oxidation**) of lipids exposed to oxygen is responsible not only for deterioration of foods (**rancidity**), but also for damage to tissues *in vivo*, where it may be a cause of cancer, inflammatory diseases, atherosclerosis, and aging. The deleterious effects are considered to be caused by **free radicals**, molecules that have unpaired valence electrons, making them highly reactive. Free radicals containing oxygen (eg, ROO \cdot , RO \cdot , OH \cdot) are termed **reactive oxygen species (ROS)**. These are produced during peroxide formation from fatty acids containing methylene-interrupted double bonds, that is,

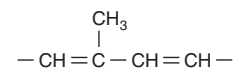

FIGURE 21-22 Isoprene unit.

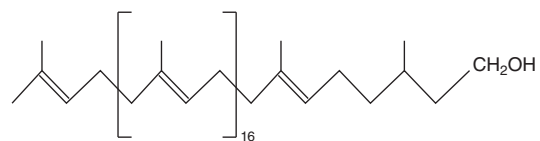

FIGURE 21-23 Dolichol—a C95 alcohol.

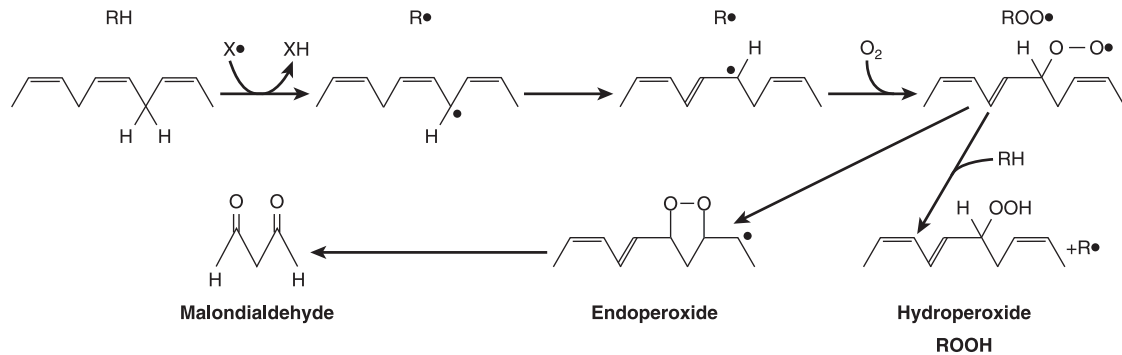
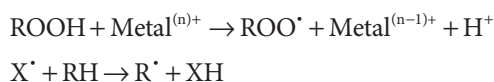

FIGURE 21–24 Lipid peroxidation. The reaction is initiated by an existing free radical (X[•]), by light, or by metal ions. Malondialdehyde is only formed by fatty acids with three or more double bonds and is used as a measure of lipid peroxidation together with ethane from the terminal two carbons of ω3 fatty acids and pentane from the terminal five carbons of ω6 fatty acids.

those found in the naturally occurring polyunsaturated fatty acids (Figure 21–24). **Lipid peroxidation** is a chain reaction providing a continuous supply of ROS that initiate further peroxidation and thus has potentially devastating effects. The whole process can be depicted as follows:

1. Initiation:



2. Propagation:

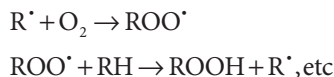

3. Termination:

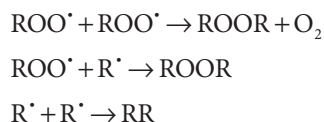

To control and reduce lipid peroxidation, both humans in their activities and nature invoke the use of **antioxidants**. Propyl gallate, butylated hydroxyanisole (BHA), and butylated hydroxytoluene (BHT) are antioxidants used as food additives. Naturally occurring antioxidants include vitamin E (tocopherol), which is lipid soluble, and urate and vitamin C, which are water soluble. Beta-carotene is an antioxidant at low PO_2 . Antioxidants fall into two classes: (1) **preventive antioxidants**, which reduce the rate of chain initiation and (2) **chain-breaking antioxidants**, which interfere with chain propagation. Preventive antioxidants include catalase and other peroxidases such as glutathione peroxidase (see Figure 20–3) that react with ROOH; selenium, which is an essential component of glutathione peroxidase and regulates its activity, and chelators of metal ions such as EDTA (ethylenediaminetetraacetate) and DTPA (diethylenetriaminepentaacetate). In vivo, the principal chain-breaking antioxidants are superoxide

dismutase, which acts in the aqueous phase to trap superoxide free radicals ($\text{O}_2^{\cdot -}$) urate, and vitamin E, which acts in the lipid phase to trap ROO[•] radicals (see Figure 44–6).

Peroxidation is also catalyzed *in vivo* by heme compounds and by **lipoxigenases** (see Figure 23–14) found in platelets and leukocytes. Other products of auto-oxidation or enzymic oxidation of physiologic significance include **oxysterols** (formed from cholesterol) and **isoprostanes** (formed from the peroxidation of polyunsaturated fatty acids such as arachidonic acid).

AMPHIPATHIC LIPIDS SELF-ORIENT AT OIL: WATER INTERFACES

They Form Membranes, Micelles, Liposomes, & Emulsions

In general, lipids are insoluble in water since they contain a predominance of nonpolar (hydrocarbon) groups. However, fatty acids, phospholipids, sphingolipids, bile salts, and, to a lesser extent, cholesterol contain polar groups. Therefore, a part of the molecule is **hydrophobic**, or water insoluble; and a part is **hydrophilic**, or water soluble. Such molecules are described as **amphipathic** (Figure 21–25). They become oriented at oil-water interfaces with the polar group in the water phase and the nonpolar group in the oil phase. A bilayer of such amphipathic lipids is the basic structure in biologic **membranes** (see Chapter 40). When a critical concentration of these lipids is present in an aqueous medium, they form **micelles**. **Liposomes** may be formed by sonicating an amphipathic lipid in an aqueous medium. They consist of spheres of lipid bilayers that enclose part of the aqueous medium. Aggregation of bile salts into micelles and liposomes and the formation of **mixed micelles** with the products of fat digestion are important in facilitating absorption of lipids from the intestine. Liposomes are of potential clinical use—particularly when combined with tissue-specific antibodies—as carriers of drugs in the

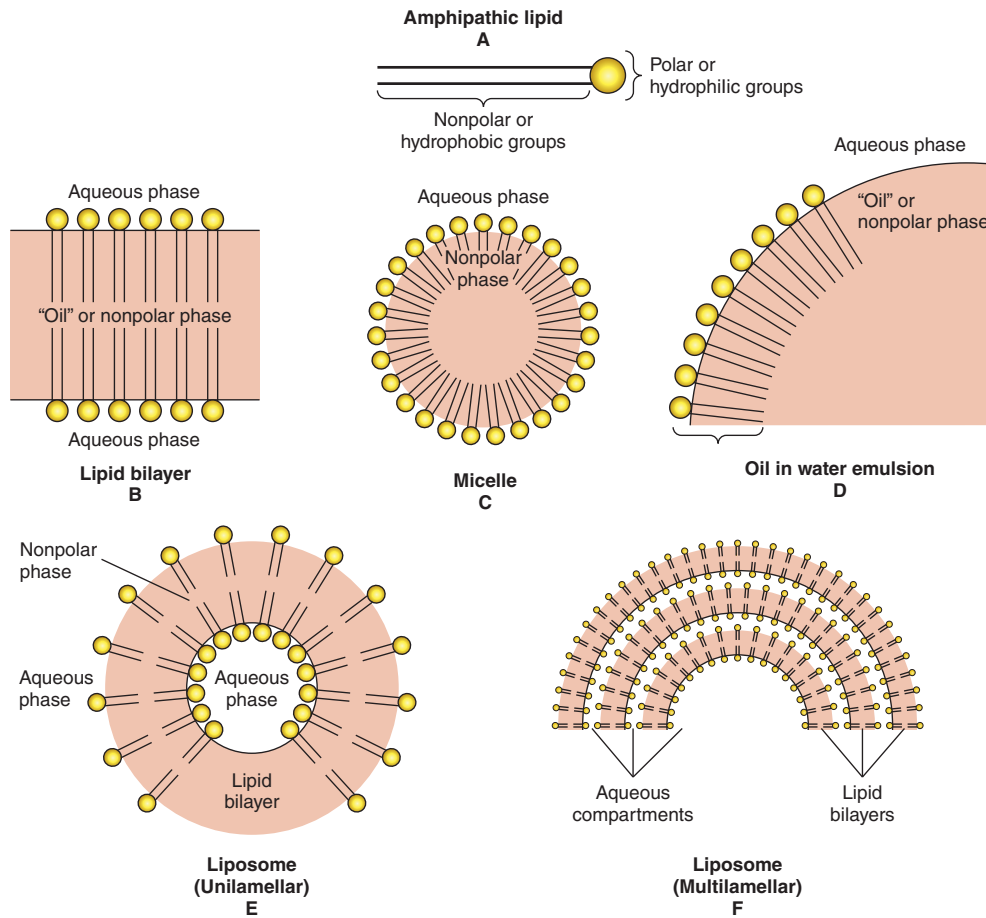

FIGURE 21–25 Formation of lipid membranes, micelles, emulsions, and liposomes from amphipathic lipids, for example, phospholipids.

circulation, targeted to specific organs, for example, in cancer therapy. In addition, they are used for gene transfer into vascular cells and as carriers for topical and transdermal delivery of drugs and cosmetics. **Emulsions** are much larger particles, formed usually by nonpolar lipids in an aqueous medium. These are stabilized by emulsifying agents such as amphipathic lipids (eg, phosphatidylcholine), which form a surface layer separating the main bulk of the nonpolar material from the aqueous phase (Figure 21–25).

SUMMARY

- Lipids have the common property of being relatively insoluble in water (hydrophobic) but soluble in nonpolar solvents. Amphipathic lipids also contain one or more polar groups, making them suitable as constituents of membranes at lipid-water interfaces.
- The lipids of major physiologic significance are fatty acids and their esters, together with cholesterol and other steroids.
- Long-chain fatty acids may be saturated, monounsaturated, or polyunsaturated, according to the number of double bonds present. Their fluidity decreases with chain length and increases according to degree of unsaturation.
- Eicosanoids are formed from 20-carbon polyunsaturated fatty acids and make up an important group of physiologically and pharmacologically active compounds known as prostaglandins, thromboxanes, leukotrienes, and lipoxins.
- The esters of glycerol are quantitatively the most significant lipids, represented by triacylglycerol ("fat"), a major constituent of some lipoprotein classes and the storage form of lipid in adipose tissue. Glycerophospholipids and sphingolipids are amphipathic lipids and have important roles—as major constituents of membranes and the outer layer of lipoproteins, as surfactant in the lung, as precursors of second messengers, and as constituents of nervous tissue.
- Glycolipids are also important constituents of nervous tissue such as brain and the outer leaflet of the cell membrane, where they contribute to the carbohydrates on the cell surface.
- Cholesterol, an amphipathic lipid, is an important component of membranes. It is the parent molecule from which all other steroids in the body, including major hormones such as the adrenocortical and sex hormones, D vitamins, and bile acids, are synthesized.
- Peroxidation of lipids containing polyunsaturated fatty acids leads to generation of free radicals that damage tissues and cause disease.

REFERENCES

- Christie WW: *Lipid Analysis*, 3rd ed. The Oily Press, 2003.
- Dessi M, Noce A, Bertucci P, et al: Atherosclerosis, dyslipidemia and inflammation: the significant role of polyunsaturated fatty acids. *ISRN Inflamm*, 2013;191:823.
- Dowhan W, Bodanov H, Mileykovskaya E: Functional roles of lipids in membranes. In: *Biochemistry of Lipids, Lipoproteins and Membranes*, 5th ed. Vance DE, Vance JE (editors). Elsevier, 2008:1–37.
- Gunstone FD, Harwood JL, Dijkstra AJ: *The Lipid Handbook with CD-Rom*. CRC Press, 2007.
- Gurr MI, Harwood JL, Frayn K: *Lipid Biochemistry*. Blackwell Publishing, 2002.
- Niki E, Yoshida Y, Saito Y, et al: Lipid peroxidation: mechanisms, inhibition and biological effects. *Biochem Biophys Res Commun*, 2005;338:668.
- Tur JA, Bibiloni MM, Sureda A, et al: Dietary sources of omega 3 fatty acids: public health risks and benefits. *Brit J Nutr* 2012;107(suppl 2):S23.

Oxidation of Fatty Acids: Ketogenesis

Kathleen M. Botham, PhD, DSc & Peter A. Mayes, PhD, DSc

OBJECTIVES

*After studying this chapter,
you should be able to:*

- Describe the processes by which fatty acids are transported in the blood and activated and transported into the matrix of the mitochondria for breakdown to obtain energy.
- Outline the β -oxidation pathway by which fatty acids are metabolized to acetyl-CoA and explain how this leads to the production of large quantities of ATP from the reducing equivalents produced during β -oxidation and further metabolism of the acetyl-CoA via the citric acid cycle.
- Identify the three compounds termed “ketone bodies” and describe the reactions by which they are formed in liver mitochondria.
- Appreciate that ketone bodies are important fuels for extrahepatic tissues and indicate the conditions in which their synthesis and use are favored.
- Indicate the three stages in the metabolism of fatty acids where ketogenesis is regulated.
- Understand that overproduction of ketone bodies leads to ketosis and, if prolonged, ketoacidosis, and identify pathological conditions when this occurs.
- Give examples of diseases associated with impaired fatty acid oxidation.

BIOMEDICAL IMPORTANCE

Although fatty acids are broken down by oxidation to acetyl-CoA and also synthesized from acetyl-CoA, fatty acid oxidation is not the simple reverse of fatty acid biosynthesis but an entirely different process taking place in a separate compartment of the cell. The separation of fatty acid oxidation in mitochondria from biosynthesis in the cytosol allows each process to be individually controlled and integrated with tissue requirements. Each step in fatty acid oxidation involves acyl-CoA derivatives, is catalyzed by separate enzymes, utilizes NAD^+ and FAD as coenzymes, and generates ATP. It is an aerobic process, requiring the presence of oxygen.

Increased fatty acid oxidation is a characteristic of starvation and of diabetes mellitus, and leads to increased **ketone body** production by the liver (**ketosis**). Ketone bodies are acidic and when produced in excess over long periods, as in diabetes, cause **ketoacidosis**, which is ultimately fatal. Because gluconeogenesis is dependent upon fatty acid oxidation, any impairment in fatty acid oxidation leads to

hypoglycemia. This occurs in various states of **carnitine deficiency** or deficiency of essential enzymes in fatty acid oxidation, for example, **carnitine palmitoyltransferase**, or inhibition of fatty acid oxidation by poisons, for example, **hypoglycin**.

OXIDATION OF FATTY ACIDS OCCURS IN MITOCHONDRIA

Fatty Acids Are Transported in the Blood as Free Fatty Acids

Free fatty acids (FFAs)—also called unesterified (UFA) or nonesterified (NEFA) fatty acids (Chapter 21)—are fatty acids that are in the **unesterified state**. In plasma, longer chain FFA are combined with **albumin**, and in the cell they are attached to a **fatty acid binding protein**, so that in fact they are never really “free.” Shorter chain fatty acids are more water-soluble and exist as the unionized acid or as a fatty acid anion.

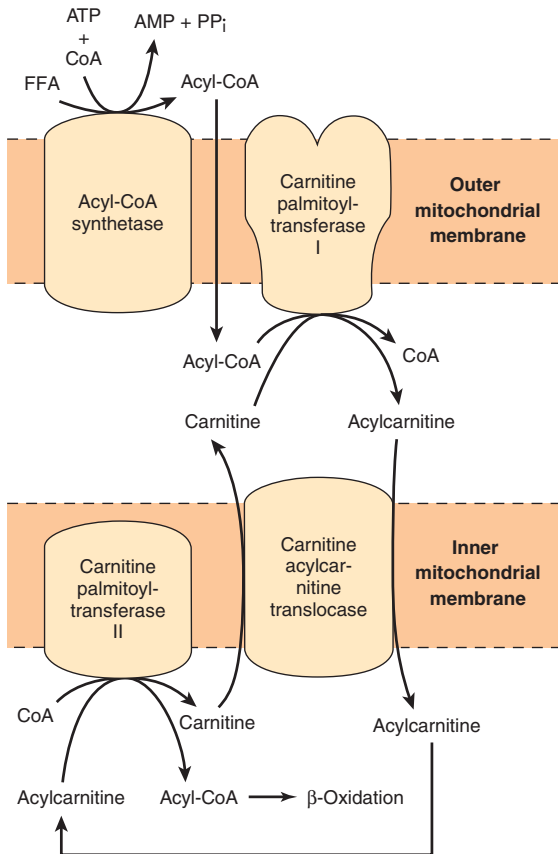

FIGURE 22-1 Role of carnitine in the transport of long-chain fatty acids through the inner mitochondrial membrane. Long-chain acyl-CoA enters the intermembrane space after its formation by acyl-CoA synthetase, but cannot pass through the inner mitochondrial membrane. For transport across the membrane, therefore, acyl groups are transferred from CoA to carnitine by carnitine palmitoyl transferase I (embedded in the outer mitochondrial membrane). The acylcarnitine formed can then be carried into the mitochondrial matrix by carnitine acylcarnitine translocase (embedded in the inner mitochondrial membrane) in exchange for a free carnitine. The acyl group is then transferred back to CoA by carnitine palmitoyl transferase II, reforming acyl-CoA, and the carnitine released is transported back into the intermembrane space via the translocase enzyme.

Fatty Acids Are Activated Before Being Catabolized

Fatty acids must first be converted to an active intermediate before they can be catabolized. This is the only step in the complete degradation of a fatty acid that requires energy from ATP. In the presence of ATP and coenzyme A, the enzyme **acyl-CoA synthetase (thiokinase)** catalyzes the conversion of a fatty acid (or FFA) to an “active fatty acid” or **acyl-CoA**, using one high-energy phosphate and forming AMP and PP_i (Figure 22-1). The PP_i is hydrolyzed by **inorganic pyrophosphatase** with the loss of a further high-energy phosphate, ensuring that the overall reaction goes to completion. Acyl-CoA synthetases are found in the endoplasmic reticulum, peroxisomes, and inside and on the outer membrane of mitochondria.

Long-Chain Fatty Acids Penetrate the Inner Mitochondrial Membrane as Carnitine Derivatives

Carnitine (β -hydroxy- γ -trimethylammonium butyrate), $(CH_3)_3 N^+ - CH_2 - CH(OH) - CH_2 - COO^-$, is widely distributed and is particularly abundant in muscle. Long-chain acyl-CoA (or FFA) cannot penetrate the inner membrane of mitochondria. In the presence of carnitine, however, **carnitine palmitoyltransferase-I**, located in the outer mitochondrial membrane, transfers long-chain acyl group from CoA to carnitine, forming **acylcarnitine** and releasing CoA. Acylcarnitine is able to penetrate the inner membrane and gain access to the β -oxidation system of enzymes via the inner membrane exchange transporter **carnitine-acylcarnitine translocase**. The transporter binds acylcarnitine and transports it across the membrane in exchange for carnitine. The acyl group is then transferred to CoA so that acyl-CoA is reformed and carnitine is liberated. This reaction is catalyzed by **carnitine palmitoyltransferase-II**, which is located on the inside of the inner membrane (Figure 22-1).

β -OXIDATION OF FATTY ACIDS INVOLVES SUCCESSIVE CLEAVAGE WITH RELEASE OF ACETYL-COA

In the **β -oxidation** (Figure 22-2) pathway, two carbons at a time are cleaved from acyl-CoA molecules, starting at the carboxyl end. The chain is broken between the $\alpha(2)$ - and $\beta(3)$ -carbon atoms—hence the name β -oxidation. The two-carbon units formed are acetyl-CoA; thus, palmitoyl-CoA forms eight acetyl-CoA molecules.

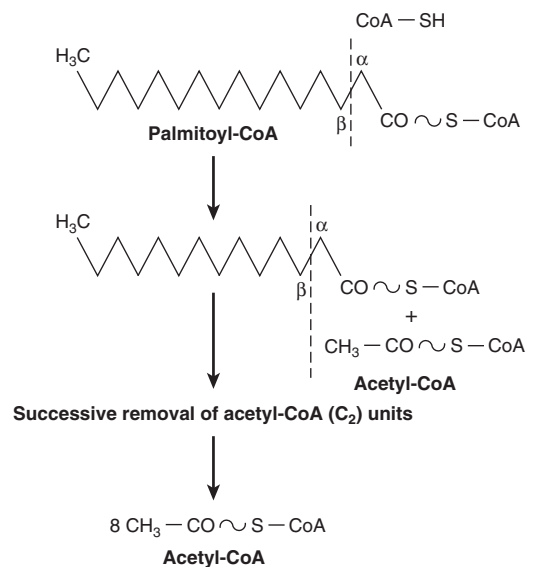

FIGURE 22-2 Overview of β -oxidation of fatty acids.

The β -Oxidation Cycle Generates FADH_2 & NADH

Several enzymes, known collectively as “fatty acid oxidase,” are found in the mitochondrial matrix or inner membrane adjacent to the respiratory chain. These catalyze the oxidation of acyl-CoA to acetyl-CoA via the β -oxidation pathway. The system proceeds in cyclic fashion which results in the degradation of long fatty acids to acetyl CoA. In the process, large quantities of the reducing equivalents FADH_2 and NADH are generated and are used to form ATP by oxidative phosphorylation (see Chapter 13) (Figure 22–3).

The first step is the removal of two hydrogen atoms from the 2(α)- and 3(β)-carbon atoms, catalyzed by **acyl-CoA dehydrogenase** and requiring FAD. This results in the formation of Δ^2 -*trans*-enoyl-CoA and FADH_2 . The reoxidation of FADH_2 by the respiratory chain requires the mediation of another flavoprotein, termed **electron-transferring flavoprotein** (see Chapter 12). Water is added to saturate the double bond and form 3-hydroxyacyl-CoA, catalyzed by Δ^2 -**enoyl-CoA hydratase**. The 3-hydroxy derivative undergoes further dehydrogenation on the 3-carbon catalyzed by **L(+)-3-hydroxyacyl-CoA dehydrogenase** to form the corresponding 3-ketoacyl-CoA compound. In this case, NAD^+ is the coenzyme involved. Finally, 3-ketoacyl-CoA is split at the 2,3-position by **thiolase** (3-ketoacyl-CoA-thiolase), forming acetyl-CoA and a new acyl-CoA two carbons shorter than the original acyl-CoA molecule. The shorter acyl-CoA formed in the cleavage reaction reenters the oxidative pathway at reaction 2 (Figure 22–3). In this way, a long-chain fatty acid with an even number of carbons may be degraded completely to acetyl-CoA (C_2 units). For example, after seven cycles, the C16 fatty acid, palmitate, would be converted to eight acetyl CoA molecules. Since acetyl-CoA can be oxidized to CO_2 and water via the citric acid cycle (which is also found within the mitochondria), the complete oxidation of fatty acids is achieved.

Oxidation of a Fatty Acid With an Odd Number of Carbon Atoms Yields Acetyl-CoA Plus a Molecule of Propionyl-CoA

Fatty acids with an odd number of carbon atoms are oxidized by the pathway of β -oxidation described above producing acetyl CoA until a three-carbon (propionyl-CoA) residue remains. This compound is converted to succinyl-CoA, a constituent of the citric acid cycle (see Figure 16–2). Hence, **the propionyl residue from an odd-chain fatty acid is the only part of a fatty acid that is glucogenic.**

Oxidation of Fatty Acids Produces a Large Quantity of ATP

Transport of electrons from FADH_2 and NADH via the respiratory chain leads to the synthesis of four high-energy phosphates (see Chapter 13) for each of the seven cycles needed for the breakdown of the C16 fatty acid, palmitate, to acetyl-CoA ($7 \times 4 = 28$). A total of 8 mol of acetyl-CoA is

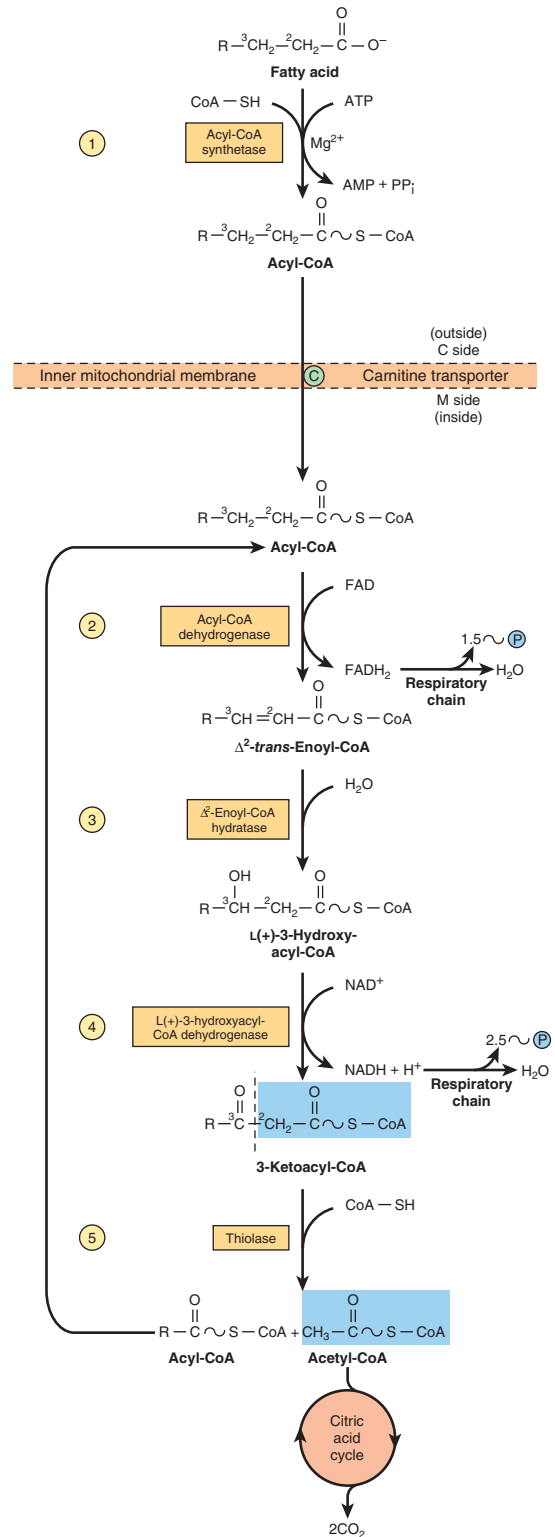

FIGURE 22–3 β -Oxidation of fatty acids. Long-chain acyl-CoA is cycled through reactions 2–5, acetyl-CoA being split off, each cycle, by thiolase (reaction 5). When the acyl radical is only four carbon atoms in length, two acetyl-CoA molecules are formed in reaction 5.

formed, and each gives rise to 10 mol of ATP on oxidation in the citric acid cycle, making $8 \times 10 = 80$ mol. Two must be subtracted for the initial activation of the fatty acid, yielding a net gain of 106 mol of ATP per mole of palmitate

TABLE 22-1 Generation of ATP From the Complete Oxidation of a C16 Fatty Acid

Step	Product	Amount Product Formed (mol)/mol Palmitate	ATP Formed (mol)/mol Product	Total ATP Formed (mol)/mol Palmitate	ATP Used (mol)/mol Palmitate
Activation		–			2
β -Oxidation	FADH ₂	7	1.5	10.5	–
β -Oxidation	NADH	7	2.5	17.5	–
Citric acid cycle	Acetyl CoA	8	10	80	–
Total ATP formed (mol)/mol palmitate				108	
Total ATP used (mol)/mol palmitate					2

The table shows how the oxidation of 1 mol of the C16 fatty acid, palmitate, generates 106 mol of ATP (108 formed in total—2 used in the activation step).

(Table 22-1), or $106 \times 30.5^* = 3233$ kJ. This represents 33% of the free energy of combustion of palmitic acid.

Peroxisomes Oxidize Very Long Chain Fatty Acids

A modified form of β -oxidation is found in **peroxisomes** and leads to the formation of acetyl-CoA and H₂O₂ (from the flavoprotein-linked dehydrogenase step), which is broken down by catalase (see Chapter 12). Thus, the dehydrogenation in peroxisomes is not linked directly to phosphorylation and the generation of ATP. The system facilitates the oxidation of **very long chain fatty acids** (eg, C₂₀, C₂₂). The enzymes responsible are induced by high-fat diets and in some species by hypolipidemic drugs such as clofibrate.

The enzymes in peroxisomes do not attack shorter chain fatty acids; the β -oxidation sequence ends at octanoyl-CoA. Octanoyl and acetyl groups are both further oxidized in mitochondria. Another role of peroxisomal β -oxidation is to shorten the side chain of cholesterol in bile acid formation (see Chapter 26). Peroxisomes also take part in the synthesis of ether glycerolipids (see Chapter 24), cholesterol, and dolichol (see Figure 26-2).

Oxidation of Unsaturated Fatty Acids Occurs by a Modified β -Oxidation Pathway

The CoA esters of unsaturated fatty acids are degraded by the enzymes normally responsible for β -oxidation until either a Δ^3 -*cis*-acyl-CoA compound or a Δ^4 -*cis*-acyl-CoA compound is formed, depending upon the position of the double bonds (Figure 22-4). The former compound is isomerized (Δ^3 -*cis* \rightarrow Δ^2 -*trans*-enoyl-CoA isomerase) to the corresponding Δ^2 -*trans*-CoA stage of β -oxidation for subsequent hydration and oxidation. Any Δ^4 -*cis*-acyl-CoA either remaining, as in the case of linoleic acid, or entering the pathway at this point after conversion by acyl-CoA dehydrogenase to Δ^2 -*trans*- Δ^4 -*cis*-dienoyl-CoA, is then metabolized as indicated in Figure 22-4.

* ΔG for the ATP reaction, as explained in Chapter 11.

KETOGENESIS OCCURS WHEN THERE IS A HIGH RATE OF FATTY-ACID OXIDATION IN THE LIVER

Under metabolic conditions associated with a high rate of fatty acid oxidation, the liver produces considerable quantities of **acetoacetate** and **D(-)-3-hydroxybutyrate** (β -hydroxybutyrate). Acetoacetate continually undergoes spontaneous decarboxylation to yield **acetone**. These three substances are collectively known as the **ketone bodies** (also called acetone bodies or [incorrectly*] “ketones”) (Figure 22-5). Acetoacetate and 3-hydroxybutyrate are interconverted by the mitochondrial enzyme **D(-)-3-hydroxybutyrate dehydrogenase**; the equilibrium is controlled by the mitochondrial $[\text{NAD}^+]/[\text{NADH}]$ ratio, that is, the **redox state**. The concentration of total ketone bodies in the blood of well-fed mammals does not normally exceed 0.2 mmol/L except in ruminants, where 3-hydroxybutyrate is formed continuously from butyric acid (a product of ruminal fermentation) in the rumen wall. In vivo, the liver appears to be the only organ in nonruminants to add significant quantities of ketone bodies to the blood. Extrahepatic tissues utilize acetoacetate and β -hydroxybutyrate as respiratory substrates. Acetone is a waste product which, as it is volatile, can be excreted via the lungs. Because there is active synthesis but little utilization of ketone bodies in the liver, while they are used but not produced in extrahepatic tissues, there is a net flow of the compounds to the extrahepatic tissues (Figure 22-6).

3-Hydroxy-3-Methylglutaryl-CoA (HMG-CoA) Is an Intermediate in the Pathway of Ketogenesis

Enzymes responsible for ketone body formation are associated mainly with the mitochondria. Two acetyl-CoA molecules formed in β -oxidation condense to form acetoacetyl-CoA by

*The term ketones should not be used as there are ketones in blood that are not ketone bodies, for example, pyruvate and fructose.

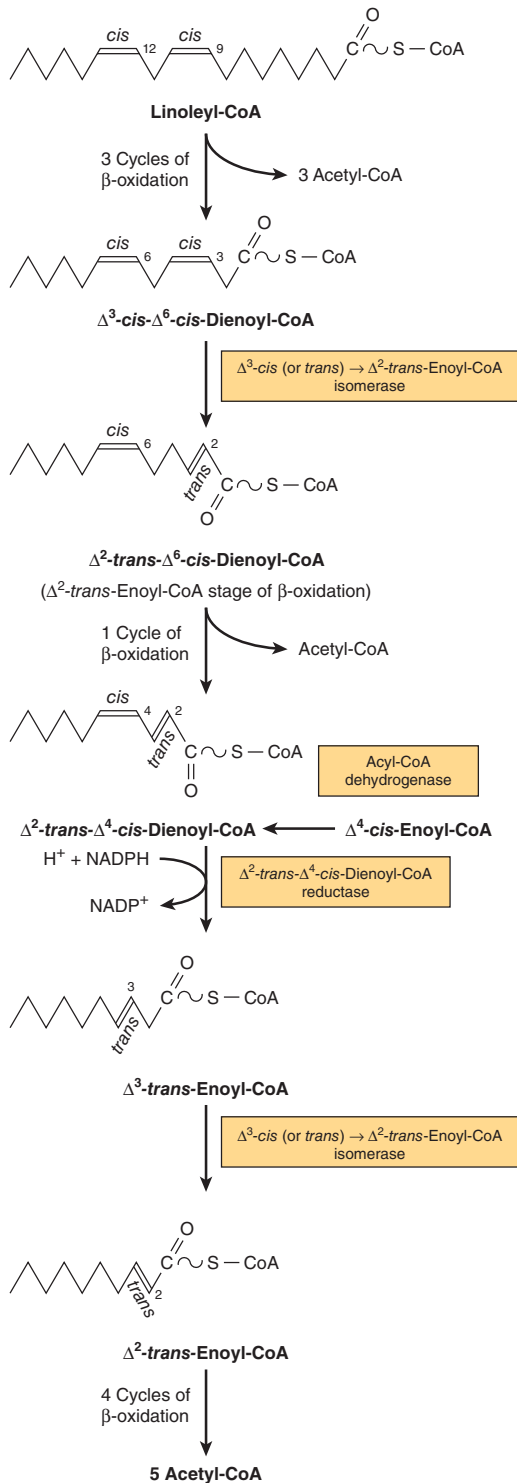

FIGURE 22-4 Sequence of reactions in the oxidation of unsaturated fatty acids, for example, linoleic acid. Δ^3 -cis-fatty acids or fatty acids forming Δ^4 -cis-enoyl-CoA enter the pathway at the position shown. NADPH for the dienoyl-CoA reductase step is supplied by intramitochondrial sources such as glutamate dehydrogenase, isocitrate dehydrogenase, and NAD(P)H transhydrogenase.

a reversal of the **thiolase** reaction. Acetoacetyl-CoA, which is the starting material for ketogenesis, also arises directly from the terminal four carbons of a fatty acid during β -oxidation (Figure 22-7). Condensation of acetoacetyl-CoA with another

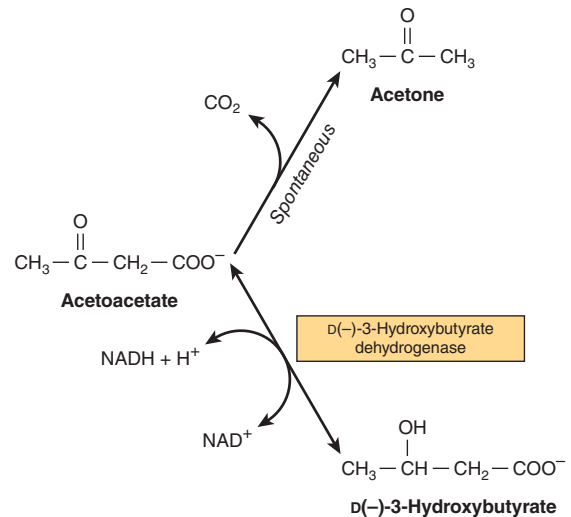

FIGURE 22-5 Interrelationships of the ketone bodies. D(-)-3-hydroxybutyrate dehydrogenase is a mitochondrial enzyme.

molecule of acetyl-CoA by **3-hydroxy-3-methylglutaryl-CoA synthase** forms 3-hydroxy-3-methylglutaryl-CoA (**HMG-CoA**). **3-Hydroxy-3-methylglutaryl-CoA lyase** then causes acetyl-CoA to split off from the HMG-CoA, leaving free acetoacetate. The carbon atoms split off in the acetyl-CoA molecule are derived from the original acetoacetyl-CoA molecule. **Both enzymes must be present in mitochondria for ketogenesis to take place.** This occurs solely in liver and rumen epithelium. D(-)-3-Hydroxybutyrate is quantitatively the predominant ketone body present in the blood and urine in ketosis.

Ketone Bodies Serve as a Fuel for Extrahepatic Tissues

While an active enzymatic mechanism produces acetoacetate from acetoacetyl-CoA in the liver, acetoacetate once formed cannot be reactivated directly except in the cytosol, where it is used in a much less active pathway as a precursor in cholesterol synthesis (Chapter 26). This accounts for the net production of ketone bodies by the liver.

In extrahepatic tissues, acetoacetate is activated to acetoacetyl-CoA by **succinyl-CoA-acetoacetate CoA transferase**. CoA is transferred from succinyl-CoA to form acetoacetyl-CoA (Figure 22-8). With the addition of a CoA, the acetoacetyl-CoA is split into two acetyl-CoAs by thiolase and oxidized in the citric acid cycle. If the blood level is raised, oxidation of ketone bodies increases until, at a concentration of ~ 12 mmol/L, the oxidative machinery is saturated. When this occurs, a large proportion of oxygen consumption may be accounted for by the oxidation of ketone bodies.

In most cases, **ketonemia is due to increased production of ketone bodies** by the liver rather than to a deficiency in their utilization by extrahepatic tissues. While acetoacetate and D(-)-3-hydroxybutyrate are readily oxidized by extrahepatic tissues, acetone is difficult to oxidize in vivo and to a large extent is volatilized in the lungs.

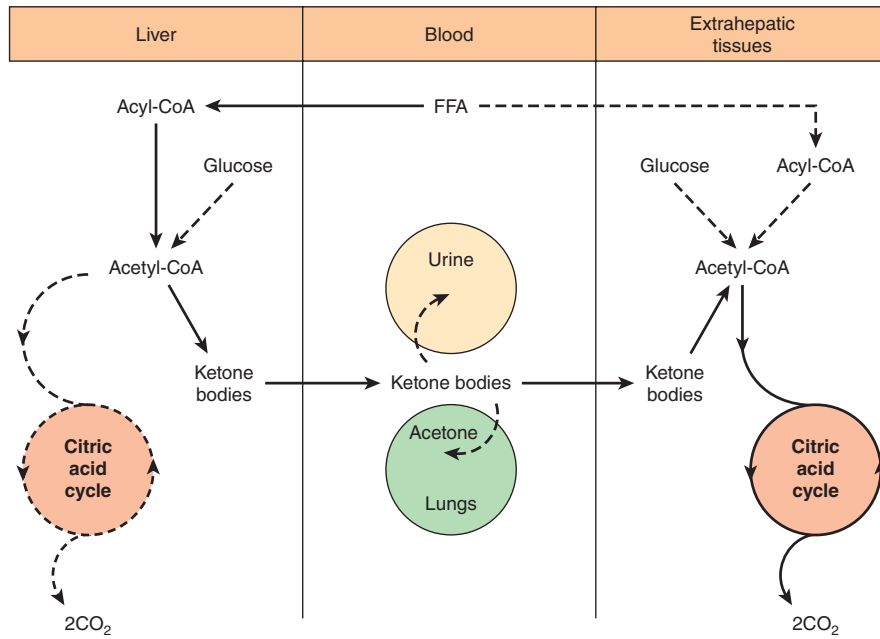

FIGURE 22-6 Formation, utilization, and excretion of ketone bodies. (The main pathway is indicated by the solid arrows.)

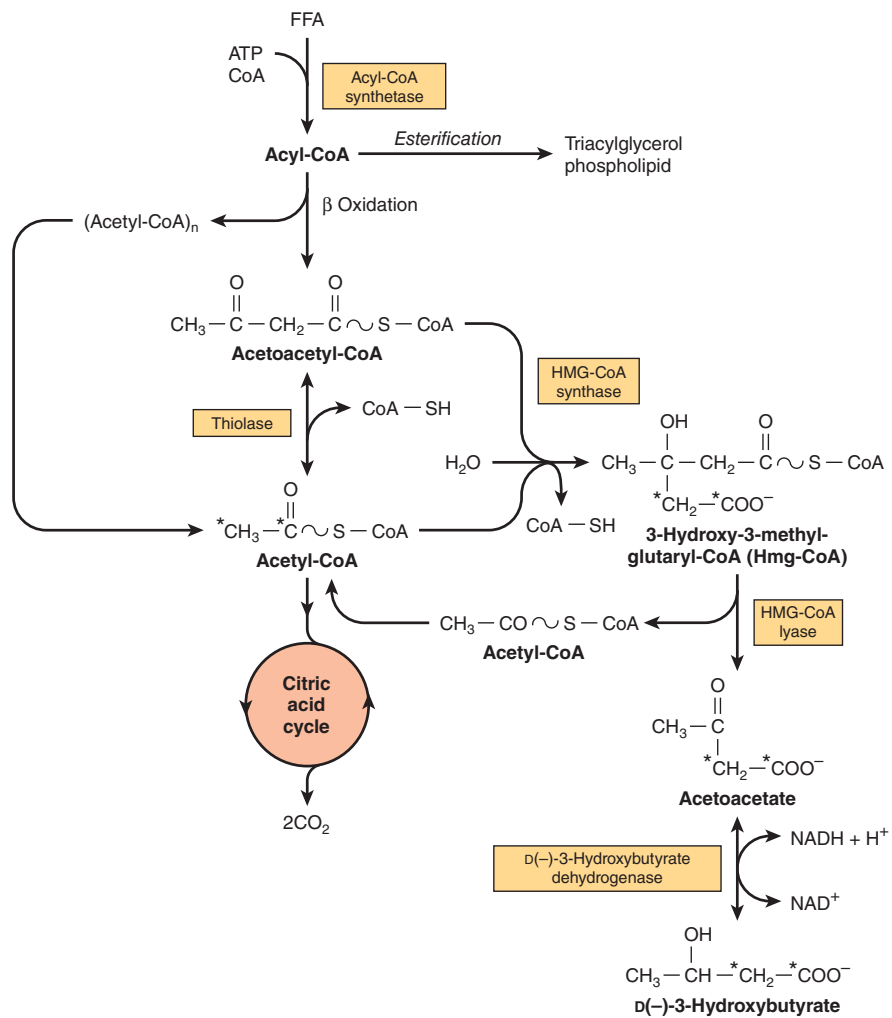

FIGURE 22-7 Pathways of ketogenesis in the liver. (FFA, free fatty acids.)

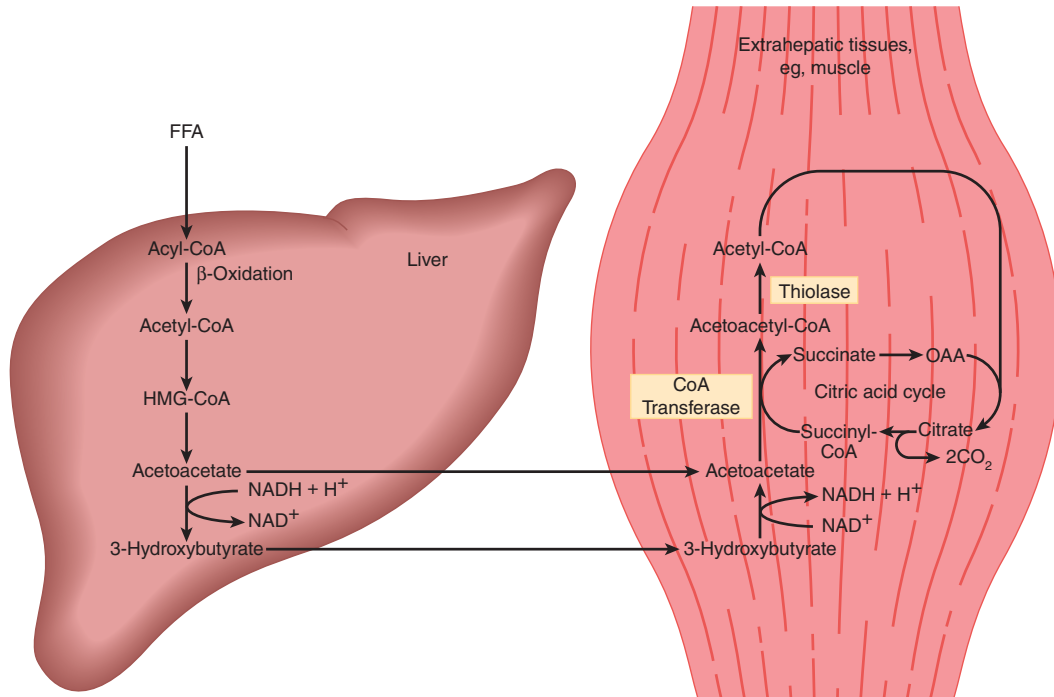

FIGURE 22-8 Transport of ketone bodies from the liver and pathways of utilization and oxidation in extrahepatic tissues.

In moderate ketonemia, the loss of ketone bodies via the urine is only a few percent of the total ketone body production and utilization. Since there are renal threshold-like effects (there is not a true threshold) that vary between species and individuals, measurement of the ketonemia, not the ketonuria, is the preferred method of assessing the severity of ketosis.

KETOGENESIS IS REGULATED AT THREE CRUCIAL STEPS

1. Ketosis does not occur in vivo unless there is an increase in the level of circulating FFAs that arise from lipolysis of triacylglycerol in adipose tissue. **FFAs are the precursors of ketone bodies in the liver.** The liver, both in fed and in fasting conditions, extracts ~30% of the FFAs passing through it, so that at high concentrations the flux passing into the liver is substantial. **Therefore, the factors regulating mobilization of FFA from adipose tissue are important in controlling ketogenesis** (Figures 22-9 and 25-8).
2. After uptake by the liver, FFAs are either **β-oxidized** to CO₂ or ketone bodies or **esterified** to triacylglycerol and phospholipid. There is regulation of entry of fatty acids into the oxidative pathway by **carnitine palmitoyltransferase-I (CPT-I)** (Figure 22-1), and the remainder of the fatty acid taken up is esterified. CPT-I activity is low in the fed state, leading to depression of fatty acid oxidation, and high in starvation, allowing fatty acid oxidation to increase.

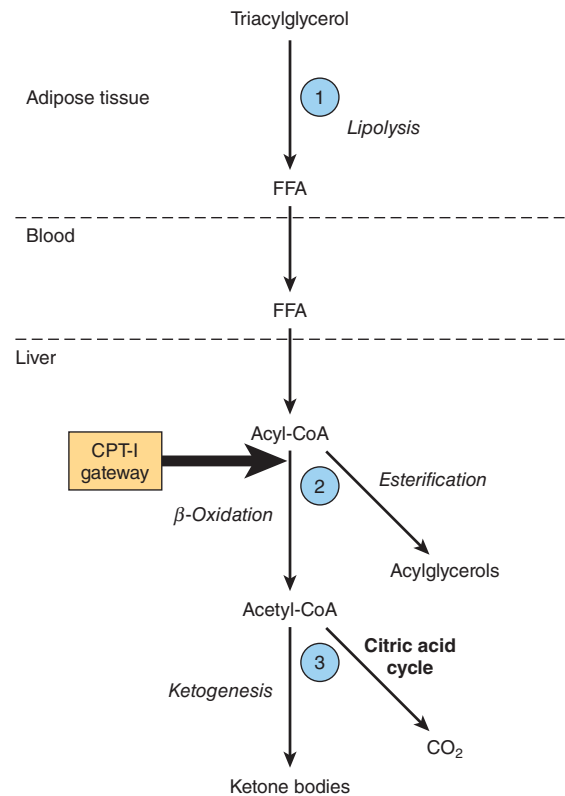

FIGURE 22-9 Regulation of ketogenesis. ① to ③ show three crucial steps in the pathway of metabolism of free fatty acids (FFA) that determine the magnitude of ketogenesis. (CPT-I, carnitine palmitoyltransferase-I.)

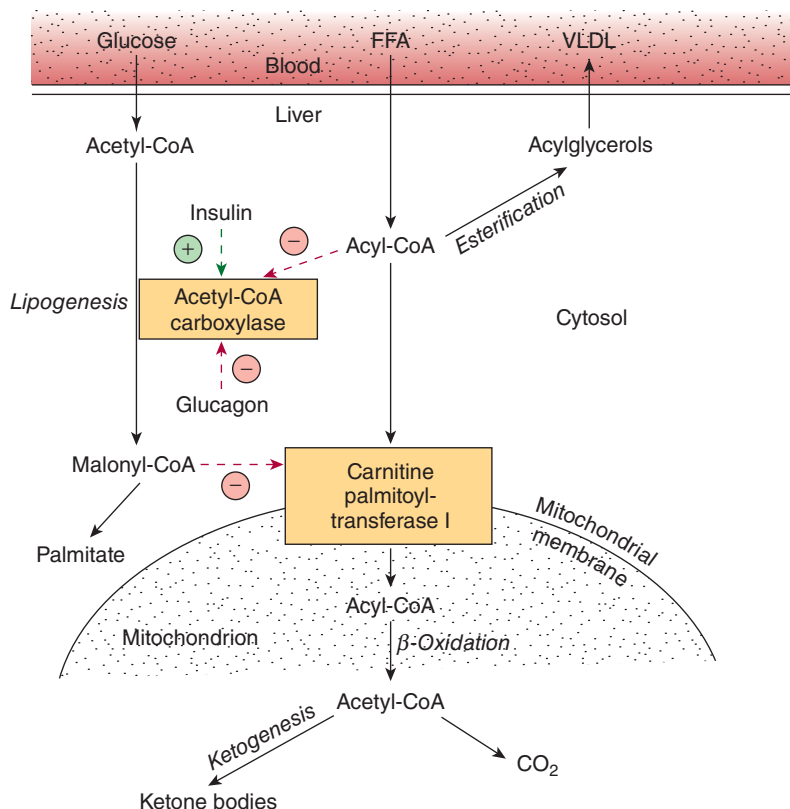

FIGURE 22-10 Regulation of long-chain fatty acid oxidation in the liver. (FFA, free fatty acids; VLDL, very low density lipoprotein.) Positive (⊕) and negative (⊖) regulatory effects are represented by broken arrows and substrate flow by solid arrows.

Malonyl-CoA, the initial intermediate in fatty acid biosynthesis (Figure 23-1) formed by acetyl-CoA carboxylase in the fed state, is a potent inhibitor of CPT-I (Figure 22-10). Under these conditions, FFA enter the liver cell in low concentrations and are nearly all esterified to acylglycerols and transported out of the liver in **very low density lipoproteins** (VLDL). However, as the concentration of FFA increases with the onset of starvation, acetyl-CoA carboxylase is inhibited directly by acyl-CoA, and (malonyl-CoA) decreases, releasing the inhibition of CPT-I and allowing more acyl-CoA to be β -oxidized. These events are reinforced in starvation by a decrease in the (**insulin**)/(**glucagon**) ratio. Thus, β -oxidation from FFA is controlled by the CPT-I gateway into the mitochondria, and the balance of the FFA uptake not oxidized is esterified.

- In turn, the acetyl-CoA formed in β -oxidation is oxidized in the citric acid cycle, or it enters the pathway of ketogenesis to form ketone bodies. As the level of serum FFA is raised, proportionately more FFA is converted to ketone bodies and less is oxidized via the citric acid cycle to CO_2 . The partition of acetyl-CoA between the ketogenic pathway and the pathway of oxidation to CO_2 is regulated so that the total free energy captured in ATP which results from the oxidation of FFA remains constant as their concentration in the serum changes. This may be appreciated

when it is realized that complete oxidation of 1 mol of palmitate involves a net production of 106 mol of ATP via β -oxidation and CO_2 production in the citric acid cycle (see above), whereas only 26 mol of ATP are produced when acetoacetate is the end product and only 21 mol when 3-hydroxybutyrate is the end product. Thus, ketogenesis may be regarded as a mechanism that allows the liver to oxidize increasing quantities of fatty acids within the constraints of a tightly coupled system of oxidative phosphorylation.

A fall in the concentration of oxaloacetate, particularly within the mitochondria, can impair the ability of the citric acid cycle to metabolize acetyl-CoA and divert fatty acid oxidation toward ketogenesis. Such a fall may occur because of an increase in the (NADH)/(NAD⁺) ratio caused by increased β -oxidation of fatty acids affecting the equilibrium between oxaloacetate and malate, leading to a decrease in the concentration of oxaloacetate, and when gluconeogenesis is elevated, which occurs when blood glucose levels are low. The activation of pyruvate carboxylase, which catalyzes the conversion of pyruvate to oxaloacetate, by acetyl-CoA partially alleviates this problem, but in conditions such as starvation and untreated diabetes mellitus, ketone bodies are overproduced causing ketosis.

CLINICAL ASPECTS

Impaired Oxidation of Fatty Acids Gives Rise to Diseases Often Associated With Hypoglycemia

Carnitine deficiency can occur particularly in the newborn—and especially in preterm infants—owing to inadequate biosynthesis or renal leakage. Losses can also occur in hemodialysis. This suggests a vitamin-like dietary requirement for carnitine in some individuals. Symptoms of deficiency include hypoglycemia, which is a consequence of impaired fatty acid oxidation and lipid accumulation with muscular weakness. Treatment is by oral supplementation with carnitine.

Inherited **CPT-I deficiency** affects only the liver, resulting in reduced fatty acid oxidation and ketogenesis, with hypoglycemia. **CPT-II deficiency** affects primarily skeletal muscle and, when severe, the liver. The sulfonylurea drugs (**glyburide** [**glibenclamide**] and **tolbutamide**), used in the treatment of type 2 diabetes mellitus, reduce fatty acid oxidation and, therefore, hyperglycemia by inhibiting CPT-I.

Inherited defects in the enzymes of β -oxidation and ketogenesis also lead to nonketotic hypoglycemia, coma, and fatty liver. Defects are known in long- and short-chain 3-hydroxyacyl-CoA dehydrogenase (deficiency of the long-chain enzyme may be a cause of **acute fatty liver of pregnancy**). **3-Ketoacyl-CoA thiolase** and **HMG-CoA lyase deficiency** also affect the degradation of leucine, a ketogenic amino acid (Chapter 29).

Jamaican vomiting sickness is caused by eating the unripe fruit of the akee tree, which contains the toxin **hypoglycin**. This inactivates medium- and short-chain acyl-CoA dehydrogenase, inhibiting β -oxidation and causing hypoglycemia. **Dicarboxylic aciduria** is characterized by the excretion of C_6 — C_{10} ω -dicarboxylic acids and by nonketotic hypoglycemia, and is caused by a lack of mitochondrial **medium-chain acyl-CoA dehydrogenase**. **Refsum disease** is a rare neurologic disorder due to a metabolic defect that results in the accumulation of phytanic acid, which is found in dairy products and ruminant fat and meat. Phytanic acid is thought to have pathological effects on membrane function, protein prenylation, and gene expression. **Zellweger (cerebrohepato renal) syndrome** occurs in individuals with a rare inherited absence of peroxisomes in all tissues. They accumulate C_{26} — C_{38} polyenoic acids in brain tissue and also exhibit a generalized loss of peroxisomal functions. The disease causes severe neurological symptoms, and most patients die in the first year of life.

Ketoacidosis Results From Prolonged Ketosis

Higher than normal quantities of ketone bodies present in the blood or urine constitute **ketonemia** (hyperketonemia) or **ketonuria**, respectively. The overall condition is called **ketosis**. The basic form of ketosis occurs in **starvation** and involves depletion of available carbohydrate coupled with mobilization of FFA. This general pattern of metabolism is exaggerated to

produce the pathologic states found in **diabetes mellitus, the type 2 form of which is increasingly common in Western countries; twin lamb disease; and ketosis in lactating cattle**. Nonpathologic forms of ketosis are found under conditions of high-fat feeding and after severe exercise in the postabsorptive state.

Acetoacetic and 3-hydroxybutyric acids are both moderately strong acids and are buffered when present in blood or other tissues. However, their continual excretion in quantity progressively depletes the alkali reserve, causing **ketoacidosis**. This may be fatal in uncontrolled **diabetes mellitus**.

SUMMARY

- Fatty acid oxidation in mitochondria leads to the generation of large quantities of ATP by a process called β -oxidation that cleaves acetyl-CoA units sequentially from fatty acyl chains. The acetyl-CoA is oxidized in the citric acid cycle, generating further ATP.
- The ketone bodies (acetoacetate, 3-hydroxybutyrate, and acetone) are formed in hepatic mitochondria when there is a high rate of fatty acid oxidation. The pathway of ketogenesis involves synthesis and breakdown of 3-hydroxy-3-methylglutaryl-CoA (HMG-CoA) by two key enzymes, HMG-CoA synthase, and HMG-CoA lyase.
- Ketone bodies are important fuels in extrahepatic tissues.
- Ketogenesis is regulated at three crucial steps: (1) control of FFA mobilization from adipose tissue; (2) the activity of carnitine palmitoyltransferase-I in liver, which determines the proportion of the fatty acid flux that is oxidized rather than esterified; and (3) partition of acetyl-CoA between the pathway of ketogenesis and the citric acid cycle.
- Diseases associated with impairment of fatty acid oxidation lead to hypoglycemia, fatty infiltration of organs, and hypoketonemia.
- Ketosis is mild in starvation but severe in diabetes mellitus and ruminant ketosis.

REFERENCES

- Eaton S, Bartlett K, Pourfarzam M: Mammalian mitochondrial β -oxidation. *Biochem J* 1996;320:345.
- Fukao T, Lopaschuk GD, Mitchell GA: Pathways and control of ketone body metabolism: on the fringe of lipid metabolism. *Prostaglandins Leukot Essent Fatty Acids* 2004;70:243.
- Gurr MI, Harwood JL, Frayn K: *Lipid Biochemistry*. Blackwell Publishing, 2002.
- Houten SM, Wanders RJA: A general introduction to the biochemistry of mitochondrial fatty acid β -oxidation. *J Inher Metab Dis* 2010;33:469.
- Scriver CR, Beaudet AL, Sly WS, et al (editors): *The Metabolic and Molecular Bases of Inherited Disease*, 8th ed. McGraw-Hill, 2001.
- Van Veldhoven PP: Biochemistry and genetics of inherited disorders of peroxisomal fatty acid metabolism. *J Lipid Res* 2010;51:2863.
- Wood PA: Defects in mitochondrial beta-oxidation of fatty acids. *Curr Opin Lipidol* 1999;10:107.

Biosynthesis of Fatty Acids & Eicosanoids

Kathleen M. Botham, PhD, DSc & Peter A. Mayes, PhD, DSc

OBJECTIVES

After studying this chapter, you should be able to:

- Describe the reaction catalyzed by acetyl-CoA carboxylase and understand the mechanisms by which its activity is regulated to control the rate of fatty acid synthesis.
- Outline the structure of the fatty acid synthase multienzyme complex, indicating the sequence of enzymes in the two peptide chains of the homodimer.
- Explain how long-chain fatty acids are synthesized by the repeated condensation of two carbon units, with formation of the 16-carbon palmitate being favored in most tissues, and identify the cofactors required.
- Indicate the sources of reducing equivalents (NADPH) for fatty acid synthesis.
- Understand how fatty acid synthesis is regulated by nutritional status and identify other control mechanisms that operate in addition to modulation of the activity of acetyl-CoA carboxylase.
- Identify the nutritionally essential fatty acids and explain why they cannot be formed in the body.
- Explain how polyunsaturated fatty acids are synthesized by desaturase and elongation enzymes.
- Outline the cyclooxygenase and lipoxygenase pathways responsible for the formation of the various classes of eicosanoids.

BIOMEDICAL IMPORTANCE

Fatty acids are synthesized by an **extramitochondrial system**, which is responsible for the complete synthesis of palmitate from acetyl-CoA in the **cytosol**. In most mammals, glucose is the primary substrate for lipogenesis, but in ruminants it is acetate, the main fuel molecule they obtain from the diet. Critical diseases of the pathway have not been reported in humans. However, inhibition of lipogenesis occurs in type 1 (insulin-dependent) **diabetes mellitus**, and variations in the activity of the process affect the nature and extent of **obesity**.

Unsaturated fatty acids in phospholipids of the cell membrane are important in maintaining membrane fluidity (see Chapter 40). A high ratio of polyunsaturated fatty acids to saturated fatty acids (P:S ratio) in the diet is considered to be beneficial in preventing coronary heart disease. Animal tissues have limited capacity for desaturating fatty acids, and require certain dietary polyunsaturated fatty acids derived from plants. These **essential fatty acids** are used to form eicosanoic (C_{20})

fatty acids, which give rise to the **eicosanoids** prostaglandins, thromboxanes, leukotrienes, and lipoxins. Prostaglandins mediate **inflammation, pain**, and induce **sleep** and also regulate **blood coagulation** and **reproduction**. **Nonsteroidal anti-inflammatory drugs (NSAIDs)** such as **aspirin and ibuprofen** act by inhibiting prostaglandin synthesis. Leukotrienes have muscle contractant and chemotactic properties and are important in allergic reactions and inflammation.

THE MAIN PATHWAY FOR DE NOVO SYNTHESIS OF FATTY ACIDS (LIPOGENESIS) OCCURS IN THE CYTOSOL

This system is present in many tissues, including liver, kidney, brain, lung, mammary gland, and adipose tissue. Its cofactor requirements include NADPH, ATP, Mn^{2+} , biotin,

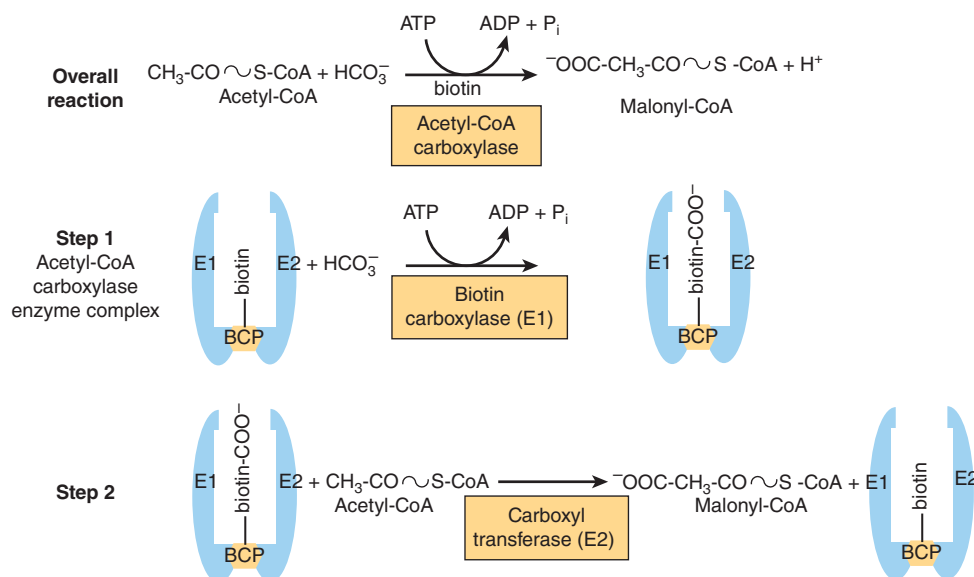

FIGURE 23-1 Biosynthesis of malonyl-CoA by acetyl carboxylase. Acetyl carboxylase is a multienzyme complex containing two enzymes, biotin carboxylase (E1) and a carboxyltransferase (E2) and the biotin carrier protein (BCP). Biotin is covalently linked to the BCP. The reaction proceeds in 2 steps. In step 1, catalyzed by E1, biotin is carboxylated as it accepts a CO_3^- group from HCO_3^- and ATP is used. In step 2, catalyzed by E2, the COO^- is transferred to acetyl-CoA forming malonyl-CoA.

and HCO_3^- (as a source of CO_2). **Acetyl-CoA** is the immediate substrate, and **free palmitate** is the end product.

Production of Malonyl-CoA Is the Initial & Controlling Step in Fatty Acid Synthesis

Bicarbonate as a source of CO_2 is required in the initial reaction for the carboxylation of acetyl-CoA to **malonyl-CoA** in the presence of ATP and **acetyl-CoA carboxylase**. This enzyme has a major role in the regulation of fatty acid synthesis (see below). Acetyl-CoA carboxylase has a requirement for the B vitamin **biotin** and is a **multienzyme protein** containing biotin, biotin carboxylase, biotin carboxyl carrier protein, and a carboxyl transferase, as well as a regulatory allosteric site. One subunit of the complex contains all the components, and variable number of subunits form polymers in the active enzyme (see Figure 23-6). The reaction takes place in two steps: (1) carboxylation of biotin involving ATP and (2) transfer of the carboxyl group to acetyl-CoA to form malonyl-CoA (Figure 23-1).

The Fatty Acid Synthase Complex Is a Homodimer of Two Polypeptide Chains Containing Six Enzyme Activities

After the formation of malonyl-CoA, fatty acids are formed by the **fatty acid synthase enzyme complex**. The individual enzymes required for fatty acid synthesis are linked in this multienzyme polypeptide complex that incorporates the **acyl carrier protein (ACP)**, which has a similar function to CoA in the β -oxidation pathway (see Chapter 22) It contains the vitamin **pantothenic acid** in the form of 4'-phosphopantetheine (see Figure 44-18). In the primary structure of the protein,

the enzyme domains are linked in the sequence as shown in **Figure 23-2**. X-ray crystallography of the three-dimensional structure, however, has shown that the complex is a homodimer, with two identical subunits, each containing 6 enzymes and an ACP, arranged in an X shape (Figure 23-2). The position of the ACP and thioesterase domains cannot be resolved as yet by x-ray crystallography, possibly because they are too flexible, but they are thought to lie close to the 3-ketoacylreductase enzyme. The use of one multienzyme functional unit has the advantages of achieving the effect of compartmentalization of the process within the cell without the erection of permeability barriers, and synthesis of all enzymes in the complex is coordinated since it is encoded by a single gene.

Initially, a priming molecule of acetyl-CoA combines with a cysteine -SH group (**Figure 23-3**, reaction 1a), while malonyl-CoA combines with the adjacent -SH on the 4'-phosphopantetheine of ACP of the other monomer (reaction 1b). These reactions are catalyzed by **malonyl acetyl transacylase**, to form **acetyl (acyl)-malonyl enzyme**. The acetyl group attacks the methylene group of the malonyl residue, catalyzed by **3-ketoacyl synthase**, and liberates CO_2 , forming 3-ketoacyl enzyme (acetoacetyl enzyme) (reaction 2), freeing the cysteine -SH group. Decarboxylation allows the reaction to go to completion, pulling the whole sequence of reactions in the forward direction. The 3-ketoacyl group is reduced, dehydrated, and reduced again (reactions 3-5) to form the corresponding saturated acyl-S-enzyme. A new malonyl-CoA molecule combines with the -SH of 4'-phosphopantetheine, displacing the saturated acyl residue onto the free cysteine -SH group. The sequence of reactions is repeated six more times until a saturated 16-carbon acyl radical (palmitoyl) has been assembled. It is liberated from the enzyme complex by the activity

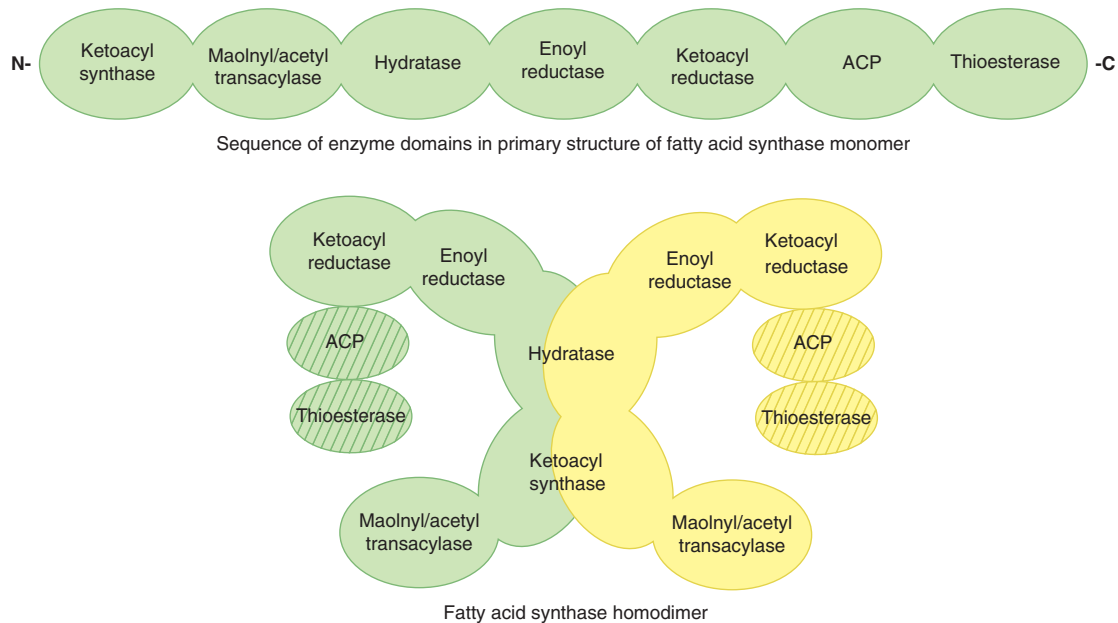
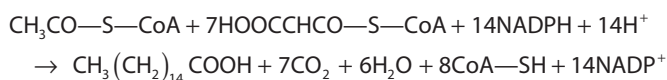

FIGURE 23-2 Fatty acid synthase multienzyme complex. The complex is a dimer of two identical polypeptide monomers in which six enzymes and the acyl carrier protein (ACP) are linked in the primary structure in the sequence shown. X-ray crystallography of the three-dimensional structure has demonstrated that the two monomers in the complex are arranged in an X-shape. The position of the ACP and thioesterase is not yet resolved, but they are thought to be close to the 3 ketoacyl reductase enzyme domain.

of the sixth enzyme in the complex, **thioesterase** (deacylase). The free palmitate must be activated to acyl-CoA before it can proceed via any other metabolic pathway. Its possible fates are esterification into acylglycerols, chain elongation or desaturation, or esterification into cholesteryl ester. In mammary gland, there is a separate thioesterase specific for acyl residues of C_8 , C_{10} , or C_{12} , which are subsequently found in milk lipids.

The equation for the overall synthesis of palmitate from acetyl-CoA and malonyl-CoA is



The acetyl-CoA used as a primer forms carbon atoms 15 and 16 of palmitate. The addition of all the subsequent C_2 units is via malonyl-CoA. Propionyl CoA acts as primer for the synthesis of long-chain fatty acids having an odd number of carbon atoms, found particularly in ruminant fat and milk.

The Main Source of NADPH for Lipogenesis Is the Pentose Phosphate Pathway

NADPH is involved as a donor of reducing equivalents in both the reduction of the 3-ketoacyl and of the 2,3-unsaturated acyl derivatives (Figure 23-3, reactions 3 and 5). The oxidative reactions of the pentose phosphate pathway (see Chapter 20) are the chief source of the hydrogen required for the reductive synthesis of fatty acids. Significantly, tissues specializing in active lipogenesis—ie, liver, adipose tissue, and the lactating mammary gland—also possess an active pentose phosphate pathway. Moreover, both

metabolic pathways are found in the cytosol of the cell; so, there are no membranes or permeability barriers against the transfer of NADPH. Other sources of NADPH include the reaction that converts malate to pyruvate catalyzed by the “**malic enzyme**” (NADP malate dehydrogenase) (Figure 23-4) and the extramitochondrial **isocitrate dehydrogenase** reaction (probably not a substantial source, except in ruminants).

Acetyl-CoA Is the Principal Building Block of Fatty Acids

Acetyl-CoA is formed from glucose via the oxidation of pyruvate in the matrix of the mitochondria. However, as it does not diffuse readily across the mitochondrial membranes, its transport into the cytosol, the principal site of fatty acid synthesis, requires a special mechanism involving **citrate**. After condensation of acetyl-CoA with oxaloacetate in the citric acid cycle within mitochondria, the citrate produced can be translocated into the extramitochondrial compartment via the tricarboxylate transporter, where in the presence of CoA and ATP, it undergoes cleavage to acetyl-CoA and oxaloacetate catalyzed by **ATP-citrate lyase**, which increases in activity in the well-fed state. The acetyl-CoA is then available for malonyl-CoA formation and synthesis of fatty acids (Figure 23-4). The resulting oxaloacetate can form malate via NADH-linked malate dehydrogenase, followed by the generation of NADPH via the malic enzyme. The NADPH becomes available for lipogenesis, and the pyruvate can be used to regenerate acetyl-CoA after transport into the mitochondrion. This pathway is a means of transferring reducing equivalents from extramitochondrial NADH to NADP. Alternatively, malate itself can be transported into

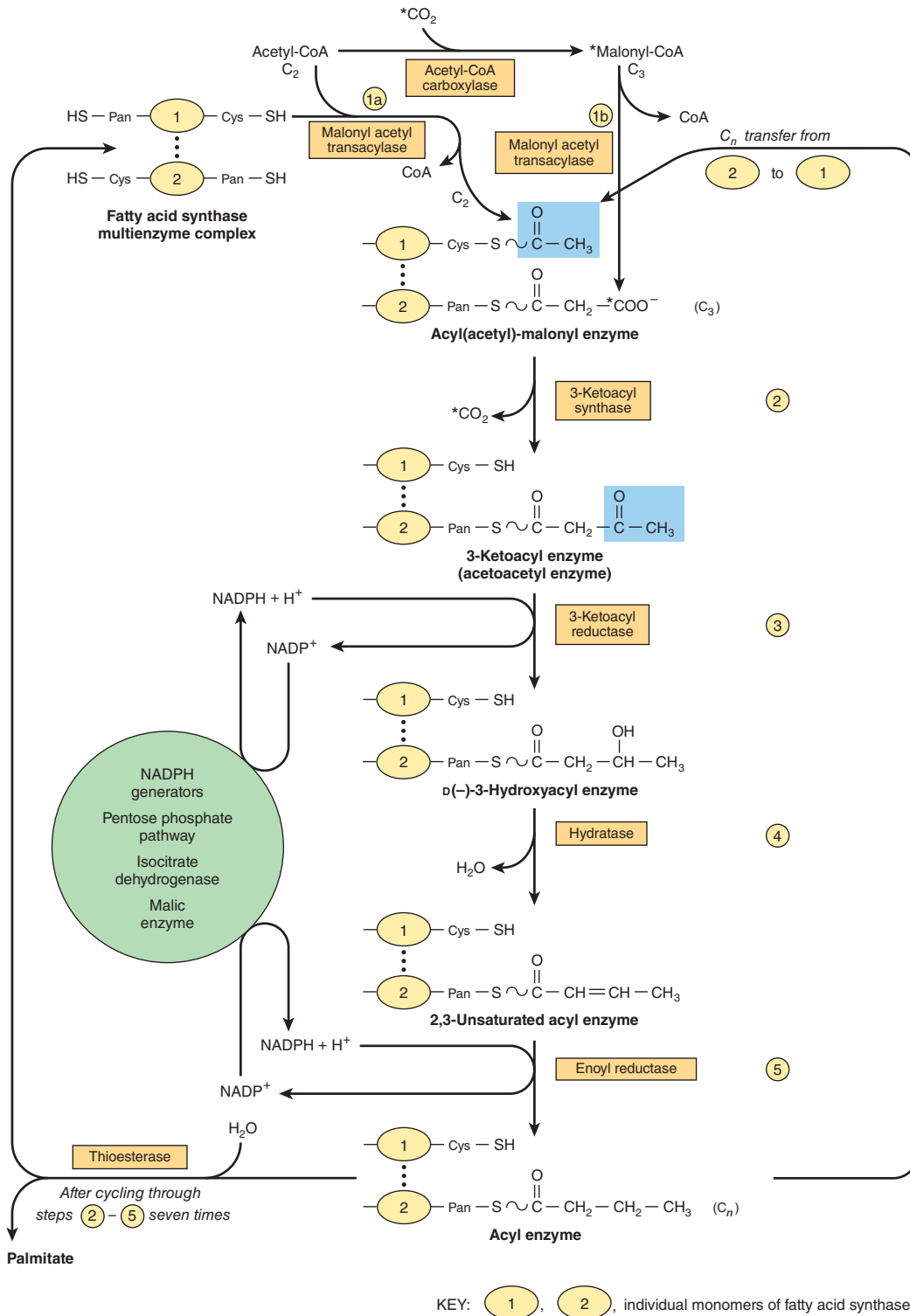

FIGURE 23-3 Biosynthesis of long-chain fatty acids. Details of how addition of a malonyl residue causes the acyl chain to grow by two carbon atoms. (Cys, cysteine residue; Pan, 4'-phosphopantetheine.) The blocks highlighted in blue contain initially a C₂ unit derived from acetyl-CoA (as illustrated) and subsequently the C_n unit formed in reaction 5.

the mitochondrion, where it is able to re-form oxaloacetate. Note that the citrate (tricarboxylate) transporter in the mitochondrial membrane requires malate to exchange with citrate (see Figure 13-10). There is little ATP-citrate lyase

or malic enzyme in ruminants, probably because in these species acetate (derived from carbohydrate digestion in the rumen and activated to acetyl-CoA extramitochondrially) is the main source of acetyl-CoA.

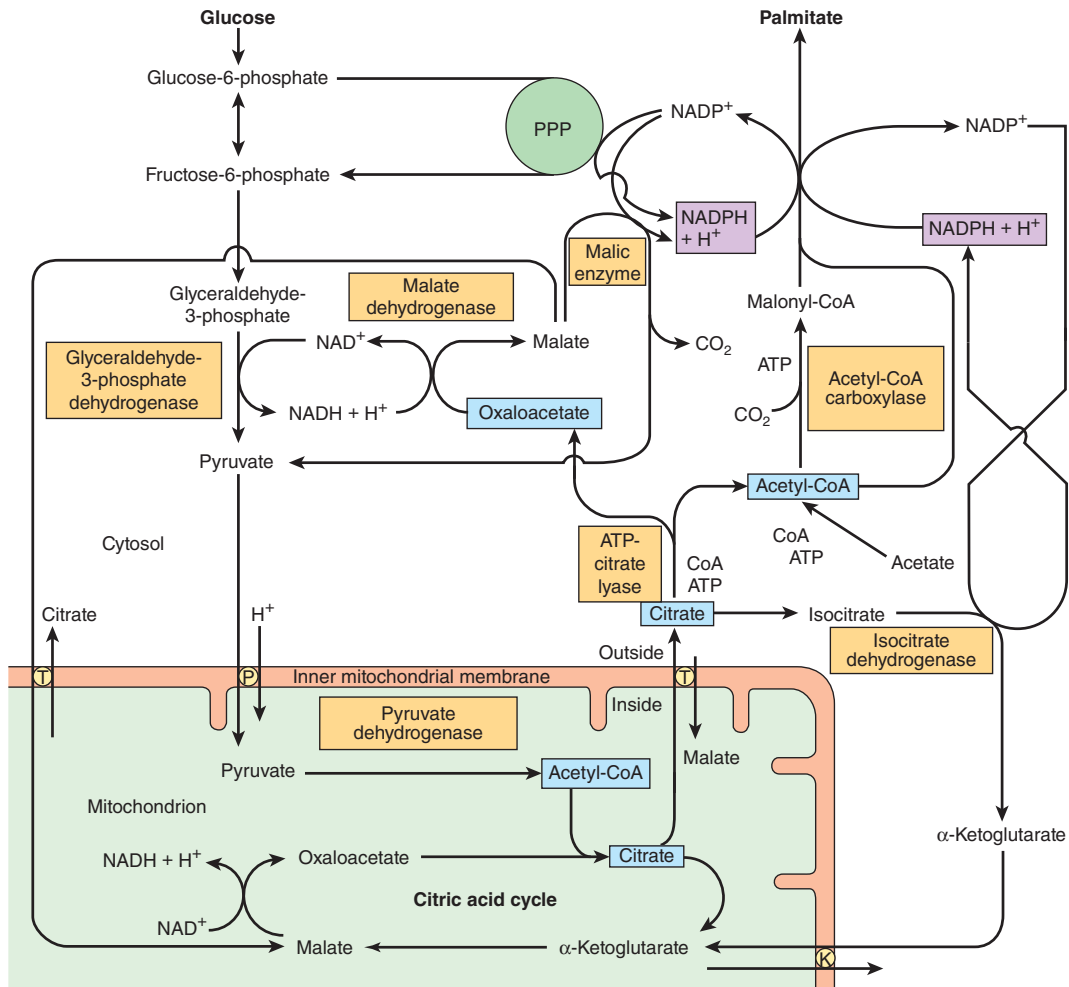

FIGURE 23-4 The provision of acetyl-CoA and NADPH for lipogenesis. (K, α -ketoglutarate transporter; P, pyruvate transporter; PPP, pentose phosphate pathway; T, tricarboxylate transporter.)

Elongation of Fatty Acid Chains Occurs in the Endoplasmic Reticulum

This pathway (the “microsomal system”) elongates saturated and unsaturated fatty acyl-CoAs (from C_{10} upward) by two carbons, using malonyl-CoA as the acetyl donor and NADPH as the reductant, and is catalyzed by the microsomal **fatty acid elongase** system of enzymes (Figure 23-5). Elongation of stearyl-CoA in brain increases rapidly during myelination in order to provide C_{22} and C_{24} fatty acids for sphingolipids.

THE NUTRITIONAL STATE REGULATES LIPOGENESIS

Excess carbohydrate is stored as fat in many animals in anticipation of periods of caloric deficiency such as starvation, hibernation, etc, and to provide energy for use between meals in animals, including humans, that take their food at spaced intervals. Lipogenesis converts surplus glucose and intermediates such as pyruvate, lactate, and acetyl-CoA to fat, assisting the anabolic phase of this feeding cycle. The nutritional state

of the organism is the main factor regulating the rate of lipogenesis. Thus, the rate is high in the well-fed animal whose diet contains a high proportion of carbohydrate. It is depressed by restricted caloric intake, high-fat diet, or a deficiency of insulin, as in diabetes mellitus. These latter conditions are associated with increased concentrations of plasma-free fatty acids, and an inverse relationship has been demonstrated between hepatic lipogenesis and the concentration of serum-free fatty acids. Lipogenesis is increased when sucrose is fed instead of glucose because fructose bypasses the phosphofruktokinase control point in glycolysis and floods the lipogenic pathway (see Figure 20-5).

SHORT- & LONG-TERM MECHANISMS REGULATE LIPOGENESIS

Long-chain fatty acid synthesis is controlled in the short term by allosteric and covalent modification of enzymes and in the long term by changes in gene expression governing rates of synthesis of enzymes.

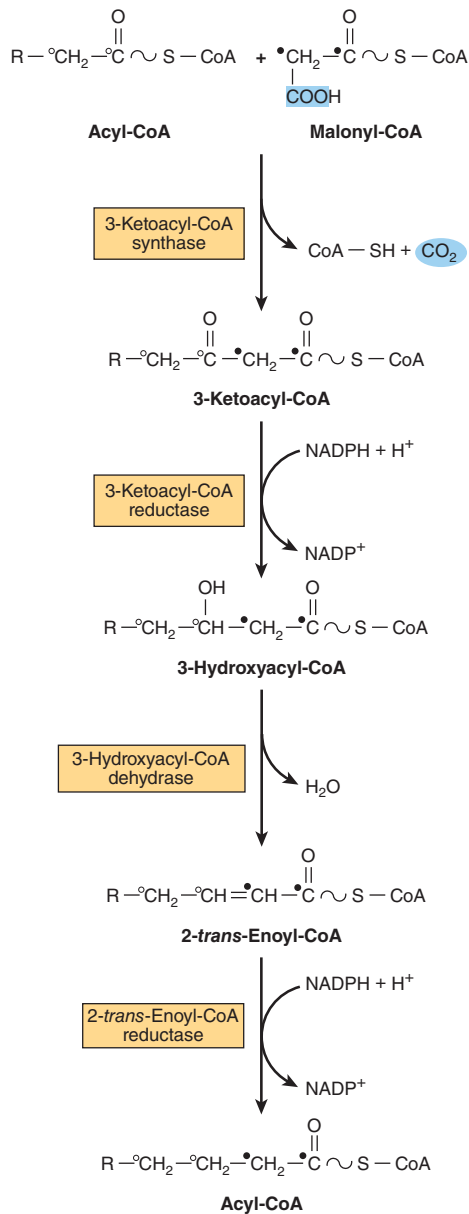

FIGURE 23-5 Microsomal elongase system for fatty acid chain elongation. NADH is also used by the reductases, but NADPH is preferred.

Acetyl-CoA Carboxylase Is the Most Important Enzyme in the Regulation of Lipogenesis

Acetyl-CoA carboxylase is an allosteric enzyme and is activated by **citrate**, which increases in concentration in the well-fed state and is an indicator of a plentiful supply of acetyl-CoA. Citrate promotes the conversion of the enzyme from an inactive dimer (two subunits of the enzyme complex) to an active polymeric form, with a molecular mass of several million. Inactivation is promoted by phosphorylation of the enzyme and by long-chain acyl-CoA molecules, an example of negative feedback inhibition by a product of a reaction (**Figure 23-6**). Thus, if acyl-CoA accumulates because it is not esterified quickly enough or because of increased lipolysis or

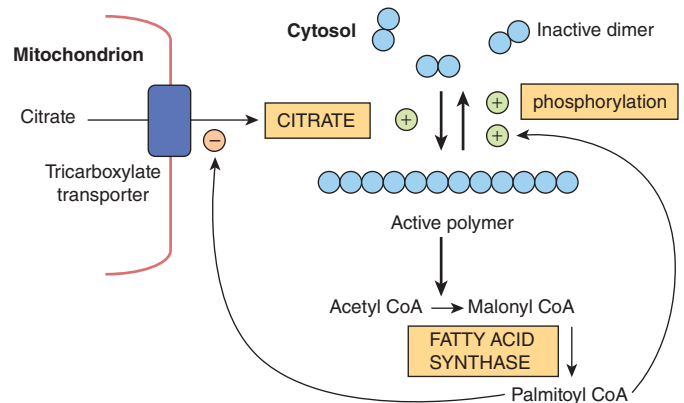

FIGURE 23-6 Regulation of acetyl CoA carboxylase. Acetyl-CoA carboxylase is activated by citrate, which promotes the conversion of the enzyme from an inactive dimer to an active polymeric form. Inactivation is promoted by phosphorylation of the enzyme and by long-chain acyl-CoA molecules such as palmitoyl CoA. In addition, acyl-CoA inhibits the tricarboxylate transporter, which transports citrate out of mitochondria into the cytosol, thus decreasing the citrate concentration in the cytosol and favoring inactivation of the enzyme.

an influx of free fatty acids into the tissue, it will automatically reduce the synthesis of new fatty acid. Acyl-CoA also inhibits the mitochondrial **tricarboxylate transporter**, thus preventing activation of the enzyme by egress of citrate from the mitochondria into the cytosol (**Figure 23-6**).

Acetyl-CoA carboxylase is also regulated by hormones such as **glucagon**, **epinephrine**, and **insulin** via changes in its phosphorylation state (details in **Figure 23-7**).

Pyruvate Dehydrogenase Is Also Regulated by Acyl-CoA

Acyl-CoA causes an inhibition of pyruvate dehydrogenase by inhibiting the ATP-ADP exchange transporter of the inner mitochondrial membrane, which leads to increased intramitochondrial (ATP)/(ADP) ratios and therefore to conversion of active to inactive pyruvate dehydrogenase (see **Figure 17-6**), thus regulating the availability of acetyl-CoA for lipogenesis. Furthermore, oxidation of acyl-CoA due to increased levels of free fatty acids may increase the ratios of (acetyl-CoA)/(CoA) and (NADH)/(NAD⁺) in mitochondria, inhibiting pyruvate dehydrogenase.

Insulin Also Regulates Lipogenesis by Other Mechanisms

Insulin stimulates lipogenesis by several other mechanisms as well as by increasing acetyl-CoA carboxylase activity. It increases the transport of glucose into the cell (eg, in adipose tissue), increasing the availability of both pyruvate for fatty acid synthesis and glycerol-3-phosphate for triacylglycerol synthesis via esterification of the newly formed fatty acids (see **Figure 24-2**), and also converts the inactive form of pyruvate dehydrogenase to the active form in adipose tissue, but not in liver. Insulin also—by its ability to depress the level of intracellular cAMP—**inhibits lipolysis** in adipose tissue and reducing the concentration of plasma-free fatty acids and, therefore, long-chain acyl-CoA, which are inhibitors of lipogenesis.

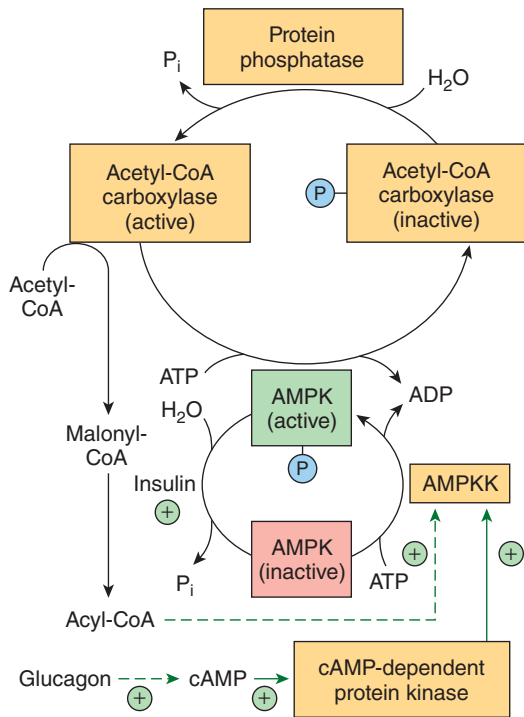

FIGURE 23-7 Regulation of acetyl-CoA carboxylase by phosphorylation/dephosphorylation. The enzyme is inactivated by phosphorylation by AMP-activated protein kinase (AMPK), which in turn is phosphorylated and activated by AMP-activated protein kinase kinase (AMPKK). Glucagon (and epinephrine) increase cAMP, and thus activate this latter enzyme via cAMP-dependent protein kinase. The kinase kinase enzyme is also believed to be activated by acyl-CoA. Insulin activates acetyl-CoA carboxylase via dephosphorylation of AMPK.

The Fatty Acid Synthase Complex & Acetyl-CoA Carboxylase Are Adaptive Enzymes

These enzymes adapt to the body's physiologic needs via changes in gene expression which lead to increases in total amount present in the fed state and decreases during intake of a high-fat diet and in conditions such as starvation, and diabetes mellitus. **Insulin** plays an important role, causing gene expression and induction of enzyme biosynthesis, and **glucagon** (via cAMP) antagonizes this effect. Feeding fats containing polyunsaturated fatty acids coordinately regulates the inhibition of expression of key enzymes of glycolysis and lipogenesis. These mechanisms for longer term regulation of lipogenesis take several days to become fully manifested and augment the direct and immediate effect of free fatty acids and hormones such as insulin and glucagon.

SOME POLYUNSATURATED FATTY ACIDS CANNOT BE SYNTHESIZED BY MAMMALS & ARE NUTRITIONALLY ESSENTIAL

Certain long-chain unsaturated fatty acids of metabolic significance in mammals are shown in **Figure 23-8**. Other C_{20} , C_{22} , and C_{24} polyenoic fatty acids may be derived from oleic,

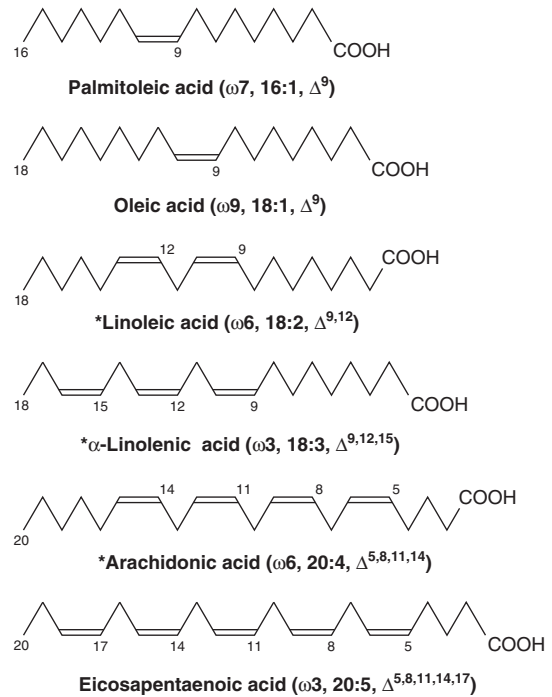

FIGURE 23-8 Structure of some unsaturated fatty acids.

Although the carbon atoms in the molecules are conventionally numbered—ie, numbered from the carboxyl terminal—the ω numbers (eg, $\omega 7$ in palmitoleic acid) are calculated from the reverse end (the methyl terminal) of the molecules. The information in parentheses shows, for instance, that α -linolenic acid contains double bonds starting at the third carbon from the methyl terminal, has 18 carbons and 3 double bonds, and has these double bonds at the 9th, 12th, and 15th carbons from the carboxyl terminal. (*Classified as “essential fatty acids.”)

linoleic, and α -linolenic acids by chain elongation. Palmitoleic and oleic acids are not essential in the diet because the tissues can introduce a double bond at the Δ^9 position of a saturated fatty acid. **Linoleic and α -linolenic acids** are the only fatty acids known to be essential for the complete nutrition of many species of animals, including humans, and are termed the **nutritionally essential fatty acids**. In most mammals, **arachidonic acid** can be formed from linoleic acid. Double bonds can be introduced at the Δ^4 , Δ^5 , Δ^6 , and Δ^9 positions (see Chapter 21) in most animals, but never beyond the Δ^9 position. In contrast, plants are able to synthesize the nutritionally essential fatty acids by introducing double bonds at the Δ^{12} and Δ^{15} positions.

MONOUNSATURATED FATTY ACIDS ARE SYNTHESIZED BY A Δ^9 DESATURASE SYSTEM

Several tissues including the liver are considered to be responsible for the formation of nonessential monounsaturated fatty acids from saturated fatty acids. The first double bond introduced into a saturated fatty acid is nearly always in the Δ^9

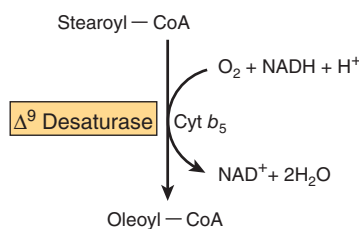

FIGURE 23-9 Microsomal Δ^9 desaturase.

position. An enzyme system— Δ^9 desaturase (Figure 23-9)—in the endoplasmic reticulum catalyzes the conversion of palmitoyl-CoA or stearoyl-CoA to palmitoleoyl-CoA or oleoyl-CoA, respectively. Oxygen and either NADH or NADPH are necessary for the reaction. The enzymes appear to be similar to a monooxygenase system involving cytochrome b_5 (see Chapter 12).

SYNTHESIS OF POLYUNSATURATED FATTY ACIDS INVOLVES DESATURASE & ELONGASE ENZYME SYSTEMS

Additional double bonds introduced into existing monounsaturated fatty acids are always separated from each other by a methylene group (methylene interrupted) except in bacteria. Since animals have a Δ^9 desaturase, they are able to synthesize the $\omega 9$ (oleic acid) family of unsaturated fatty acids completely by a combination of chain elongation and desaturation (Figures 23-9 and 23-10) after the formation of saturated fatty acids by the pathways described in this chapter. However, as indicated above, linoleic ($\omega 6$) or α -linolenic ($\omega 3$) acids are required for the synthesis of the other members of the $\omega 6$ or $\omega 3$ families (pathways shown in Figure 23-10) and must be supplied in the diet. Linoleic acid is converted to arachidonic acid (20:4 $\omega 6$) via γ -linolenic acid (18:3 $\omega 6$). The nutritional requirement for arachidonate may thus be dispensed with if there is adequate linoleate in the diet. Cats, however, cannot carry out this conversion owing to the absence of Δ^6 desaturase and must obtain arachidonate in their diet. The desaturation and chain elongation system is greatly diminished in the starving state, in response to glucagon and epinephrine administration, and in the absence of insulin as in type 1 diabetes mellitus.

DEFICIENCY SYMPTOMS OCCUR WHEN THE ESSENTIAL FATTY ACIDS (EFA) ARE ABSENT FROM THE DIET

Rats fed a purified nonlipid diet containing vitamins A and D exhibit a reduced growth rate and reproductive deficiency which may be cured by the addition of **linoleic**, **α -linolenic**, and **arachidonic acids** to the diet. These fatty acids are found

in high concentrations in vegetable oils (see Table 21-2) and in small amounts in animal carcasses. Essential fatty acids are required for prostaglandin, thromboxane, leukotriene, and lipoxin formation (see below), and they also have various other functions that are less well defined. They are found in the structural lipids of the cell, often in the position 2 of phospholipids, and are concerned with the structural integrity of the mitochondrial membrane.

Arachidonic acid is present in membranes and accounts for 5% to 15% of the fatty acids in phospholipids. Docosahexaenoic acid (DHA; $\omega 3$, 22:6), which is synthesized to a limited extent from α -linolenic acid or obtained directly from fish oils, is present in high concentrations in retina, cerebral cortex, testis, and sperm. DHA is particularly needed for development of the brain and retina and is supplied via the placenta and milk. Patients with **retinitis pigmentosa** are reported to have low blood levels of DHA. In **essential fatty acid deficiency**, nonessential polyenoic acids of the $\omega 9$ family, particularly $\Delta^{5,8,11}$ -eicosatrienoic acid ($\omega 9$ 20:3) (Figure 23-10), replace the essential fatty acids in phospholipids, other complex lipids, and membranes. The triene:tetraene ratio in plasma lipids can be used to diagnose the extent of essential fatty acid deficiency.

ICOSANOIDS ARE FORMED FROM C_{20} POLYUNSATURATED FATTY ACIDS

Arachidonate and some other C_{20} polyunsaturated fatty acids give rise to **eicosanoids**, physiologically and pharmacologically active compounds known as **prostaglandins (PG)**, **thromboxanes (TX)**, **leukotrienes (LT)**, and **lipoxins (LX)** (see Chapter 21). Physiologically, they are considered to act as local hormones functioning through G-protein-linked receptors to elicit their biochemical effects.

There are three groups of eicosanoids that are synthesized from C_{20} eicosanoic acids derived from the essential fatty acids **linoleate** and **α -linolenate**, or directly from dietary arachidonate and eicosapentaenoate (Figure 23-11). Arachidonate, which may be obtained from the diet, but is usually derived from the position 2 of phospholipids in the plasma membrane by the action of phospholipase A_2 (Figure 24-6), is the substrate for the synthesis of the PG_2 , TX_2 series (**prostanoids**) by the **cyclooxygenase pathway**, or the LT_4 and LX_4 series by the **lipoxygenase pathway**, with the two pathways competing for the arachidonate substrate (Figure 23-11).

THE CYCLOOXYGENASE PATHWAY IS RESPONSIBLE FOR PROSTANOID SYNTHESIS

Prostanoid synthesis (Figure 23-12) involves the consumption of two molecules of O_2 catalyzed by **cyclooxygenase (COX)** (also called **prostaglandin H synthase**), an enzyme that has two activities, a **cyclooxygenase** and **peroxidase**.

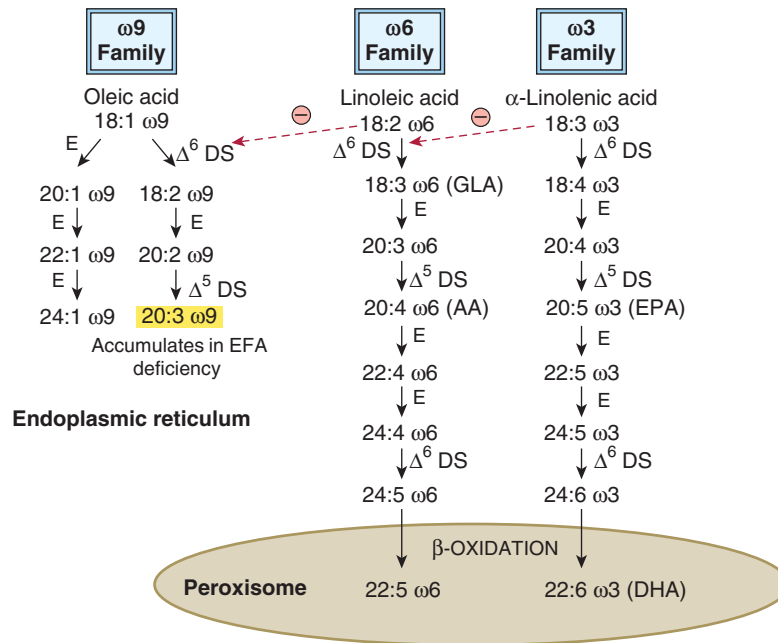

FIGURE 23-10 Biosynthesis of the ω 9, ω 6, and ω 3 families of polyunsaturated fatty acids. In animals, the ω 9, ω 6, and ω 3 families of polyunsaturated fatty acids are synthesized in the endoplasmic reticulum from oleic, linoleic and β -linolenic acids, respectively, by a series of elongation and desaturation reactions. The production of 22:5 ω 6 (osbond acid) or 22:6 ω 3 (docosahexanoic acid (DHA)), however, requires one cycle of β -oxidation which takes place inside peroxisomes after the formation of 24:5 ω 6 or 24:6 ω 3. AA, arachidonic acid; E, elongase; EFA, essential fatty acids; EPA, eicosapentaenoic acid; GLA, γ -linolenic acid; DS, desaturase. \ominus , Inhibition.

COX is present as two isoenzymes, **COX-1** and **COX-2**. The product, an endoperoxide (PGH), is converted to prostaglandins D and E as well as to a thromboxane (TXA₂) and prostacyclin (PGI₂). Each cell type produces only one type of prostanoid. The NSAID **aspirin** inhibits COX-1 and COX-2. Other NSAIDs include **indomethacin** and **ibuprofen**, and usually inhibit cyclooxygenases by competing with arachidonate. Since inhibition of COX-1 causes the stomach irritation often associated with taking NSAIDs, attempts have been made to develop drugs which selectively inhibit COX-2 (**coxibs**). Unfortunately, however, the success of this approach has been limited and some coxibs have been withdrawn or suspended from the market due to undesirable side effects and safety issues. Transcription of COX-2—but not of COX-1—is completely inhibited by **anti-inflammatory corticosteroids**.

Essential Fatty Acids Do Not Exert All Their Physiologic Effects via Prostaglandin Synthesis

The role of essential fatty acids in membrane formation is unrelated to prostaglandin formation. Prostaglandins do not relieve symptoms of essential fatty acid deficiency, and an essential fatty acid deficiency is not caused by inhibition of prostaglandin synthesis.

Cyclooxygenase Is a “Suicide Enzyme”

“Switching off” of prostaglandin activity is partly achieved by a remarkable property of cyclooxygenase—that of self-catalyzed destruction; that is, it is a “**suicide enzyme**.” Furthermore, the inactivation of prostaglandins by **15-hydroxyprostaglandin dehydrogenase** is rapid. Blocking the action of this enzyme with sulfasalazine or indomethacin can prolong the half-life of prostaglandins in the body.

LEUKOTRIENES & LIPOXINS ARE FORMED BY THE LIPOXYGENASE PATHWAY

The **leukotrienes** are a family of conjugated trienes formed from eicosanoic acids in leukocytes, mastocytoma cells, platelets, and macrophages by the **lipoxygenase pathway** in response to both immunologic and nonimmunologic stimuli. Three different lipoxygenases (dioxygenases) insert oxygen into the 5, 12, and 15 positions of arachidonic acid, giving rise to hydroperoxides (HPETE). Only **5-lipoxygenase** forms leukotrienes (details in **Figure 23-13**). **Lipoxins** are a family of conjugated tetraenes also arising in leukocytes. They are formed by the combined action of more than one lipoxygenase (**Figure 23-13**).

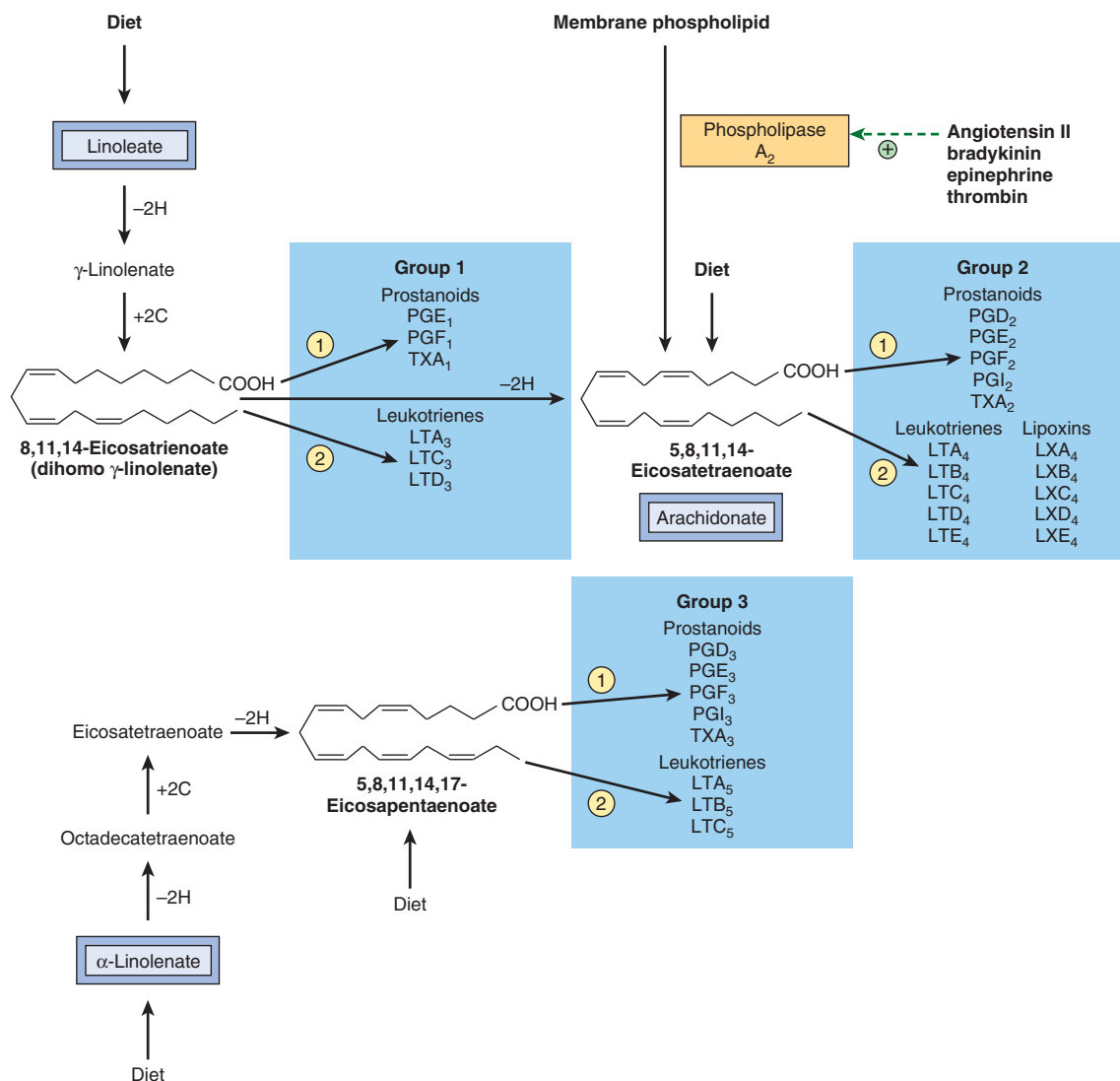

FIGURE 23-11 The three groups of eicosanoids and their biosynthetic origins. (①, cyclooxygenase pathway; ②, lipoxygenase pathway; LT, leukotriene; LX, lipoxin; PG, prostaglandin; PGI, prostacyclin; TX, thromboxane.) The subscript denotes the total number of double bonds in the molecule and the series to which the compound belongs.

CLINICAL ASPECTS

Symptoms of Essential Fatty Acid Deficiency in Humans Include Skin Lesions & Impairment of Lipid Transport

In adults subsisting on ordinary diets, no signs of essential fatty acid deficiencies have been reported. However, infants receiving formula diets low in fat and patients maintained for long periods exclusively by intravenous nutrition low in essential fatty acids show deficiency symptoms that can be prevented by an essential fatty acid intake of 1% to 2% of the total caloric requirement.

Abnormal Metabolism of Essential Fatty Acids Occurs in Several Diseases

Abnormal metabolism of essential fatty acids, which may be connected with dietary insufficiency, has been noted in cystic

fibrosis, acrodermatitis enteropathica, hepatorenal syndrome, Sjögren-Larsson syndrome, multisystem neuronal degeneration, Crohn disease, cirrhosis and alcoholism, and Reye syndrome. Elevated levels of very long chain polyenoic acids have been found in the brains of patients with Zellweger syndrome (see Chapter 22). Diets with a high P:S (polyunsaturated:saturated fatty acid) ratio reduce serum cholesterol levels and are considered to be beneficial in terms of the risk of development of coronary heart disease.

Trans Fatty Acids Are Implicated in Various Disorders

Small amounts of trans-unsaturated fatty acids are found in ruminant fat (eg, butter fat has 2%-7%), where they arise from the action of microorganisms in the rumen, but the main source in the human diet is from partially hydrogenated vegetable oils (eg, margarine) (see Chapter 21). Trans fatty

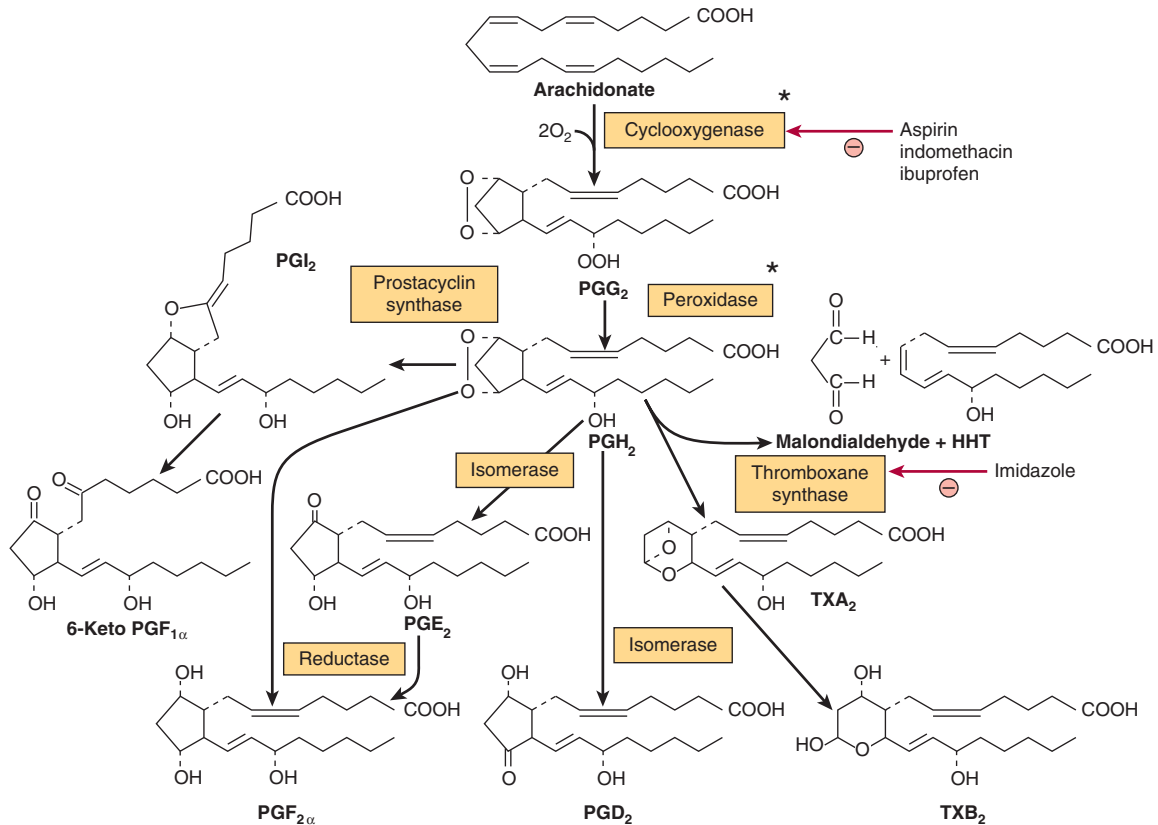

FIGURE 23-12 Conversion of arachidonic acid to prostaglandins and thromboxanes of series 2. (HHT, hydroxyheptadecatrienoate; PG, prostaglandin; PGI, prostacyclin; TX, thromboxane.) (*Both of these starred activities are attributed to the cyclooxygenase enzyme [prostaglandin H synthase]. Similar conversions occur in prostaglandins and thromboxanes of series 1 and 3.)

acids compete with essential fatty acids and may exacerbate essential fatty acid deficiency. Moreover, they are structurally similar to saturated fatty acids (see Chapter 21) and have comparable effects in the promotion of hypercholesterolemia and atherosclerosis (see Chapter 26).

Prostanoids Are Potent, Biologically Active Substances

Thromboxanes are synthesized in platelets and upon release cause vasoconstriction and platelet aggregation. Their synthesis is specifically inhibited by low-dose aspirin. **Prostacyclins (PGI₂)** are produced by blood vessel walls and are potent inhibitors of platelet aggregation. Thus, thromboxanes and prostacyclins are antagonistic. PG₃ and TX₃, formed from eicosapentaenoic acid (EPA), inhibit the release of arachidonate from phospholipids and the formation of PG₂ and TX₂. PGI₃ is as potent an antiaggregator of platelets as PGI₂, but TXA₃ is a weaker aggregator than TXA₂, changing the balance of activity and favoring longer clotting times. As little as 1 ng/mL of plasma prostaglandins causes contraction of smooth muscle in animals. Potential therapeutic uses include prevention of conception, induction of labor at term, termination of

pregnancy, prevention or alleviation of gastric ulcers, control of inflammation and of blood pressure, and relief of asthma and nasal congestion. In addition, PGD₂ is a potent sleep-promoting substance. Prostaglandins increase cAMP in platelets, thyroid, corpus luteum, fetal bone, adenohypophysis, and lung but reduce cAMP in renal tubule cells and adipose tissue (see Chapter 25).

Leukotrienes & Lipoxins Are Potent Regulators of Many Disease Processes

Slow-reacting substance of anaphylaxis (SRS-A) is a mixture of leukotrienes C₄, D₄, and E₄. This mixture of leukotrienes is a potent constrictor of the bronchial airway musculature. These leukotrienes together with **leukotriene B₄** also cause vascular permeability and attraction and activation of leukocytes and are important regulators in many diseases involving inflammatory or immediate hypersensitivity reactions, such as asthma. Leukotrienes are vasoactive, and 5-lipoxygenase has been found in arterial walls. Evidence supports an anti-inflammatory role for lipoxins in vasoactive and immunoregulatory function, eg, as counter-regulatory compounds (**chalcones**) of the immune response.

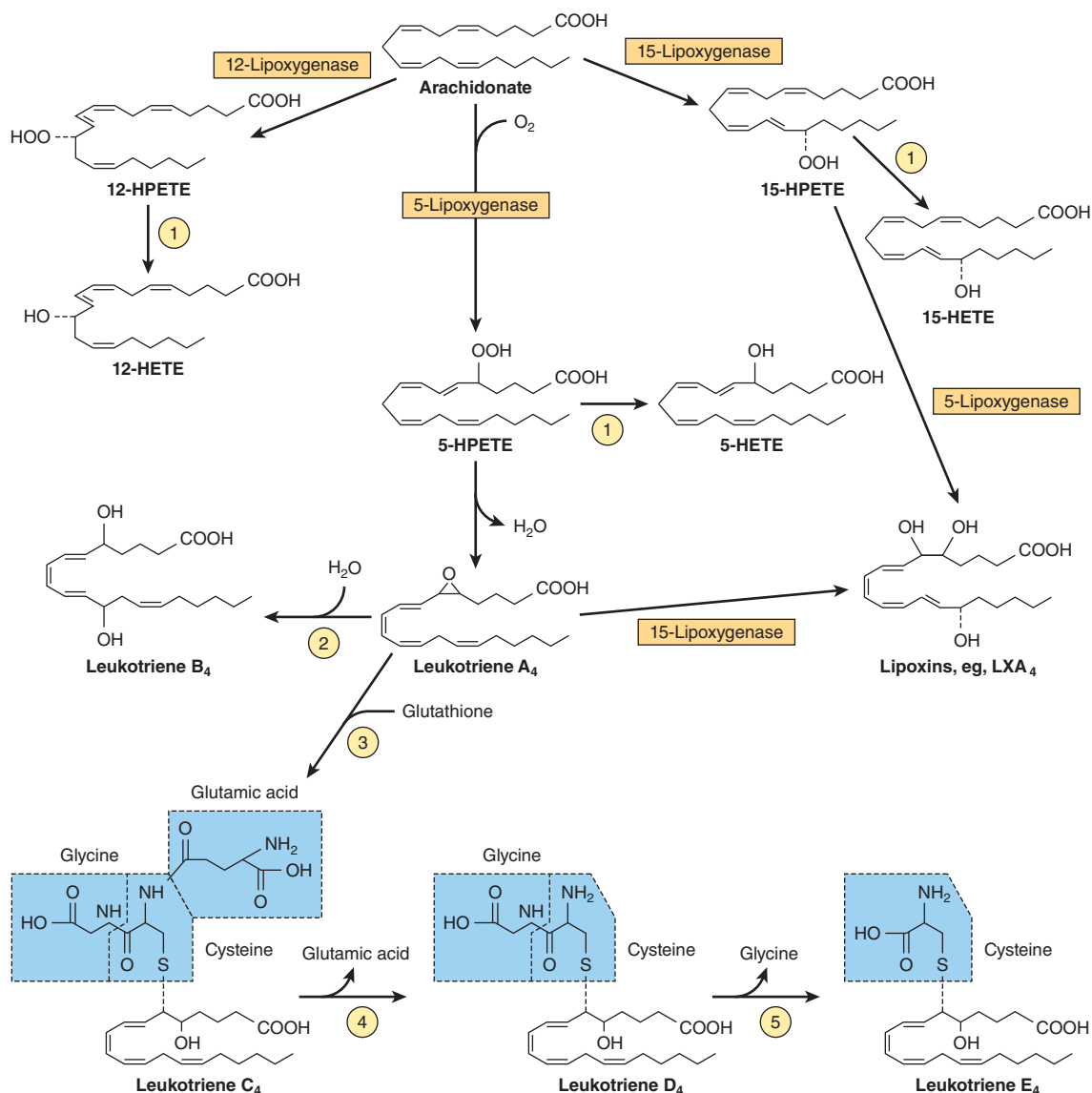

FIGURE 23-13 Conversion of arachidonic acid to leukotrienes and lipoxins of series 4 via the lipoxigenase pathway. Some similar conversions occur in series 3 and 5 leukotrienes. (①, peroxidase; ②, leukotriene A_4 epoxide hydrolase; ③, glutathione S-transferase; ④, γ -glutamyltranspeptidase; ⑤, cysteinyl-glycine dipeptidase; HETE, hydroxyeicosatetraenoate; HPETE, hydroperoxyeicosatetraenoate.)

SUMMARY

- The synthesis of long-chain fatty acids (lipogenesis) is carried out by two enzyme systems: acetyl-CoA carboxylase and fatty acid synthase.
- The pathway converts acetyl-CoA to palmitate and requires NADPH, ATP, Mn^{2+} , biotin, and pantothenic acid as cofactors.
- Acetyl-CoA carboxylase converts acetyl-CoA to malonyl-CoA, and then fatty acid synthase, a multienzyme complex consisting of two identical polypeptide chains, each containing six separate enzymatic activities and ACP, catalyzes the formation of palmitate from one acetyl-CoA and seven malonyl-CoA molecules.
- Lipogenesis is regulated at the acetyl-CoA carboxylase step by allosteric modifiers, phosphorylation/dephosphorylation, and induction and repression of enzyme synthesis. The enzyme is allosterically activated by citrate and deactivated by long-chain acyl-CoA. Dephosphorylation (eg, by insulin) promotes its activity, while phosphorylation (eg, by glucagon or epinephrine) is inhibitory.
- Biosynthesis of unsaturated long-chain fatty acids is achieved by desaturase and elongase enzymes, which introduce double bonds and lengthen existing acyl chains, respectively.
- Higher animals have Δ^4 , Δ^5 , Δ^6 , and Δ^9 desaturases but cannot insert new double bonds beyond the position 9 of fatty acids. Thus, the essential fatty acids linoleic ($\omega 6$) and α -linolenic ($\omega 3$) must be obtained from the diet.
- Eicosanoids are derived from C_{20} (eicosanoic) fatty acids synthesized from the essential fatty acids and make up important groups of physiologically and pharmacologically active compounds, including the prostaglandins, thromboxanes, leukotrienes, and lipoxins.

REFERENCES

- Fitzpatrick FA: Cyclooxygenase enzymes: regulation and function. *Curr Pharm Des* 2004;10:577.
- Lands B: Consequences of essential fatty acids. *Nutrients* 2012;4:1338.
- McMahon B, Mitchell S, Brady HR, et al: Lipoxins: revelations on resolution. *Trends Pharmacol Sci* 2001;22:391.
- Miyazaki M, Ntambi JM: Fatty acid desaturation and chain elongation in mammals. In: *Biochemistry of Lipids, Lipoproteins and Membranes*, 5th ed. Vance DE, Vance JE (editors). Elsevier, 2008;191–212.
- Smith WL, Murphy RC: The eicosanoids: cyclooxygenase, lipoxygenase, and epoxygenase pathways. In: *Biochemistry of Lipids, Lipoproteins and Membranes*, 5th ed. Vance DE, Vance JE (editors). Elsevier, 2008;331–362.
- Smith S, Witkowski A, Joshi AK: Structural and functional organisation of the animal fatty acid synthase. *Prog Lipid Res* 2003;42:289.
- Sul HS, Smith S: Fatty acid synthesis in eukaryotes. In: *Biochemistry of Lipids, Lipoproteins and Membranes*, 5th ed. Vance DE, Vance JE (editors). Elsevier, 2008;155–190.
- Tong L: Acetyl-coenzyme A carboxylase: crucial metabolic enzyme and an attractive target for drug discovery. *Cell Mol Life Sci* 2005;62:1784.
- Wijendran V, Hayes KC: Dietary n-6 and n-3 fatty acid balance and cardiovascular health. *Annu Rev Nutr* 2004;24:597.

Metabolism of Acylglycerols & Sphingolipids

Kathleen M. Botham, PhD, DSc & Peter A. Mayes, PhD, DSc

OBJECTIVES

After studying this chapter, you should be able to:

- Appreciate that the catabolism of triacylglycerols involves hydrolysis by a lipase to free fatty acids and glycerol and indicate the fate of these metabolites.
- Understand that glycerol-3-phosphate is the substrate for the formation of both triacylglycerols and phosphoglycerols and that a branch point at phosphatidate leads to the synthesis of inositol phospholipids and cardiolipin via one branch and triacylglycerols and other phospholipids via the second branch.
- Explain that plasmalogens and platelet activating factor (PAF) are formed by a complex pathway starting from dihydroxyacetone phosphate.
- Illustrate the role of various phospholipases in the degradation and remodeling of phospholipids.
- Appreciate that ceramide is produced from the amino acid serine and is the precursor from which all sphingolipids are formed.
- Indicate how sphingomyelin and glycosphingolipids are produced by reacting ceramide with phosphatidylcholine (with the release of diacylglycerol) or sugar residue(s), respectively.
- Identify examples of disease processes caused by defects in phospholipid or sphingolipid synthesis or breakdown.

BIOMEDICAL IMPORTANCE

Acylglycerols constitute the majority of lipids in the body. Triacylglycerols are the major lipids in fat deposits and in food, and their roles in lipid transport and storage and in various diseases such as obesity, diabetes, and hyperlipoproteinemia will be described in subsequent chapters. The amphipathic nature of phospholipids and sphingolipids makes them ideally suitable as the main lipid component of cell membranes.

Phospholipids also take part in the metabolism of many other lipids. Some phospholipids have specialized functions; eg, dipalmitoyl lecithin is a major component of **lung surfactant**, which is lacking in **respiratory distress syndrome** of

the newborn. Inositol phospholipids in the cell membrane act as precursors of **hormone second messengers**, and **platelet-activating factor** is an alkylphospholipid. Glycosphingolipids, containing sphingosine and sugar residues as well as fatty acid that are found in the outer leaflet of the plasma membrane with their oligosaccharide chains facing outward, form part of the **glycocalyx** of the cell surface and are important (1) in cell adhesion and cell recognition, (2) as receptors for bacterial toxins (eg, the toxin that causes cholera), and (3) as ABO blood group substances. A dozen or so **glycolipid storage diseases** have been described (eg, Gaucher's disease and Tay-Sachs disease), each due to a genetic defect in the pathway for glycolipid degradation in the lysosomes.

HYDROLYSIS INITIATES CATABOLISM OF TRIACYLGLYCEROLS

Triacylglycerols must be hydrolyzed by a **lipase** to their constituent fatty acids and glycerol before further catabolism can proceed. Much of this hydrolysis (lipolysis) occurs in adipose tissue with release of free fatty acids into the plasma, where they are found combined with serum albumin (see Figure 25–7). This is followed by free fatty acid uptake into tissues (including liver, heart, kidney, muscle, lung, testis, and adipose tissue, but not readily by brain), where they are oxidized to obtain energy or reesterified. The utilization of glycerol depends upon whether such tissues have the enzyme **glycerol kinase**, which is found in significant amounts in liver, kidney, intestine, brown adipose tissue, and the lactating mammary gland.

TRIACYLGLYCEROLS & PHOSPHOGLYCEROLS ARE FORMED BY ACYLATION OF TRIOSE PHOSPHATES

The major pathways of triacylglycerol and phosphoglycerol biosynthesis are outlined in **Figure 24–1**. Important substances such as triacylglycerols, phosphatidylcholine, phosphatidylethanolamine, phosphatidylinositol, and cardiolipin, a constituent of mitochondrial membranes, are formed from **glycerol-3-phosphate**. Significant branch points in the pathway occur at the **phosphatidate** and **diacylglycerol** steps. Phosphoglycerols containing an ether link ($—C—O—C—$), the best known of which are plasmalogens and platelet-activating factor (PAF), are derived from **dihydroxyacetone phosphate**. Glycerol 3-phosphate and dihydroxyacetone phosphate are intermediates in glycolysis, making a very important connection between carbohydrate and lipid metabolism (see Chapter 14).

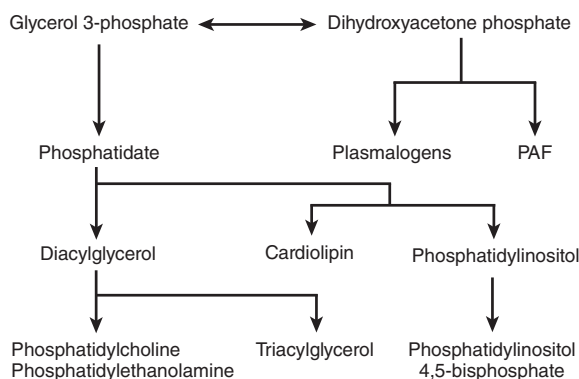

FIGURE 24–1 Overview of acylglycerol biosynthesis. (PAF, platelet-activating factor.)

Phosphatidate Is the Common Precursor in the Biosynthesis of Triacylglycerols, Many Phosphoglycerols, & Cardiolipin

Both glycerol and fatty acids must be activated by ATP before they can be incorporated into acylglycerols. **Glycerol kinase** catalyzes the activation of glycerol to *sn*-glycerol 3-phosphate. If the activity of this enzyme is absent or low, as in muscle or adipose tissue, most of the glycerol-3-phosphate is formed from dihydroxyacetone phosphate by **glycerol-3-phosphate dehydrogenase** (Figure 24–2).

Biosynthesis of Triacylglycerols

Two molecules of acyl-CoA, formed by the activation of fatty acids by **acyl-CoA synthetase** (see Chapter 22), combine with glycerol-3-phosphate to form **phosphatidate** (1,2-diacylglycerol phosphate). This takes place in two stages, catalyzed by **glycerol-3-phosphate acyltransferase** and **1-acylglycerol-3-phosphate acyltransferase**. Phosphatidate is converted by **phosphatidate phosphohydrolase** (also called **phosphatidate phosphatase** (PAP)) and **diacylglycerol acyltransferase** (DGAT) to 1,2-diacylglycerol and then triacylglycerol. **Lipins**, a family of three proteins, have PAP activity and they also act as transcription factors which regulate the expression of genes involved in lipid metabolism. DGAT catalyzes the only step specific for triacylglycerol synthesis and is thought to be rate limiting in most circumstances. In intestinal mucosa, **monoacylglycerol acyltransferase** converts **monoacylglycerol** to 1,2-diacylglycerol in the **monoacylglycerol pathway**. Most of the activity of these enzymes resides in the endoplasmic reticulum, but some is found in mitochondria. Although phosphatidate phosphohydrolase protein is found mainly in the cytosol, the active form of the enzyme is membrane bound.

Biosynthesis of Phospholipids

In the biosynthesis of **phosphatidylcholine** and **phosphatidylethanolamine** (Figure 24–2), choline or ethanolamine must first be activated by phosphorylation by ATP followed by linkage to CDP. The resulting CDP-choline or CDP-ethanolamine reacts with 1,2-diacylglycerol to form either phosphatidylcholine or phosphatidylethanolamine, respectively. **Phosphatidylserine** is formed from phosphatidylethanolamine directly by reaction with serine (Figure 24–2). Phosphatidylserine may re-form phosphatidylethanolamine by decarboxylation. An alternative pathway in liver enables phosphatidylethanolamine to give rise directly to phosphatidylcholine by progressive methylation of the ethanolamine residue. In spite of these sources of choline, it is considered to be an essential nutrient in many mammalian species, although this has not been established in humans.

The regulation of triacylglycerol, phosphatidylcholine, and phosphatidylethanolamine biosynthesis is driven by the availability of free fatty acids. Those that escape oxidation are preferentially converted to phospholipids, and when this requirement is satisfied, they are used for triacylglycerol synthesis.

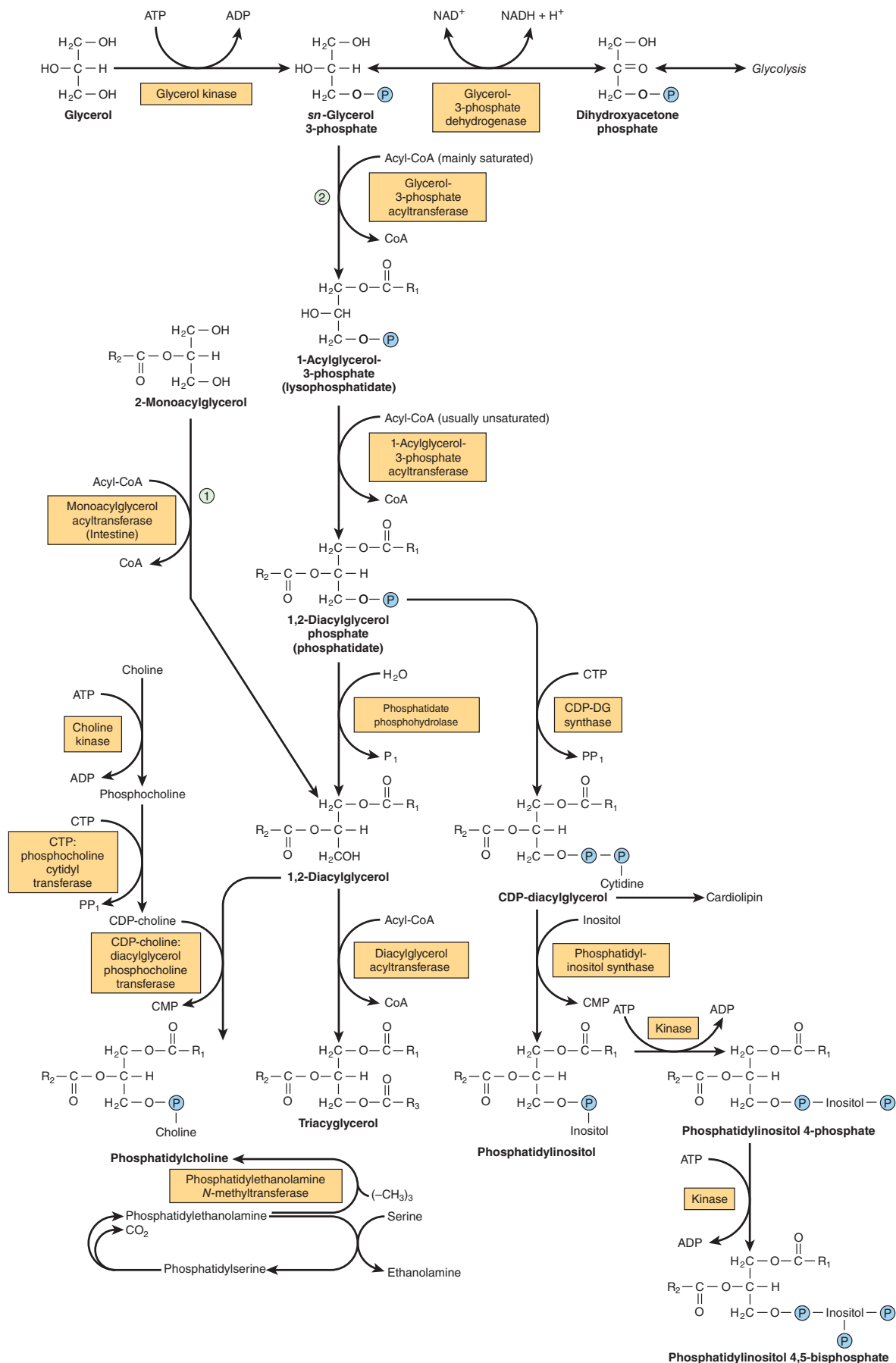

FIGURE 24-2 Biosynthesis of triacylglycerol and phospholipids. ①, Monoacylglycerol pathway; ②, glycerol phosphate pathway. Phosphatidylethanolamine may be formed from ethanolamine by a pathway similar to that shown for the formation of phosphatidylcholine from choline.

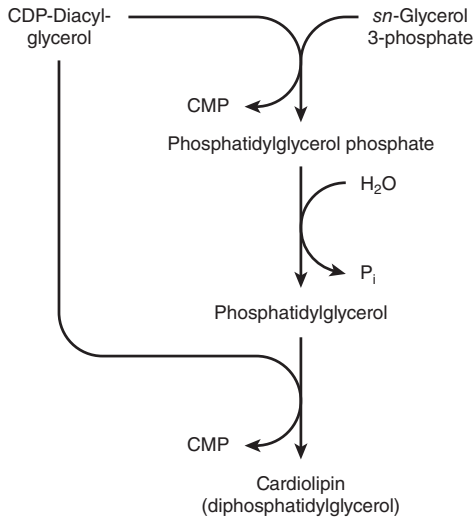

FIGURE 24-3 Biosynthesis of cardiolipin.

Cardiolipin (diphosphatidylglycerol; Figure 21-10) is a phospholipid present in mitochondria. It is formed from phosphatidylglycerol, which in turn is synthesized from CDP-diacylglycerol (Figure 24-2) and glycerol 3-phosphate according to the scheme shown in **Figure 24-3**. Cardiolipin, found in the inner membrane of mitochondria, has a key role in mitochondrial structure and function, and is also thought to be involved in programmed cell death (**apoptosis**).

Biosynthesis of Glycerol Ether Phospholipids

In **glycerol ether phospholipids**, one or more of the glycerol carbons is attached to a hydrocarbon chain by an ether linkage rather than an ester bond. **Plasmalogens** and **platelet activating factor** are important examples of this type of lipid. The biosynthetic pathway is located in peroxisomes. Dihydroxyacetone phosphate is the precursor of the glycerol moiety (**Figure 24-4**). It combines with acyl-CoA to give 1-acyldihydroxyacetone

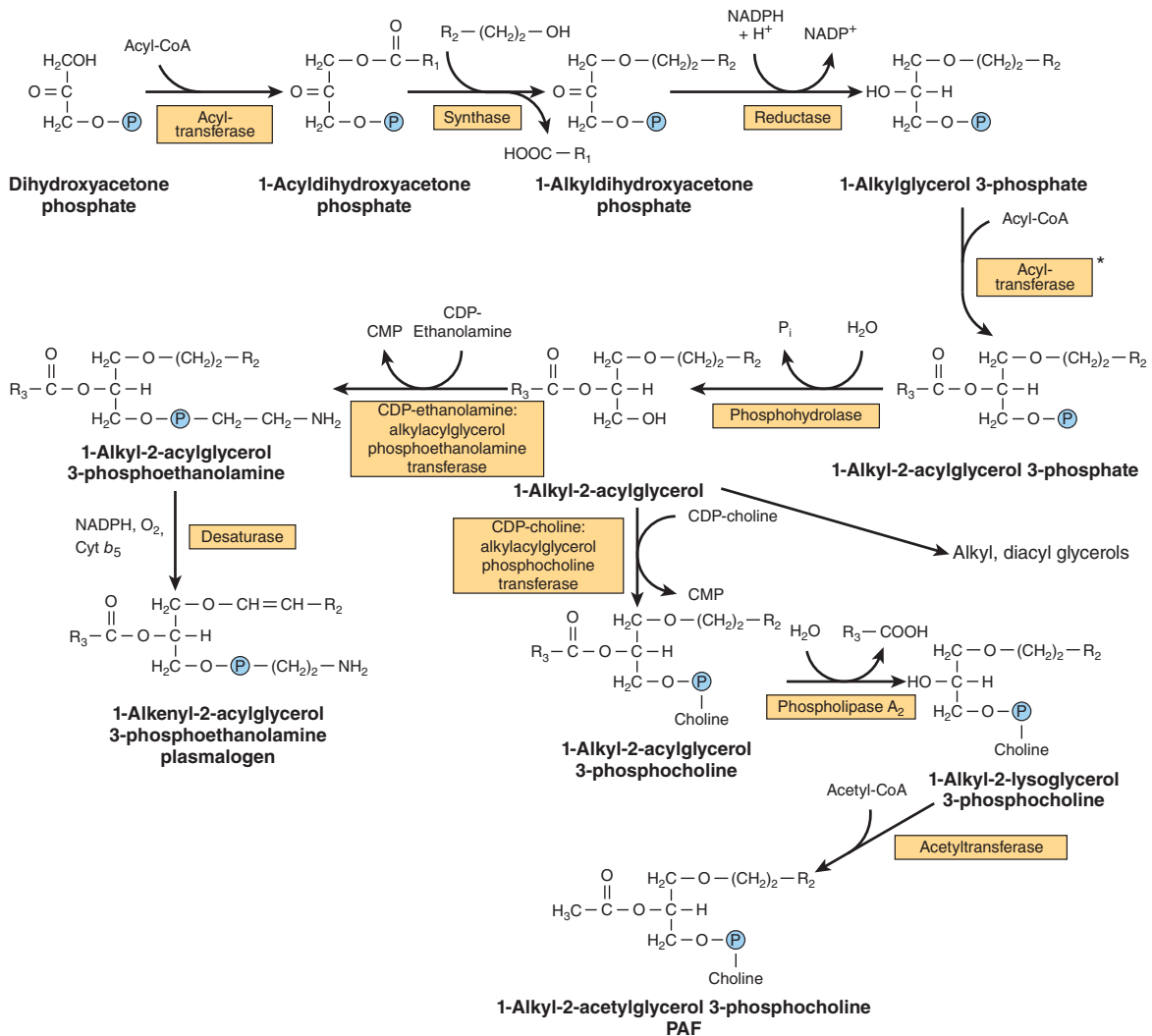

FIGURE 24-4 Biosynthesis of ether lipids, including plasmalogens, and platelet-activating factor (PAF). In the de novo pathway for PAF synthesis, acetyl-CoA is incorporated at stage*, avoiding the last two steps in the pathway shown here.

phosphate, and the ether link is formed in the next reaction, producing 1-alkyldihydroxyacetone phosphate, which is then converted to 1-alkylglycerol 3-phosphate. After further acylation in the 2 position, the resulting 1-alkyl-2-acylglycerol 3-phosphate (analogous to phosphatidate in Figure 24–2) is hydrolyzed to give the free glycerol derivative. Plasmalogens, which comprise much of the phospholipid in mitochondria, are formed by desaturation of the analogous 3-phosphoethanolamine derivative (Figure 24–4). Platelet-activating factor (PAF) (1-alkyl-2-acetyl-*sn*-glycerol-3-phosphocholine) is synthesized from the corresponding 3-phosphocholine derivative. It is formed by many blood cells and other tissues and aggregates platelets at concentrations as low as 10^{-11} mol/L. It also has hypotensive and ulcerogenic properties and is involved in a variety of biologic responses, including inflammation, chemotaxis, and protein phosphorylation.

Phospholipases Allow Degradation & Remodeling of Phosphoglycerols

Although phospholipids are actively degraded, each portion of the molecule turns over at a different rate—eg, the turnover time of the phosphate group is different from that of the 1-acyl group. This is due to the presence of enzymes that allow partial degradation followed by resynthesis (Figure 24–5). **Phospholipase A₂** catalyzes the hydrolysis of glycerophospholipids to form a free fatty acid and lysophospholipid, which in turn may be reacylated by acyl-CoA in the presence of an acyltransferase. Alternatively, lysophospholipid (eg, lysolecithin) is attacked by **lysophospholipase**, forming the corresponding glyceryl phosphoryl base, which may then be split by a hydrolase liberating glycerol 3-phosphate plus base. **Phospholipases A₁, A₂, B, C, and D** attack the bonds indicated in Figure 24–6. **Phospholipase A₂** is found in pancreatic fluid and snake venom as well as in many types of cells; **phospholipase C** is one of the major toxins secreted by bacteria; and **phospholipase D** is known to be involved in mammalian signal transduction.

Lysolecithin (lysophosphatidylcholine) may be formed by an alternative route that involves **lecithin: cholesterol acyltransferase (LCAT)**. This enzyme, found in plasma, catalyzes the transfer of a fatty acid residue from the 2 position of lecithin to cholesterol to form cholesteryl ester and lysolecithin, and is considered to be responsible for much of the cholesteryl ester in plasma lipoproteins (see Chapter 25).

Long-chain saturated fatty acids are found predominantly in the 1 position of phospholipids, whereas the polyunsaturated fatty acids (eg, the precursors of prostaglandins) are incorporated more frequently into the 2 position. The incorporation of fatty acids into lecithin occurs in three ways; by complete synthesis of the phospholipid; by transacylation between cholesteryl ester and lysolecithin; and by direct acylation of lysolecithin by acyl-CoA. Thus, a continuous exchange of the fatty acids is possible, particularly with regard to introducing essential fatty acids into phospholipid molecules.

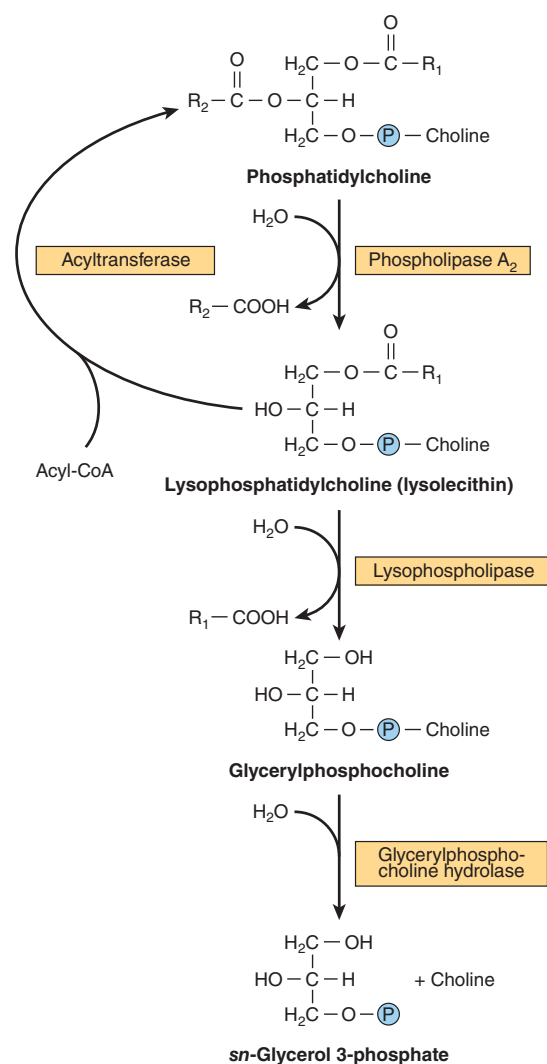

FIGURE 24–5 Metabolism of phosphatidylcholine (lecithin).

ALL SPHINGOLIPIDS ARE FORMED FROM CERAMIDE

Ceramide (see Chapter 21) is synthesized in the endoplasmic reticulum from the amino acid serine as shown in Figure 24–7. Ceramide is an important signaling molecule (second messenger) regulating pathways including programmed cell death

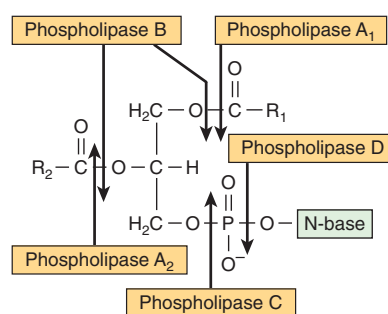

FIGURE 24–6 Sites of the hydrolytic activity of phospholipases on a phospholipid substrate.

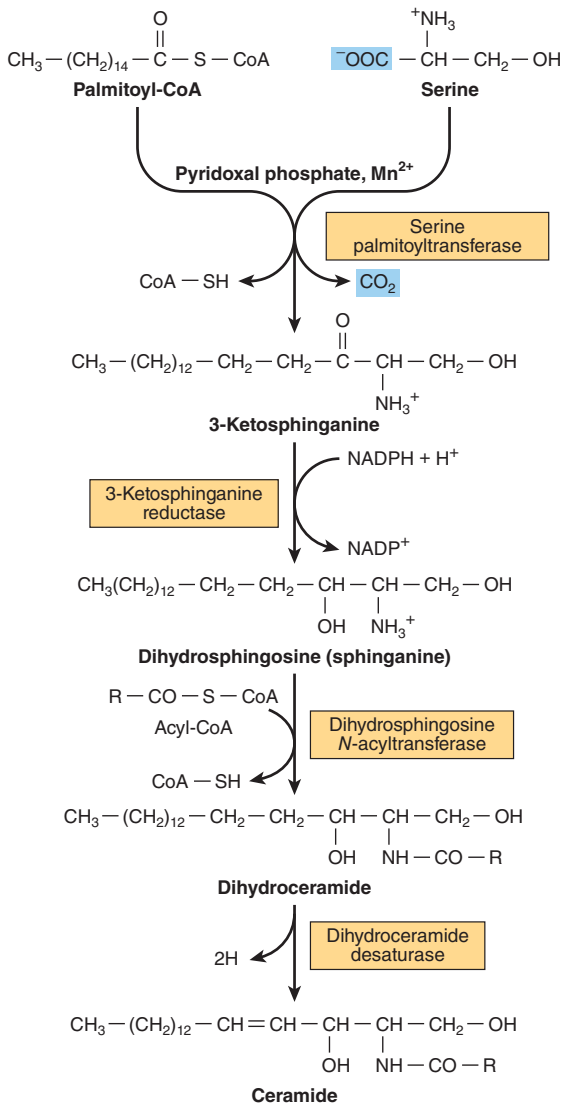

FIGURE 24-7 Biosynthesis of ceramide.

(apoptosis), the cell cycle, and cell differentiation and senescence.

Sphingomyelins (see Figure 21-11) are phospholipids and are formed when ceramide reacts with phosphatidylcholine to form sphingomyelin plus diacylglycerol (Figure 24-8A). This occurs mainly in the Golgi apparatus and to a lesser extent in the plasma membrane.

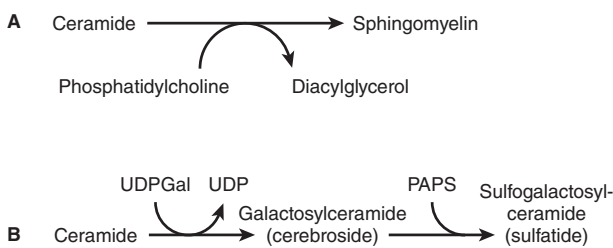

FIGURE 24-8 Biosynthesis of (A) sphingomyelin, (B) galactosylceramide and its sulfo derivative. (PAPS, “active sulfate,” adenosine 3'-phosphate-5'-phosphosulfate.)

Glycosphingolipids Are a Combination of Ceramide With One or More Sugar Residues

The simplest glycosphingolipids (**cerebrosides**) are **galactosylceramide (GalCer)** (see Figure 21-15) and **glucosylceramide (GlcCer)**. GalCer is a major lipid of **myelin**, whereas GlcCer is the major glycosphingolipid of **extraneural tissues** and a precursor of most of the more complex glycosphingolipids. GalCer (Figure 24-8B) is formed in a reaction between ceramide and UDPGal (formed by epimerization from UDPGlc—Figure 20-6).

Sulfo galactosylceramide and other sulfolipids such as the **sulfo(galacto)-glycerolipids** and the **steroid sulfates** are formed after further reactions involving 3'-phosphoadenosine-5'-phosphosulfate (PAPS; “active sulfate”). **Gangliosides** are synthesized from ceramide by the stepwise addition of activated sugars (eg, UDPGlc and UDPGal) and a **sialic acid**, usually *N*-acetylneuraminic acid (Figure 24-9). A large number of gangliosides of increasing molecular weight may be formed. Most of the enzymes transferring sugars from nucleotide sugars (glycosyl transferases) are found in the Golgi apparatus.

Glycosphingolipids are constituents of the outer leaflet of plasma membranes and are important in **cell adhesion** and **cell recognition**. Some are antigens, for example, ABO blood group substances. Certain gangliosides function as receptors for bacterial toxins (eg, for **cholera toxin**, which subsequently activates adenyl cyclase).

CLINICAL ASPECTS

Deficiency of Lung Surfactant Causes Respiratory Distress Syndrome

Lung surfactant is composed mainly of lipid with some proteins and carbohydrate and prevents the alveoli from collapsing. The phospholipid **dipalmitoyl-phosphatidylcholine** decreases surface tension at the air-liquid interface and thus greatly reduces the work of breathing, but other surfactant lipid and protein components are also important in surfactant function. Deficiency of lung surfactant in the lungs of many preterm newborns gives rise to **infant respiratory distress syndrome (IRDS)**. Administration of either natural or artificial surfactant is of therapeutic benefit.

Phospholipids & Sphingolipids Are Involved in Multiple Sclerosis and Lipidoses

Certain diseases are characterized by abnormal quantities of these lipids in the tissues, often in the nervous system. They may be classified into two groups: (1) true demyelinating diseases and (2) sphingolipidoses.

In **multiple sclerosis**, which is a demyelinating disease, there is loss of both phospholipids (particularly ethanolamine plasmalogen) and of sphingolipids from white matter. Thus, the

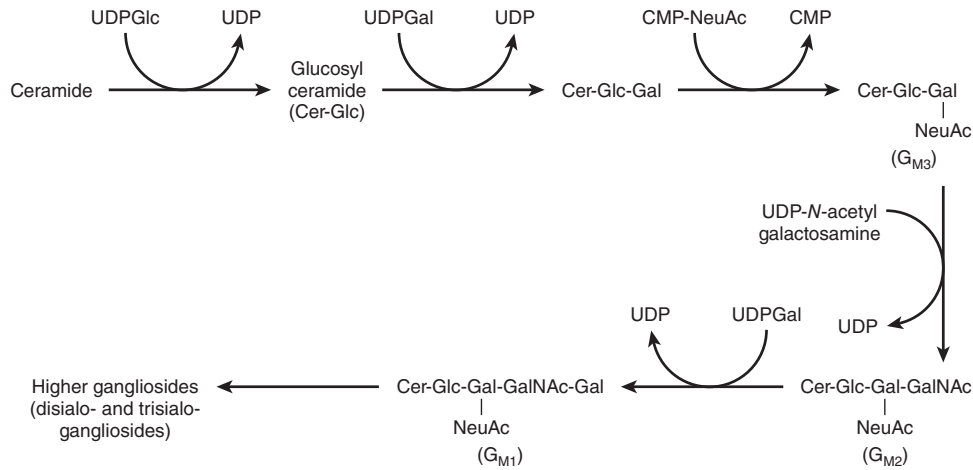

FIGURE 24-9 Biosynthesis of gangliosides. (NeuAc, *N*-acetylneuraminic acid.)

lipid composition of white matter resembles that of gray matter. The cerebrospinal fluid shows raised phospholipid levels.

The **sphingolipidoses (lipid storage diseases)** are a group of inherited diseases that are caused by a genetic defect in the catabolism of lipids containing sphingosine. They are part of a larger group of lysosomal disorders and exhibit several constant features: (1) complex lipids containing ceramide accumulate in cells, particularly neurons, causing neurodegeneration and shortening the lifespan. (2) The rate of **synthesis** of the stored lipid is normal. (3) The enzymatic defect is in the **lysosomal degradation pathway** of sphingolipids. (4) The extent to which the activity of the affected enzyme is decreased is similar in all tissues. There is

no effective treatment for many of the diseases, although some success has been achieved with **enzyme replacement therapy** and **bone marrow transplantation** in the treatment of Gaucher and Fabry diseases. Other promising approaches are **substrate deprivation therapy** to inhibit the synthesis of sphingolipids and **chemical chaperone therapy**. **Gene therapy** for lysosomal disorders is also currently under investigation. Some examples of the more important lipid storage diseases are shown in **Table 24-1**.

Multiple sulfatase deficiency results in accumulation of sulfogalactosylceramide, steroid sulfates, and proteoglycans owing to a combined deficiency of arylsulfatases A, B, and C and steroid sulfatase.

TABLE 24-1 Examples of Sphingolipidoses

Disease	Enzyme Deficiency	Lipid Accumulating	Clinical Symptoms
Tay-Sachs disease	Hexosaminidase A	Cer—Glc—Gal(NeuAc)— \ddagger GalNAc G_{M2} Ganglioside	Mental retardation, blindness, muscular weakness
Fabry disease	α -Galactosidase	Cer—Glc—Gal— \ddagger Gal Globotriaosylceramide	Skin rash, kidney failure (full symptoms only in males; X-linked recessive)
Metachromatic leukodystrophy	Arylsulfatase A	Cer—Gal— \ddagger OSO ₃ 3-Sulfogalactosylceramide	Mental retardation and psychologic disturbances in adults; demyelination
Krabbe disease	β -Galactosidase	Cer— \ddagger Gal Galactosylceramide	Mental retardation; myelin almost absent
Gaucher disease	β -Glucosidase	Cer— \ddagger Glc Glucosylceramide	Enlarged liver and spleen, erosion of long bones, mental retardation in infants
Niemann-Pick disease	Sphingomyelinase	Cer— \ddagger P—choline Sphingomyelin	Enlarged liver and spleen, mental retardation; fatal in early life
Farber disease	Ceramidase	Acyl— \ddagger Sphingosine Ceramide	Hoarseness, dermatitis, skeletal deformation, mental retardation; fatal in early life

Abbreviations: Cer, ceramide; Gal, galactose; Glc, glucose; NeuAc, *N*-acetylneuraminic acid; \ddagger , site of deficient enzyme reaction.

SUMMARY

- Triacylglycerols are the major energy-storing lipids, whereas phosphoglycerols, sphingomyelin, and glycosphingolipids are amphipathic and have structural functions in cell membranes as well as other specialized roles.
- Triacylglycerols and some phosphoglycerols are synthesized by progressive acylation of glycerol-3-phosphate. The pathway bifurcates at phosphatidate, forming inositol phospholipids and cardiolipin on the one hand and triacylglycerol and choline and ethanolamine phospholipids on the other.
- Plasmalogens and platelet-activating factor (PAF) are ether phospholipids formed from dihydroxyacetone phosphate.
- Sphingolipids are formed from ceramide (*N*-acylsphingosine). Sphingomyelin is present in membranes of organelles involved in secretory processes (eg, Golgi apparatus). The simplest glycosphingolipids are a combination of ceramide plus a sugar residue (eg, GalCer in myelin). Gangliosides are more complex glycosphingolipids containing more sugar residues plus sialic acid. They are present in the outer layer of the plasma membrane, where they contribute to the glycocalyx and are important as antigens and cell receptors.
- Phospholipids and sphingolipids are involved in several disease processes, including infant respiratory distress syndrome (lack of lung surfactant), multiple sclerosis (demyelination), and sphingolipidoses (inability to break down sphingolipids in lysosomes due to inherited defects in hydrolase enzymes).

REFERENCES

- Goss V, Hunt AN, Postle AD: Regulation of lung surfactant phospholipid synthesis and metabolism. *Biochim Biophys Acta* 2013;1831:448.
- McPhail LC: Glycerolipid in signal transduction. *Biochemistry of Lipids, Lipoproteins and Membranes*, 4th ed. Vance DE, Vance JE (editors). Elsevier, 2002:315–340.
- Merrill AH: Sphingolipids. *Biochemistry of Lipids, Lipoproteins and Membranes*, 5th ed. Vance DE, Vance JE (editors). Elsevier, 2008:363–398.
- Reue K, Brindley DN: Thematic review series: glycerolipids. Multiple roles for lipins/phosphatidate phosphatase enzymes in lipid metabolism. *J Lipid Res* 2008;49:2493
- Ruvolo PP: Intracellular signal transduction pathways activated by ceramide and its metabolites. *Pharmacol Res* 2003;47:383.
- Shimizu T: Lipid mediators in health and disease: enzymes and receptors as therapeutic targets for the regulation of immunity and inflammation. *Annu Rev Pharmacol Toxicol* 2009;49:123.
- Scriver CR, Beaudet AL, Sly WS, et al (editors): *The Metabolic and Molecular Bases of Inherited Disease*, 8th ed. McGraw-Hill, 2001.
- Vance DE, Vance JE (editors): Phospholipid biosynthesis in eukaryotes. In: *Biochemistry of Lipids, Lipoproteins and Membranes*, 5th ed. Elsevier, 2008:213–244.
- Yen CL, Stone SJ, Koliwad S, et al: Thematic review series: glycerolipids. DGAT enzymes and triacylglycerol biosynthesis. *J Lipid Res* 2008;49:2283.
- Yu RK, Tsai YT, Ariga T, et al: Structures, biosynthesis and functions of gangliosides- an overview. *J Oleo Sci* 2011;60:537.

Lipid Transport & Storage

Kathleen M. Botham, PhD, DSc & Peter A. Mayes, PhD, DSc

OBJECTIVES

After studying this chapter, you should be able to:

- Identify the four major groups of plasma lipoproteins and the four major lipid classes they carry.
- Illustrate the structure of a lipoprotein particle.
- Indicate the major types of apolipoprotein found in the different lipoprotein classes.
- Explain that triacylglycerol is carried from the intestine (after intake from the diet) to the liver in chylomicrons and from the liver to extrahepatic tissues in very low density lipoprotein (VLDL), and these particles are synthesized in intestinal and liver cells, respectively, by similar processes.
- Illustrate the processes by which chylomicrons are metabolized by lipases to form chylomicron remnants, which are then removed from the circulation by the liver.
- Explain how VLDL is metabolized by lipases to VLDL remnants (also called intermediate-density lipoprotein [IDL]) which may be cleared by the liver or converted to low-density lipoprotein (LDL), which functions to deliver cholesterol from the liver to extrahepatic tissues and is taken up via the LDL (apoB100,E) receptor.
- Explain how high-density lipoprotein (HDL), which returns cholesterol from extrahepatic tissues to the liver in reverse cholesterol transport, is synthesized, indicate the mechanisms by which it accepts cholesterol from tissues, and show how it is metabolized in the HDL cycle.
- Understand how the liver plays a central role in lipid transport and metabolism and how hepatic VLDL secretion is regulated by the diet and hormones.
- Be aware of the roles of LDL and HDL in promoting and retarding, respectively, the development of atherosclerosis.
- Indicate the causes of alcoholic and nonalcoholic fatty liver disease.
- Appreciate that adipose tissue is the main store of triacylglycerol in the body and explain the processes by which fatty acids are released and how they are regulated.
- Understand the role of brown adipose tissue in the generation of body heat.

BIOMEDICAL IMPORTANCE

Fat absorbed from the diet and lipids synthesized by the liver and adipose tissue must be transported between the various tissues and organs for utilization and storage. Since lipids are insoluble in water, the problem of how to transport them in the aqueous blood plasma is solved by associating nonpolar lipids (triacylglycerol and cholesteryl esters) with amphipathic

lipids (phospholipids and cholesterol) and proteins to make **water-miscible lipoproteins**.

In a meal-eating omnivore such as the human, excess calories are ingested in the anabolic phase of the feeding cycle, followed by a period of negative caloric balance when the organism draws upon its carbohydrate and fat stores. Lipoproteins mediate this cycle by transporting lipids from the intestines as **chylomicrons**—and from the liver as **very low density**

TABLE 25-1 Composition of the Lipoproteins in Plasma of Humans

Lipoprotein	Source	Diameter (nm)	Density (g/mL)	Composition		Main Lipid Components	Apolipoproteins
				Protein (%)	Lipid (%)		
Chylomicrons	Intestine	90-1000	<0.95	1-2	98-99	Triacylglycerol	A-I, A-II, A-IV, ^a B-48, C-I, C-II, C-III, E
Chylomicron remnants	Chylomicrons	45-150	<1.006	6-8	92-94	Triacylglycerol, phospholipids, cholesterol	B-48, E
VLDL	Liver (intestine)	30-90	0.95-1.006	7-10	90-93	Triacylglycerol	B-100, C-I, C-II, C-III
IDL	VLDL	25-35	1.006-1.019	11	89	Triacylglycerol, cholesterol	B-100, E
LDL	VLDL	20-25	1.019-1.063	21	79	Cholesterol	B-100
HDL	Liver, intestine, VLDL, chylomicrons					Phospholipids, cholesterol	A-I, A-II, A-IV, C-I, C-II, C-III, D, ^b E
HDL ₁		20-25	1.019-1.063	32	68		
HDL ₂		10-20	1.063-1.125	33	67		
HDL ₃		5-10	1.125-1.210	57	43		
Pre β -HDL ^c		<5	>1.210				A-I
Albumin/free fatty acids	Adipose tissue		>1.281	99	1	Free fatty acids	

^aSecreted with chylomicrons but transfers to HDL.

^bAssociated with HDL₂ and HDL₃ subfractions.

^cPart of a minor fraction known as very high density lipoproteins (VHDL).

Abbreviations: HDL, high-density lipoproteins; IDL, intermediate-density lipoproteins; LDL, low-density lipoproteins; VLDL, very low density lipoproteins.

lipoproteins (VLDL)—to most tissues for oxidation and to adipose tissue for storage. Lipid is mobilized from adipose tissue as free fatty acids (FFAs) bound to serum albumin. Abnormalities of lipoprotein metabolism cause various **hypo-** or **hyperlipoproteinemias**. The most common of these is in **diabetes mellitus**, where insulin deficiency causes excessive mobilization of FFA and underutilization of chylomicrons and VLDL, leading to **hypertriacylglycerolemia**. Most other pathologic conditions affecting lipid transport are due primarily to inherited defects, some of which cause **hypercholesterolemia** and premature **atherosclerosis** (see Table 26-1). **Obesity**—particularly abdominal obesity—is a risk factor for increased mortality, hypertension, type 2 diabetes mellitus, hyperlipidemia, hyperglycemia, and various endocrine dysfunctions.

LIPIDS ARE TRANSPORTED IN THE PLASMA AS LIPOPROTEINS

Four Major Lipid Classes Are Present in Lipoproteins

Plasma lipids consist of **triacylglycerols** (16%), **phospholipids** (30%), **cholesterol** (14%), and **cholesteryl esters** (36%) and a much smaller fraction of unesterified long-chain fatty acids (free fatty acids or FFA) (4%). This latter fraction, the FFA, is metabolically the most active of the plasma lipids.

Four Major Groups of Plasma Lipoproteins Have Been Identified

Since fat is less dense than water, the density of a lipoprotein decreases as the proportion of lipid to protein increases (Table 25-1). Four major groups of lipoproteins have been identified that are important physiologically and in clinical diagnosis. These are (1) **chylomicrons**, derived from intestinal absorption of triacylglycerol and other lipids; (2) **very low density lipoproteins** (VLDL), derived from the liver for the export of triacylglycerol; (3) **low-density lipoproteins** (LDL), representing a final stage in the catabolism of VLDL; and (4) **high-density lipoproteins** (HDL), involved in cholesterol transport and also in VLDL and chylomicron metabolism. Triacylglycerol is the predominant lipid in chylomicrons and VLDL, whereas cholesterol and phospholipid are the predominant lipids in LDL and HDL, respectively (Table 25-1). Lipoproteins may also be classified according to their electrophoretic properties into α - (HDL), β - (LDL), and **pre- β** (VLDL)-lipoproteins.

Lipoproteins Consist of a Nonpolar Core & a Single Surface Layer of Amphipathic Lipids

The **nonpolar lipid core** consists of mainly **triacylglycerol** and **cholesteryl ester** and is surrounded by a **single surface layer** of **amphipathic phospholipid** and **cholesterol** molecules

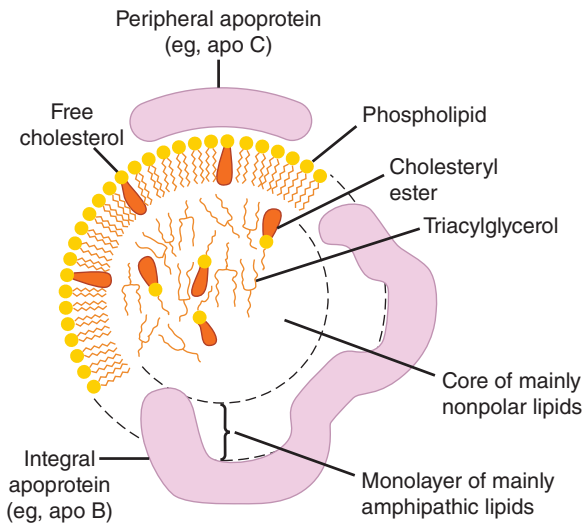

FIGURE 25-1 Generalized structure of a plasma lipoprotein.

The similarities with the structure of the plasma membrane are to be noted. Small amounts of cholesteryl ester and triacylglycerol are found in the surface layer and a little free cholesterol in the core.

(Figure 25-1). These are oriented so that their polar groups face outward to the aqueous medium, as in the cell membrane (see Chapters 21 and 40). The protein moiety of a lipoprotein is known as an **apolipoprotein** or **apoprotein**, constituting nearly 70% of some HDL and as little as 1% of chylomicrons.

The Distribution of Apolipoproteins Characterizes the Lipoprotein

One or more apolipoproteins (proteins or polypeptides) are present in each lipoprotein. They are usually abbreviated as apo followed by the letter A, B, C, etc (Table 25-1). Some apolipoproteins are integral and cannot be removed (eg, apo B), whereas others are bound to the surface and are free to transfer to other lipoproteins, eg, apos C and E). The major apolipoproteins of HDL (α -lipoprotein) are apoAs (Table 25-1). The main apolipoprotein of LDL (β -lipoprotein) is apo B (B-100), which is found also in VLDL. Chylomicrons contain a truncated form of apo B (B-48) that is synthesized in the intestine, while B-100 is synthesized in the liver. Apo B-100 is one of the longest single polypeptide chains known, having 4536 amino acids and a molecular mass of 550,000 Da. Apo B-48 (48% of B-100) is formed after transcription of the apo B-100 gene by the introduction of a stop signal into the mRNA transcript by an RNA editing enzyme. Apos C-I, C-II, and C-III are smaller polypeptides (molecular mass 7000-9000 Da) freely transferable between several different lipoproteins. Apo E, found in VLDL, HDL, chylomicrons, and chylomicron remnants, is also freely transferable; it accounts for 5% to 10% of total VLDL apolipoproteins in normal subjects.

Apolipoproteins carry out several roles: (1) they can form part of the structure of the lipoprotein, for example, apo B; (2) they are enzyme cofactors, for example, C-II for lipoprotein lipase, A-I for lecithin:cholesterol acyltransferase, or enzyme inhibitors, for example, apo A-II and apo C-III for lipoprotein lipase, apo C-I for cholesteryl ester transfer protein; and (3) they

act as ligands for interaction with lipoprotein receptors in tissues, for example, apo B-100 and apo E for the LDL receptor, apo E for the LDL-receptor-related protein-1 (LRP-1), which has been identified as the remnant receptor, and apo A-I for the HDL receptor. The functions of apo A-IV and apo D, however, are not yet clearly defined, although apo D is believed to be an important factor in human neurodegenerative disorders.

FREE FATTY ACIDS ARE RAPIDLY METABOLIZED

The FFAs (also termed nonesterified fatty acids [NEFAs] or unesterified fatty acids) arise in the plasma from the breakdown of triacylglycerol in adipose tissue or as a result of the action of lipoprotein lipase on the plasma triacylglycerols. They are found **in combination with albumin**, a very effective solubilizer, in concentrations varying between 0.1 and 2.0 $\mu\text{eq/mL}$ of plasma. Levels are low in the fully fed condition and rise to 0.7 to 0.8 $\mu\text{eq/mL}$ in the starved state. In uncontrolled **diabetes mellitus**, the level may rise to as much as 2 $\mu\text{eq/mL}$.

FFAs are removed from the blood extremely rapidly and oxidized (fulfilling 25%-50% of energy requirements in starvation) or esterified to form triacylglycerol in the tissues. In starvation, esterified lipids from the circulation or in the tissues are oxidized as well, particularly in heart and skeletal muscle cells, where considerable stores of lipid are to be found.

The FFA uptake by tissues is related directly to the plasma-FFA concentration, which in turn is determined by the rate of lipolysis in adipose tissue. After dissociation of the fatty acid-albumin complex at the plasma membrane, fatty acids bind to a **membrane fatty acid transport protein** that acts as a transmembrane cotransporter with Na^+ . On entering the cytosol, FFAs are bound by intracellular **fatty-acid-binding proteins**. The role of these proteins in intracellular transport is thought to be similar to that of serum albumin in extracellular transport of long-chain fatty acids.

TRIACYLGLYCEROL IS TRANSPORTED FROM THE INTESTINES IN CHYLOMICRONS & FROM THE LIVER IN VERY LOW DENSITY LIPOPROTEINS

By definition, **chylomicrons** are found in **chyle** formed only by the lymphatic system **draining the intestine**. They are responsible for the transport of all dietary lipids into the circulation. Small quantities of VLDL are also to be found in chyle; however, most **VLDL in the plasma** are of hepatic origin. **They are the vehicles of transport of triacylglycerol from the liver to the extrahepatic tissues.**

There are striking similarities in the mechanisms of formation of chylomicrons by intestinal cells and of VLDL by

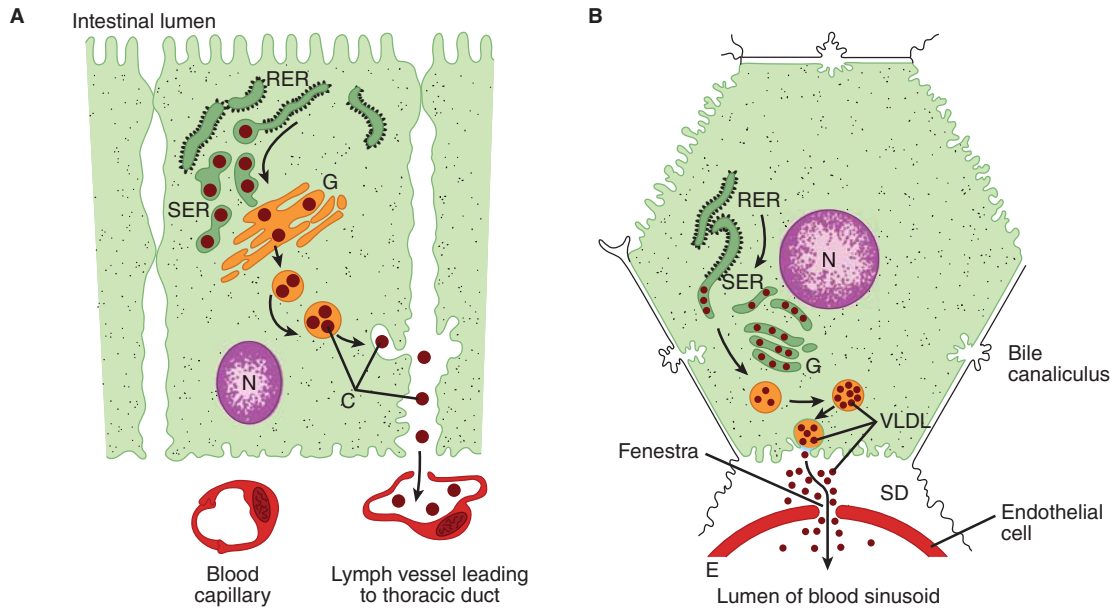

FIGURE 25-2 The formation and secretion of (A) chylomicrons by an intestinal cell and (B) very low density lipoproteins by a hepatic cell. (C, chylomicrons; E, endothelium; G, Golgi apparatus; N, nucleus; RER, rough endoplasmic reticulum; SD, space of Disse, containing blood plasma; SER, smooth endoplasmic reticulum; VLDL, very low density lipoproteins.) Apolipoprotein B, synthesized in the RER, is incorporated into particles with triacylglycerol, cholesterol, and phospholipids in the SER. After the addition of carbohydrate residues in G, they are released from the cell by reverse pinocytosis. Chylomicrons pass into the lymphatic system. VLDL are secreted into the space of Disse and then into the hepatic sinusoids through fenestrae in the endothelial lining.

hepatic parenchymal cells (Figure 25-2), perhaps because—apart from the mammary gland—the intestine and liver are the only tissues from which particulate lipid is secreted. Newly secreted or “nascent” chylomicrons and VLDL contain only a small amount of apolipoproteins C and E, and the full comple-

ment is acquired from HDL in the circulation (Figures 25-3 and 25-4). Apo B, however, is an integral part of the lipoprotein particles, it is incorporated into the particles during their assembly inside the cells and is essential for chylomicron and VLDL formation. In **abetalipoproteinemia** (a rare disease),

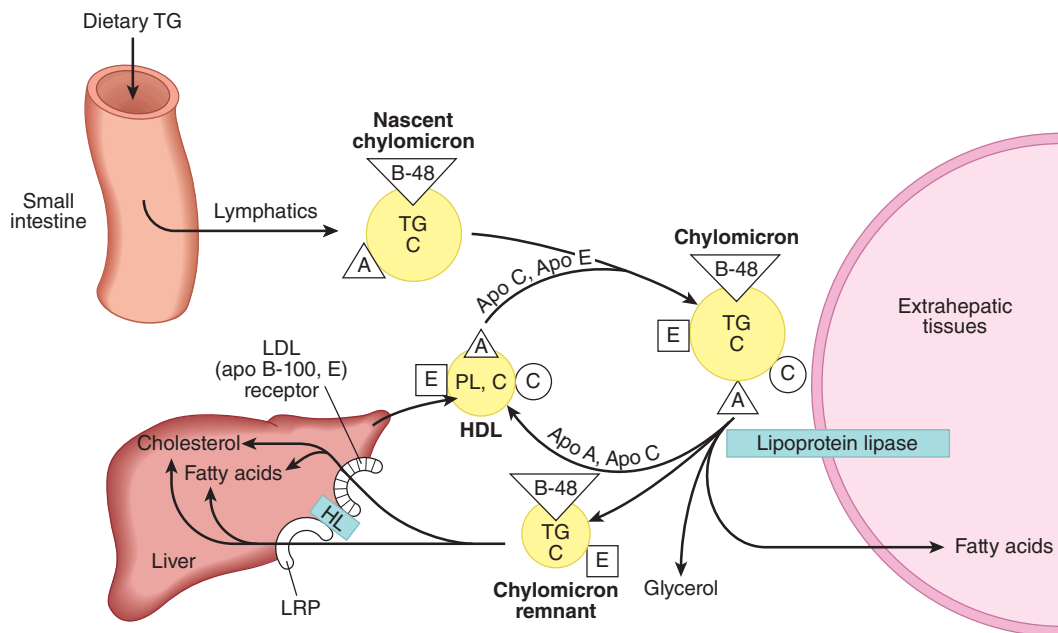

FIGURE 25-3 Metabolic fate of chylomicrons. (A, apolipoprotein A; B-48, apolipoprotein B-48; C, apolipoprotein C; C, cholesterol and cholesteryl ester; E, apolipoprotein E; HDL, high-density lipoprotein; HL, hepatic lipase; LRP, LDL-receptor-related protein; PL, phospholipid; TG, triacylglycerol.) Only the predominant lipids are shown.

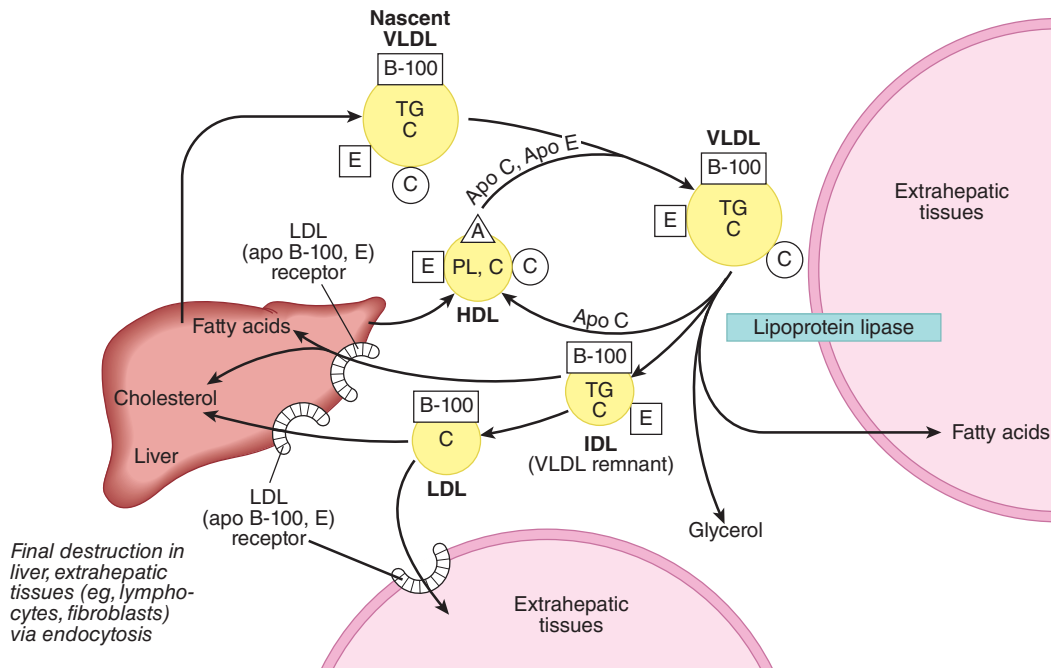

FIGURE 25-4 Metabolic fate of very low density lipoproteins (VLDL) and production of low-density lipoproteins (LDL). (A, apolipoprotein A; B-100, apolipoprotein B-100; C, apolipoprotein C; C, cholesterol and cholesteryl ester; E, apolipoprotein E; HDL, high-density lipoprotein; IDL, intermediate-density lipoprotein; PL, phospholipid; TG, triacylglycerol.) Only the predominant lipids are shown. It is possible that some IDL is also metabolized via the low density lipoprotein receptor-related protein-1 (LRP-1.)

lipoproteins containing apo B are not formed and lipid droplets accumulate in the intestine and liver.

A more detailed account of the factors controlling hepatic VLDL secretion is given below.

CHYLOMICRONS & VERY LOW DENSITY LIPOPROTEINS ARE RAPIDLY CATABOLIZED

The clearance of chylomicrons from the blood is rapid, the half-time of disappearance being under 1 hour in humans. Larger particles are catabolized more quickly than smaller ones. Fatty acids originating from chylomicron triacylglycerol are delivered mainly to adipose tissue, heart, and muscle (80%), while ~20% goes to the liver. However, **the liver does not metabolize native chylomicrons or VLDL significantly**; thus, the fatty acids in the liver must be secondary to their metabolism in extrahepatic tissues.

Triacylglycerols of Chylomicrons & VLDL Are Hydrolyzed by Lipoprotein Lipase to Form Remnant Lipoproteins

Lipoprotein lipase is located on the walls of blood capillaries, anchored to the endothelium by negatively charged proteoglycan chains of heparan sulfate. It has been found in heart, adipose tissue, spleen, lung, renal medulla, aorta, diaphragm, and lactating mammary gland, although it is not active in adult liver. It is not normally found in blood; however, following

injection of **heparin**, lipoprotein lipase is released from its heparan sulfate binding sites into the circulation. **Hepatic lipase** is bound to the sinusoidal surface of liver cells and is also released by heparin. This enzyme, however, does not react readily with chylomicrons or VLDL but is involved in chylomicron remnant and HDL metabolism.

Both **phospholipids** and **apo C-II** are required as cofactors for lipoprotein lipase activity, while **apo A-II** and **apo C-III** act as inhibitors. Hydrolysis takes place while the lipoproteins are attached to the enzyme on the endothelium. Triacylglycerol is hydrolyzed progressively through a diacylglycerol to a monoacylglycerol and finally to FFA plus glycerol. Some of the released FFA return to the circulation, attached to albumin, but the bulk is transported into the tissue (Figures 25-3 and 25-4). Heart lipoprotein lipase has a low K_m for triacylglycerol, about one-tenth of that for the enzyme in adipose tissue. This enables the delivery of fatty acids from triacylglycerol to be **redirected from adipose tissue to the heart in the starved state** when the plasma triacylglycerol decreases. A similar redirection to the mammary gland occurs during lactation, allowing uptake of lipoprotein triacylglycerol fatty acid for **milk fat** synthesis. The **VLDL receptor** plays an important part in the delivery of fatty acids from VLDL triacylglycerol to adipocytes by binding VLDL and bringing it into close contact with lipoprotein lipase. In adipose tissue, **insulin** enhances lipoprotein lipase synthesis in adipocytes and its translocation to the luminal surface of the capillary endothelium.

Reaction with lipoprotein lipase results in the loss of 70% to 90% of the triacylglycerol of chylomicrons and in the loss of apo C (which returns to HDL) but not apo E, which is retained.

The resulting **chylomicron remnant** is about half the diameter of the parent chylomicron and is relatively enriched in cholesterol and cholesteryl esters because of the loss of triacylglycerol (Figure 25–3). Similar changes occur to VLDL, with the formation of **VLDL remnants** (also called **intermediate-density lipoprotein (IDL)**) (Figure 25–4).

The Liver Is Responsible for the Uptake of Remnant Lipoproteins

Chylomicron remnants are taken up by the liver by receptor-mediated endocytosis, and the cholesteryl esters and triacylglycerols are hydrolyzed and metabolized. Uptake is mediated by **apo E** (Figure 25–3), via two apo E-dependent receptors, the **LDL (apo B-100, E) receptor** and **LRP-1 (LDL receptor-related protein-1)**. Hepatic lipase has a dual role: (1) it acts as a ligand to facilitate remnant uptake and (2) it hydrolyzes remnant triacylglycerol and phospholipid.

After metabolism to IDL, VLDL may be taken up by the liver directly via the LDL (apo B-100, E) receptor, or it may be converted to LDL. Only one molecule of apo B-100 is present in each of these lipoprotein particles, and this is conserved during the transformations. Thus, each LDL particle is derived from a single precursor VLDL particle (Figure 25–4). In humans, a relatively large proportion of IDL forms LDL, accounting for the increased concentrations of LDL in humans compared with many other mammals.

LDL IS METABOLIZED VIA THE LDL RECEPTOR

The liver and many extrahepatic tissues express the **LDL (apo B-100, E) receptor**. It is so designated because it is specific for apo B-100 but not B-48, which lacks the carboxyl terminal domain of B-100 containing the LDL receptor ligand, and it also takes up lipoproteins rich in apo E. Approximately 30% of LDL is degraded in extrahepatic tissues and 70% in the liver. A positive correlation exists between the incidence of **atherosclerosis** and the plasma concentration of LDL cholesterol. The LDL (apoB-100, E) receptor is defective in **familial hypercholesterolemia**, a genetic condition which blood LDL cholesterol levels are increased, causing premature atherosclerosis (Table 26–1). For further discussion of the regulation of the LDL receptor, see Chapter 26.

HDL TAKES PART IN BOTH LIPOPROTEIN TRIACYLGLYCEROL & CHOLESTEROL METABOLISM

HDL is synthesized and secreted from both liver and intestine (Figure 25–5). However, apo C and apo E are synthesized in the liver and transferred from liver HDL to intestinal HDL when the latter enters the plasma. A major function of HDL is

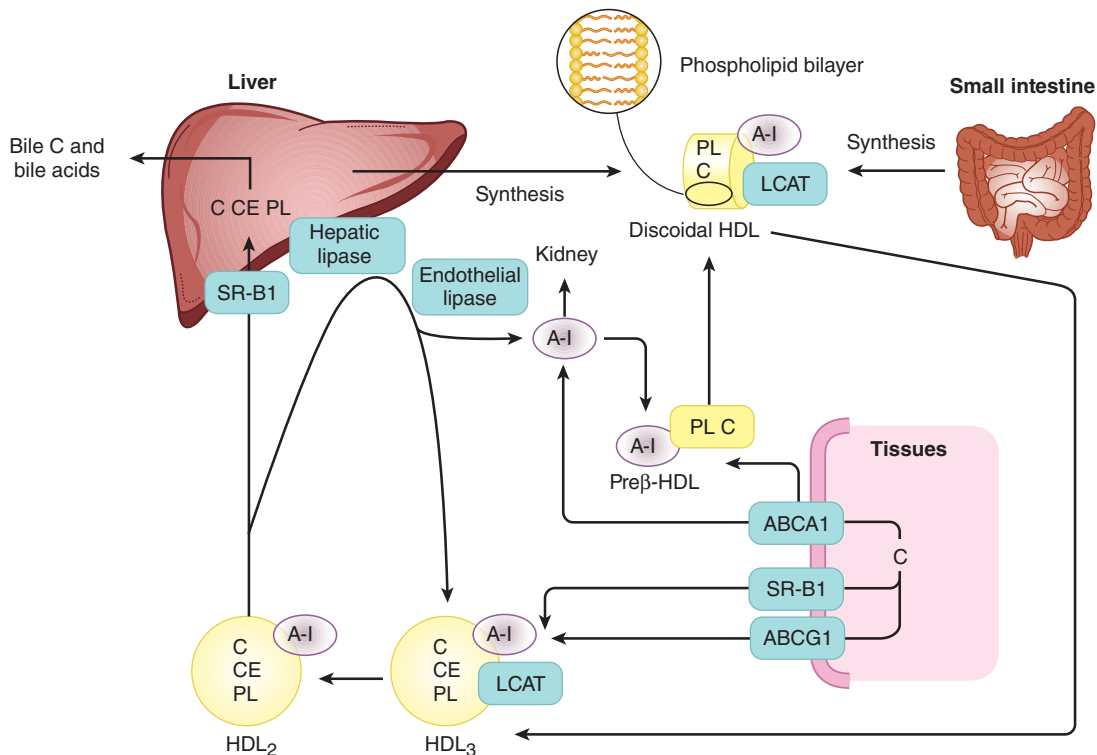

FIGURE 25–5 Metabolism of high-density lipoprotein (HDL) in reverse cholesterol transport. (A-I, apolipoprotein A-I; ABCA 1, ATP-binding cassette transporter A1; ABCG1, ATP-binding cassette transporter G1; C, cholesterol; CE, cholesteryl ester; LCAT, lecithin:cholesterol acyltransferase; PL, phospholipid; SR-B1, scavenger receptor B1.) Pre-β-HDL, HDL₂, HDL₃—see Table 25–1. Surplus surface constituents from the action of lipoprotein lipase on chylomicrons and VLDL are another source of pre-β-HDL. Hepatic lipase activity is increased by androgens and decreased by estrogens, which may account for higher concentrations of plasma HDL₂ in women.

to act as a repository for the apo C and apo E required in the metabolism of chylomicrons and VLDL. Nascent HDL consists of discoidal phospholipid bilayers containing apo A and free cholesterol. These lipoproteins are similar to the particles found in the plasma of patients with a deficiency of the plasma enzyme **lecithin:cholesterol acyltransferase (LCAT)** and in the plasma of patients with **obstructive jaundice**. LCAT—and the LCAT activator apo A-I—bind to the discoidal particles, and the surface phospholipid and free cholesterol are converted into cholesteryl esters and lysolecithin (see Chapter 24). The nonpolar cholesteryl esters move into the hydrophobic interior of the bilayer, whereas lysolecithin is transferred to plasma albumin. Thus, a nonpolar core is generated, forming a spherical, pseudomicellar HDL covered by a surface film of polar lipids and apolipoproteins. This aids the removal of excess unesterified cholesterol from lipoproteins and tissues as described below. The **class B scavenger receptor B1 (SR-B1)** has been identified as an **HDL receptor with a dual role in HDL metabolism**. In the liver and in steroidogenic tissues, it binds HDL via apo A-I, and cholesteryl ester is selectively delivered to the cells, although the particle itself, including apo A-I, is not taken up. In the tissues, on the other hand, SR-B1 mediates the acceptance of cholesterol effluxed from the cells by HDL, which then transports it to the liver for excretion via the bile (either as cholesterol or after conversion to bile acids) in the process known as **reverse cholesterol transport** (Figure 25–5). HDL₃, generated from discoidal HDL by the action of LCAT, accepts cholesterol from the tissues via the **SR-B1** and the cholesterol is then esterified by LCAT, increasing the size of the particles to form the less dense HDL₂. HDL₃ is then reformed, either after selective delivery of cholesteryl ester to the liver via the SR-B1 or by hydrolysis of HDL₂ phospholipid and triacylglycerol by hepatic lipase and endothelial lipase. This interchange of HDL₂ and HDL₃ is called the **HDL cycle** (Figure 25–5). Free apo A-I is released by these processes and forms **pre β -HDL** after associating with a minimum amount of phospholipid and cholesterol. Surplus apo A-I is destroyed in the kidney. A second important mechanism for reverse cholesterol transport involves the **ATP-binding cassette transporters A1 (ABCA1) and G1 (ABCG1)**. These transporters are members of a family of transporter proteins that couple the hydrolysis of ATP to the binding of a substrate, enabling it to be transported across the membrane. ABCG1 mediates the transport of cholesterol from cells to HDL, while ABCA1 preferentially promotes efflux to poorly lipidated particles such as pre β -HDL or apo A-I, which are then converted to HDL₃ via discoidal HDL (Figure 25–5). Pre β -HDL is the most potent form of HDL inducing cholesterol efflux from the tissues.

HDL concentrations vary reciprocally with plasma triacylglycerol concentrations and directly with the activity of lipoprotein lipase. This may be due to surplus surface constituents, eg, phospholipid and apo A-I, being released during hydrolysis of chylomicrons and VLDL and contributing toward the formation of pre β -HDL and discoidal HDL. HDL₂ concentrations are **inversely related to the incidence of atherosclerosis**, possibly because they reflect the efficiency of reverse cholesterol transport. HDL_c (HDL₁) is found in the blood of diet-induced

hypercholesterolemic animals. It is rich in cholesterol, and its sole apolipoprotein is apo E. It appears that all plasma lipoproteins are interrelated components of one or more metabolic cycles that together are responsible for the complex process of plasma lipid transport.

THE LIVER PLAYS A CENTRAL ROLE IN LIPID TRANSPORT & METABOLISM

The liver carries out the following major functions in lipid metabolism:

1. It facilitates the digestion and absorption of lipids by the production of **bile**, which contains cholesterol and bile salts synthesized within the liver de novo or after uptake of lipoprotein cholesterol (see Chapter 26).
2. It actively **synthesizes and oxidizes fatty acids** (see Chapters 22 and 23) and also synthesizes triacylglycerols and phospholipids (see Chapter 24).
3. It **converts fatty acids to ketone bodies (ketogenesis)** (see Chapter 22).
4. It plays an integral part in the **synthesis and metabolism of plasma lipoproteins** (this chapter).

Hepatic VLDL Secretion Is Related to Dietary & Hormonal Status

The cellular events involved in VLDL formation and secretion have been described above (Figure 25–2) and are shown in **Figure 25–6**. Hepatic VLDL assembly requires the synthesis of apoB100 and a source of triacylglycerol. ApoB100 is synthesized on polyribosomes and translocated to the lumen of the endoplasmic reticulum as it is formed. As the protein enters the lumen it is lipidated with phospholipid the aid of the **microsomal triglyceride transfer protein (MTP)**, which also facilitates the transfer of triacylglycerol across the ER membrane, and apoB-containing **VLDL2** (or precursor VLDL) particles are formed. The triacylglycerol (TG) is derived from lipolysis of cytosolic TG lipid droplets and reesterification in a pathway requiring phospholipid derivatives and diacylglycerol acyl transferases. TG not used for VLDL1 formation is recycled to the cytosolic droplets. After assembly in the ER, VLDL2 are carried in COPII vesicles (see Chapter 49) to the golgi, where they fuse with TG-rich lipid droplets to produce **VLDL1**. Phosphatidic acid produced by the action of phospholipase D when activated by a small GTP binding protein called **ADP-ribosylation factor-1 (ARF-1)** is needed for the formation of the TG-rich particles and/or VLDL2. Although some VLDL2 particles may be secreted without fusion, most particles which leave the cell are in the form of VLDL1. These nascent VLDL then acquire apolipoproteins C and E from HDL in the circulation to become mature VLDL.

Triacylglycerol for VLDL formation is synthesized from FFA. The fatty acids used are derived from two possible sources: (1) de novo synthesis within the liver from **acetyl-CoA** derived mainly from carbohydrate (perhaps not so

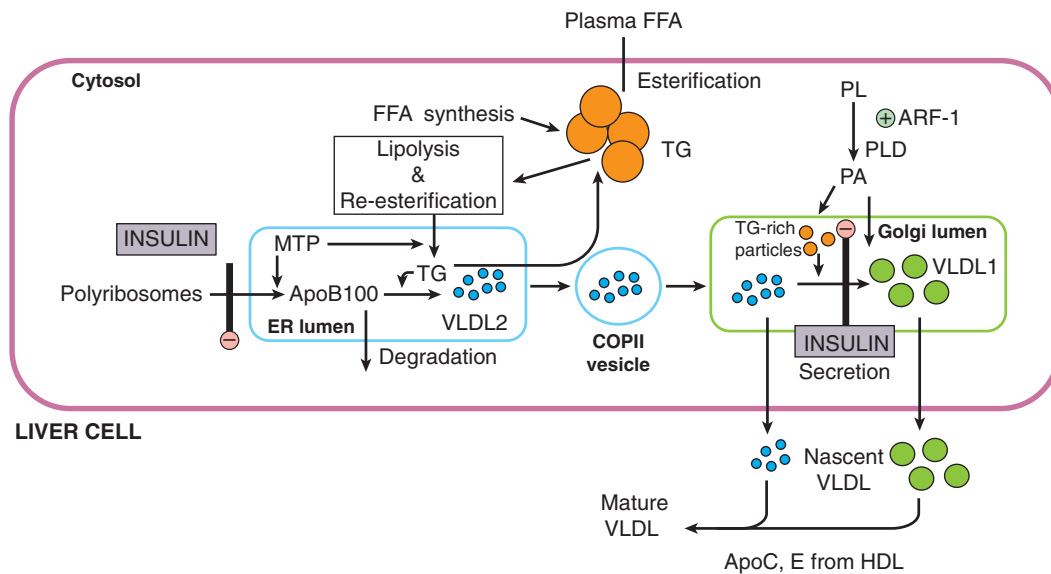

FIGURE 25-6 The assembly of very low density lipoprotein (VLDL) in the liver (Apo, apolipoprotein; ARF-1, ADP-ribosylation factor-1; FFA, free fatty acids; HDL, high-density lipoproteins; MTP, microsomal triacylglycerol transfer protein; PA, phosphatidic acid; PL, phospholipid; PLD, phospholipase D; TG, triacylglycerol.) The pathways indicated form a basis for events depicted in Figure 25-2. Apo B-100 is synthesized on polyribosomes and is lipidated with PL by MTP as it enters the ER lumen. Any excess is degraded in proteasomes. TG derived from lipolysis of cytosolic lipid droplets followed by resynthesis is transferred into the ER lumen with the aid of MTP and interacts with apoB-100 forming VLDL2. Excess TG is recycled to the cytosolic lipid droplets. VLDL2 are translocated to the golgi in COPII vesicles where they fuse with TG-rich particles to form VLDL1. PA is produced by activation of PLD by ARF-1 and is incorporated into the TG-rich VLDL1 and/or VLDL2. Both VLDL1 and VLDL2 may be secreted into the blood. Insulin inhibits VLDL secretion by inhibiting apoB-100 synthesis and the formation of VLDL1 from VLDL2.

important in humans) and (2) uptake of FFA from the circulation. The first source is predominant in the well-fed condition, when fatty acid synthesis is high and the level of circulating FFAs is low. As triacylglycerol does not normally accumulate in the liver in these conditions, it must be inferred that it is transported from the liver in VLDL as rapidly as it is synthesized. FFAs from the circulation are the main source during starvation, the feeding of high-fat diets, or in diabetes mellitus, when hepatic lipogenesis is inhibited. Factors that enhance both the synthesis of triacylglycerol and the secretion of VLDL by the liver include (1) the fed state rather than the starved state; (2) the feeding of diets high in carbohydrate (particularly if they contain sucrose or fructose), leading to high rates of lipogenesis and esterification of fatty acids; (3) high levels of circulating FFA; (4) ingestion of ethanol; and (5) the presence of high concentrations of insulin and low concentrations of glucagon, which enhance fatty acid synthesis and esterification and inhibit their oxidation.

Insulin suppresses hepatic VLDL secretion both by inhibiting apo 100 synthesis and by inhibiting the conversion of the smaller VLDL2 into VLDL1 by fusion with bulk TG. Some other factors which are known to inhibit or prevent VLDL assembly in the liver include the antibiotic brefeldin A, which inhibits the action of ARF-1; the sulfonylurea hypoglycemic drug, tolbutamide, dietary ω 3 fatty acids (see Chapter 21), and orotic acid, an intermediate in the synthesis of pyrimidines

(Chapter 33) decrease the rate of TG lipolysis; and a defect in the MTP gene. Glucose, on the other hand, enhances VLDL production by promoting TG lipolysis. The regulation of VLDL formation in the liver is complex and involves interactions between hormonal and dietary factors that are not yet fully understood.

CLINICAL ASPECTS

Imbalance in the Rate of Triacylglycerol Formation & Export Causes Fatty Liver

For a variety of reasons, lipid—mainly as triacylglycerol—can accumulate in the liver (Figure 25-6). Extensive accumulation is regarded as a pathologic condition. **Nonalcoholic fatty liver disease (NAFLD)** is the most common liver disorder worldwide. When accumulation of lipid in the liver becomes chronic, inflammatory and fibrotic changes may develop leading to **nonalcoholic steatohepatitis (NASH)**, which can progress to liver diseases including **cirrhosis, hepatocarcinoma, and liver failure**.

Fatty livers fall into two main categories. The first type is associated with **raised levels of plasma free fatty acids** resulting from mobilization of fat from adipose tissue or from the hydrolysis of lipoprotein triacylglycerol by lipoprotein lipase in extrahepatic tissues. The production of VLDL does not

keep pace with the increasing influx and esterification of free fatty acids, allowing triacylglycerol to accumulate, which in turn causes a fatty liver. This occurs during **starvation** and the feeding of **high-fat diets**. The ability to secrete VLDL may also be impaired (eg, in starvation). In uncontrolled **diabetes mellitus**, **twin lamb disease**, and **ketosis in cattle**, fatty infiltration is sufficiently severe to cause visible pallor (fatty appearance) and enlargement of the liver with possible liver dysfunction.

The second type of fatty liver is usually due to a **metabolic block in the production of plasma lipoproteins**, thus allowing triacylglycerol to accumulate. Theoretically, the lesion may be due to (1) a block in apolipoprotein synthesis (or an increase in its degradation before it can be incorporated into VLDL), (2) a block in the synthesis of the lipoprotein from lipid and apolipoprotein, (3) a failure in provision of phospholipids that are found in lipoproteins, or (4) a failure in the secretory mechanism itself.

One type of fatty liver that has been studied extensively in rats is caused by a deficiency of **choline**, which has therefore been called a **lipotropic factor**. The antibiotic puromycin, ethionine (α -amino- γ -mercaptobutyric acid), carbon tetrachloride, chloroform, phosphorus, lead, and arsenic all cause fatty liver and a marked reduction in concentration of VLDL in rat blood. Choline will not protect the organism against these agents, but appears to aid in recovery. The action of carbon tetrachloride probably involves formation of free radicals causing lipid peroxidation. Some protection against this is provided by the antioxidant action of **vitamin E**-supplemented diets. The action of ethionine is thought to be caused by a reduction in availability of ATP due to its replacing methionine in S-adenosylmethionine, trapping available adenine and preventing synthesis of ATP. **Orotic acid** also causes fatty liver; it is believed to interfere with glycosylation of the lipoprotein, thus inhibiting release, and may also impair the recruitment of triacylglycerol to the particles. A deficiency of vitamin E enhances the hepatic necrosis of the choline deficiency type of fatty liver. Added vitamin E or a source of **selenium** has a protective effect by combating lipid peroxidation. In addition to protein deficiency, essential fatty acid and vitamin deficiencies (eg, linoleic acid, pyridoxine, and pantothenic acid) can cause fatty infiltration of the liver.

Ethanol Also Causes Fatty Liver

Alcoholic fatty liver is the first stage in **alcoholic liver disease (ALD)** which is caused by **alcoholism** and ultimately leads to **cirrhosis**. The fat accumulation in the liver is caused by a combination of impaired fatty acid oxidation and increased lipogenesis, which is thought to be due to changes in the $[\text{NADH}]/[\text{NAD}^+]$ redox potential in the liver, and also to interference with the action of transcription factors regulating the expression of the enzymes involved in the pathways. Oxidation of ethanol by **alcohol dehydrogenase** leads to excess production of NADH, which competes with reducing equivalents from other substrates, including fatty acids, for the respiratory chain.

This inhibits their oxidation and causes increased esterification of fatty acids to form triacylglycerol, resulting in the fatty liver. Oxidation of ethanol leads to the formation of acetaldehyde, which is oxidized by **aldehyde dehydrogenase**, producing acetate. The increased $(\text{NADH})/(\text{NAD}^+)$ ratio also causes increased $(\text{lactate})/(\text{pyruvate})$, resulting in **hyperlactacidemia**, which decreases excretion of uric acid, aggravating **gout**.

Some metabolism of ethanol takes place via a cytochrome P450-dependent microsomal ethanol oxidizing system (MEOS) involving NADPH and O_2 . This system increases in activity in **chronic alcoholism** and may account for the increased metabolic clearance in this condition. Ethanol also inhibits the metabolism of some drugs, eg, barbiturates, by competing for cytochrome P450-dependent enzymes.

In some Asian populations and Native Americans, alcohol consumption results in increased adverse reactions to acetaldehyde owing to a genetic defect of mitochondrial aldehyde dehydrogenase.

ADIPOSE TISSUE IS THE MAIN STORE OF TRIACYLGLYCEROL IN THE BODY

Triacylglycerols are stored in adipose tissue in large lipid droplets and are continually undergoing lipolysis (hydrolysis) and reesterification. These two processes are entirely different pathways involving different reactants and enzymes. This allows the processes of esterification or lipolysis to be regulated separately by many nutritional, metabolic, and hormonal factors. The balance between these two processes determines the magnitude of the FFA pool in adipose tissue, which in turn determines the level of FFA circulating in the plasma. Since the latter has most profound effects upon the metabolism of other tissues, particularly liver and muscle, the factors operating in adipose tissue that regulate the outflow of FFA exert an influence far beyond the tissue itself. Moreover, since the discovery in the last 20 years that adipose tissue secretes hormones such as leptin and adiponectin, known as adipokines, its role as an endocrine organ has been recognized. Leptin, regulates energy homeostasis by stimulating energy use and limiting food intake. If it is lacking, food intake may be uncontrolled, causing obesity. Adiponectin modulates glucose and lipid metabolism in muscle and liver, and enhances the sensitivity of tissues to insulin.

The Provision of Glycerol 3-Phosphate Regulates Esterification: Lipolysis Is Controlled by Hormone-Sensitive Lipase

Triacylglycerol is synthesized from acyl-CoA and glycerol-3-phosphate (see Figure 24–2). Since the enzyme **glycerol kinase** is not expressed in adipose tissue, glycerol cannot be utilized for the provision of glycerol 3-phosphate, which must be supplied from glucose via glycolysis (**Figure 25-7**).

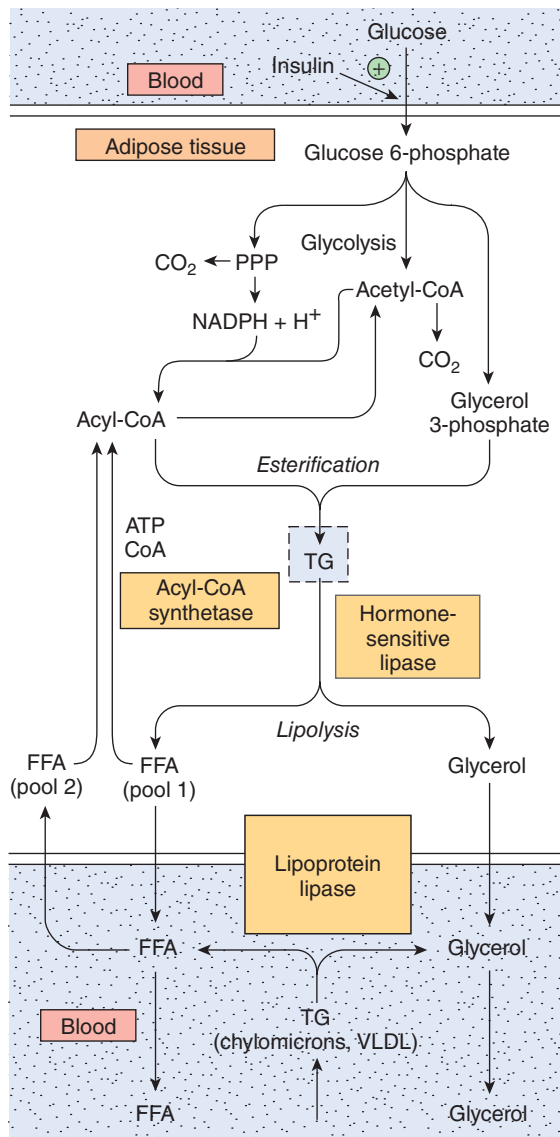

FIGURE 25-7 Triacylglycerol metabolism in adipose tissue.

Hormone-sensitive lipase is activated by ACTH, TSH, glucagon, epinephrine, norepinephrine, and vasopressin and inhibited by insulin, prostaglandin E₁, and nicotinic acid. Details of the formation of glycerol 3-phosphate from intermediates of glycolysis are shown in Figure 24-2. (FFA, free fatty acids; PPP, pentose phosphate pathway; TG, triacylglycerol; VLDL, very low density lipoprotein.)

Triacylglycerol undergoes hydrolysis by a **hormone-sensitive lipase** to form FFA and glycerol. This lipase is distinct from lipoprotein lipase, which catalyzes lipoprotein triacylglycerol hydrolysis before its uptake into extrahepatic tissues (see above). Since the glycerol cannot be utilized, it enters the blood and is taken up and transported to tissues such as the liver and kidney, which possess an active glycerol kinase. The FFA formed by lipolysis can be reconverted in adipose tissue to acyl-CoA by **acyl-CoA synthetase** and reesterified with glycerol-3-phosphate to form triacylglycerol. Thus, **there is a continuous cycle of lipolysis and reesterification within the tissue** (Figure 25-7). However, when the rate of reesterification is not sufficient to match the rate of lipolysis, FFA accumulate and diffuse into the

plasma, where they bind to albumin and raise the concentration of plasma-free fatty acids.

Increased Glucose Metabolism Reduces the Output of FFA

When the utilization of glucose by adipose tissue is increased, the FFA outflow decreases. However, the release of glycerol continues, demonstrating that the effect of glucose is not mediated by reducing the rate of lipolysis. The effect is due to the provision of glycerol-3-phosphate, which enhances esterification of FFA. Glucose can take several pathways in adipose tissue, including oxidation to CO₂ via the citric acid cycle, oxidation in the pentose phosphate pathway, conversion to long-chain fatty acids, and formation of acylglycerol via glycerol 3-phosphate (Figure 25-7). When glucose utilization is high, a larger proportion of the uptake is oxidized to CO₂ and converted to fatty acids. However, as total glucose utilization decreases, the greater proportion of the glucose is directed to the formation of glycerol 3-phosphate for the esterification of acylCoA, which helps to minimize the efflux of FFA.

HORMONES REGULATE FAT MOBILIZATION

Adipose Tissue Lipolysis Is Inhibited by Insulin

The rate of release of FFA from adipose tissue is affected by many hormones that influence either the rate of esterification or the rate of lipolysis. **Insulin** inhibits the release of FFA from adipose tissue, which is followed by a fall in circulating plasma free fatty acids. Insulin also enhances lipogenesis and the synthesis of acylglycerol and increases the oxidation of glucose to CO₂ via the pentose phosphate pathway. All of these effects are dependent on the presence of glucose and can be explained, to a large extent, on the basis of the ability of insulin to enhance the uptake of glucose into adipose cells via the **GLUT 4 transporter**. In addition, insulin increases the activity of the enzymes pyruvate dehydrogenase, acetyl-CoA carboxylase, and glycerol phosphate acyltransferase, reinforcing the effects of increased glucose uptake on the enhancement of fatty acid and acylglycerol synthesis. These three enzymes (see Chapters 17, 23, 24) are regulated in a coordinate manner by phosphorylation-dephosphorylation mechanisms.

Another principal action of insulin in adipose tissue is to inhibit the activity of **hormone-sensitive lipase**, reducing the release not only of FFA but also of glycerol. Adipose tissue is much more sensitive to insulin than many other tissues, which points to adipose tissue as a major site of insulin action in vivo.

Several Hormones Promote Lipolysis

Other hormones accelerate the release of FFA from adipose tissue and raise the plasma-free fatty acid concentration by increasing the rate of lipolysis of the triacylglycerol stores (Figure 25-8). These include **epinephrine**, **norepinephrine**,

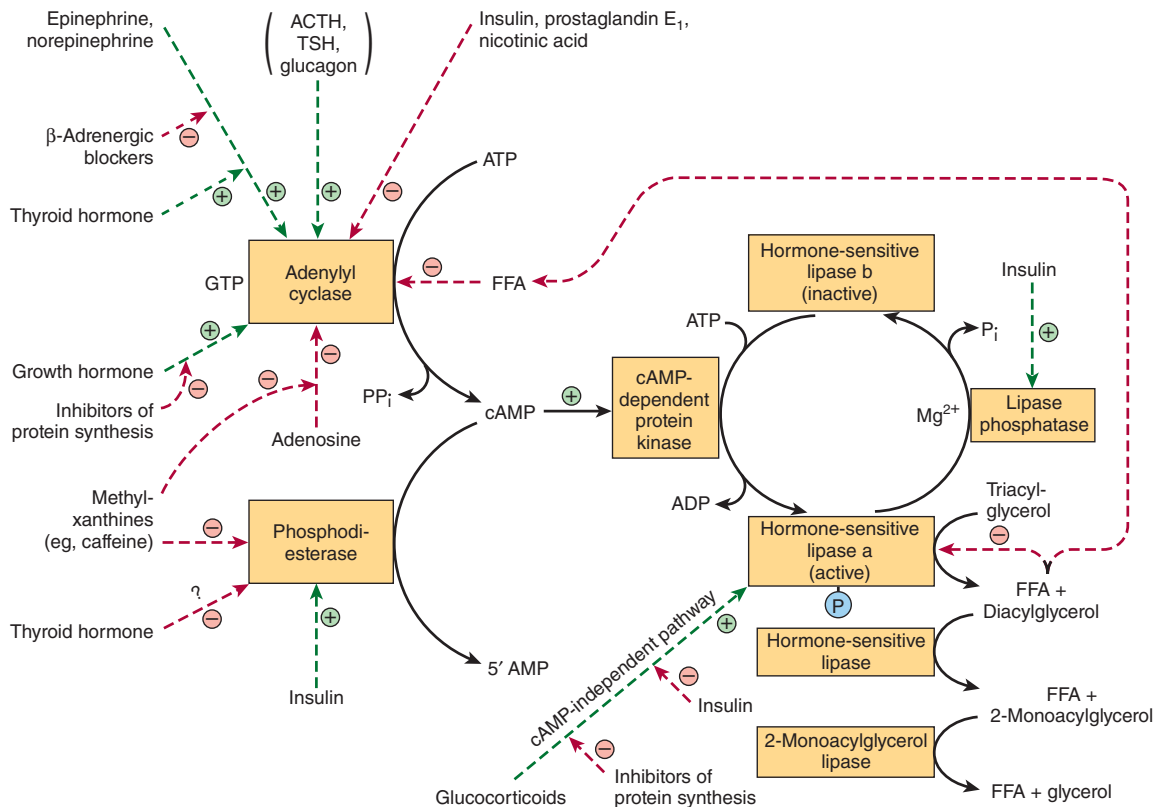

FIGURE 25-8 Control of adipose tissue lipolysis. (FFA, free fatty acids; TSH, thyroid-stimulating hormone.) Note the cascade sequence of reactions affording amplification at each step. The lipolytic stimulus is “switched off” by removal of the stimulating hormone; the action of lipase phosphatase; the inhibition of the lipase and adenylyl cyclase by high concentrations of FFA; the inhibition of adenylyl cyclase by adenosine; and the removal of cAMP by the action of phosphodiesterase. ACTH, TSH, and glucagon may not activate adenylyl cyclase *in vivo* since the concentration of each hormone required *in vitro* is much higher than is found in the circulation. Positive (⊕) and negative (⊖) regulatory effects are represented by broken lines and substrate flow by solid lines.

glucagon, adrenocorticotrophic hormone (ACTH), α - and β -melanocyte-stimulating hormones (MSH), thyroid-stimulating hormone (TSH), growth hormone (GH), and vasopressin. Many of these activate hormone-sensitive lipase. For an optimal effect, most of these lipolytic processes require the presence of **glucocorticoids** and **thyroid hormones**. These hormones act in a **facilitatory** or **permissive** capacity with respect to other lipolytic endocrine factors.

The hormones that act rapidly in promoting lipolysis, i.e., catecholamines (epinephrine and nor-epinephrine), do so by stimulating the activity of **adenylyl cyclase**, the enzyme that converts ATP to cAMP. The mechanism is analogous to that responsible for hormonal stimulation of glycogenolysis (Chapter 18). cAMP, by stimulating **cAMP-dependent protein kinase**, activates hormone-sensitive lipase. Thus, processes which destroy or preserve cAMP influence lipolysis. cAMP is degraded to 5'-AMP by the enzyme **cyclic 3',5'-nucleotide phosphodiesterase**. This enzyme is inhibited by methylxanthines such as **caffeine** and **theophylline**. **Insulin** antagonizes the effect of the lipolytic hormones. Lipolysis appears to be more sensitive to changes in concentration of insulin than are glucose utilization and esterification. The antilipolytic effects of insulin, nicotinic acid, and prostaglandin E_1 are accounted

for by inhibition of the synthesis of cAMP at the adenylyl cyclase site, acting through a G_i protein. Insulin also stimulates phosphodiesterase and the lipase phosphatase that inactivates hormone-sensitive lipase. The effect of growth hormone in promoting lipolysis is dependent on synthesis of proteins involved in the formation of cAMP. Glucocorticoids promote lipolysis via synthesis of new lipase protein by a cAMP-independent pathway, which may be inhibited by insulin, and also by promoting transcription of genes involved in the cAMP signal cascade. These findings help to explain the role of the pituitary gland and the adrenal cortex in enhancing fat mobilization. The sympathetic nervous system, through liberation of norepinephrine in adipose tissue, plays a central role in the mobilization of FFA. Thus, the increased lipolysis caused by many of the factors described above can be reduced or abolished by denervation of adipose tissue or by ganglionic blockade.

Perilipin Regulates the Balance Between Triacylglycerol Storage and Lipolysis in Adipocytes

Perilipin, a protein involved in the formation of lipid droplets in adipocytes, inhibits lipolysis in basal conditions by

preventing access of the lipase enzymes to the stored triacylglycerols. On stimulation with hormones which promote triacylglycerol degradation, however, the protein becomes phosphorylated and changes its conformation, exposing the lipid droplet surface to hormone-sensitive lipase and thus promoting lipolysis. Perilipin, therefore, enables the storage and breakdown of triacylglycerol to be coordinated according to the metabolic needs of the body.

Human Adipose Tissue May Not Be an Important Site of Lipogenesis

In adipose tissue, there is no significant incorporation of glucose or pyruvate into long-chain fatty acids, ATP-citrate lyase, a key enzyme in lipogenesis, does not appear to be present, and other lipogenic enzymes—for example, glucose-6-phosphate dehydrogenase and the malic enzyme—do not undergo adaptive changes. Indeed, it has been suggested that in humans there is a “**carbohydrate excess syndrome**” due to a unique limitation in ability to dispose of excess carbohydrate by lipogenesis. In birds, lipogenesis is confined to the liver, where it is particularly important in providing lipids for egg formation, stimulated by estrogens.

BROWN ADIPOSE TISSUE PROMOTES THERMOGENESIS

Brown adipose tissue is involved in metabolism, particularly at times when heat generation is necessary. Thus, the tissue is extremely active in some species, for example, during arousal from hibernation, in animals exposed to cold (nonshivering thermogenesis), and in heat production in the newborn. Though not a prominent tissue in humans, it is present in normal individuals, where it could be responsible for “**diet-induced thermogenesis.**” It is noteworthy that brown adipose tissue is reduced or absent in obese persons. The tissue is characterized by a well-developed blood supply and a high content of mitochondria and cytochromes, but low activity of ATP synthase. Metabolic emphasis is placed on oxidation of both glucose and fatty acids. **Norepinephrine** liberated from sympathetic nerve endings is important in increasing lipolysis in the tissue and increasing synthesis of lipoprotein lipase to enhance utilization of triacylglycerol-rich lipoproteins from the circulation. Oxidation and phosphorylation are not coupled in mitochondria of this tissue, and the phosphorylation that does occur is at the substrate level, eg, at the succinate thiokinase step and in glycolysis. Thus, **oxidation produces much heat, and little free energy is trapped in ATP.** A thermogenic uncoupling protein, **thermogenin**, acts as a proton conductance pathway dissipating the electrochemical potential across the mitochondrial membrane (Figure 25–9).

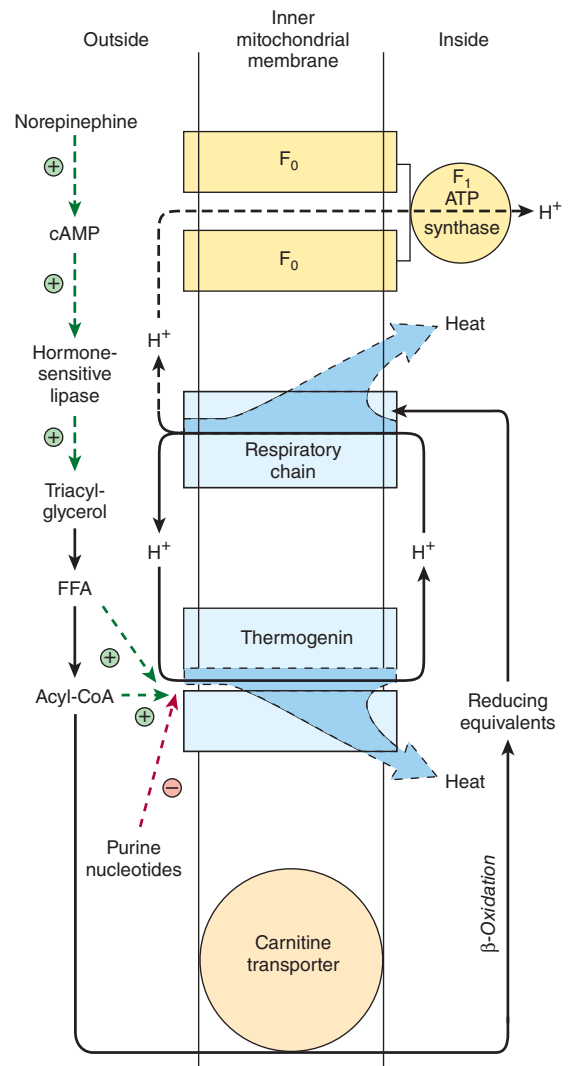

FIGURE 25–9 Thermogenesis in brown adipose tissue. Activity of the respiratory chain produces heat in addition to translocating protons (Chapter 13). These protons dissipate more heat when returned to the inner mitochondrial compartment via thermogenin instead of via the F₁ ATP synthase, the route that generates ATP (Figure 13–7). The passage of H⁺ via thermogenin is inhibited by purine nucleotides when brown adipose tissue is unstimulated. Under the influence of norepinephrine, the inhibition is removed by the production of free fatty acids (FFA) and acyl-CoA. Note the dual role of acyl-CoA in both facilitating the action of thermogenin and supplying reducing equivalents for the respiratory chain. ⊕ and ⊖ signify positive or negative regulatory effects.

SUMMARY

- Since nonpolar lipids are insoluble in water, for transport between the tissues in the aqueous blood plasma they are combined with amphipathic lipids and proteins to make water-miscible lipoproteins.
- Four major groups of lipoproteins are recognized. Chylomicrons transport lipids resulting from digestion and absorption. Very low density lipoproteins (VLDL) transport triacylglycerol from the liver. Low-density lipoproteins (LDL) deliver cholesterol to the tissues, and high-density lipoproteins

(HDL) remove cholesterol from the tissues and return it to the liver for excretion in the process known as reverse cholesterol transport.

- Chylomicrons and VLDL are metabolized by hydrolysis of their triacylglycerol, and lipoprotein remnants are left in the circulation. These are taken up by liver, but some of the remnants (IDL), resulting from VLDL form LDL, which is taken up by the liver and other tissues via the LDL receptor.
- Apolipoproteins constitute the protein moiety of lipoproteins. They act as enzyme activators (eg, apo C-II and apo A-I) or as ligands for cell receptors (eg, apo A-I, apo E, and apo B-100).
- Triacylglycerol is the main storage lipid in adipose tissue. Upon mobilization, FFA and glycerol are released. FFAs are an important fuel source.
- Brown adipose tissue is the site of “nonshivering thermogenesis.” It is found in hibernating and newborn animals and is present in small quantity in humans. Thermogenesis results from the presence of an uncoupling protein, thermogenin, in the inner mitochondrial membrane.

REFERENCES

- Arner P: Human fat cell lipolysis: biochemistry, regulation and clinical role. *Best Pract Res Clin Endocrinol Metab* 2005;19:471.
- Brasaemle DL: Thematic review series: adipocyte biology. The perilipin family of structural lipid droplet proteins: stabilization of lipid droplets and control of lipolysis. *J Lipid Res* 2007;48:2547.
- Fielding CJ, Fielding PE: Dynamics of lipoprotein transport in the circulatory system. In *Biochemistry of Lipids, Lipoproteins and Membranes*, 5th ed. Vance DE, Vance JE (editors). Elsevier, 2008;533–554.
- Galic S, Oakhill JS, Steinberg GR: Adipose tissue as an endocrine organ. *Mol Cell Endocrinol* 2010;316:129.
- Goldberg IJ, Merkel M: Lipoprotein lipase: physiology, biochemistry and molecular biology. *Front Biosci* 2001;6:D388.
- Lass A, Zimmermann R, Oberer M, et al: Lipolysis—a highly regulated multi-enzyme complex mediates the catabolism of cellular fat stores. *Prog Lipid Res* 2011;50:14.
- Lenz A, Diamond FB: Obesity: the hormonal milieu. *Curr Opin Endocrinol Diabetes Obes* 2008;15:9.
- Redgrave TG: Chylomicron metabolism. *Biochem Soc Trans* 2004;32:79.
- Schreuder TC, Verwer BJ, van Nieuwkerk CM, et al: Nonalcoholic fatty liver disease: an overview of current insights in pathogenesis, diagnosis and treatment. *World J Gastroenterol* 2008;14:2474.
- Schulz TJ, Tseng YH: Brown adipose tissue, development, metabolism and beyond. *Biochem J* 2013;453:167.
- Vance JE, Adeli K: Assembly and secretion of triacylglycerol-rich lipoproteins. In *Biochemistry of Lipids, Lipoproteins and Membranes*, 5th ed. Vance DE, Vance JE (editors). Elsevier, 2008;507–532.

Cholesterol Synthesis, Transport, & Excretion

Kathleen M. Botham, PhD, DSc & Peter A. Mayes, PhD, DSc

OBJECTIVES

*After studying this chapter,
you should be able to:*

- Appreciate the importance of cholesterol as an essential structural component of cell membranes and as a precursor of all other steroids in the body, and indicate its pathological role in cholesterol gallstone disease and atherosclerosis development.
- Identify the five stages in the biosynthesis of cholesterol from acetyl-CoA.
- Understand the role of 3-hydroxy-3-methylglutaryl CoA reductase (HMG-CoA reductase) in controlling the rate of cholesterol synthesis and explain the mechanisms by which its activity is regulated.
- Appreciate that cholesterol balance in cells is tightly regulated and indicate the factors involved in maintaining the correct balance.
- Explain the role of plasma lipoproteins, including chylomicrons, very low density lipoprotein (VLDL), low-density lipoprotein (LDL), and high-density lipoprotein (HDL), in the transport of cholesterol between tissues in the plasma.
- Name the two main primary bile acids found in mammals, outline the pathways by which they are synthesized from cholesterol in the liver, and understand the role of cholesterol 7 α -hydroxylase in regulating the process.
- Appreciate the importance of bile acid synthesis not only in the digestion and absorption of fats but also as a major excretory route for cholesterol.
- Indicate how secondary bile acids are produced from primary bile acids by intestinal bacteria.
- Explain what is meant by the “enterohepatic circulation” and why it is important.
- Identify the lifestyle factors that influence plasma cholesterol concentrations and thus affect the risk of coronary heart disease.
- Understand that the class of lipoprotein in which cholesterol is carried is important in determining the effects of plasma cholesterol on atherosclerosis development, with high levels of VLDL or LDL being deleterious and high levels of HDL being beneficial.
- Give examples of inherited and noninherited conditions affecting lipoprotein metabolism that cause hypo- or hyperlipoproteinemia.

BIOMEDICAL IMPORTANCE

Cholesterol is present in tissues and in plasma either as free cholesterol or combined with a long-chain fatty acid as cholesteryl ester, the storage form. In plasma, both forms are transported in lipoproteins (see Chapter 25). Cholesterol is an amphipathic lipid and as such is an essential structural component of membranes, where it is important for the maintenance of the correct permeability and fluidity, and of the outer layer of plasma lipoproteins. It is synthesized in many tissues from acetyl-CoA and is the precursor of all other steroids in the body, including **corticosteroids**, **sex hormones**, **bile acids**, and **vitamin D**. As a typical product of animal metabolism, cholesterol occurs in foods of animal origin such as egg yolk, meat, liver, and brain. Plasma **low-density lipoprotein (LDL)** is the vehicle that supplies cholesterol and cholesteryl ester to many tissues. Free cholesterol is removed from tissues by plasma **high-density lipoprotein (HDL)** and transported to the liver, where it is eliminated from the body either unchanged or after conversion to bile acids in the process known as **reverse cholesterol transport** (see Chapter 25). Cholesterol is a major constituent of **gallstones**. However, its chief role in pathologic processes is as a factor in the genesis of **atherosclerosis** of vital arteries, causing cerebrovascular, coronary, and peripheral vascular disease.

CHOLESTEROL IS BIOSYNTHESIZED FROM ACETYL-CoA

A little more than half the cholesterol of the body arises by synthesis (about 700 mg/d), and the remainder is provided by the average diet. The liver and intestine account for approximately 10% each of total synthesis in humans. Virtually all tissues containing nucleated cells are capable of cholesterol synthesis, which occurs in the endoplasmic reticulum and the cytosolic compartments.

Acetyl-CoA Is the Source of All Carbon Atoms in Cholesterol

Cholesterol is a 27-carbon compound consisting of 4 rings and a side chain (see Figure 21–20). It is synthesized from acetyl-CoA by a lengthy pathway that may be divided into five steps: (1) synthesis of **mevalonate** from acetyl-CoA (Figure 26–1); (2) formation of **isoprenoid units** from mevalonate by loss of CO₂ (Figure 26–2); (3) condensation of six isoprenoid units form **squalene** (Figure 26–2); (4) cyclization of squalene give rise to the parent steroid, **lanosterol**; (5) formation of cholesterol from lanosterol (Figure 26–3).

Step 1—Biosynthesis of Mevalonate: HMG-CoA (3-hydroxy-3-methylglutaryl-CoA) is formed by the reactions used in mitochondria to synthesize ketone bodies (see Figure 22–7). However, since cholesterol synthesis is extramitochondrial, the two pathways are distinct. Initially, two molecules of acetyl-CoA

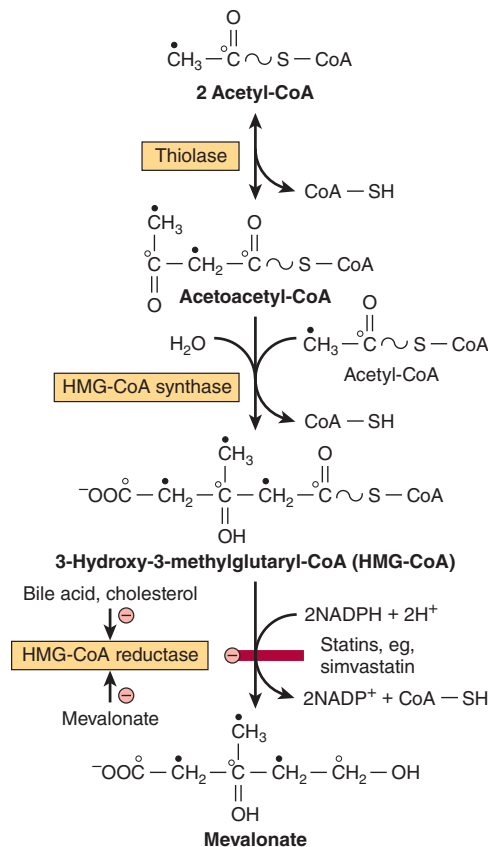

FIGURE 26–1 Biosynthesis of mevalonate. HMG-CoA reductase is inhibited by statins. The open and solid circles indicate the fate of each of the carbons in the acetyl moiety of acetyl-CoA.

condense to form acetoacetyl-CoA catalyzed by cytosolic **thiolase**. Acetoacetyl-CoA condenses with a further molecule of acetyl-CoA catalyzed by **HMG-CoA synthase** to form HMG-CoA, which is reduced to **mevalonate** by NADPH in a reaction catalyzed by **HMG-CoA reductase**. This last step is the principal regulatory step in the pathway of cholesterol synthesis and is the site of action of the most effective class of cholesterol-lowering drugs, the statins, which are HMG-CoA reductase inhibitors (Figure 26–1).

Step 2—Formation of Isoprenoid Units: Mevalonate is phosphorylated sequentially using ATP by three kinases, and after decarboxylation (Figure 26–2) the active isoprenoid unit, **isopentenyl diphosphate**, is formed.

Step 3—Six Isoprenoid Units Form Squalene: Isopentenyl diphosphate is isomerized by a shift of the double bond to form **dimethylallyl diphosphate**, and then condensed with another molecule of isopentenyl diphosphate to form the 10-carbon intermediate **geranyl diphosphate** (Figure 26–2). A further condensation with isopentenyl diphosphate forms **farnesyl diphosphate**. Two molecules of farnesyl diphosphate condense at the diphosphate end to form **squalene**. Initially, inorganic pyrophosphate is eliminated, forming presqualene diphosphate, which is then reduced by NADPH with elimination of a further inorganic pyrophosphate molecule.

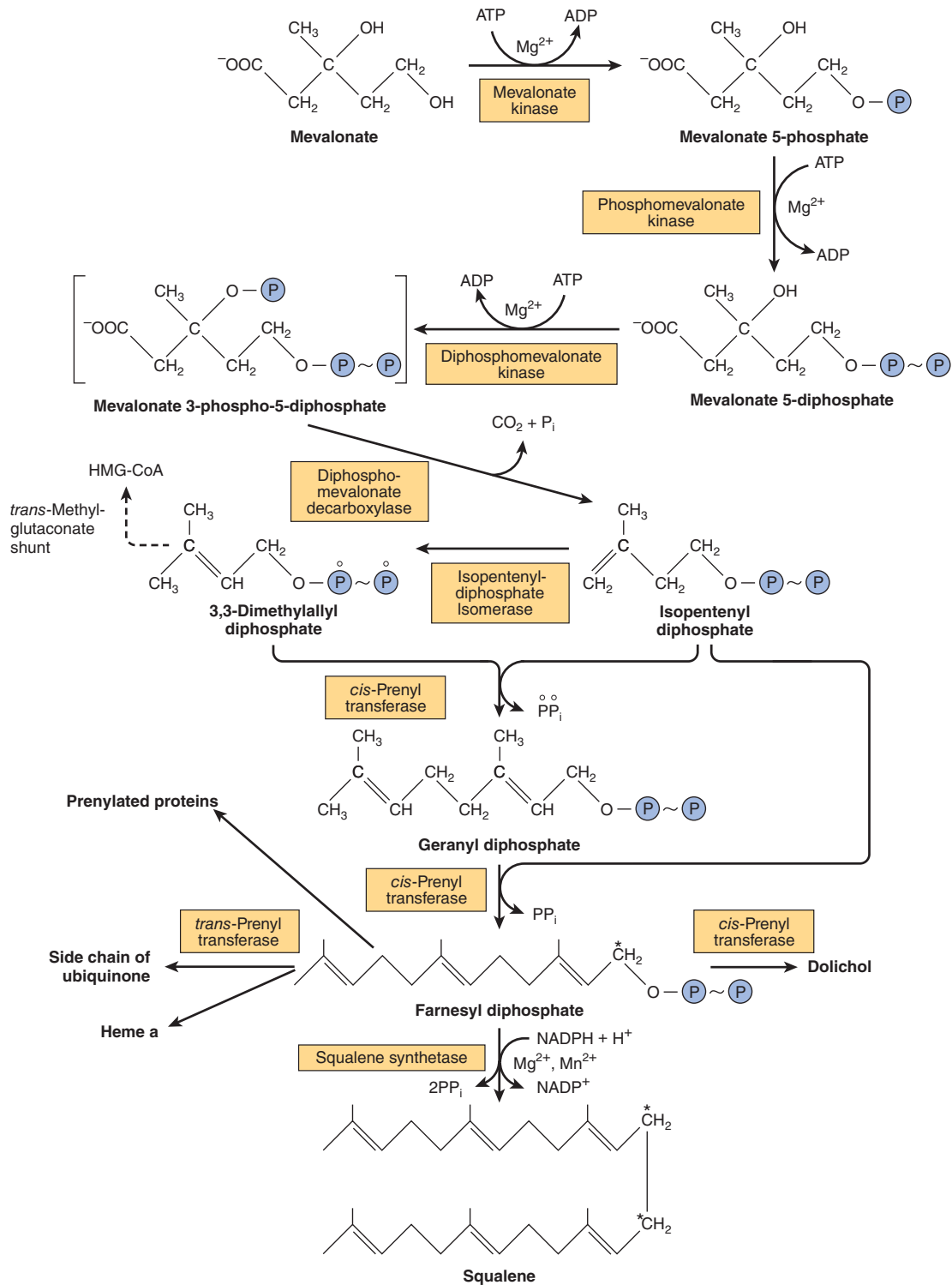

FIGURE 26-2 Biosynthesis of squalene, ubiquinone, dolichol, and other polyisoprene derivatives.

(HMG, 3-hydroxy-3-methylglutaryl) A farnesyl residue is present in heme a of cytochrome oxidase. The carbon marked with an asterisk becomes C₁₁ or C₁₂ in squalene. Squalene synthetase is a microsomal enzyme; all other enzymes indicated are soluble cytosolic proteins, and some are found in peroxisomes.

Step 4—Formation of Lanosterol: Squalene can fold into a structure that closely resembles the steroid nucleus (Figure 26-3). Before ring closure occurs, squalene is converted to squalene 2,3-epoxide by a mixed-function oxidase

in the endoplasmic reticulum, **squalene epoxidase**. The methyl group on C₁₄ is transferred to C₁₃ and that on C₈ to C₁₄ as cyclization occurs, catalyzed by **oxidosqualene-lanosterol cyclase**.

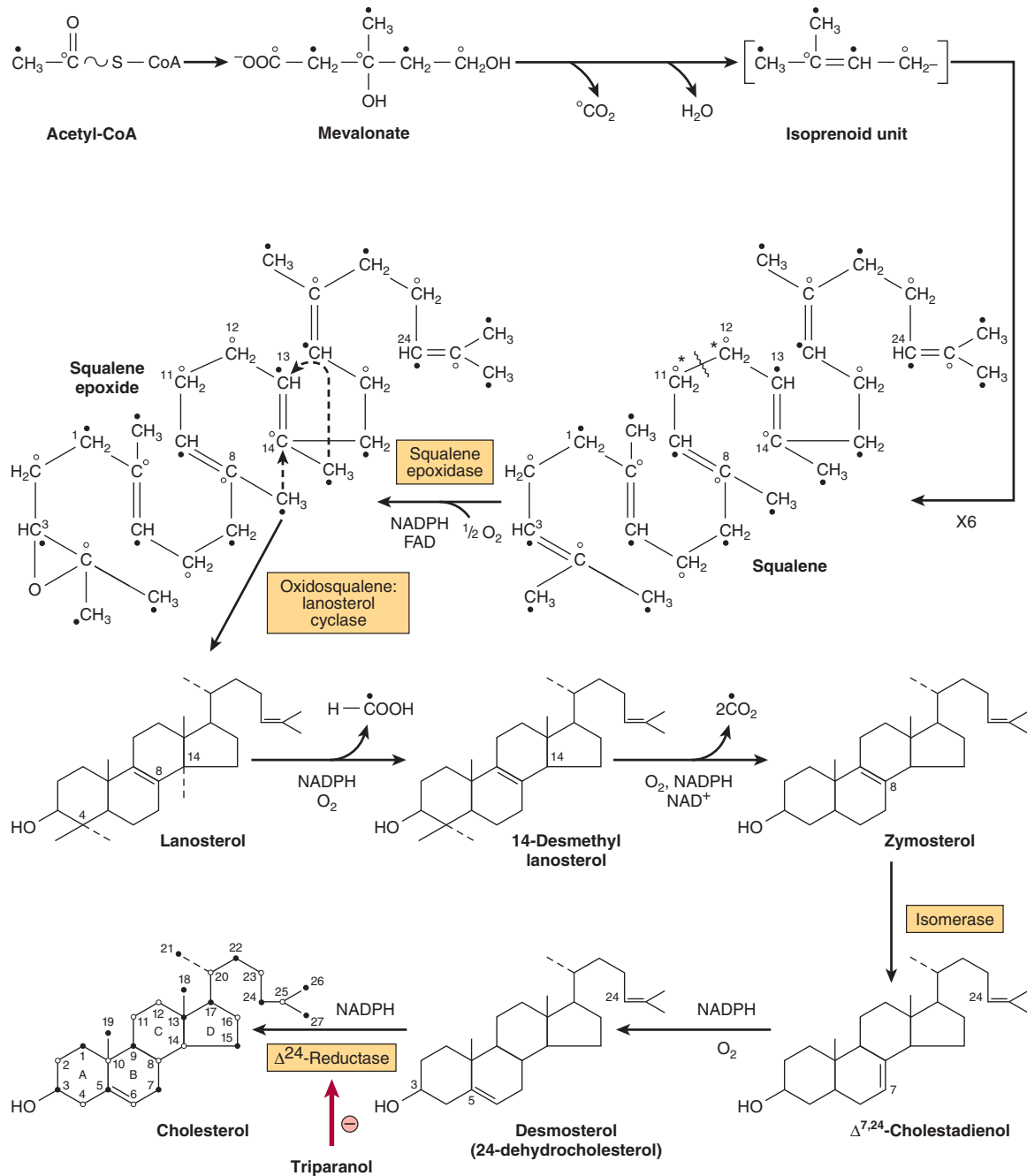

FIGURE 26-3 Biosynthesis of cholesterol. The numbered positions are those of the steroid nucleus and the open and solid circles indicate the fate of each of the carbons in the acetyl moiety of acetyl-CoA. (*Refer to labeling of squalene in Figure 26-2.)

Step 5—Formation of Cholesterol: The formation of cholesterol from **lanosterol** takes place in the membranes of the endoplasmic reticulum and involves changes in the steroid nucleus and the side chain (Figure 26-3). The methyl groups on C_{14} and C_4 are removed to form 14-desmethyl lanosterol and then zymosterol. The double bond at C_8 — C_9 is subsequently moved to C_5 — C_6 in two steps, forming **desmosterol**. Finally, the double bond of the side chain is reduced, producing cholesterol.

Farnesyl Diphosphate Gives Rise to Dolichol & Ubiquinone

The polyisoprenoids **dolichol** (see Figure 21-23 and Chapter 46) and **ubiquinone** (see Figure 13-6) are formed from farnesyl diphosphate by the further addition of up to 16 (dolichol) or 3-7 (ubiquinone) isopentenyl diphosphate residues (Figure 26-2). Some **GTP-binding proteins** in the cell membrane are prenylated with farnesyl or geranylgeranyl (20 carbon) residues.

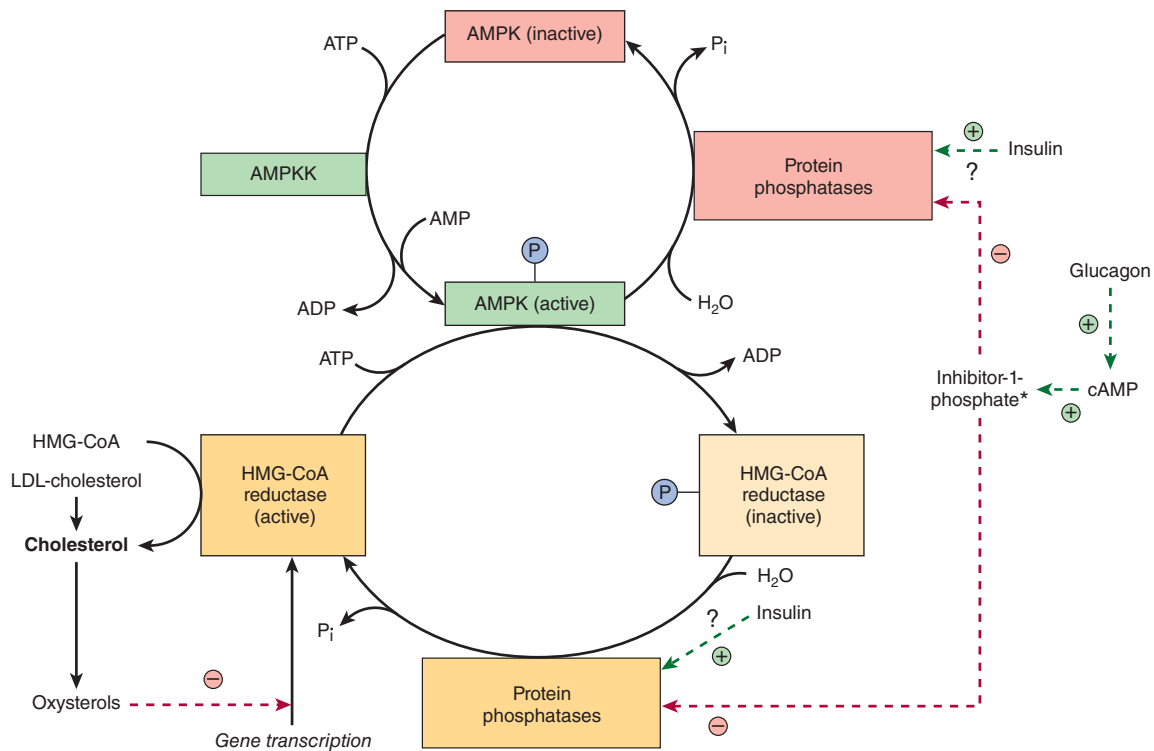

FIGURE 26-4 Possible mechanisms in the regulation of cholesterol synthesis by HMG-CoA reductase.

Insulin has a dominant role compared with glucagon. (AMPK, AMP activated protein kinase; AMPKK, AMP activated protein kinase kinase.) *See Figure 18-6.

Protein prenylation is believed to facilitate the anchoring of proteins into lipid membranes and may also be involved in protein-protein interactions and membrane-associated protein trafficking.

CHOLESTEROL SYNTHESIS IS CONTROLLED BY REGULATION OF HMG-CoA REDUCTASE

Regulation of cholesterol synthesis is exerted near the beginning of the pathway, at the HMG-CoA reductase step. The decreased synthesis of cholesterol in starving animals is accompanied by reduced activity of the enzyme. However, it is only hepatic synthesis that is inhibited by dietary cholesterol. HMG-CoA reductase in liver is inhibited by mevalonate, the immediate product of the reaction, and by cholesterol, the main product of the pathway. Cholesterol and metabolites repress transcription of the HMG-CoA reductase via activation of a **sterol regulatory element-binding protein (SREBP)** transcription factor. SREBPs are a family of proteins that regulate the transcription of a range of genes involved in the cellular uptake and metabolism of cholesterol and other lipids. SREBP activation is inhibited by **Insig** (insulin induced gene), a protein whose expression, as its name indicates, is induced by insulin and is present in the endoplasmic reticulum. Insig also promotes degradation of HMG-CoA reductase. A **diurnal variation** occurs both in cholesterol synthesis and reductase activity. In addition to these mechanisms regulating the rate

of protein synthesis/degradation, the enzyme activity is also modulated more rapidly by posttranslational modification (**Figure 26-4**). **Insulin or thyroid hormone** increases HMG-CoA reductase activity, whereas **glucagon or glucocorticoids** decrease it. Activity is reversibly modified by phosphorylation-dephosphorylation mechanisms, some of which may be cAMP-dependent and therefore immediately responsive to glucagon. **AMP-activated protein kinase (AMPK)** (formerly called HM-CoA reductase kinase) phosphorylates and inactivates HMG-CoA reductase. AMPK is activated via phosphorylation by **AMPK kinase (AMPKK)** and allosteric modification by AMP. Attempts to lower plasma cholesterol in humans by reducing the amount of cholesterol in the diet produce variable results. Generally, a decrease of 100 mg in dietary cholesterol causes a decrease of approximately 0.13 mmol/L of serum.

MANY FACTORS INFLUENCE THE CHOLESTEROL BALANCE IN TISSUES

In tissues, cholesterol balance is regulated as follows (**Figure 26-5**): An increase in cell cholesterol is caused by uptake of cholesterol-containing lipoproteins by receptors, for example, the LDL receptor or the scavenger receptor, uptake of free cholesterol from cholesterol-rich lipoproteins to the cell membrane, cholesterol synthesis, and hydrolysis of cholesteryl esters by the enzyme **cholesteryl ester hydrolase**. A decrease is due

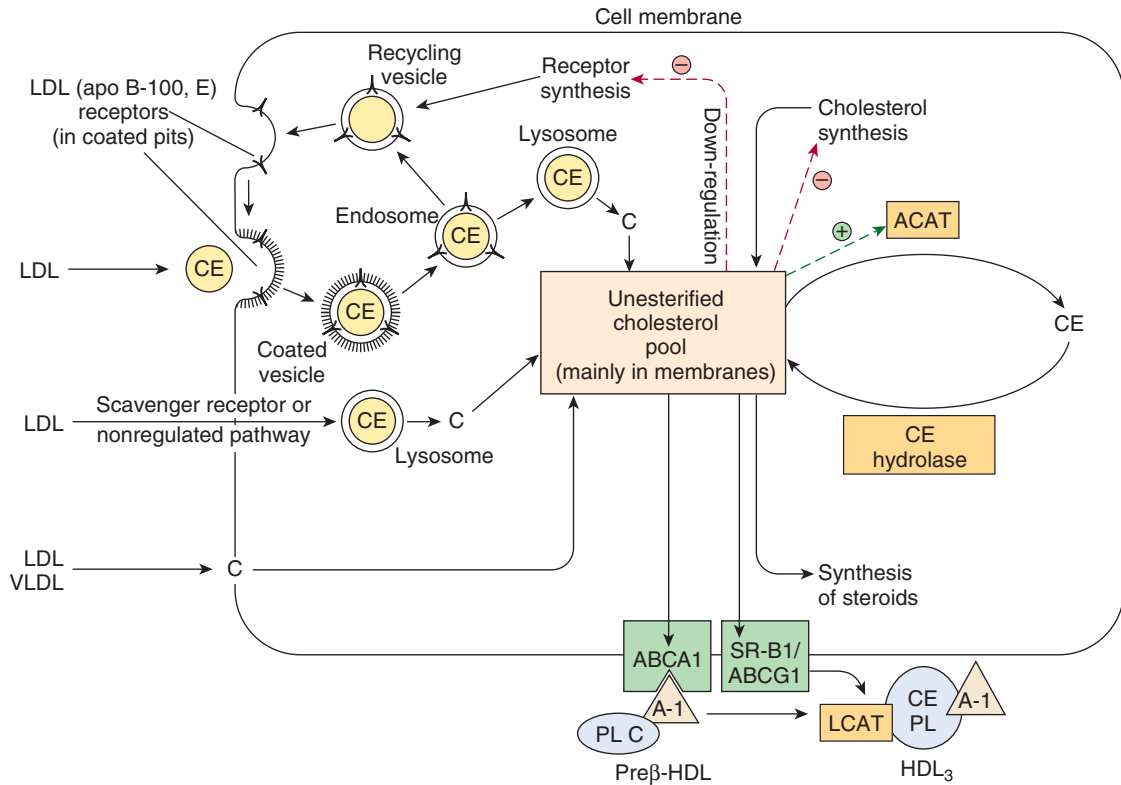

FIGURE 26-5 Factors affecting cholesterol balance at the cellular level. Reverse cholesterol transport may be mediated via the ABCA-1 transporter protein (with pre β -HDL as the exogenous acceptor) or the SR-B1 or ABCG-1 (with HDL₃ as the exogenous acceptor). (C, cholesterol; CE, cholesteryl ester; PL, phospholipid; ACAT, acyl-CoA:cholesterol acyltransferase; LCAT, lecithin:cholesterol acyltransferase; A-I, apolipoprotein A-I; LDL, low-density lipoprotein; VLDL, very low density lipoprotein.) LDL and HDL are not shown to scale.

to efflux of cholesterol from the membrane to HDL via the ABCA1, ABCG1, or SR-B1 (see Figure 25-5); esterification of cholesterol by ACAT (acyl-CoA:cholesterol acyltransferase); and utilization of cholesterol for synthesis of other steroids, such as hormones, or bile acids in the liver.

The LDL Receptor Is Highly Regulated

LDL (apo B-100, E) receptors occur on the cell surface in pits that are coated on the cytosolic side of the cell membrane with a protein called **clathrin**. The glycoprotein receptor spans the membrane, the B-100 binding region being at the exposed amino terminal end. After binding, LDL is taken up intact by **endocytosis**. The apoprotein and cholesteryl ester are then hydrolyzed in the lysosomes, and cholesterol is translocated into the cell. The receptors are recycled to the cell surface. This influx of cholesterol inhibits the transcription of the genes encoding HMG-CoA synthase, HMG-CoA reductase, and other enzymes involved in cholesterol synthesis, as well as the LDL receptor itself, via the SREBP pathway, and thus coordinately suppresses cholesterol synthesis and uptake. In addition, ACAT activity is stimulated, promoting cholesterol esterification. In addition, recent research has shown that the protein **proprotein convertase subtilisin/kexin type 9 (PCSK9)** regulates the recycling of the receptor to the cell

surface by targeting it for degradation. By these mechanisms, LDL receptor activity on the cell surface is regulated by the cholesterol requirement for membranes, steroid hormones, or bile acid synthesis, and the free cholesterol content of the cell is kept within relatively narrow limits (Figure 26-5).

CHOLESTEROL IS TRANSPORTED BETWEEN TISSUES IN PLASMA LIPOPROTEINS

Cholesterol is transported in plasma in lipoproteins, with the greater part in the form of cholesteryl ester (Figure 26-6), and in humans the highest proportion is found in LDL. Dietary cholesterol equilibrates with plasma cholesterol in days and with tissue cholesterol in weeks. Cholesteryl ester in the diet is hydrolyzed to cholesterol, which is then absorbed by the intestine together with dietary unesterified cholesterol and other lipids. With cholesterol synthesized in the intestines, it is then incorporated into chylomicrons (see Chapter 25). Of the cholesterol absorbed, 80% to 90% is esterified with long-chain fatty acids in the intestinal mucosa. Ninety-five percent of the chylomicron cholesterol is delivered to the liver in chylomicron remnants, and most of the cholesterol secreted by the liver in very low density lipoprotein (VLDL) is retained during

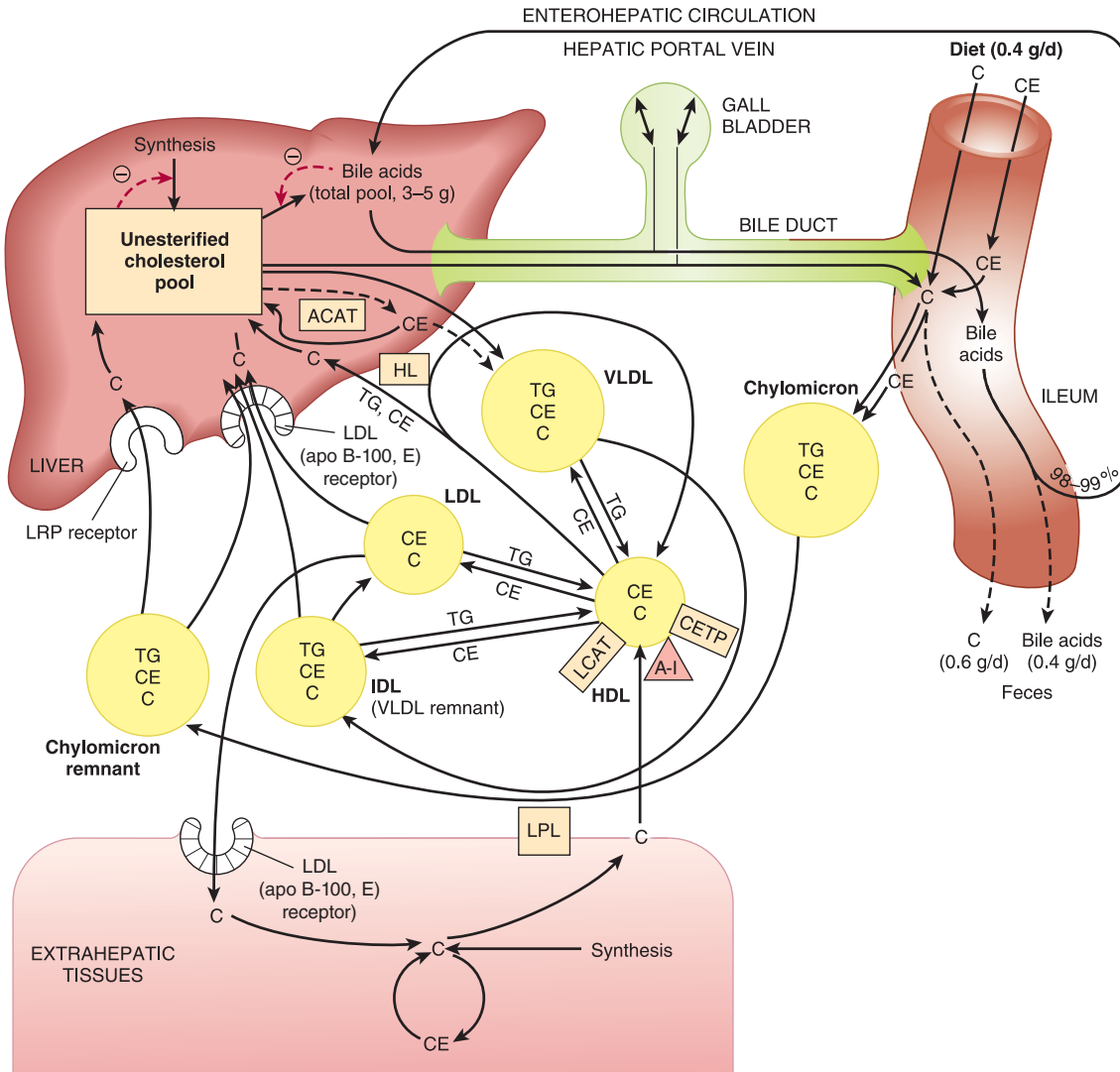

FIGURE 26–6 Transport of cholesterol between the tissues in humans. (ACAT, acyl-CoA:cholesterol acyltransferase; C, unesterified cholesterol; CE, cholesteryl ester; TG, triacylglycerol; VLDL, very low density lipoprotein; IDL, intermediate-density lipoprotein; LDL, low-density lipoprotein; HDL, high-density lipoprotein; LCAT, lecithin:cholesterol acyltransferase; A-I, apolipoprotein A-I; CETP, cholesteryl ester transfer protein; LPL, lipoprotein lipase; HL, hepatic lipase; LRP, LDL receptor-related protein-1.)

the formation of intermediate-density lipoprotein (IDL) and ultimately LDL, which is taken up by the LDL receptor in liver and extrahepatic tissues (see Chapter 25).

Plasma LCAT Is Responsible for Virtually All Plasma Cholesteryl Ester in Humans

Lecithin: cholesterol acyltransferase (LCAT) activity is associated with HDL containing apo A-I. As cholesterol in HDL becomes esterified, it creates a concentration gradient and draws in cholesterol from tissues and from other lipoproteins (Figures 26–5 and 26–6), thus enabling HDL to function in **reverse cholesterol transport** (see Figure 25–5).

Cholesteryl Ester Transfer Protein Facilitates Transfer of Cholesteryl Ester From HDL to Other Lipoproteins

Cholesteryl ester transfer protein, associated with HDL, is found in plasma of humans and many other species. It facilitates transfer of cholesteryl ester from HDL to VLDL, IDL, and LDL in exchange for triacylglycerol, relieving product inhibition of the LCAT activity in HDL. Thus, in humans, much of the cholesteryl ester formed by LCAT finds its way to the liver via VLDL remnants (IDL) or LDL (Figure 26–6). The triacylglycerol-enriched HDL₂ delivers its cholesterol to the liver in the HDL cycle (see Figure 25–5).

CHOLESTEROL IS EXCRETED FROM THE BODY IN THE BILE AS CHOLESTEROL OR BILE ACIDS (SALTS)

Cholesterol is excreted from the body via the bile either in the unesterified form or after conversion into bile acids in the liver. **Coprostanol** is the principal sterol in the feces; it is formed from cholesterol by the bacteria in the lower intestine.

Bile Acids Are Formed from Cholesterol

The **primary bile acids** are synthesized in the liver from cholesterol. These are **cholic acid** (found in the largest amount in most mammals) and **chenodeoxycholic acid** (Figure 26–7).

The 7α -hydroxylation of cholesterol is the first and principal regulatory step in the biosynthesis of bile acids and is catalyzed by **cholesterol 7α -hydroxylase**, a microsomal cytochrome P450 enzyme (see Chapter 12) designated **CYP7A1**. A typical monooxygenase, it requires oxygen, NADPH, and cytochrome P450. Subsequent hydroxylation steps are also catalyzed by monooxygenases. The pathway of bile acid biosynthesis divides early into one subpathway leading to **cholyl-CoA**, characterized by an extra α -OH group on position 12, and another pathway leading to **chenodeoxycholyl-CoA** (Figure 26–7). A second pathway in mitochondria involving the 27 -hydroxylation of cholesterol by the cytochrome P450 **sterol 27 -hydroxylase (CYP27A1)** as the first step is responsible for a significant proportion of the primary bile acids synthesized. The primary bile acids (Figure 26–7) enter the bile as glycine or taurine conjugates. Conjugation takes place in liver

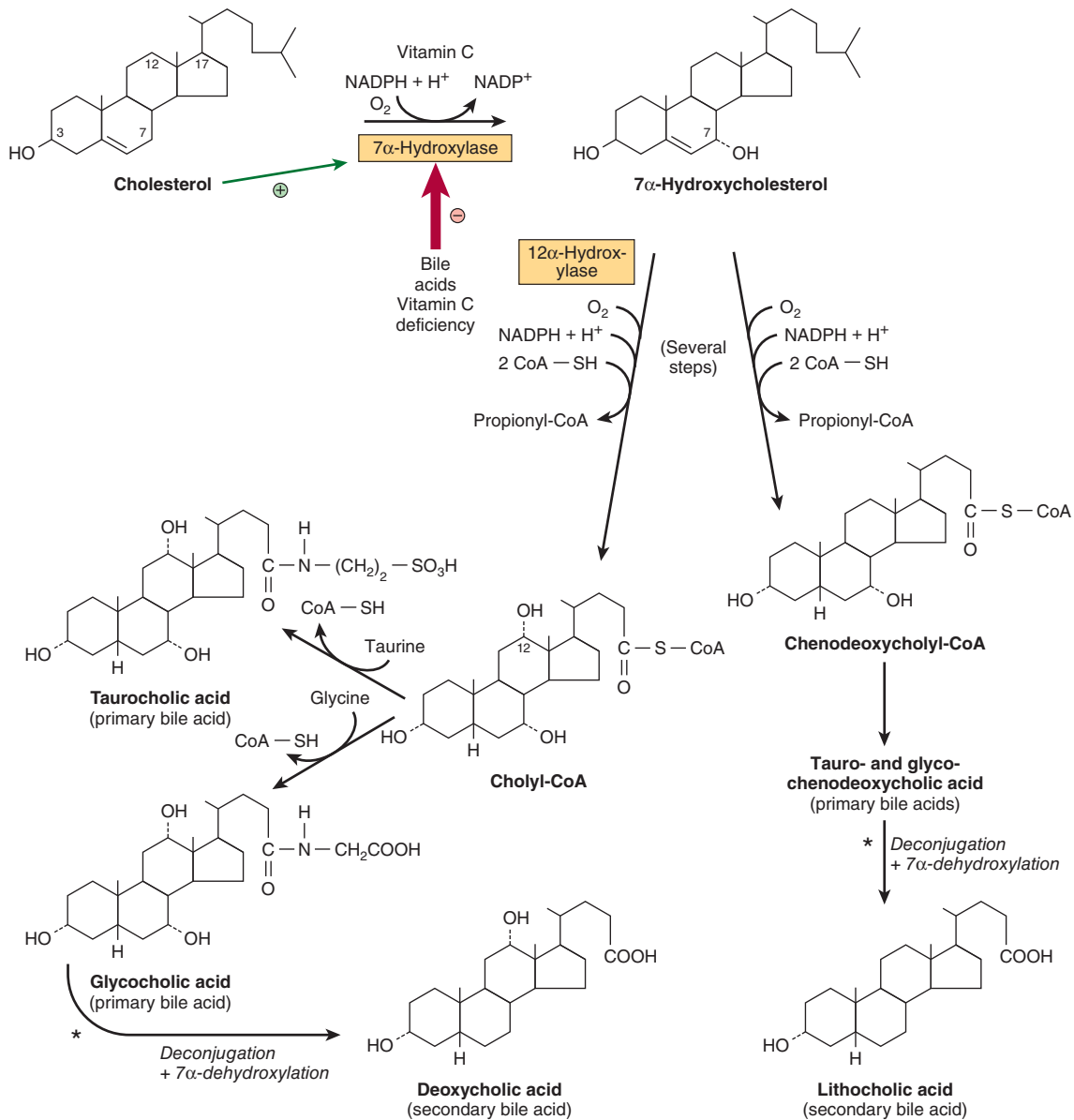

FIGURE 26–7 Biosynthesis and degradation of bile acids. A second pathway in mitochondria involves hydroxylation of cholesterol by sterol 27-hydroxylase. *Catalyzed by microbial enzymes.

peroxisomes. In humans, the ratio of the glycine to the taurine conjugates is normally 3:1. In the alkaline bile (pH 7.6–8.4), the bile acids and their conjugates are assumed to be in a salt form—hence the term “bile salts.”

Primary bile acids are further metabolized in the intestine by the activity of the intestinal bacteria. Thus, deconjugation and 7 α -dehydroxylation occur, producing the **secondary bile acids**, **deoxycholic acid**, and **lithocholic acid**.

Most Bile Acids Return to the Liver in the Enterohepatic Circulation

Although products of fat digestion, including cholesterol, are absorbed in the first 100 cm of small intestine, the primary and secondary bile acids are absorbed almost exclusively in the ileum, and 98% to 99% is returned to the liver via the portal circulation. This is known as the **enterohepatic circulation** (Figure 26–6). However, lithocholic acid, because of its insolubility, is not reabsorbed to any significant extent. Only a small fraction of the bile salts escapes absorption and is therefore eliminated in the feces. Nonetheless, this represents a major pathway for the elimination of cholesterol. Each day the pool of bile acids (about 3–5 g) is cycled through the intestine 6 to 10 times and an amount of bile acid equivalent to that lost in the feces is synthesized from cholesterol, so that a pool of bile acids of constant size is maintained. This is accomplished by a system of feedback controls.

Bile Acid Synthesis Is Regulated at the CYP7A1 Step

The principal rate-limiting step in the biosynthesis of bile acids is at the **CYP7A1 reaction** (Figure 26–7). The activity of the enzyme is feedback regulated via the nuclear bile acid-binding receptor, **farnesoid X receptor (FXR)**. When the size of the bile acid pool in the enterohepatic circulation increases, FXR is activated, and transcription of the CYP7A1 gene is suppressed. Chenodeoxycholic acid is particularly important in activating FXR. CYP7A1 activity is also enhanced by cholesterol of endogenous and dietary origin and regulated by insulin, glucagon, glucocorticoids, and thyroid hormone.

CLINICAL ASPECTS

Serum Cholesterol Is Correlated With the Incidence of Atherosclerosis & Coronary Heart Disease

Atherosclerosis is an inflammatory disease characterized by the deposition of cholesterol and cholesteryl ester from the plasma lipoproteins into the artery wall and is a major cause of heart disease. Elevated plasma cholesterol levels (>5.2 mmol/L) are one of the most important factors in promoting atherosclerosis, but it is now recognized that elevated blood triacylglycerol is also an independent risk factor. Diseases in which there is a prolonged elevation of levels of VLDL, IDL, chylomicron remnants, or LDL in the blood (eg, **diabetes mellitus**,

lipid nephrosis, **hypothyroidism**, and **other conditions of hyperlipidemia**) are often accompanied by premature or more severe atherosclerosis. There is also an inverse relationship between HDL (HDL₂) concentrations and coronary heart disease, making the **LDL:HDL cholesterol ratio a good predictive parameter**. This is consistent with the function of HDL in reverse cholesterol transport. Susceptibility to atherosclerosis varies widely among species, and humans are one of the few in which the disease can be induced by diets high in cholesterol.

Diet Can Play an Important Role in Reducing Serum Cholesterol

Hereditary factors play the most important role in determining the serum cholesterol concentrations of individuals; however, dietary and environmental factors also play a part, and the most beneficial of these is the substitution in the diet of **polyunsaturated and monounsaturated fatty acids** for saturated fatty acids. Plant oils such as corn oil and sunflower seed oil contain a high proportion of ω 6 polyunsaturated fatty acids, while olive oil contains a high concentration of monounsaturated fatty acids. ω 3 fatty acids found in fish oils are also beneficial (see Chapter 21). On the other hand, butter fat, beef fat, and palm oil contain a high proportion of saturated fatty acids. Sucrose and fructose have a greater effect in raising blood lipids, particularly triacylglycerols, than do other carbohydrates.

One of the mechanisms by which unsaturated fatty acids lower blood cholesterol levels is by the upregulation of LDL receptors on the cell surface by poly- and monounsaturated as compared with saturated fatty acids, causing an increase in the catabolic rate of LDL, the main atherogenic lipoprotein. ω 3 fatty acids are believed to be protective because of their anti-inflammatory and triacylglycerol lowering effects. In addition, saturated fatty acids cause the formation of smaller VLDL particles that contain relatively more cholesterol, and they are utilized by extrahepatic tissues at a slower rate than are larger particles—tendencies that may be regarded as atherogenic.

Lifestyle Affects the Serum Cholesterol Level

Additional factors considered to play a part in coronary heart disease include **high blood pressure**, **smoking**, **male gender**, **obesity (particularly abdominal obesity)**, **lack of exercise**, and **drinking soft as opposed to hard water**. Factors associated with elevation of plasma FFA followed by increased output of triacylglycerol and cholesterol into the circulation in VLDL include **emotional stress and coffee drinking**. Premenopausal women appear to be protected against many of these deleterious factors, and this is thought to be related to the beneficial effects of **estrogen**. There is an association between **moderate alcohol consumption** and a lower incidence of coronary heart disease. This may be due to elevation of HDL concentrations resulting from increased synthesis of apo A-I and changes in activity of cholesteryl ester transfer protein. It has been claimed that red wine is particularly beneficial, perhaps

because of its content of antioxidants. Regular exercise lowers plasma LDL but raises HDL. Triacylglycerol concentrations are also reduced, due most likely to increased insulin sensitivity, which enhances the expression of lipoprotein lipase.

When Diet Changes Fail, Hypolipidemic Drugs Can Reduce Serum Cholesterol & Triacylglycerol

A family of drugs known as **statins** have proved highly efficacious in lowering plasma cholesterol and preventing heart disease. Statins act by inhibiting HMG-CoA reductase and up-regulating LDL receptor activity. Examples currently in use include **atorvastatin**, **simvastatin**, **fluvastatin**, and **pravastatin**. **Ezetimibe** reduces blood cholesterol levels by inhibiting the absorption of cholesterol by the intestine by blocking uptake via the **Niemann-Pick C-like 1 protein**. Other drugs

used include fibrates such as **clofibrate**, **gemfibrozil**, and **nicotinic acid**, which act mainly to lower plasma triacylglycerols by decreasing the secretion of triacylglycerol and cholesterol-containing VLDL by the liver. Since PCSK9 reduces the number of LDL receptors exposed on the cell membrane it has the effect of raising blood cholesterol levels, thus drugs that inhibit its activity are potentially antiatherogenic and several such compounds are currently in clinical trials.

Primary Disorders of the Plasma Lipoproteins (Dyslipoproteinemias) Are Inherited

Inherited defects in lipoprotein metabolism lead to the primary condition of either **hypo-** or **hyperlipoproteinemia** (Table 26-1). For example, **familial hypercholesterolemia (FH)**, causes severe hypercholesterolemia and is also associated

TABLE 26-1 Primary Disorders of Plasma Lipoproteins (Dyslipoproteinemias)

Name	Defect	Remarks
Hypolipoproteinemias Abetalipoproteinemia	No chylomicrons, VLDL, or LDL are formed because of defect in the loading of apo B with lipid.	Rare; blood acylglycerols low; intestine and liver accumulate acylglycerols. Intestinal malabsorption. Early death avoidable by administration of large doses of fat-soluble vitamins, particularly vitamin E.
Familial alpha-lipoprotein deficiency Tangier disease Fish-eye disease Apo-A-I deficiencies	All have low or near absence of HDL.	Tendency toward hypertriacylglycerolemia as a result of absence of apo C-II, causing inactive LPL. Low LDL levels. Atherosclerosis in the elderly.
Hyperlipoproteinemias Familial lipoprotein lipase deficiency (type I)	Hypertriacylglycerolemia due to deficiency of LPL, abnormal LPL, or apo C-II deficiency causing inactive LPL.	Slow clearance of chylomicrons and VLDL. Low levels of LDL and HDL. No increased risk of coronary disease.
Familial hypercholesterolemia (type IIa)	Defective LDL receptors or mutation in ligand region of apo B-100.	Elevated LDL levels and hypercholesterolemia, resulting in atherosclerosis and coronary disease.
Familial type III hyperlipoproteinemia (broad beta disease, remnant removal disease, familial dysbetalipoproteinemia)	Deficiency in remnant clearance by the liver is due to abnormality in apo E. Patients lack isoforms E3 and E4 and have only E2, which does not react with the E receptor. ^a	Increase in chylomicron and VLDL remnants of density <1.019 (β -VLDL). Causes hypercholesterolemia, xanthomas, and atherosclerosis.
Familial hypertriacylglycerolemia (type IV)	Overproduction of VLDL often associated with glucose intolerance and hyperinsulinemia.	Cholesterol levels rise with the VLDL concentration. LDL and HDL tend to be subnormal. This type of pattern is commonly associated with coronary heart disease, type II diabetes mellitus, obesity, alcoholism, and administration of progestational hormones.
Familial hyperalphalipoproteinemia	Increased concentrations of HDL.	A rare condition apparently beneficial to health and longevity.
Hepatic lipase deficiency	Deficiency of the enzyme leads to accumulation of large triacylglycerol-rich HDL and VLDL remnants.	Patients have xanthomas and coronary heart disease.
Familial lecithin:cholesterol acyltransferase (LCAT) deficiency	Absence of LCAT leads to block in reverse cholesterol transport. HDL remains as nascent disks incapable of taking up and esterifying cholesterol.	Plasma concentrations of cholesteryl esters and lysolecithin are low. Present is an abnormal LDL fraction, lipoprotein X, found also in patients with cholestasis. VLDL is abnormal (β -VLDL).
Familial lipoprotein(a) excess	Lp(a) consists of 1 mol of LDL attached to 1 mol of apo(a). Apo(a) shows structural homologies to plasminogen.	Premature coronary heart disease due to atherosclerosis, plus thrombosis due to inhibition of fibrinolysis.

^aThere is an association between patients possessing the apo E4 allele and the incidence of Alzheimer disease. Apparently, apo E4 binds more avidly to β -amyloid found in neuritic plaques.

with premature atherosclerosis. The defect is most often in the gene for the LDL receptor, so that LDL is not cleared from the blood. In addition, diseases such as diabetes mellitus, hypothyroidism, kidney disease (nephrotic syndrome), and atherosclerosis are associated with secondary abnormal lipoprotein patterns that are very similar to one or another of the primary inherited conditions. Virtually all of the primary conditions are due to a defect at a stage in lipoprotein formation, transport, or degradation (see Figures 25–4, 26–5, and 26–6). Not all of the abnormalities are harmful.

SUMMARY

- Cholesterol is the precursor of all other steroids in the body, for example, corticosteroids, sex hormones, bile acids, and vitamin D. It also plays an important structural role in membranes and in the outer layer of lipoproteins.
- Cholesterol is synthesized in the body entirely from acetyl-CoA. Three molecules of acetyl-CoA form mevalonate via the important regulatory reaction for the pathway, catalyzed by HMG-CoA reductase. Next, a five-carbon isoprenoid unit is formed, and six of these condense to form squalene. Squalene undergoes cyclization to form the parent steroid lanosterol, which, after the loss of three methyl groups and other changes, forms cholesterol.
- Cholesterol synthesis in the liver is regulated partly by cholesterol in the diet. In tissues, cholesterol balance is maintained between the factors causing gain of cholesterol (eg, synthesis, uptake via the LDL or scavenger receptors) and the factors causing loss of cholesterol (eg, steroid synthesis, cholesteryl ester formation, excretion). The activity of the LDL receptor is modulated by cellular cholesterol levels to achieve this balance. In reverse cholesterol transport, HDL takes up cholesterol from the tissues and LCAT esterifies it and deposits it in the core of the particles. The cholesteryl ester in HDL is taken up by the liver, either directly or after transfer to VLDL, IDL, or LDL via the cholesteryl ester transfer protein.

- Excess cholesterol is excreted from the liver in the bile as cholesterol or bile salts. A large proportion of bile salts is absorbed into the portal circulation and returned to the liver as part of the enterohepatic circulation.
- Elevated levels of cholesterol present in VLDL, IDL, or LDL are associated with atherosclerosis, whereas high levels of HDL have a protective effect.
- Inherited defects in lipoprotein metabolism lead to a primary condition of hypo- or hyperlipoproteinemia. Conditions such as diabetes mellitus, hypothyroidism, kidney disease, and atherosclerosis exhibit secondary abnormal lipoprotein patterns that resemble certain primary conditions.

REFERENCES

- Agellon LB: Metabolism and function of bile acids. In *Biochemistry of Lipids, Lipoproteins and Membranes*, 5th ed. Vance DE, Vance JE (editors). Elsevier, 2008:423–440.
- Banach M, Rizzo M, Obradovic M, et al: PCSK9 inhibition—a novel mechanism to treat lipid disorders? *Curr Pharm Des* 2013;19:3869.
- Burg JS, Espenshade PJ: Regulation of HMG-CoA reductase in mammals and yeast. *Prog lipid Res* 2011;50:403.
- Chiang JY: Bile acids: regulation of synthesis. *J Lipid Res* 2009;50:1955.
- Denke MA: Dietary fats, fatty acids and their effects on lipoproteins. *Curr Atheroscler Rep* 2006;8:466.
- Djoussé L, Gaziano JM: Dietary cholesterol and coronary disease risk: a systematic review. *Curr Atheroscler Rep* 2009;11:418.
- Fernandez ML, West KL: Mechanisms by which dietary fatty acids modulate plasma lipids. *J Nutr* 2005;135:2075.
- Jiang XC, Zhou HW: Plasma lipid transfer proteins. *Curr Opin Lipidol* 2006;17:302.
- Liscum L: Cholesterol biosynthesis. In *Biochemistry of Lipids, Lipoproteins and Membranes*, 5th ed. Vance DE, Vance JE (editors). Elsevier, 2008:399–422.
- Perez-Sala D: Protein isoprenylation in biology and disease: general overview and perspectives from studies with genetically engineered animals. *Front Biosci* 2007;12:4456.

Exam Questions

Section V – Metabolism of Lipids

- Which one of the following statements concerning fatty acid molecules is CORRECT?
 - They consist of a carboxylic acid head group attached to a carbohydrate chain.
 - They are called polyunsaturated when they contain one or more carbon-carbon double bonds.
 - Their melting points increase with increasing unsaturation.
 - They almost always have their double bonds in the *cis* configuration when they occur naturally.
 - They occur in the body mainly in the form of free (nonesterified) fatty acids.
- Which one of the following is NOT a phospholipid?
 - Sphingomyelin
 - Plasmalogen
 - Cardiolipin
 - Galactosylceramide
 - Lysolecithin
- Which one of the following statements about gangliosides is INCORRECT?
 - They are derived from galactosylceramide.
 - They contain one or more molecules of sialic acid.
 - They are present in nervous tissue in high concentrations.
 - The ganglioside GM1 is the receptor for cholera toxin in the human intestine.
 - They function in cell-cell recognition.
- Which one of the following is a chain-breaking antioxidant?
 - Glutathione peroxidase
 - Selenium
 - Superoxide dismutase
 - EDTA
 - Catalase
- After they are produced from acetyl-CoA in the liver, ketone bodies are mainly used for which one of the following processes?
 - Excretion as waste products
 - Energy generation in the liver
 - Conversion to fatty acids for storage of energy
 - Generation of energy in the tissues
 - Generation of energy in red blood cells
- The subcellular site of the breakdown of long chain fatty acids to acetyl-CoA via β -oxidation is:
 - The cytosol
 - The matrix of the mitochondria
 - The endoplasmic reticulum
 - The mitochondrial intermembrane space
 - The Golgi apparatus
- Carnitine is needed for fatty acid oxidation BECAUSE:
 - It is a cofactor for acyl-CoA synthetase, which activates fatty acids for breakdown.
 - Long chain acyl-CoA (“activated fatty acids”) need to enter the mitochondrial matrix to be oxidized, but cannot cross the outer mitochondrial membrane. Transfer of the acyl group from CoA to carnitine enables translocation to occur.
 - Long chain acyl-CoA (“activated fatty acids”) need to enter the mitochondrial matrix to be oxidized, but cannot cross the outer mitochondrial membrane. Transfer of the acyl group from CoA to carnitine enables translocation to occur.
 - Long chain acyl-CoA (“activated fatty acids”) need to enter the mitochondrial intermembrane space to be oxidized, but cannot cross the inner mitochondrial membrane. Transfer of the acyl group from CoA to carnitine enables translocation to occur.
 - It prevents the breakdown of long chain fatty acyl CoA in the mitochondrial intermembrane space.
- The breakdown of one molecule of a C16 fully saturated fatty acid (palmitic acid) by β -oxidation lead to the formation of:
 - 8 FADH₂, 8 NADH and 8 acetyl CoA molecules
 - 7 FADH₂, 7 NADH and 7 acetyl CoA molecules
 - 8 FADH₂, 8 NADH and 7 acetyl CoA molecules
 - 7 FADH₂, 8 NADH and 8 acetyl CoA molecules
 - 7 FADH₂, 7 NADH and 8 acetyl CoA molecules
- Malonyl CoA, the first intermediate in fatty acid synthesis, is an important regulator of fatty acid metabolism BECAUSE:
 - Its formation from acetyl CoA and bicarbonate by the enzyme acetyl CoA carboxylase is the main rate-limiting step in fatty acid synthesis.
 - It prevents entry of fatty acyl groups into the matrix of the mitochondria because it is a potent inhibitor of carnitine palmitoyl transferase-I.
 - It prevents entry of fatty acyl groups into the matrix of the mitochondria because it is a potent inhibitor of carnitine palmitoyl transferase-II.
 - It prevents entry of fatty acyl groups into the matrix of the mitochondria because it is a potent inhibitor of carnitine-acylcarnitine translocase.
 - It inhibits the synthesis of fatty acyl CoA.
- α -Linolenic acid is considered to be nutritionally essential in humans BECAUSE:
 - It is an ω 3 fatty acid.
 - It contains three double bonds.
 - In humans double bonds cannot be introduced into fatty acids beyond the Δ 9 position.
 - In humans double bonds cannot be introduced into fatty acids beyond the Δ 12 position.
 - Human tissues are unable to introduce a double bond in the Δ 9 position of fatty acids.

11. Inactivation of acetyl CoA carboxylase is favored WHEN:
 - A. Cytosolic citrate levels are high.
 - B. It is in a polymeric form.
 - C. Palmitoyl CoA levels are low.
 - D. The tricarboxylate transporter is inhibited.
 - E. It is dephosphorylated.
12. Which one of the following eicosanoids is synthesized from linoleic acid via the cyclooxygenase pathway?
 - A. Prostaglandin E₁ (PGE₁)
 - B. Leukotriene A₃ (LTA₃)
 - C. Prostaglandin E₃ (PGE₃)
 - D. Lipoxin A₄ (LXA₄)
 - E. Thromboxane A₃ (TXA₃)
13. Which one of the following enzymes is inhibited by the nonsteroidal anti-inflammatory drug (NSAID) aspirin?
 - A. Lipoxygenase
 - B. Prostacyclin synthase
 - C. Cyclooxygenase
 - D. Thromboxane synthase
 - E. Δ6 desaturase
14. Which one of the following is the major product of fatty acid synthase?
 - A. Acetyl-CoA
 - B. Oleate
 - C. Palmitoyl-CoA
 - D. Acetoacetate
 - E. Palmitate
15. Fatty acids are broken down by repeated removal of two carbon fragments as acetyl CoA in the β-oxidation cycle, and synthesized by repeated condensation of acetyl CoAs until a long chain saturated fatty acid with an even number of carbons is formed. Since fatty acids need to be broken down when energy is short supply and synthesized when it is plentiful, there are important differences between the two processes which help cells to regulate them efficiently. Which one of the following statements concerning these differences is INCORRECT?
 - A. Fatty acid breakdown takes place inside mitochondria, while synthesis occurs in the cytosol.
 - B. Fatty acid breakdown uses NAD⁺ and produces NADH, while synthesis uses NADPH and produces NADP.
 - C. Fatty acyl groups are activated for breakdown using CoA and for synthesis using acyl carrier protein.
 - D. Transport across the mitochondrial membrane of fatty acyl groups and acetyl CoA is required for fatty acid breakdown and synthesis, respectively.
 - E. Glucagon promotes fatty acid synthesis and inhibits fatty acid breakdown.
16. Hormone sensitive lipase, the enzyme which mobilizes fatty acids from triacylglycerol stores in adipose tissue is inhibited by:
 - A. Glucagon
 - B. ACTH
 - C. Epinephrine
 - D. Vasopressin
 - E. Prostaglandin E
17. Which one of the following best describes the action of phospholipase C?
 - A. It releases the fatty acyl chain from the *sn*-2 position of a phospholipid.
 - B. It cleaves a phospholipid into its phosphate-containing head group and a diacylglycerol.
 - C. It releases the head group of a phospholipid, leaving phosphatidic acid.
 - D. It releases the fatty acyl chain from the *sn*-1 position of a phospholipid.
 - E. It releases the fatty acyl chains from the *sn*-1 and *sn*-2 positions of a phospholipid.
18. Tay Sachs disease is a lipid storage disease caused by a genetic defect in deficiency which one of the following enzymes:
 - A. β-Galactosidase
 - B. Sphingomyelinase
 - C. Ceramidase
 - D. Hexosaminidase A
 - E. β-Glucosidase
19. Which of the plasma lipoproteins is best described as follows: synthesized in the intestinal mucosa, containing a high concentration of triacylglycerol and responsible for the transport of dietary lipids in the circulation?
 - A. Chylomicrons
 - B. High-density lipoprotein
 - C. Intermediate density lipoprotein
 - D. Low-density lipoprotein
 - E. Very low density lipoprotein
20. Which of the plasma lipoproteins is best described as follows: synthesized in the liver, containing a high concentration of triacylglycerol and mainly cleared from the circulation by adipose tissue and muscle?
 - A. Chylomicrons
 - B. High-density lipoprotein
 - C. Intermediate density lipoprotein
 - D. Low-density lipoprotein
 - E. Very low density lipoprotein
21. Which of the plasma lipoproteins is best described as follows: formed in the circulation by removal of triacylglycerol from very low density lipoprotein, contains cholesterol taken up from high-density lipoprotein delivers cholesterol to extrahepatic tissues?
 - A. Chylomicrons
 - B. High-density lipoprotein
 - C. Intermediate density lipoprotein
 - D. Low-density lipoprotein
 - E. Very low density lipoprotein
22. Which of the following will be elevated in the bloodstream about 2 hours after eating a high-fat meal?
 - A. Chylomicrons
 - B. High-density lipoprotein
 - C. Ketone bodies
 - D. Nonesterified fatty acids
 - E. Very low density lipoprotein

23. Which of the following will be elevated in the bloodstream about 4 hours after eating a high-fat meal?
- Chylomicrons
 - High-density lipoprotein
 - Ketone bodies
 - Nonesterified fatty acids
 - Very low density lipoprotein
24. Which one of the following processes is NOT involved in the efflux of cholesterol from extrahepatic tissues and its delivery to the liver for excretion by HDL?
- Efflux of cholesterol from tissues to pre- β HDL via ABCA1.
 - Esterification of cholesterol to cholesteryl ester by LCAT to form HDL₃.
 - Transfer of cholesteryl ester from HDL to VLDL, IDL, and LDL by the action of cholesteryl ester transfer protein (CETP).
 - Efflux of cholesterol from tissues to HDL₃ via SR-B1 and ABCG1.
 - Selective uptake of cholesteryl ester from HDL₂ by the liver via SR-B1.
25. Which one of the following statements concerning chylomicrons is CORRECT?
- Chylomicrons are made inside intestinal cells and secreted into lymph, where they acquire apolipoproteins B and C.
 - The core of chylomicrons contains triacylglycerol and phospholipids.
 - The enzyme hormone sensitive lipase acts on chylomicrons to release fatty acids from triacylglycerol when they are bound to the surface of endothelial cells in blood capillaries.
 - Chylomicron remnants differ from chylomicrons in that they are smaller and contain a lower proportion of triacylglycerol and a higher proportion of cholesterol.
 - Chylomicrons are taken up by the liver.
26. Which one of the following statements concerning the biosynthesis of cholesterol is CORRECT?
- The rate-limiting step is the formation of 3-hydroxy-3-methylglutaryl-CoA (HMG-CoA) by the enzyme HMG-CoA synthase.
 - Synthesis occurs in the cytosol of the cell.
 - All the carbon atoms in the cholesterol synthesized originate from acetyl-CoA.
 - Squalene is the first cyclic intermediate in the pathway.
 - The initial substrate is mevalonate.
27. The class of drugs called statins have proved very effective against hypercholesterolemia, a major cause of atherosclerosis and associated cardiovascular disease. These drugs reduce plasma cholesterol levels by:
- Preventing absorption of cholesterol from the intestine.
 - Increasing the excretion of cholesterol from the body via conversion to bile acids.
 - Inhibiting the conversion of 3-hydroxy-3-methylglutaryl-CoA to mevalonate in the pathway for cholesterol biosynthesis.
 - Increasing the rate of degradation of 3-hydroxy-3-methylglutaryl CoA reductase.
 - Stimulating the activity of the LDL receptor in the liver.
28. Which of the following statements about bile acids (or bile salts) is INCORRECT:
- Primary bile acids are synthesized in the liver from cholesterol.
 - Bile acids are needed for the breakdown of fats by pancreatic lipase.
 - Secondary bile acids are produced by modification of primary bile acids in the liver.
 - Bile acids facilitate the absorption of the products of lipid digestion in the jejunum.
 - Bile acids are recirculated between the liver and the small intestine in the enterohepatic circulation.
29. A 35-year-old man with severe hypercholesterolemia has a family history of deaths at a young age from heart disease and stroke. Which of the following genes is likely to be defective?
- Apolipoprotein E
 - The LDL receptor
 - Lipoprotein lipase
 - PCSK9
 - LCAT
30. The recently discovered protein, proprotein convertase subtilisin/kexin type 9 (PCSK9), has been identified as a potential target for antiatherogenic drugs BECAUSE:
- It decreases the number of LDL receptors exposed at the cell surface, thus LDL uptake is lowered and blood cholesterol levels rise.
 - It inhibits the binding of apoB to the LDL receptor, thus blocking uptake of the lipoprotein and raising blood cholesterol levels.
 - It increases the absorption of cholesterol from the intestine.
 - It prevents the breakdown of cholesterol to bile acids in the liver.
 - It increases the synthesis and secretion of VLDL in the liver, leading to increased LDL formation in the blood.

This page intentionally left blank

Biosynthesis of the Nutritionally Nonessential Amino Acids

Victor W. Rodwell, PhD

OBJECTIVES

*After studying this chapter,
you should be able to:*

- Explain why the absence from the diet of certain amino acids that are present in most proteins is not deleterious to human health.
- Appreciate the distinction between the terms “essential” and “nutritionally essential” amino acids, and identify the amino acids that are nutritionally nonessential.
- Name the intermediates of the citric acid cycle and of glycolysis that are precursors of aspartate, asparagine, glutamate, glutamine, glycine, and serine.
- Illustrate the key role of transaminases in amino acid metabolism.
- Explain the process by which the 4-hydroxyproline and 5-hydroxylysine of proteins such as collagen are formed.
- Describe the clinical presentation of scurvy, and provide a biochemical explanation for why a severe deprivation of vitamin C (ascorbic acid) results in this nutritional disorder.
- Appreciate that, despite the toxicity of selenium, selenocysteine is an essential component of several mammalian proteins.
- Define and outline the reaction catalyzed by a mixed-function oxidase.
- Identify the role of tetrahydrobiopterin in tyrosine biosynthesis.
- Indicate the role of a modified tRNA in the cotranslational insertion of selenocysteine into proteins.

BIOMEDICAL IMPORTANCE

Amino acid deficiency states can result if nutritionally essential amino acids are absent from the diet, or are present in inadequate amounts. Examples in certain regions of West Africa include **kwashiorkor**, which results when a child is weaned onto a starchy diet poor in protein, and **marasmus**, in which both caloric intake and specific amino acids are deficient. Patients with short bowel syndrome unable to absorb sufficient quantities of calories and nutrients suffer from significant

nutritional and metabolic abnormalities. Both the nutritional disorder **scurvy**, a dietary deficiency of vitamin C, and specific genetic disorders are associated with an impaired ability of connective tissue to form hydroxyproline and hydroxylysine. The resulting conformational instability of collagen results in bleeding gums, swelling joints, poor wound healing, and ultimately in death. **Menkes syndrome**, characterized by kinky hair and growth retardation, results from a dietary deficiency of copper, an essential cofactor for the enzyme lysyl oxidase that functions in formation of the covalent cross-links that

strengthen collagen fibers. Genetic disorders of collagen biosynthesis include several forms of **osteogenesis imperfecta**, characterized by fragile bones, and **Ehlers-Danlos syndrome**, a group of connective tissue disorders that result in mobile joints and skin abnormalities due to defects in the genes that encode enzymes including lysyl hydroxylase.

NUTRITIONALLY ESSENTIAL & NUTRITIONALLY NONESSENTIAL AMINO ACIDS

While often employed with reference to amino acids, the terms “essential” and “nonessential” are misleading since all 20 common amino acids are essential to ensure health. Of these 20 amino acids, 8 *must* be present in the human diet, and thus are best termed “*nutritionally essential*.” The other 12 amino acids are “*nutritionally nonessential*” since they need not be present in the diet (Table 27-1). The distinction between these two classes of amino acids was established in the 1930s by feeding human subjects purified amino acids in place of protein. Subsequent biochemical investigations revealed the reactions and intermediates involved in the biosynthesis of all 20 amino acids. Amino acid deficiency disorders are endemic in certain regions of West Africa where diets rely heavily on grains that are poor sources of tryptophan and lysine. These nutritional disorders include kwashiorkor, which results when a child is weaned onto a starchy diet poor in protein, and marasmus, in which both caloric intake and specific amino acids are deficient.

Lengthy Metabolic Pathways Form the Nutritionally Essential Amino Acids

The existence of nutritional requirements suggests that dependence on an external supply of a given nutrient can be of greater

TABLE 27-1 Amino Acid Requirements of Humans

Nutritionally Essential	Nutritionally Nonessential
Arginine ^a	Alanine
Histidine	Asparagine
Isoleucine	Aspartate
Leucine	Cysteine
Lysine	Glutamate
Methionine	Glutamine
Phenylalanine	Glycine
Threonine	Hydroxyproline ^b
Tryptophan	Hydroxylysine ^b
Valine	Proline
	Serine
	Tyrosine

^aNutritionally “semiessential.” Synthesized at rates inadequate to support growth of children.

^bNot necessary for protein synthesis, but is formed during post-translational processing of collagen.

TABLE 27-2 Enzymes Required for the Synthesis of Amino Acids from Amphibolic Intermediates

Number of Enzymes Required to Synthesize			
Nutritionally Essential		Nutritionally Nonessential	
Arg ^a	7	Ala	1
His	6	Asp	1
Thr	6	Asn ^b	1
Met	5 (4 shared)	Glu	1
Lys	8	Gln ^a	1
Ile	8 (6 shared)	Hyl ^c	1
Val	6 (all shared)	Hyp ^d	1
Leu	7 (5 shared)	Pro ^a	3
Phe	10	Ser	3
Trp	5 (8 shared)	Gly ^e	1
	59	Cys ^f	2
		Tyr ^g	1
			17

^aFrom Glu, ^bFrom Asp, ^cFrom Lys, ^dFrom Pro, ^eFrom Ser, ^fFrom Ser plus S²⁻, ^gFrom Phe.

survival value than the ability to biosynthesize it. Why? If a specific nutrient is present in the food, an organism that can synthesize it will transfer to its progeny genetic information of *negative* survival value. The survival value is negative rather than nil because ATP and nutrients are required to synthesize “unnecessary” DNA—even if specific encoded genes are no longer expressed. The number of enzymes required by prokaryotic cells to synthesize the nutritionally essential amino acids is large relative to the number of enzymes required to synthesize the nutritionally nonessential amino acids (Table 27-2). This suggests a survival advantage in retaining the ability to manufacture “easy” amino acids while losing the ability to make “difficult” amino acids. The metabolic pathways that form the nutritionally essential amino acids occur in plants and bacteria, but not in humans, and thus are not discussed. This chapter addresses the reactions and intermediates involved in the biosynthesis by human tissues of the 12 nutritionally *nonessential* amino acids and selected nutritional and metabolic disorders associated with their metabolism.

BIOSYNTHESIS OF THE NUTRITIONALLY NONESSENTIAL AMINO ACIDS

Glutamate

Glutamate, the precursor of the so-called “glutamate family” of amino acids, is formed by the reductive amidation of the citric acid cycle α -ketoglutarate, a reaction catalyzed by mitochondrial glutamate dehydrogenase (Figure 27-1). The reaction

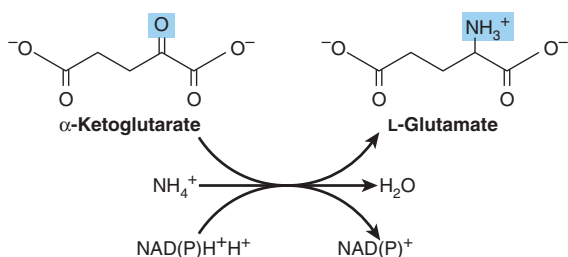

FIGURE 27-1 The reaction catalyzed by glutamate dehydrogenase (EC 1.4.1.3).

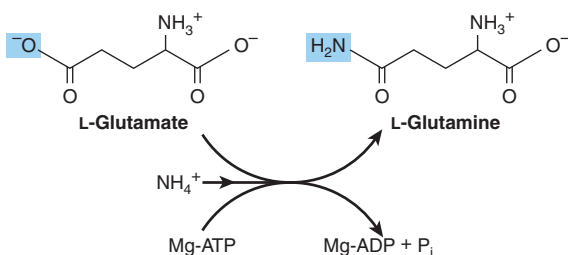

FIGURE 27-2 The reaction catalyzed by glutamine synthetase (EC 6.3.1.2).

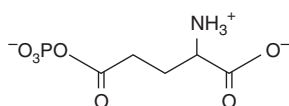

FIGURE 27-3 γ -Glutamyl phosphate.

strongly favors glutamate synthesis, which lowers the concentration of cytotoxic ammonium ion.

Glutamine

The amidation of glutamate to glutamine catalyzed by glutamine synthetase, (Figure 27-2) involves the intermediate formation of γ -glutamyl phosphate (Figure 27-3). Following the ordered binding of glutamate and ATP, glutamate attacks the γ -phosphorus of ATP, forming γ -glutamyl phosphate and ADP. NH_4^+ then binds, and uncharged NH_3 attacks γ -glutamyl phosphate. Release of P_i and of a proton from the γ -amino group of the tetrahedral intermediate then allows release of the product, glutamine.

Alanine & Aspartate

Transamination of pyruvate forms alanine (Figure 27-4). Similarly, transamination of oxaloacetate forms aspartate.

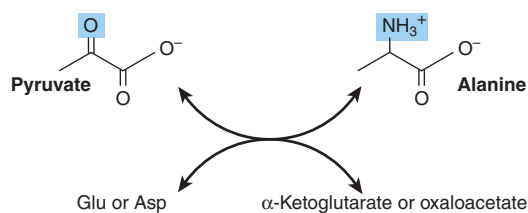

FIGURE 27-4 Formation of alanine by transamination of pyruvate. The amino donor may be glutamate or aspartate. The other product thus is α -ketoglutarate or oxaloacetate.

Glutamate Dehydrogenase, Glutamine Synthetase & Aminotransferases Play Central Roles in Amino Acid Biosynthesis

The combined action of the enzymes glutamate dehydrogenase, glutamine synthetase, and the aminotransferases (Figures 27-1, 27-2 and 27-4) converts inorganic ammonium ion into the α -amino nitrogen of amino acids.

Asparagine

The conversion of aspartate to asparagine, catalyzed by asparagine synthetase, (Figure 27-5), resembles the glutamine synthetase reaction (Figure 27-2), but glutamine, rather than ammonium ion, provides the nitrogen. Bacterial asparagine synthetases can, however, also use ammonium ion. The reaction involves the intermediate formation of aspartyl phosphate (Figure 27-6). The coupled hydrolysis of PP_i to P_i by pyrophosphatase, EC 3.6.1.1, ensures that the reaction is strongly favored.

Serine

Oxidation of the α -hydroxyl group of the glycolytic intermediate 3-phosphoglycerate, catalyzed by 3-phosphoglycerate dehydrogenase, converts it to 3-phosphohydroxypyruvate. Transamination and subsequent dephosphorylation then form serine (Figure 27-7).

Glycine

Glycine aminotransferases can catalyze the synthesis of glycine from glyoxylate and glutamate or alanine. Unlike most aminotransferase reactions, these strongly favor glycine synthesis. Additional important mammalian routes for glycine formation are from choline (Figure 27-8) and from serine (Figure 27-9).

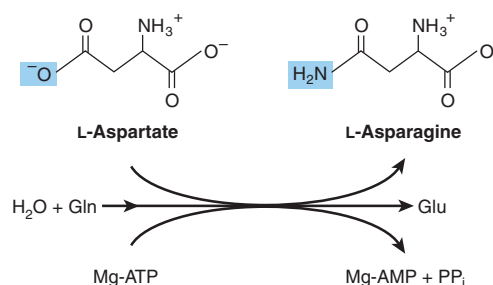

FIGURE 27-5 The reaction catalyzed by asparagine synthetase (EC 6.3.5.4). Note similarities to and differences from the glutamine synthetase reaction (Figure 27-2).

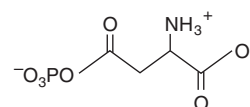

FIGURE 27-6 Aspartyl phosphate.

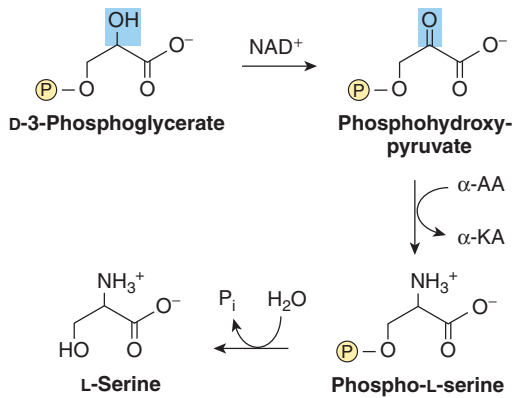

FIGURE 27-7 Serine biosynthesis. Oxidation of 3-phosphoglycerate is catalyzed by 3-phosphoglycerate dehydrogenase (EC 1.1.1.95). Transamination converts phosphohydroxypyruvate to phosphoserine. Hydrolytic removal of the phosphoryl group catalyzed by phosphoserine hydrolase (EC 3.1.3.3) then forms L-serine.

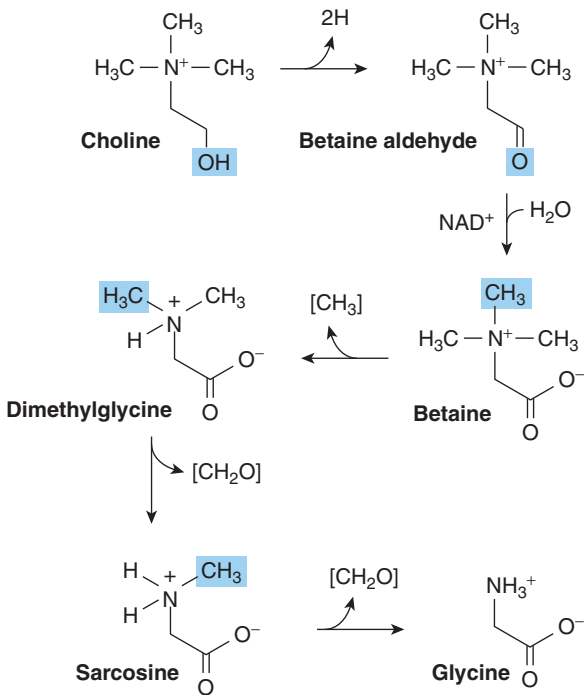

FIGURE 27-8 Formation of glycine from choline. Catalysts include choline dehydrogenase (EC 1.1.91.1), betaine dehydrogenase (EC 1.2.1.8), betaine-homocysteine *N*-methyltransferase, sarcosine dehydrogenase (EC 1.5.8.3), and dimethylglycine dehydrogenase (EC 1.5.99.2).

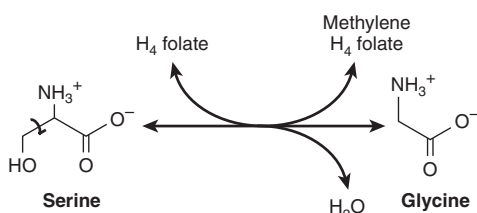

FIGURE 27-9 Interconversion of serine and glycine, catalyzed by serine hydroxymethyltransferase (EC 2.1.2.1). The reaction is freely reversible. (H_4 folate, tetrahydrofolate.)

Proline

The initial reaction of proline biosynthesis converts the γ -carboxyl group of glutamate to the mixed acid anhydride of glutamate γ -phosphate (Figure 27-3). Subsequent reduction forms glutamate γ -semialdehyde, which following spontaneous cyclization is reduced to L-proline (Figure 27-10).

Cysteine

While not nutritionally essential, cysteine is formed from methionine, which is nutritionally essential. Following conversion of

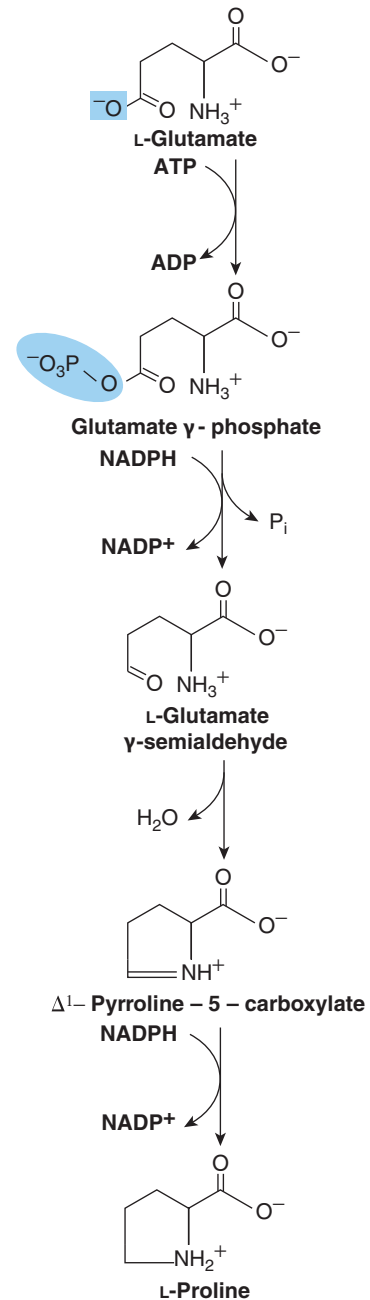

FIGURE 27-10 Biosynthesis of proline from glutamate.

Catalysts for these reactions are glutamate 5-kinase (EC 2.7.2.11), glutamate semialdehyde dehydrogenase (EC 1.2.1.41), and pyrroline 5-carboxylate reductase (EC 1.5.1.2). Ring closure of glutamate semialdehyde is spontaneous.

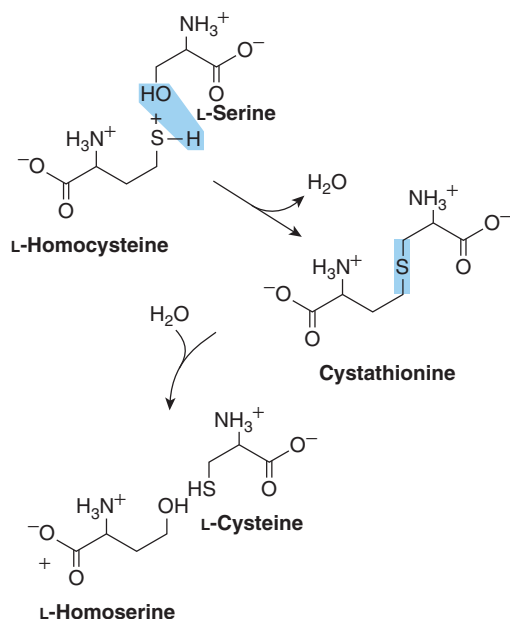

FIGURE 27-11 Conversion of homocysteine and serine to homoserine and cysteine. The sulfur of cysteine derives from methionine and the carbon skeleton from serine. The catalysts are cystathionine β -synthetase (EC 4.2.1.22) and cystathionine lyase (EC 4.4.1.1).

methionine to homocysteine (see Figure 29-19), homocysteine and serine form cystathionine, whose hydrolysis forms cysteine and homoserine (Figure 27-11).

Tyrosine

Phenylalanine hydroxylase (EC 1.14.16.1) converts phenylalanine to tyrosine (Figure 27-12). If the diet contains adequate

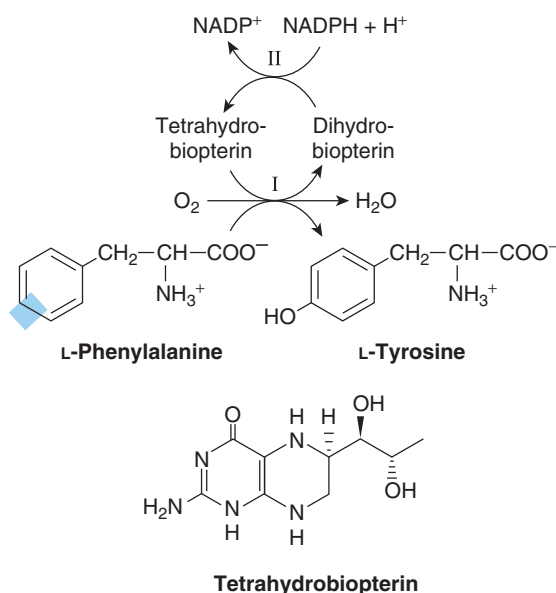

FIGURE 27-12 Conversion of phenylalanine to tyrosine by phenylalanine hydroxylase (EC 1.14.16.1). Two distinct enzymatic activities are involved. Activity II catalyzes reduction of dihydrobiopterin by NADPH, and activity I the reduction of O₂ to H₂O and of phenylalanine to tyrosine. This reaction is associated with several defects of phenylalanine metabolism discussed in Chapter 29.

quantities of the nutritionally essential amino acid phenylalanine, tyrosine is nutritionally nonessential. However, since the phenylalanine hydroxylase reaction is irreversible, dietary tyrosine cannot replace phenylalanine. Catalysis by this mixed-function oxidase incorporates one atom of O₂ into the *para* position of phenylalanine and reduces the other atom to water. Reducing power, provided as tetrahydrobiopterin derives ultimately from NADPH (Figure 27-12).

Hydroxyproline & Hydroxylysine

Hydroxyproline and hydroxylysine occur principally in collagen. Since there is no tRNA for either hydroxylated amino acid, neither dietary hydroxyproline nor dietary hydroxylysine is incorporated during protein synthesis. Peptidyl hydroxyproline and hydroxylysine arise from proline and lysine, but only after these amino acids have been incorporated into peptides. Hydroxylation of peptidyl prolyl and peptidyl lysyl residues, catalyzed by **prolyl hydroxylase** and **lysyl hydroxylase** of skin, skeletal muscle, and granulating wounds requires, in addition to the substrate, molecular O₂, ascorbate, Fe²⁺, and α -ketoglutarate (Figure 27-13). For every mole of proline or lysine hydroxylated, one mole of α -ketoglutarate is decarboxylated to succinate. The hydroxylases are mixed-function oxidases. One atom of O₂ is incorporated into proline or lysine, the other into succinate (Figure 27-13). A deficiency of the vitamin C required for these two hydroxylases results in **scurvy**, in which bleeding gums, swelling joints, and impaired wound healing result from the impaired stability of collagen (see Chapters 5 and 50).

Valine, Leucine, & Isoleucine

While leucine, valine, and isoleucine are all nutritionally essential amino acids, tissue aminotransferases reversibly interconvert all three amino acids and their corresponding α -keto acids. These α -keto acids thus can replace their amino acids in the diet.

Selenocysteine, the 21st Amino Acid

While the occurrence of selenocysteine (Figure 27-14) in proteins is uncommon, at least 25 human selenoproteins are known. Selenocysteine is present at the active site of several

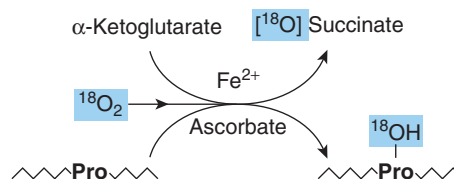

FIGURE 27-13 Hydroxylation of a proline-rich peptide. Molecular oxygen is incorporated into both succinate and proline. Peptidyl prolyl 4-hydroxylase (EC 1.14.11.2) thus is a mixed function oxidase. Lysyl 5-hydroxylase (EC 1.14.11.4) catalyzes an analogous reaction.

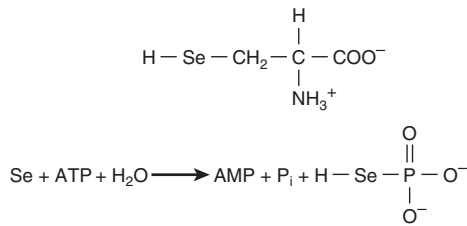

FIGURE 27-14 Selenocysteine (top) and the reaction catalyzed by selenophosphate synthetase (EC 2.7.9.3) (bottom).

human enzymes that catalyze redox reactions. Examples include thioredoxin reductase, glutathione peroxidase, and the deiodinase that converts thyroxine to triiodothyronine. Where present, selenocysteine participates in the catalytic mechanism of these enzymes. Significantly, the replacement of selenocysteine by cysteine can actually impair catalytic activity. Impairments in human selenoproteins have been implicated in tumorigenesis and atherosclerosis, and are associated with selenium deficiency cardiomyopathy (Keshan disease).

Biosynthesis of selenocysteine requires cysteine, selenate (SeO_4^{2-}), ATP, a specific tRNA, and several enzymes. Serine provides the carbon skeleton of selenocysteine. Selenophosphate, formed from ATP and selenate (Figure 27-14), serves as the selenium donor. Unlike hydroxyproline or hydroxylysine, selenocysteine arises cotranslationally during its incorporation into peptides. The UGA anticodon of the unusual tRNA called tRNA^{Sec} normally signals STOP. The ability of the protein synthetic apparatus to identify a selenocysteine-specific UGA codon involves the selenocysteine insertion element, a stem-loop structure in the untranslated region of the mRNA. tRNA^{Sec} is first charged with serine by the ligase that charges tRNA^{Ser} . Subsequent replacement of the serine oxygen by selenium involves selenophosphate formed by selenophosphate synthetase (Figure 27-14). Successive enzyme-catalyzed reactions convert cysteyle-tRNA^{Sec} to aminoacrylyl-tRNA^{Sec} and then to selenocysteyl-tRNA^{Sec}. In the presence of a specific elongation factor that recognizes selenocysteyl-tRNA^{Sec}, selenocysteine can then be incorporated into proteins.

SUMMARY

- All vertebrates can form certain amino acids from amphibolic intermediates or from other dietary amino acids. The intermediates and the amino acids to which they give rise are α -ketoglutarate (Glu, Gln, Pro, Hyp), oxaloacetate (Asp, Asn), and 3-phosphoglycerate (Ser, Gly).
- Cysteine, tyrosine, and hydroxylysine are formed from nutritionally essential amino acids. Serine provides the carbon skeleton and homocysteine the sulfur for cysteine biosynthesis.
- In Scurvy, a nutritional disease that results from a deficiency of vitamin C, impaired hydroxylation of peptidyl proline and peptidyl lysine results in a failure to provide the substrates for cross-linking of maturing collagens.
- Phenylalanine hydroxylase converts phenylalanine to tyrosine. Since the reaction catalyzed by this mixed function oxidase is irreversible, tyrosine cannot give rise to phenylalanine.
- Neither dietary hydroxyproline nor hydroxylysine is incorporated into proteins because no codon or tRNA dictates their insertion into peptides.
- Peptidyl hydroxyproline and hydroxylysine are formed by hydroxylation of peptidyl proline or lysine in reactions catalyzed by mixed-function oxidases that require vitamin C as cofactor.
- Selenocysteine, an essential active site residue in several mammalian enzymes, arises by cotranslational insertion from a previously modified tRNA.

REFERENCES

- Beckett GJ, Arthur JR: Selenium and endocrine systems. *J Endocrinol* 2005;184:455.
- Bender, DA: *Amino Acid Metabolism*, 3rd ed. Wiley, 2012.
- Donovan J, Copeland PR: The efficiency of selenocysteine incorporation is regulated by translation initiation factors. *J Mol Biol* 2010;400:659.
- Kilberg MS: Asparagine synthetase chemotherapy. *Annu Rev Biochem* 2006;75:629.
- Scriver CR, Sly WS, Childs B, et al (editors): *The Metabolic and Molecular Bases of Inherited Disease*, 8th ed. McGraw-Hill, 2001.
- Stickel F, Inderbitzin D, Candinas D: Role of nutrition in liver transplantation for end-stage chronic liver disease. *Nutr Rev* 2008;66:47.
- Turanov AA, Shchedrina VA, Everley RA et al: Selenoprotein S is involved in maintenance and transport of multiprotein complexes. *Biochem J*. 2014;462:555.

Catabolism of Proteins & of Amino Acid Nitrogen

Victor W. Rodwell, PhD

OBJECTIVES

*After studying this chapter,
you should be able to:*

- Describe protein turnover, indicate the mean rate of protein turnover in healthy individuals, and provide examples of human proteins that are degraded at rates greater than the mean rate.
- Outline the events in protein turnover by both ATP-dependent and ATP-independent pathways, and indicate the roles in protein degradation played by the proteasome, ubiquitin, cell surface receptors, circulating asialoglycoproteins, and lysosomes.
- Indicate how the ultimate end products of nitrogen catabolism in mammals differ from those in birds and fish.
- Illustrate the central roles of transaminases (aminotransferases), of glutamate dehydrogenase, and of glutaminase in human nitrogen metabolism.
- Use structural formulas to represent the reactions that convert NH_3 , CO_2 , and the amide nitrogen of aspartate into urea, and identify the subcellular locations of the enzymes that catalyze urea biosynthesis.
- Indicate the roles of allosteric regulation and of acetylglutamate in the regulation of the earliest steps in urea biosynthesis.
- Explain why metabolic defects in different enzymes of urea biosynthesis, although distinct at the molecular level, present similar clinical signs and symptoms.
- Describe both the classical approaches and the role of tandem mass spectrometry in screening neonates for inherited metabolic diseases.

BIOMEDICAL IMPORTANCE

In normal adults, nitrogen intake matches nitrogen excreted. Positive nitrogen balance, an excess of ingested over excreted nitrogen, accompanies growth and pregnancy. Negative nitrogen balance, where output exceeds intake, may follow surgery, advanced cancer, and the nutritional disorders kwashiorkor and marasmus. Genetic disorders that result from defects in the genes that encode ubiquitin, ubiquitin ligases, or deubiquitinating enzymes that participate in the degradation of certain proteins include Angelman syndrome, juvenile Parkinson's disease, von Hippel-Lindau syndrome, and congenital polycythemia. This chapter describes how the nitrogen of amino acids is converted to urea, and the metabolic disorders that accompany defects in this process. Ammonia, which is highly toxic, arises in humans primarily from the α -amino nitrogen of amino acids. Tissues therefore convert ammonia to the amide nitrogen of the nontoxic

amino acid glutamine. Subsequent deamination of glutamine in the liver releases ammonia, which is efficiently converted to urea, which is not toxic. However, if liver function is compromised, as in cirrhosis or hepatitis, elevated blood ammonia levels generate clinical signs and symptoms. Each enzyme of the urea cycle provides examples of metabolic defects and their physiologic consequences. In addition, the urea cycle provides a useful molecular model for the study of other human metabolic defects.

PROTEIN TURNOVER

The continuous degradation and synthesis (turnover) of cellular proteins occur in all forms of life. Each day, humans turn over 1% to 2% of their total body protein, principally muscle protein. High rates of protein degradation occur in tissues that are undergoing structural rearrangement, for example, uterine tissue during pregnancy, skeletal muscle in starvation,

and tadpole tail tissue during metamorphosis. While approximately 75% of the amino acids liberated by protein degradation are reutilized, the remaining excess free amino acids are not stored for future use. Amino acids not immediately incorporated into new protein are rapidly degraded. The major portion of the carbon skeletons of the amino acids is converted to amphibolic intermediates, while in humans the amino nitrogen is converted to urea and excreted in the urine.

PROTEASES & PEPTIDASES DEGRADE PROTEINS TO AMINO ACIDS

The relative susceptibility of a protein to degradation is expressed as its **half-life** ($t_{1/2}$), the time required to lower its concentration to half of its initial value. Half-lives of liver proteins range from under 30 minutes to over 150 hours. Typical “house-keeping” enzymes such as those of glycolysis, have $t_{1/2}$ values of over 100 hours. By contrast, key regulatory enzymes may have $t_{1/2}$ values as low as 0.5 to 2 hours. PEST sequences, regions rich in proline (P), glutamate (E), serine (S), and threonine (T), target some proteins for rapid degradation. Intracellular proteases hydrolyze internal peptide bonds. The resulting peptides are then degraded to amino acids by endopeptidases that hydrolyze internal peptide bonds, and by aminopeptidases and carboxypeptidases that remove amino acids sequentially from the amino- and carboxyl-termini, respectively.

ATP-Independent Degradation

Degradation of blood glycoproteins (see Chapter 46) follows loss of a sialic acid moiety from the nonreducing ends of their oligosaccharide chains. Asialoglycoproteins are then internalized by liver-cell asialoglycoprotein receptors and degraded by lysosomal proteases. Extracellular, membrane-associated, and long-lived intracellular proteins are also degraded in lysosomes by ATP-independent processes.

ATP & Ubiquitin-Dependent Degradation

Degradation of regulatory proteins with short half-lives and of abnormal or misfolded proteins occurs in the cytosol, and requires ATP and **ubiquitin**. Named based on its presence in all eukaryotic cells, ubiquitin is a small (8.5 kDa, 76 residue) polypeptide that targets many intracellular proteins for degradation. The primary structure of ubiquitin is highly conserved. Only three of 76 residues differ between yeast and human ubiquitin. **Figure 28–1** illustrates the three-dimensional structure of ubiquitin. Ubiquitin molecules are attached by **non- α -peptide bonds** formed between the carboxyl terminal of ubiquitin and the ϵ -amino groups of lysyl residues in the target protein (**Figure 28–2**). The residue present at its amino terminus affects whether a protein is ubiquitinated. Amino terminal Met or Ser residues retard, whereas Asp or Arg accelerate ubiquitination. Attachment of a single ubiquitin molecule to transmembrane proteins alters their subcellular localization and targets them for degradation. Soluble proteins undergo **polyubiquitination**, the ligase-catalyzed attachment of four

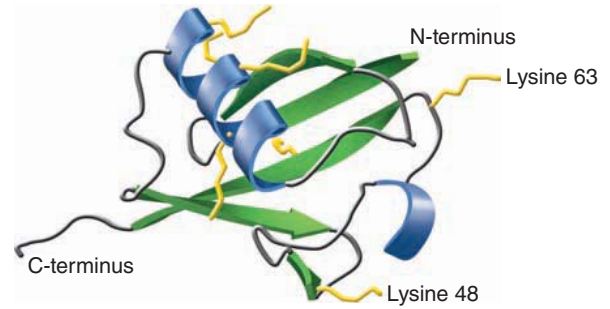

FIGURE 28–1 Three-dimensional structure of ubiquitin. Shown are α -helices (blue), β -strands (green), and the R-groups of lysyl residues (orange). Lys48 & Lys63 are sites for attachment of additional ubiquitin molecules during polyubiquitination. Created by Rogerdodd at Wikipedia using PyMOL, PDB id 1ubi, and crediting the European Bioinformatics Institute.

or more additional ubiquitin molecules at lysyl residues 63 and 68 (**Figure 28–1**). Subsequent degradation of ubiquitin-tagged proteins takes place in the **proteasome**, a macromolecule that also is ubiquitous in eukaryotic cells. The proteasome consists of a macromolecular, cylindrical complex of proteins, whose stacked rings form a central pore that harbors the active sites of proteolytic enzymes. For degradation, a protein thus must first enter the central pore. Entry into the core is regulated by the two outer rings that recognize polyubiquitinated proteins (**Figures 28–3** and **28–4**).

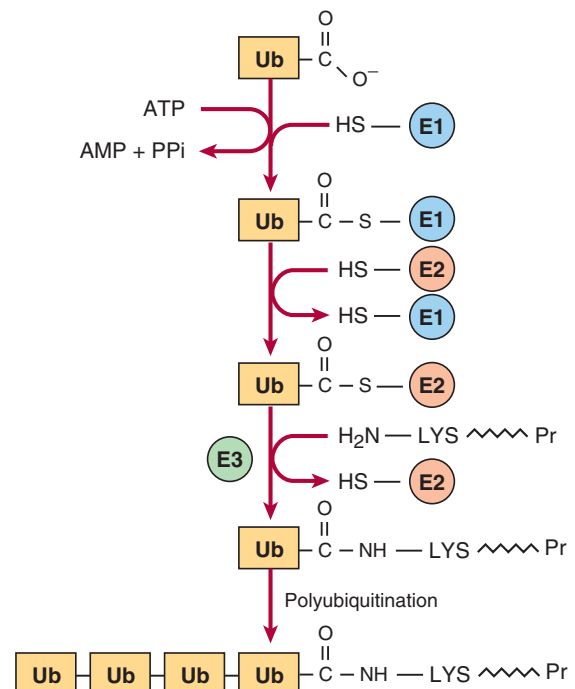

FIGURE 28–2 Reactions involved in the attachment of ubiquitin (Ub) to proteins. Three enzymes are involved. E1 is an activating enzyme, E2 a ligase, and E3 a transferase. While depicted as single entities, there are several types of E1, and over 500 types of E2. The terminal COOH of ubiquitin first forms a thioester. The coupled hydrolysis of PP_i by pyrophosphatase ensures that the reaction will proceed readily. A thioester exchange reaction now transfers activated ubiquitin to E2. E3 then catalyzes the transfer of ubiquitin to the ϵ -amino group of a lysyl residue of the target protein. Additional rounds of ubiquitination result in subsequent polyubiquitination.

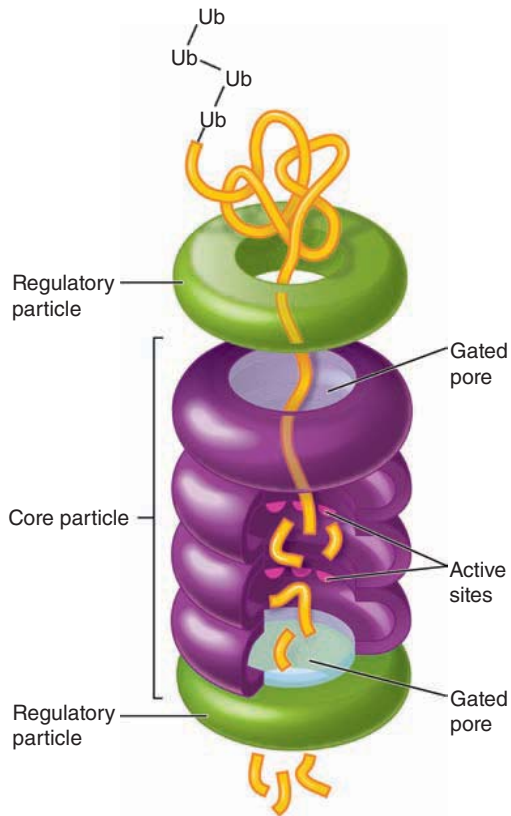

FIGURE 28-3 Representation of the structure of a proteasome. The upper ring is gated to permit only polyubiquitinated proteins to enter the proteasome, where immobilized internal proteases degrade them to peptides.

For the discovery of ubiquitin-mediated protein degradation, Aaron Ciechanover and Avram Hershko of Israel and Irwin Rose of the United States were awarded the 2004 Nobel Prize in Chemistry. Genetic disorders that result from defects

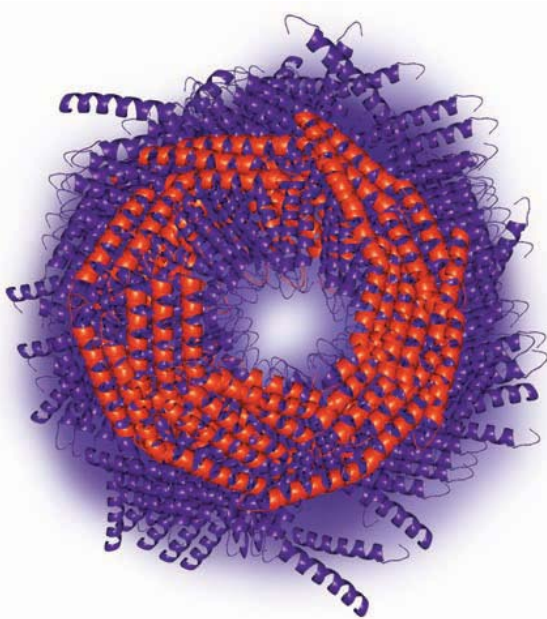

FIGURE 28-4 An end-on view of a proteasome. Created by Rogerdodd at Wikipedia and crediting the European Bioinformatics Institute.

in the genes that encode ubiquitin, ubiquitin ligases, or deubiquitinating enzymes include Angelman syndrome, autosomal recessive juvenile Parkinson's disease, von Hippel-Lindau syndrome, and congenital polycythemia. For additional aspects of protein degradation and of ubiquitination, including its role in the cell cycle, see Chapters 4 and 35.

INTERORGAN EXCHANGE MAINTAINS CIRCULATING LEVELS OF AMINO ACIDS

The maintenance of steady-state concentrations of circulating plasma amino acids between meals depends on the net balance between release from endogenous protein stores and utilization by various tissues. Muscle generates over half of the total body pool of free amino acids, and liver is the site of the urea cycle enzymes necessary for disposal of excess nitrogen. Muscle and liver thus play major roles in maintaining circulating amino acid levels.

Figure 28-5 summarizes the postabsorptive state. Free amino acids, particularly alanine and glutamine, are released from muscle into the circulation. Alanine is extracted primarily by the liver, and glutamine is extracted by the gut and the kidney, both of which convert a significant portion to ammonia. Glutamine also serves as a source of ammonia for excretion by the kidney. The kidney provides a major source of serine for uptake by peripheral tissues, including liver and muscle. Branched-chain amino acids, particularly valine, are released by muscle and taken up predominantly by the brain.

Alanine is a key **gluconeogenic amino acid** (**Figure 28-6**). The rate of hepatic gluconeogenesis from alanine is far higher than from all other amino acids. The capacity of the liver for gluconeogenesis from alanine does not reach saturation until the alanine concentration reaches 20 to 30 times its normal physiologic level. Following a protein-rich meal, the splanchnic tissues release amino acids (**Figure 28-7**) while the peripheral muscles extract amino acids, in both instances predominantly branched-chain amino acids. Branched-chain amino acids thus

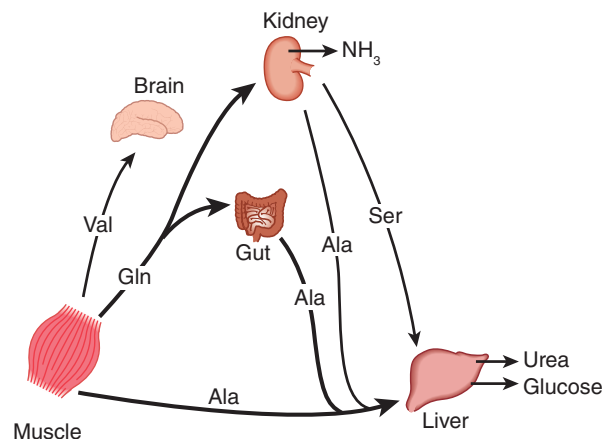

FIGURE 28-5 Interorgan amino acid exchange in normal postabsorptive humans. The key role of alanine in amino acid output from muscle and gut and uptake by the liver is shown.

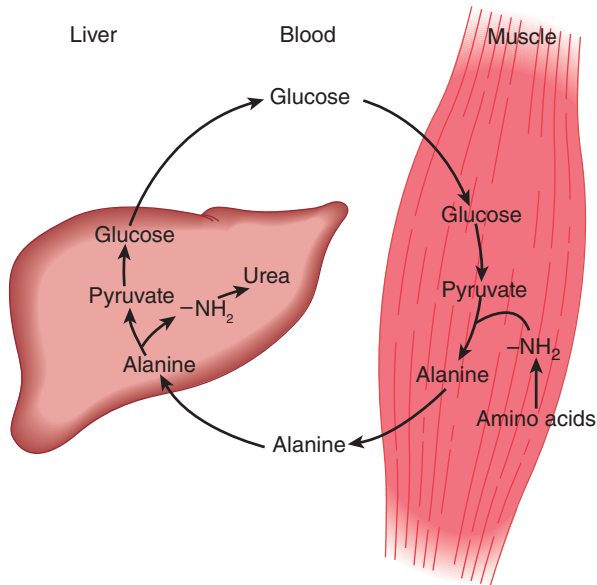

FIGURE 28-6 The glucose-alanine cycle. Alanine is synthesized in muscle by transamination of glucose-derived pyruvate, released into the bloodstream, and taken up by the liver. In the liver, the carbon skeleton of alanine is reconverted to glucose and released into the bloodstream, where it is available for uptake by muscle and resynthesis of alanine.

serve a special role in nitrogen metabolism. In the fasting state they provide the brain with an energy source, and postprandially they are extracted predominantly by muscle, having been spared by the liver.

ANIMALS CONVERT α -AMINO NITROGEN TO VARIED END PRODUCTS

Depending on their ecological niche and physiology, different animals excrete excess nitrogen as ammonia, as uric acid, or as urea. The aqueous environment of teleostean fish, which are **ammonotelic** (excrete ammonia), permits them to excrete

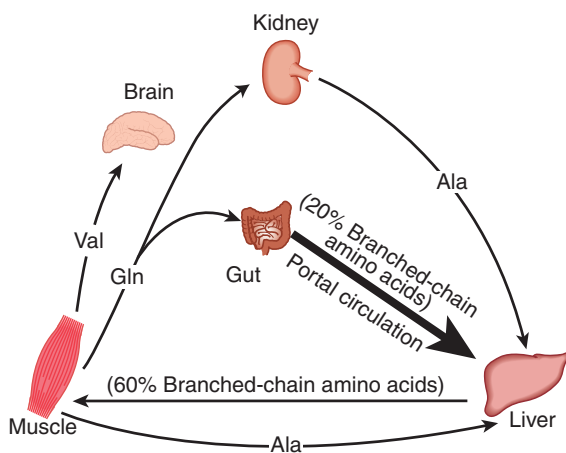

FIGURE 28-7 Summary of amino acid exchange between organs immediately after feeding.

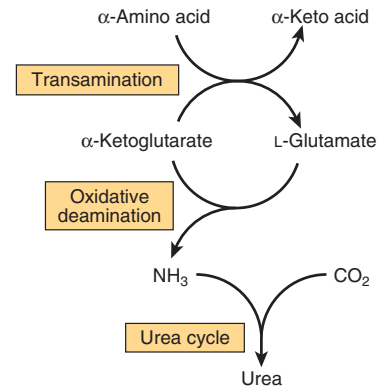

FIGURE 28-8 Overall flow of nitrogen in amino acid catabolism.

water continuously to facilitate excretion of ammonia, which is highly toxic. While this approach is appropriate for an aquatic animal, birds must both conserve water and maintain low weight. Birds, which are **uricotelic**, address both problems by excreting nitrogen-rich uric acid (see Figure 33-11) as semi-solid guano. Many land animals, including humans, are **ureotelic** and excrete nontoxic, highly water-soluble urea. Since urea is nontoxic to humans, high blood levels in renal disease are a consequence, not a cause, of impaired renal function.

BIOSYNTHESIS OF UREA

Urea biosynthesis occurs in four stages: (1) transamination, (2) oxidative deamination of glutamate, (3) ammonia transport, and (4) reactions of the urea cycle (Figure 28-8). The expression in liver of the RNAs for all the enzymes of the urea cycle increases several fold in starvation, probably secondary to enhanced protein degradation to provide energy.

Transamination Transfers α -Amino Nitrogen to α -Ketoglutarate, Forming Glutamate

Transamination reactions interconvert pairs of α -amino acids and α -keto acids (Figure 28-9). Transamination reactions, which are freely reversible, also function in amino acid

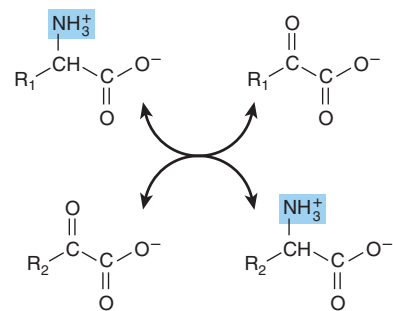

FIGURE 28-9 Transamination. The reaction is freely reversible with an equilibrium constant close to unity.

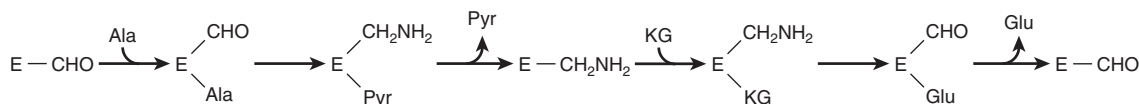

FIGURE 28–10 “Ping-pong” mechanism for transamination. E—CHO and E—CH₂NH₂ represent enzyme-bound pyridoxal phosphate and pyridoxamine phosphate, respectively. (Ala, alanine; Glu, glutamate; KG, α -ketoglutarate; Pyr, pyruvate.)

biosynthesis (see Figure 27–4). All of the common amino acids except lysine, threonine, proline, and hydroxyproline participate in transamination. Transamination is not restricted to α -amino groups. The δ -amino group of ornithine (but not the ϵ -amino group of lysine) readily undergoes transamination.

Alanine-pyruvate aminotransferase (alanine aminotransferase, EC 2.6.1.2) and glutamate- α -ketoglutarate aminotransferase (glutamate aminotransferase, EC 2.6.1.1) catalyze the transfer of amino groups to pyruvate (forming alanine) or to α -ketoglutarate (forming glutamate).

Each aminotransferase is specific for one pair of substrates, but nonspecific for the other pair. Since alanine is also a substrate for glutamate aminotransferase, the α -amino nitrogen from all amino acids that undergo transamination can be concentrated in glutamate. This is important because L-glutamate is the only amino acid that undergoes oxidative deamination at an appreciable rate in mammalian tissues. The formation of ammonia from α -amino groups thus occurs mainly via the α -amino nitrogen of L-glutamate.

Transamination occurs via a “ping-pong” mechanism characterized by the alternate addition of a substrate and release of a product (Figure 28–10). Following removal of its α -amino nitrogen by transamination, the remaining carbon “skeleton” of an amino acid is degraded by pathways discussed in Chapter 29.

Pyridoxal phosphate (PLP), a derivative of vitamin B₆, is present at the catalytic site of all aminotransferases, and plays a key role in catalysis. During transamination, PLP serves as a “carrier” of amino groups. An enzyme-bound Schiff base (Figure 28–11) is formed between the oxo group of enzyme-bound PLP and the α -amino group of an α -amino acid. The Schiff base can rearrange in various ways. In transamination, rearrangement forms an α -keto acid and enzyme-bound pyridoxamine phosphate. As noted earlier, certain diseases are associated with elevated serum levels of aminotransferases (see Table 7–2).

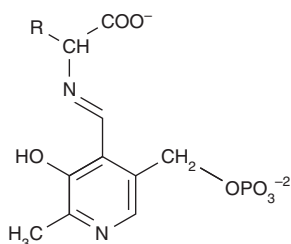

FIGURE 28–11 Structure of a Schiff base formed between pyridoxal phosphate and an amino acid.

L-GLUTAMATE DEHYDROGENASE OCCUPIES A CENTRAL POSITION IN NITROGEN METABOLISM

Transfer of amino nitrogen to α -ketoglutarate forms L-glutamate. Hepatic L-glutamate dehydrogenase (GDH), which can use either NAD⁺ or NADP⁺, releases this nitrogen as ammonia (Figure 28–12). Conversion of α -amino nitrogen to ammonia by the concerted action of glutamate aminotransferase and GDH is often termed “transdeamination.” Liver GDH activity is allosterically inhibited by ATP, GTP, and NADH, and is activated by ADP. The GDH reaction is freely reversible, and also functions in amino acid biosynthesis (see Figure 27–1).

AMINO ACID OXIDASES REMOVE NITROGEN AS AMMONIA

L-Amino acid oxidase of liver and kidney convert an amino acid to an α -imino acid that decomposes to an α -keto acid with release of ammonium ion (Figure 28–13). The reduced flavin is reoxidized by molecular oxygen, forming hydrogen peroxide (H₂O₂), which then is split to O₂ and H₂O by catalase, EC 1.11.1.6.

Ammonia Intoxication Is Life Threatening

The ammonia produced by enteric bacteria and absorbed into portal venous blood and the ammonia produced by tissues are rapidly removed from circulation by the liver and converted to urea. Thus, only traces (10–20 μ g/dL) normally are present in peripheral blood. This is essential, since ammonia is toxic to the central nervous system. Should portal blood bypass the liver, systemic blood ammonia may attain toxic levels. This occurs in severely impaired hepatic function or

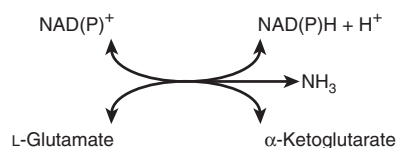

FIGURE 28–12 The reaction catalyzed by glutamate dehydrogenase, EC 1.4.1.2. NAD(P)⁺ means that either NAD⁺ or NADP⁺ can serve as the oxidoreductant. The reaction is reversible, but strongly favors glutamate formation.

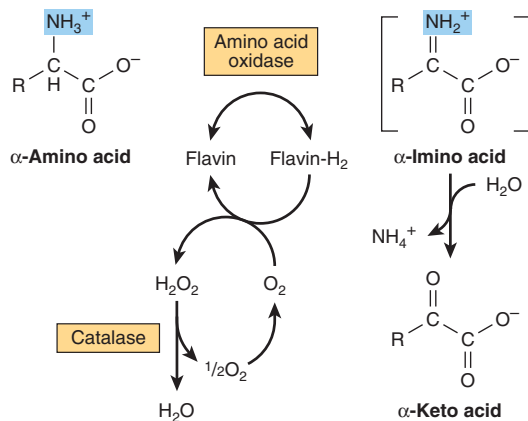

FIGURE 28-13 Oxidative deamination catalyzed by L-amino acid oxidase (L- α -amino acid:O₂ oxidoreductase, EC 1.4.3.2). The α -imino acid, shown in brackets, is not a stable intermediate.

the development of collateral links between the portal and systemic veins in cirrhosis. Symptoms of **ammonia intoxication** include tremor, slurred speech, blurred vision, coma, and ultimately death. Ammonia may be toxic to the brain in part because it reacts with α -ketoglutarate to form glutamate. The resulting depletion of levels of α -ketoglutarate then impairs function of the tricarboxylic acid (TCA) cycle in neurons.

Glutamine Synthase Fixes Ammonia as Glutamine

Formation of glutamine is catalyzed by mitochondrial **glutamine synthase** (Figure 28-14). Since amide bond synthesis is coupled to the hydrolysis of ATP to ADP and P_i, the reaction strongly favors glutamine synthesis. During catalysis, glutamate attacks the γ -phosphoryl group of ATP, forming γ -glutamyl phosphate and ADP. Following deprotonation of NH₄⁺, NH₃ attacks γ -glutamyl phosphate, and glutamine and P_i are released. In addition to providing glutamine to serve as a carrier of nitrogen, carbon and energy between organs (Figure 28-5), glutamine synthase plays a major role in ammonia

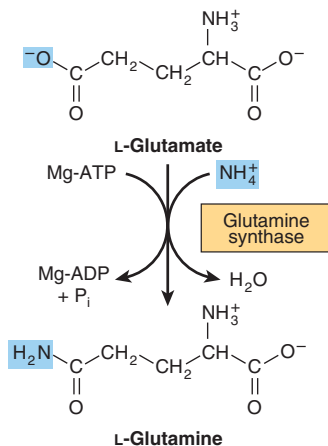

FIGURE 28-14 Formation of glutamine, catalyzed by glutamine synthase, EC 6.3.1.2.

detoxification and acid-base homeostasis. A rare deficiency in neonate glutamine synthase results in severe brain damage, multiorgan failure, and death.

Glutaminase & Asparaginase Deamidate Glutamine & Asparagine

There are two human isoforms of mitochondrial **glutaminase**, termed liver-type and renal-type glutaminase. Products of different genes, the glutaminases differ with respect to their structure, kinetics, and regulation. Hepatic glutaminase levels rise in response to high protein intake while renal kidney-type glutaminase increases in metabolic acidosis. Hydrolytic release of the amide nitrogen of glutamine as ammonia, catalyzed by glutaminase (Figure 28-15), strongly favors glutamate formation. An analogous reaction is catalyzed by L-asparaginase (EC 3.5.1.1). The concerted action of glutamine synthase and glutaminase thus catalyzes the interconversion of free ammonium ion and glutamine.

Formation & Secretion of Ammonia Maintains Acid-Base Balance

Excretion into urine of ammonia produced by renal tubular cells facilitates cation conservation and regulation of acid-base balance. Ammonia production from intracellular renal amino acids, especially glutamine, increases in **metabolic acidosis** and decreases in **metabolic alkalosis**.

Urea is the Major End Product of Nitrogen Catabolism in Humans

Synthesis of 1 mol of urea requires 3 mol of ATP, 1 mol each of ammonium ion and of aspartate, and employs five enzymes (Figure 28-16). Of the six participating amino acids, *N*-acetylglutamate functions solely as an enzyme activator. The others serve as carriers of the atoms that ultimately become urea. The major metabolic role of **ornithine, citrulline,**

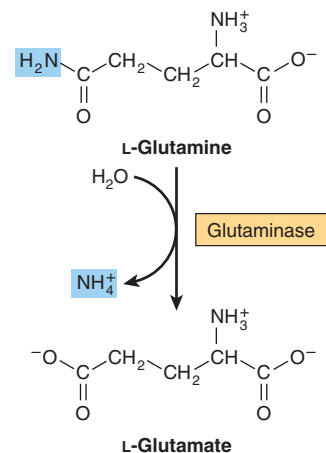

FIGURE 28-15 The reaction catalyzed by glutaminase, EC 3.5.1.2. The reaction proceeds essentially irreversibly in the direction of glutamate and NH₄⁺ formation. Note that the *amide* nitrogen, not the α -amino nitrogen, is removed.

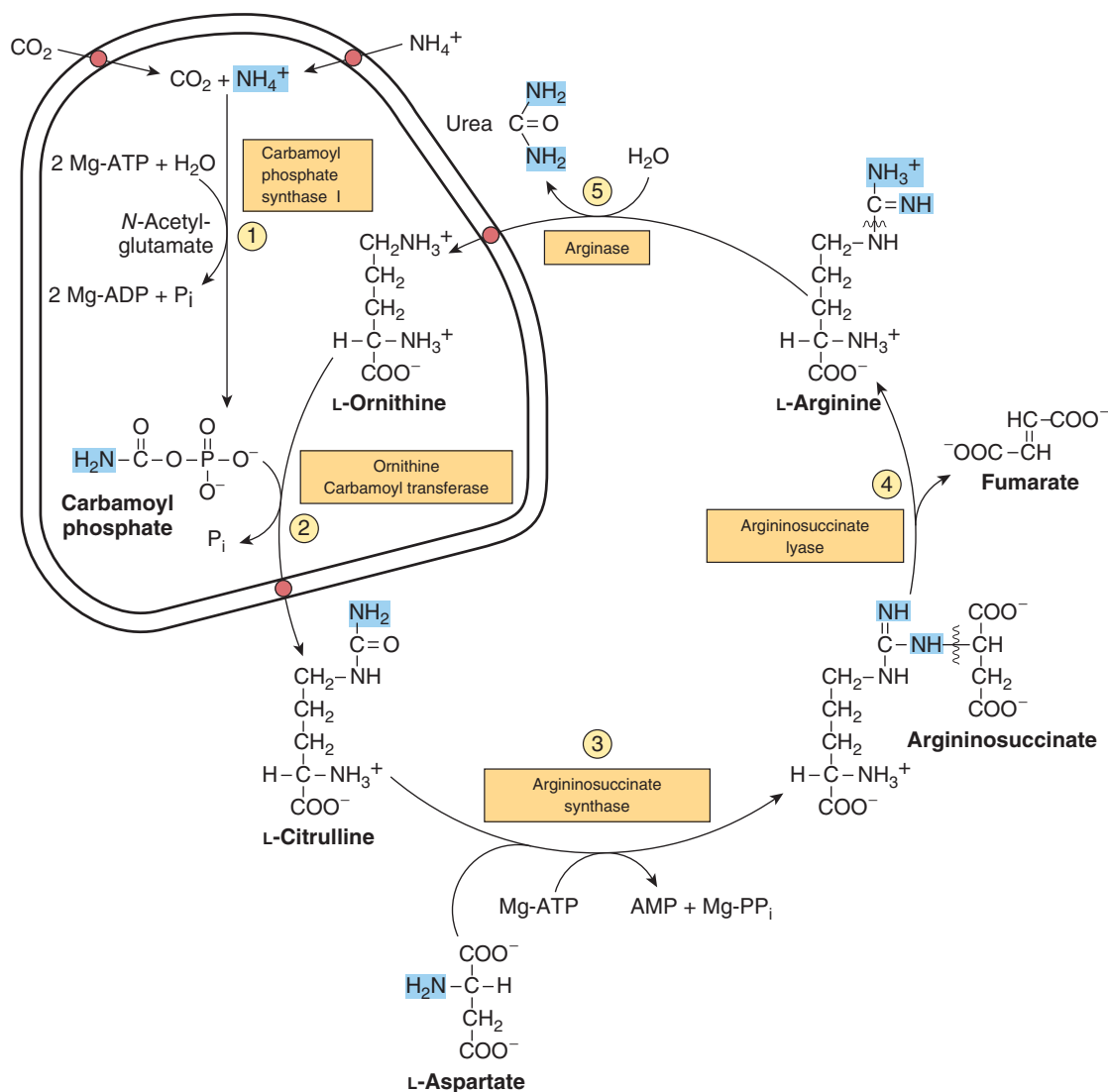

FIGURE 28-16 Reactions and intermediates of urea biosynthesis. The nitrogen-containing groups that contribute to the formation of urea are shaded. Reactions ① and ② occur in the matrix of liver mitochondria and reactions ③, ④, and ⑤ in liver cytosol. CO_2 (as bicarbonate), ammonium ion, ornithine, and citrulline enter the mitochondrial matrix via specific carriers (see red dots) present in the inner membrane of liver mitochondria.

and **argininosuccinate** in mammals is urea synthesis. Urea synthesis is a cyclic process. While ammonium ion, CO_2 , ATP, and aspartate are consumed, the ornithine consumed in reaction 2 is regenerated in reaction 5. There thus is no net loss or gain of ornithine, citrulline, argininosuccinate, or arginine. As indicated in Figure 28-16, some reactions of urea synthesis occur in the matrix of the mitochondrion, and other reactions in the cytosol.

Carbamoyl Phosphate Synthase I Initiates Urea Biosynthesis

Condensation of CO_2 , ammonia, and ATP to form **carbamoyl phosphate** is catalyzed by mitochondrial **carbamoyl phosphate synthase I** (EC 6.3.4.16). A cytosolic form of this enzyme, carbamoyl phosphate synthase II, uses glutamine rather than ammonia as the nitrogen donor and functions in pyrimidine biosynthesis (see Figure 33-9). The concerted

action of glutamate dehydrogenase and carbamoyl phosphate synthase 1 thus shuttles amino nitrogen into carbamoyl phosphate, a compound with high group transfer potential.

Carbamoyl phosphate synthase I, the rate-limiting enzyme of the urea cycle, is active only in the presence of **N-acetylglutamate**, an allosteric activator that enhances the affinity of the synthase for ATP. Synthesis of 1 mol of carbamoyl phosphate requires 2 mol of ATP. One ATP serves as the phosphoryl donor for formation of the mixed acid anhydride bond of carbamoyl phosphate. The second ATP provides the driving force for synthesis of the amide bond of carbamoyl phosphate. The other products are 2 mol of ADP and 1 mol of P_i (reaction 1, Figure 28-16). The reaction proceeds stepwise. Reaction of bicarbonate with ATP forms carbonyl phosphate and ADP. Ammonia then displaces ADP, forming carbamate and orthophosphate. Phosphorylation of carbamate by the second ATP then forms carbamoyl phosphate.

Carbamoyl Phosphate Plus Ornithine Forms Citrulline

L-Ornithine transcarbamoylase (EC 2.1.3.3) catalyzes transfer of the carbamoyl group of carbamoyl phosphate to ornithine, forming citrulline and orthophosphate (reaction 2, Figure 28–16). While the reaction occurs in the mitochondrial matrix, both the formation of ornithine and the subsequent metabolism of citrulline take place in the cytosol. Entry of ornithine into mitochondria and exodus of citrulline from mitochondria therefore involve mitochondrial inner membrane permeases (Figure 28–16).

Citrulline Plus Aspartate Forms Argininosuccinate

Argininosuccinate synthase (EC 6.3.4.5) links aspartate and citrulline via the amino group of aspartate (reaction 3, Figure 28–16) and provides the second nitrogen of urea. The reaction requires ATP and involves intermediate formation of citrullyl-AMP. Subsequent displacement of AMP by aspartate then forms argininosuccinate.

Cleavage of Argininosuccinate Forms Arginine & Fumarate

Cleavage of argininosuccinate is catalyzed by **argininosuccinate lyase** (EC 4.3.2.1). The reaction proceeds with retention of all three nitrogens in arginine and release of the aspartate skeleton as fumarate (reaction 4, Figure 28–16). Subsequent addition of water to fumarate forms L-malate, whose subsequent NAD⁺-dependent oxidation forms oxaloacetate. These two reactions are analogous to reactions of the citric acid cycle, but are catalyzed by **cytosolic fumarase and malate dehydrogenase**. Transamination of oxaloacetate by glutamate aminotransferase then re-forms aspartate. The carbon skeleton of aspartate-fumarate thus acts as a carrier of the nitrogen of glutamate into a precursor of urea.

Cleavage of Arginine Releases Urea & Re-Forms Ornithine

Hydrolytic cleavage of the guanidino group of arginine, catalyzed by liver **arginase** (EC 3.5.3.1), releases urea (reaction 5, Figure 28–16). The other product, ornithine, reenters liver mitochondria and participates in additional rounds of urea synthesis. Ornithine and lysine are potent inhibitors of arginase, and compete with arginine. Arginine also serves as the precursor of the potent muscle relaxant nitric oxide (NO) in a Ca²⁺-dependent reaction catalyzed by NO synthase.

Carbamoyl Phosphate Synthase I Is the Pacemaker Enzyme of the Urea Cycle

The activity of carbamoyl phosphate synthase I is determined by **N-acetylglutamate**, whose steady-state level is dictated by the balance between its rate of synthesis from acetyl-CoA and glutamate and its rate of hydrolysis to acetate

and glutamate, reactions catalyzed by **N-acetylglutamate synthase (NAGS)** and **N-acetylglutamate deacylase** (hydrolyase), respectively.

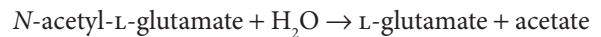
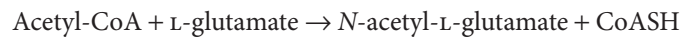

Major changes in diet can increase the concentrations of individual urea cycle enzymes 10- to 20-fold. For example, starvation elevates enzyme levels, presumably to cope with the increased production of ammonia that accompanies enhanced starvation-induced degradation of protein.

GENERAL FEATURES OF METABOLIC DISORDERS

The comparatively rare, but well-characterized and medically devastating metabolic disorders associated with the enzymes of urea biosynthesis illustrate the following general principles of inherited metabolic diseases.

1. Similar or identical clinical signs and symptoms can accompany various genetic mutations in a gene that encodes a given enzyme or in enzymes that catalyze successive reactions in a metabolic pathway.
2. Rational therapy is based on an understanding of the relevant biochemical enzyme-catalyzed reactions in both normal and impaired individuals.
3. The identification of intermediates and of ancillary products that accumulate prior to a metabolic block provides the basis for metabolic screening tests that can implicate the reaction that is impaired.
4. Definitive diagnosis involves quantitative assay of the activity of the enzyme suspected to be defective.
5. The DNA sequence of the gene that encodes a given mutant enzyme is compared to that of the wild-type gene to identify the specific mutation(s) that cause the disease.
6. The exponential increase in DNA sequencing of human genes has identified dozens of mutations of an affected gene that are benign or are associated with symptoms of varying severity of a given metabolic disorder.

METABOLIC DISORDERS ARE ASSOCIATED WITH EACH REACTION OF THE UREA CYCLE

Defects in each enzyme of the urea cycle have been described. Many of the causative mutations have been mapped, and specific defects in the encoded enzymes have been identified. Five well-documented diseases represent defects in the biosynthesis of enzymes of the urea cycle. Molecular genetic analysis has pinpointed the loci of mutations associated with each deficiency, each of which exhibits considerable genetic and phenotypic variability (**Table 28–1**).

TABLE 28-1 Enzymes of Inherited Metabolic Disorders of the Urea Cycle

Enzyme	Enzyme Catalog Number	OMIM ^a Reference	Figure and Reaction
Carbamoyl-phosphate synthase I	6.3.4.16	237300	28-13①
Ornithine carbamoyl transferase	2.1.3.3	311250	28-13②
Argininosuccinate synthase	6.3.4.5	215700	28-13③
Argininosuccinate lyase	4.3.2.1	608310	28-13④
Arginase	3.5.3.1	608313	28-13⑤

^aOnline Mendelian inheritance in man database: ncbi.nlm.nih.gov/omim/

Urea cycle disorders are characterized by hyperammonemia, encephalopathy, and respiratory alkalosis. Four of the five metabolic diseases, deficiencies of carbamoyl phosphate synthase I, ornithine carbamoyl transferase, argininosuccinate synthase, and argininosuccinate lyase, result in the accumulation of precursors of urea, principally ammonia and glutamine. Ammonia intoxication is most severe when the metabolic block occurs at reactions 1 or 2 (Figure 28–16), for if citrulline can be synthesized, some ammonia has already been removed by being covalently linked to an organic metabolite.

Clinical symptoms common to all urea cycle disorders include vomiting, avoidance of high-protein foods, intermittent ataxia, irritability, lethargy, and severe mental retardation. The most dramatic clinical presentation occurs in full-term infants who initially appear normal, then exhibit progressive lethargy, hypothermia, and apnea due to high plasma ammonia levels. The clinical features and treatment of all five disorders are similar. Significant improvement and minimization of brain damage can accompany a low-protein diet ingested as frequent small meals to avoid sudden increases in blood ammonia levels. The goal of dietary therapy is to provide sufficient protein, arginine, and energy to promote growth and development while simultaneously minimizing the metabolic perturbations.

Carbamoyl Phosphate Synthase I

N-Acetylglutamate is essential for the activity of carbamoyl phosphate synthase I, EC 6.3.4.16 (reaction 1, Figure 28–16). Defects in carbamoyl phosphate synthase I are responsible for the relatively rare (estimated frequency 1:62,000) metabolic disease termed “hyperammonemia type 1.”

N-Acetylglutamate Synthase

N-Acetylglutamate synthase, EC 2.3.1.1 (NAGS), catalyzes the formation from acetyl-CoA and glutamate of the *N*-acetylglutamate essential for carbamoyl phosphate synthase I activity.

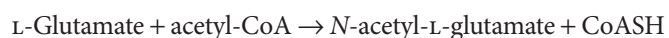

While the clinical and biochemical features of NAGS deficiency are indistinguishable from those arising from a defect in carbamoyl phosphate synthase I, a deficiency in NAGS may respond to administered *N*-acetylglutamate.

Ornithine Permease

The hyperornithinemia, hyperammonemia, and homocitrullinuria syndrome (**HHH syndrome**) results from mutation of the *ORNT1* gene that encodes the mitochondrial membrane ornithine permease. The failure to import cytosolic ornithine into the mitochondrial matrix renders the urea cycle inoperable, with consequent hyperammonemia, and hyperornithinemia due to the accompanying accumulation of cytosolic ornithine. In the absence of its normal acceptor (ornithine), mitochondrial carbamoyl phosphate carbamoylates lysine to homocitrulline, resulting in homocitrullinuria.

Ornithine Transcarbamoylase

The X-chromosome linked deficiency termed “hyperammonemia type 2” reflects a defect in ornithine transcarbamoylase (reaction 2, Figure 28–16). The mothers also exhibit hyperammonemia and an aversion to high-protein foods. Levels of glutamine are elevated in blood, cerebrospinal fluid, and urine, probably as a result of enhanced glutamine synthesis in response to elevated levels of tissue ammonia.

Argininosuccinate Synthase

In addition to patients who lack detectable argininosuccinate synthase activity (reaction 3, Figure 28–16), a 25-fold elevated K_m for citrulline has been reported. In the resulting citrullinemia, plasma and cerebrospinal fluid citrulline levels are elevated, and 1 to 2 g of citrulline are excreted daily.

Argininosuccinate Lyase

Argininosuccinic aciduria, accompanied by elevated levels of argininosuccinate in blood, cerebrospinal fluid, and urine, is associated with friable, tufted hair (trichorrhexis nodosa). Both early- and late-onset types are known. The metabolic defect is in argininosuccinate lyase (reaction 4, Figure 28–16). Diagnosis by the measurement of erythrocyte argininosuccinate lyase activity can be performed on umbilical cord blood or amniotic fluid cells.

Arginase

Hyperargininemia is an autosomal recessive defect in the gene for arginase (reaction 5, Figure 28–16). Unlike other urea cycle disorders, the first symptoms of hyperargininemia typically do not appear until age 2 to 4 years. Blood and cerebrospinal fluid

levels of arginine are elevated. The urinary amino acid pattern, which resembles that of lysine-cystinuria (see Chapter 29), may reflect competition by arginine with lysine and cysteine for reabsorption in the renal tubule.

Analysis of Neonate Blood by Tandem Mass Spectrometry Can Detect Metabolic Diseases

Metabolic diseases caused by the absence or functional impairment of metabolic enzymes can be devastating. Early dietary intervention, however, can in many instances ameliorate the otherwise inevitable dire effects. The early detection of such metabolic diseases is thus of primary importance. Since the initiation in the United States of newborn screening programs in the 1960s, all states now conduct metabolic screening of newborns, although the scope of screen employed varies among states. The powerful and sensitive technique of **tandem mass spectrometry** (see Chapter 4) can in a few minutes detect over 40 analytes of significance in the detection of metabolic disorders. Most states employ tandem MS to screen newborns to detect metabolic disorders such as organic acidemias, aminoacidemias, disorders of fatty acid oxidation, and defects in the enzymes of the urea cycle. An article in *Clinical Chemistry* 2006 39:315 reviews the theory of tandem MS, its application to the detection of metabolic disorders, and situations that can yield false positives, and includes a lengthy table of detectable analytes and the relevant metabolic diseases.

Can Gene Therapy Offer Promise for Correcting Defects in Urea Biosynthesis?

Gene therapy of defects in the enzymes of the urea cycle is an area of active investigation. Despite encouraging results in animal models using an adenoviral vector to treat citrullinemia, at present gene therapy provides no effective solution for human subjects.

SUMMARY

- Human subjects degrade 1% to 2% of their body protein daily at rates that vary widely between proteins and with physiologic state. Key regulatory enzymes often have short half-lives.
- Proteins are degraded by both ATP-dependent and ATP-independent pathways. Ubiquitin targets many intracellular proteins for degradation. Liver cell surface receptors bind and internalize circulating asialoglycoproteins destined for lysosomal degradation.
- Polyubiquitinated proteins are degraded by proteases on the inner surface of a cylindrical macromolecule, the proteasome. Entry into the proteasome is gated by a donut-shaped protein pore that rejects entry to all but polyubiquitinated proteins.
- Fish excrete highly toxic NH_3 directly. Birds convert NH_3 to uric acid. Higher vertebrates convert NH_3 to urea.
- Transamination channels amino acid nitrogen into glutamate. GDH occupies a central position in nitrogen metabolism.
- Glutamine synthase converts NH_3 to nontoxic glutamine. Glutaminase releases NH_3 for use in urea synthesis.
- NH_3 , CO_2 , and the amide nitrogen of aspartate provide the atoms of urea.
- Hepatic urea synthesis takes place in part in the mitochondrial matrix and in part in the cytosol.
- Changes in enzyme levels and allosteric regulation of carbamoyl phosphate synthase I by *N*-acetylglutamate regulate urea biosynthesis.
- Metabolic diseases are associated with defects in each enzyme of the urea cycle, of the membrane-associated ornithine permease, and of NAGS.
- The metabolic disorders of urea biosynthesis illustrate six general principles of all metabolic disorders.
- Tandem mass spectrometry is the technique of choice for screening neonates for inherited metabolic diseases.

REFERENCES

- Adam S, Almeida MF, Assoun M et al: Dietary management of urea cycle disorders: European practice. *Mol Genet Metab* 2013;110:439.
- Caldovic L, Morizono H, Tuchman M: Mutations and polymorphisms in the human *N*-acetylglutamate synthase (NAGS) gene. *Hum Mutat* 2007;28:754.
- Crombez EA, Cederbaum SD: Hyperargininemia due to liver arginase deficiency. *Mol Genet Metab* 2005;84:243.
- Elpeleg O, Shaag A, Ben-Shalom E, et al: *N*-acetylglutamate synthase deficiency and the treatment of hyperammonemic encephalopathy. *Ann Neurol* 2002;52:845.
- Garg U, Dasouki M: Expanded newborn screening of inherited metabolic disorders by tandem mass spectrometry. Clinical and laboratory aspects. *Clin Biochem* 2006;39:315.
- Gyato K, Wray J, Huang ZJ, et al: Metabolic and neuropsychological phenotype in women heterozygous for ornithine transcarbamylase deficiency. *Ann Neurol* 2004;55:80.
- Häberle J, Görg B, Rutsch F, et al: Congenital glutamine deficiency with glutamine synthetase mutations. *N Engl J Med* 2005;353:1926.
- Häberle J, Pauli S, Schmidt E, et al: Mild citrullinemia in caucasians is an allelic variant of argininosuccinate synthetase deficiency (citrullinemia type 1). *Mol Genet Metab* 2003;80:302.
- Jiang YH, Beaudet AL: Human disorders of ubiquitination and proteasomal degradation. *Curr Opin Pediatr* 2004;16:419.
- Pal A, Young MA, Donato NJ: Emerging potential of therapeutic targeting of ubiquitin-specific proteases in the treatment of cancer. *Cancer Res* 2014;74:721.
- Pickart CM: Mechanisms underlying ubiquitination. *Annu Rev Biochem* 2001;70:503.
- Scriver CR: Garrod's foresight; our hindsight. *J Inher Metab Dis* 2001;24:93.
- Scriver CR, Sly WS, Childs B, et al (editors): *The Metabolic and Molecular Bases of Inherited Disease*, 8th ed. McGraw-Hill, 2001.
- Sylvestersen KB, Young C, Nielsen ML: Advances in characterizing ubiquitylation sites by mass spectrometry. *Curr Opin Chem Biol* 2013;17:49.
- Yi JJ, Ehlers MD: Emerging roles for ubiquitin and protein degradation in neuronal function. *Pharmacol Rev* 2007;59:206.

Catabolism of the Carbon Skeletons of Amino Acids

Victor W. Rodwell, PhD

OBJECTIVES

After studying this chapter, you should be able to:

- Name the principal catabolites of the carbon skeletons of the protein amino acids and the major metabolic fates of these catabolites.
- Write an equation for an aminotransferase (transaminase) reaction and illustrate the role played by the coenzyme.
- Outline the metabolic pathways for each of the protein amino acids, and identify reactions associated with clinically significant metabolic disorders.
- Provide examples of aminoacidurias that arise from defects in glomerular tubular reabsorption, and the consequences of impaired intestinal absorption of tryptophan.
- Explain why metabolic defects in different enzymes of the catabolism of a specific amino acid can be associated with similar clinical signs and symptoms.
- Describe the implications of a metabolic defect in Δ^1 -pyrroline-5-carboxylate dehydrogenase for the catabolism of proline and of 4-hydroxyproline.
- Explain how the α -amino nitrogen of proline and of lysine is removed by processes other than transamination.
- Draw analogies between the reactions that participate in the catabolism of fatty acids and of the branched-chain amino acids.
- Identify the specific metabolic defects in hypervalinemia, maple syrup urine disease, intermittent branched-chain ketonuria, isovaleric acidemia, and methylmalonic aciduria.

BIOMEDICAL IMPORTANCE

Chapter 28 described the removal by transamination and the metabolic fate of the nitrogen atoms of most of the protein L- α -amino acids. This chapter addresses the metabolic fates of the resulting hydrocarbon skeletons of each of the protein amino acids. The topics include the enzymes, the intermediates formed during the catabolism of the carbon skeletons to amphibolic intermediates, and several associated metabolic diseases or “inborn errors of metabolism.” Most disorders of amino acid catabolism are rare, but if left untreated they can result in irreversible brain damage and early mortality. Prenatal or early postnatal detection of metabolic disorders and timely initiation of treatment thus are essential. The ability to detect

the activities of enzymes in cultured amniotic fluid cells facilitates prenatal diagnosis by amniocentesis. All states now conduct screening tests of newborns for as up to 40 metabolic diseases. These tests include, but are not limited to, disorders associated with defects in the catabolism of amino acids. The most reliable screening tests use tandem mass spectrometry to detect, in a few drops of neonate blood, catabolites suggestive of a given metabolic defect. The metabolites detected pinpoint the metabolic defect as the lowered or absent activity of a given enzyme. Treatment consists primarily of feeding diets low in the amino acid whose catabolism is impaired.

Mutations either of a gene or of associated regulatory regions of DNA can result either in the failure to synthesize the encoded enzyme or in synthesis of a partially or

completely nonfunctional enzyme. While some mutations do not adversely affect enzyme activity, mutations that compromise an enzyme's three-dimensional structure, or that disrupt catalytic or regulatory sites of an enzyme, can have severe metabolic consequences. Low catalytic efficiency of a mutant enzyme can result from impaired positioning of residues involved in catalysis, or in binding a substrate, coenzyme, or metal ion. Mutations may also impair the ability of certain enzymes to respond appropriately to the signals that modulate their activity by altering an enzyme's affinity for an allosteric regulator of activity. Since different mutations can have similar effects on any of the above factors, various mutations may give rise to the same clinical signs and symptoms. At a molecular level, these therefore are distinct molecular diseases. To supplement the disorders of amino acid metabolism discussed in this chapter, readers should consult major reference works on this topic such as Scriver et al. 2001.

AMINO ACIDS ARE CATABOLIZED TO INTERMEDIATES FOR CARBOHYDRATE AND LIPID BIOSYNTHESIS

Nutritional studies in the period 1920 to 1940, reinforced and confirmed by studies using isotopically labeled amino acids conducted from 1940 to 1950, established the interconvertibility of the carbon atoms of fat, carbohydrate, and protein. These studies also revealed that all or a portion of the carbon skeleton of every amino acid is convertible either to carbohydrate (13 amino acids), fat (one amino acid), or both fat and carbohydrate (five amino acids) (Table 29-1). Figure 29-1 outlines overall aspects of these interconversions.

TABLE 29-1 Fate of the Carbon Skeletons of the Protein L- α -Amino Acids

Converted to Amphibolic Intermediates That Form			
Carbohydrate (Glycogenic)	Fat (Ketogenic)		Glycogen and Fat (Glycogenic and Ketogenic)
Ala	Hyp	Leu	Ile
Arg	Met		Lys
Asp	Pro		Phe
Cys	Ser		Trp
Glu	Thr		Tyr
Gly	Val		
His			

TRANSAMINATION TYPICALLY INITIATES AMINO ACID CATABOLISM

Removal of α -amino nitrogen by transamination, catalyzed by an aminotransferase (a transaminase; see Figure 28-9), is the first catabolic reaction of most of the protein amino acids. The exceptions are proline, hydroxyproline, threonine, and lysine, whose α -amino groups do not participate in transamination. The hydrocarbon skeletons that remain are then degraded to amphibolic intermediates as outlined in Figure 29-1.

Asparagine & Aspartate Form Oxaloacetate

All four carbons of asparagine and of aspartate form **oxaloacetate** via reactions catalyzed by **asparaginase** (EC 3.5.1.1)

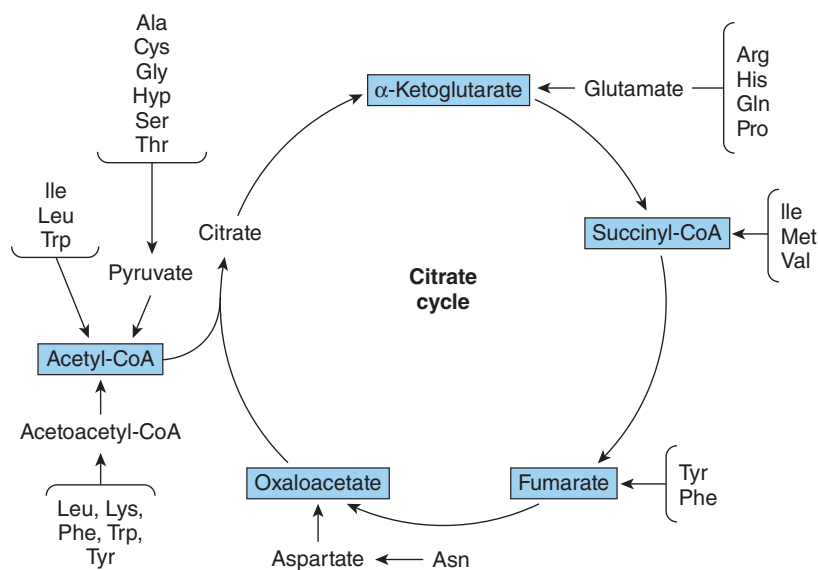

FIGURE 29-1 Overview of the amphibolic intermediates that result from catabolism of the protein amino acids.

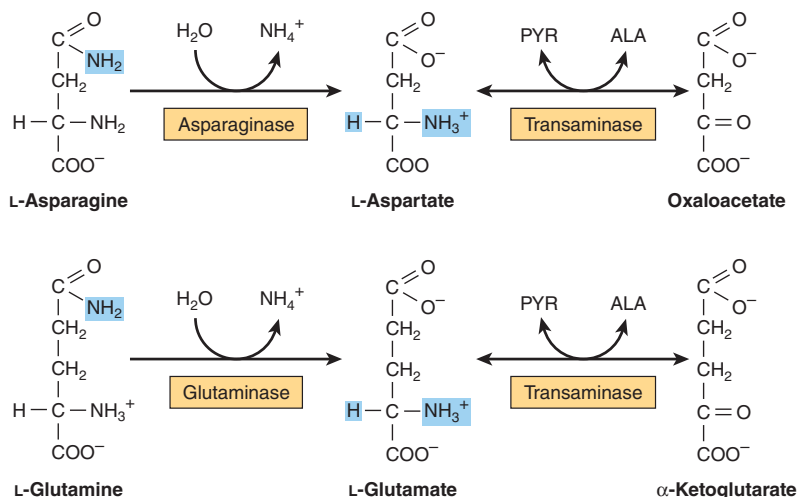

FIGURE 29-2 Catabolism to amphibolic intermediates of L-asparagine (top) and of L-glutamine (bottom). (ALA, L-alanine; PYR, pyruvate.) In this and subsequent figures, blue highlights emphasize the portions of the molecules that are undergoing chemical change.

and a **transaminase** (Figure 29-2, top). Metabolic defects in transaminases, which fulfill central amphibolic functions, may be incompatible with life. Consequently, no known metabolic defect is associated with this short catabolic pathway.

Glutamine & Glutamate Form α-Ketoglutarate

The catabolism of glutamine and of glutamate parallels that of asparagine and aspartate in reactions catalyzed by **glutaminase** (EC 3.5.1.2) and a **transaminase** that forms **α-ketoglutarate** (Figure 29-2, bottom). While both glutamate and aspartate are substrates for the same transaminase, deamidation of their corresponding amides is catalyzed by different enzymes, asparaginase, and glutaminase. Possibly for the reason stated earlier, there are no known metabolic defects of the glutamine-glutamate catabolic pathway.

Significant metabolic disorders are, however, associated with the catabolism of many other amino acids. These metabolic disorders are discussed below under the catabolism of each amino acid, and are summarized in **Table 29-2**. This table lists the impaired enzyme, its IUB enzyme catalog (EC) number, a cross-reference to a specific figure and numbered reaction in this text, and a numerical link to the Online Mendelian Inheritance in Man database (**OMIM**).

Proline

The catabolism of proline takes place in mitochondria. Since proline does not participate in transamination, its α-amino nitrogen is retained throughout a two-stage oxidation to glutamate. Oxidation to Δ¹-pyrroline-5-carboxylate is catalyzed by proline dehydrogenase, EC 1.5.99.8. Subsequent oxidation to glutamate is catalyzed by Δ¹-pyrroline-5-carboxylate dehydrogenase (also called glutamate-γ-semialdehyde dehydrogenase, EC 1.5.1.12) (**Figure 29-3**). There are two metabolic disorders of proline catabolism. Inherited as autosomal recessive traits,

both are consistent with a normal adult life. The metabolic block in **type I hyperprolinemia** is at **proline dehydrogenase**. There is no associated impairment of hydroxyproline catabolism. The metabolic block in **type II hyperprolinemia** is at Δ¹-pyrroline-5-carboxylate dehydrogenase, which also participates in the catabolism of arginine, ornithine, and hydroxyproline (see below). Since proline and hydroxyproline catabolism are affected, both Δ¹-pyrroline-5-carboxylate and Δ¹-pyrroline-3-hydroxy-5-carboxylate (Figure 29-12) are excreted.

Arginine & Ornithine

The initial reactions in arginine catabolism are conversion to ornithine followed by transamination of ornithine to glutamate-γ-semialdehyde (**Figure 29-4**). Subsequent catabolism of glutamate-γ-semialdehyde to **α-ketoglutarate** occurs as described for proline (Figure 29-3). Mutations in **ornithine δ-aminotransferase** (ornithine transaminase, EC 2.6.1.13) elevate plasma and urinary ornithine and are associated with **gyrate atrophy of the choroid and retina**. Treatment involves restricting dietary arginine. In the **hyperornithinemia-hyperammonemia syndrome**, a defective mitochondrial **ornithine-citrulline antiporter** (see Figure 28-16) impairs transport of ornithine into mitochondria where it participates as an intermediate in urea synthesis.

Histidine

Catabolism of histidine proceeds via urocanate, 4-imidazolone-5-propionate, and *N*-formiminoglutamate (Figlu). Formimino group transfer to tetrahydrofolate forms glutamate, then **α-ketoglutarate** (**Figure 29-5**). In **folic acid deficiency**, transfer of the formimino group is impaired, and Figlu is excreted. Excretion of Figlu following a dose of histidine thus can be used to detect folic acid deficiency. Benign disorders of histidine catabolism include **histidinemia** and **urocanic aciduria** associated with impaired **histidase**.

TABLE 29-2 Metabolic Diseases of Amino Acid Metabolism

Defective Enzyme	Enzyme Catalog Number	OMIM ^a Reference	Major Signs and Symptoms	Figure and Reaction
S-Adenosylhomocysteine hydrolase	3.3.1.1	180960	Hypermethioninemia	29-19 ③
Arginase	3.5.3.1	207800	Argininemia	29-4 ①
Cystathionine- β -synthase	4.2.1.22	236200	Homocystinuria	29-19 ④
Fumarylacetoacetate hydrolase	3.7.1.12	276700	Type-I tyrosinemia (Tyrosinosis)	29-13 ④
Glycine N-methyl-transferase	2.1.1.20	606664	Hypermethioninemia	29-13 ②
Histidine ammonia lyase (Histidase)	4.3.1.3	609457	Histidinemia & urocanic acidemia	29-5 ①
Homogentisate oxidase	1.13.11.5	607474	Alkaptonuria. Homogentisate excreted.	29-13 ③
p-Hydroxyphenylpyruvate hydroxylase	1.13.11.27	276710	Neonatal tyrosinemia	29-13 ③
Isovaleryl-CoA dehydrogenase	1.3.99.10	607036	Isovaleric acidemia	29-20 ③
Branched chain α -ketoacid decarboxylase complex		248600	Branched-chain ketonuria (MSUD)	29-20 ①
Methionine adenosyltransferase	2.5.1.6	250850	Hypermethioninemia	29-18 ①
Ornithine- δ -aminotransferase	2.6.1.13	258870	Ornithemia, gyrate atrophy	29-4 ②
Phenylalanine hydroxylase	1.14.16.1	261600	Type I (classic) phenylketonuria	27-10 ①
Proline dehydrogenase	1.5.99.8	606810	Type I hyperprolinemia	29-3 ①
Δ^1 -Pyrroline-5-carboxylate dehydrogenase	1.5.1.12	606811	Type II hyperprolinemia & hyper 4-hydroxyprolinemia	29-3 ②
Saccharopine dehydrogenase	1.5.1.7	268700	Saccharopinuria	29-15 ②
Tyrosine aminotransferase	2.6.1.15	613018	Type II tyrosinemia	29-13 ①

^aOnline Mendelian Inheritance in Man database: ncbi.nlm.nih.gov/omim/

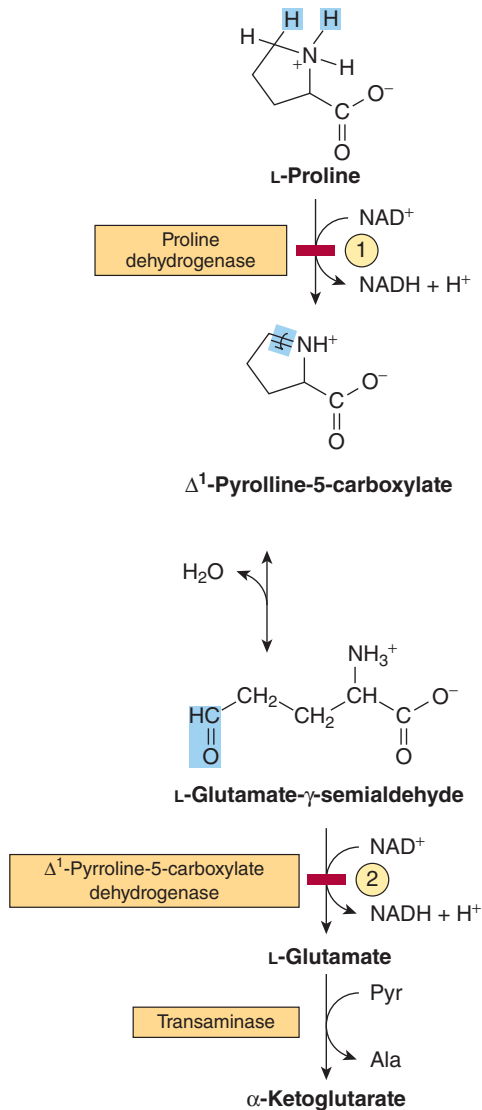
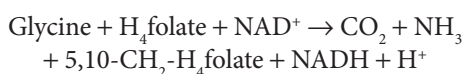

FIGURE 29-3 Catabolism of proline. Red bars and circled numerals indicate the locus of the inherited metabolic defects in ① type-I hyperprolinemia and ② type-II hyperprolinemia.

CATABOLISM OF GLYCINE, SERINE, ALANINE, CYSTEINE, THREONINE, & 4-HYDROXYPROLINE

Glycine

The **glycine cleavage complex** of liver mitochondria splits glycine to CO_2 and NH_4^+ and forms N^5, N^{10} -methylene tetrahydrofolate.



The glycine cleavage system (Figure 29-6) consists of three enzymes and an “H-protein” that has a covalently attached dihydrolipoyl moiety. Figure 29-6 also illustrates the individual reactions and intermediates in glycine cleavage. In

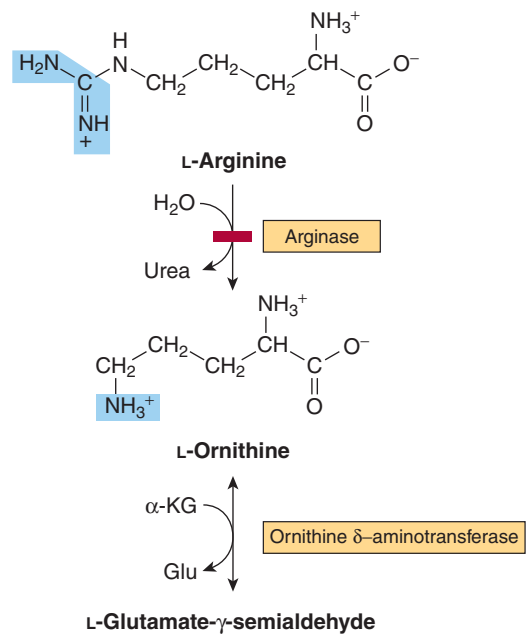

FIGURE 29-4 Catabolism of arginine. Arginase-catalyzed cleavage of L-arginine forms urea and L-ornithine. This reaction (red bar) represents the site of the inherited metabolic defect in hyperargininemia. Subsequent transamination of ornithine to glutamate- γ -semialdehyde is followed by conversion to α -ketoglutarate.

nonketotic hyperglycinemia, a rare inborn error of glycine degradation presently known only in Finland, glycine accumulates in all body tissues including the central nervous system. The defect in **primary hyperoxaluria** is the failure to catabolize glyoxylate formed by the deamination of glycine. Subsequent oxidation of glyoxylate to oxalate results in urolithiasis, nephrocalcinosis, and early mortality from renal failure or hypertension. **Glycinuria** results from a defect in renal tubular reabsorption.

Serine

Following conversion to glycine, catalyzed by glycine hydroxymethyltransferase (EC 2.1.2.1), serine catabolism merges with that of glycine (Figure 29-7).

Alanine

Transamination of α -alanine forms pyruvate. Probably on account of its central role in metabolism there is no known metabolic defect of α -alanine catabolism.

Cystine & Cysteine

Cystine is first reduced to cysteine by **cystine reductase**, EC 1.8.1.6 (Figure 29-8). Two different pathways then convert cysteine to pyruvate (Figure 29-9). There are numerous abnormalities of cysteine metabolism. Cystine, lysine, arginine, and ornithine are excreted in **cystine-lysinuria (cystinuria)**, a defect in renal reabsorption of these amino acids. Apart from cystine calculi, cystinuria is benign. The mixed disulfide of L-cysteine and L-homocysteine (Figure 29-10) excreted by

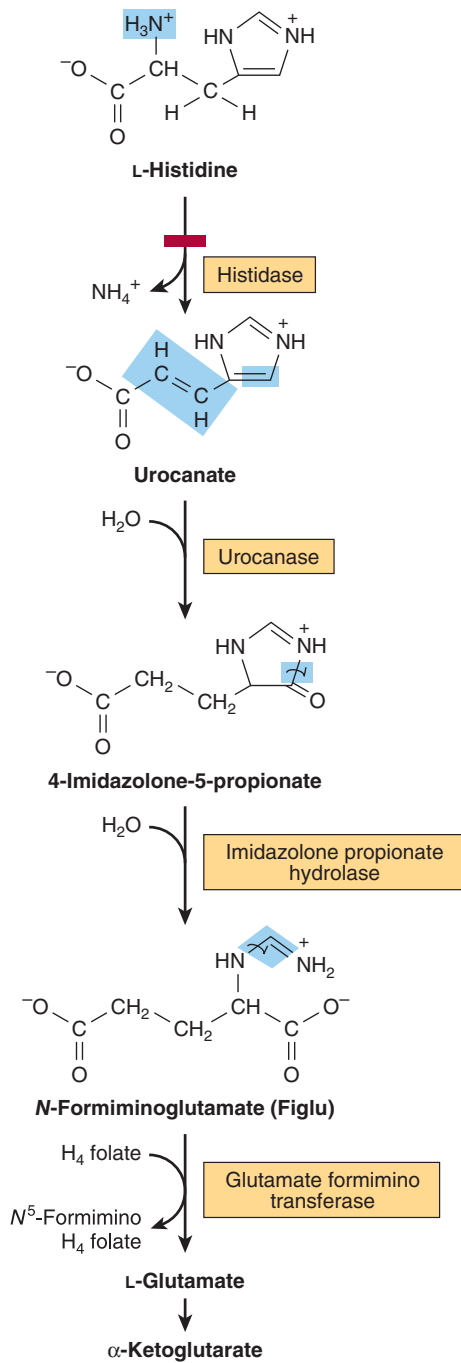
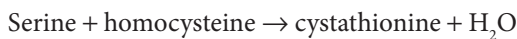

FIGURE 29-5 Catabolism of L-histidine to α-ketoglutarate. (H_4 folate, tetrahydrofolate.) The red bar indicates the site of an inherited metabolic defect.

cystinuric patients is more soluble than cystine and reduces formation of cystine calculi.

Several metabolic defects result in vitamin B_6 -responsive or vitamin B_6 -unresponsive **homocystinurias**. These include a deficiency in the reaction catalyzed by cystathionine β-synthase, EC 4.2.1.22:



Consequences include osteoporosis and mental retardation. Defective carrier-mediated transport of cystine results in

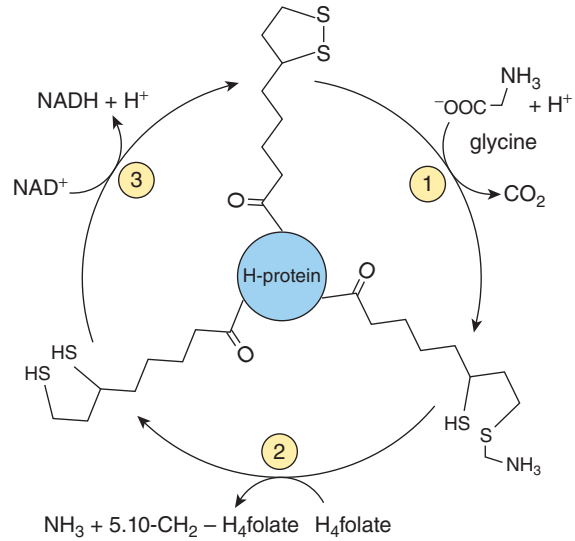

FIGURE 29-6 The glycine cleavage system of liver mitochondria. The glycine cleavage complex consists of three enzymes and an “H-protein” that has covalently attached dihydroliipoate. Catalysts for the numbered reactions are ① glycine dehydrogenase (decarboxylating), ② an ammonia-forming aminomethyltransferase, and ③ dihydroliipoamide dehydrogenase. (H_4 folate, tetrahydrofolate).

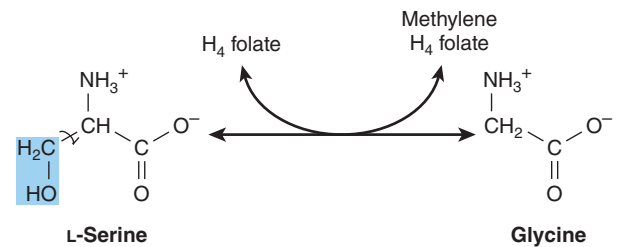

FIGURE 29-7 Interconversion of serine and glycine by glycine hydroxymethyltransferase. (H_4 folate, tetrahydrofolate)

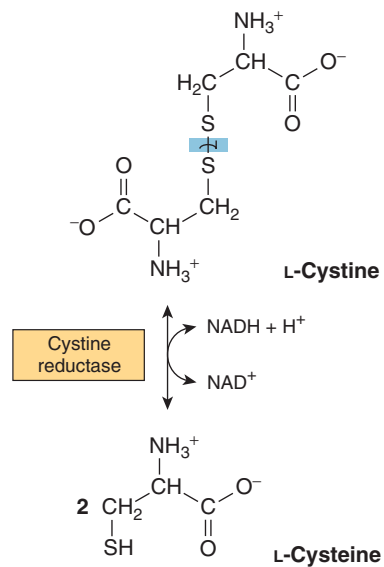

FIGURE 29-8 Reduction of cystine to cysteine in the cystine reductase reaction.

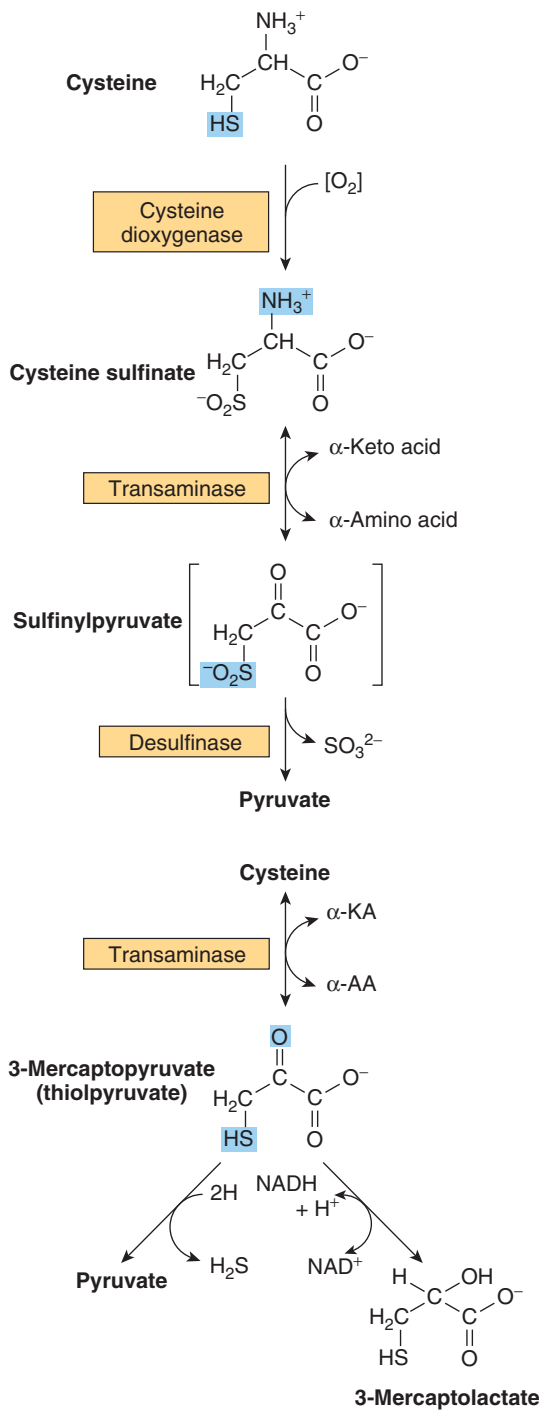

FIGURE 29-9 Two pathways catabolize cysteine: the cysteine sulfinate pathway (top) and the 3-mercaptopyruvate pathway (bottom).

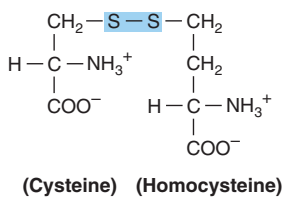

FIGURE 29-10 Structure of the mixed disulfide of cysteine and homocysteine.

cystinosis (cystine storage disease) with deposition of cystine crystals in tissues and early mortality from acute renal failure. Epidemiologic and other data link plasma homocysteine levels to cardiovascular risk, but the role of homocysteine as a causal cardiovascular risk factor remains controversial.

Threonine

Threonine aldolase (EC 4.1.2.5) cleaves threonine to glycine and acetaldehyde. Catabolism of glycine is discussed above. Oxidation of acetaldehyde to acetate is followed by formation of acetyl-CoA (Figure 29-11).

4-Hydroxyproline

Catabolism of 4-hydroxy-L-proline forms, successively, L-Δ¹-pyrroline-3-hydroxy-5-carboxylate, γ-hydroxy-L-glutamate-γ-semialdehyde, erythro-γ-hydroxy-L-glutamate, and α-keto-γ-hydroxyglutarate. An aldol-type cleavage then forms glyoxylate plus pyruvate (Figure 29-12). A defect in **4-hydroxyproline dehydrogenase** results in **hyperhydroxyprolinemia**, which is benign. There is no associated impairment of proline

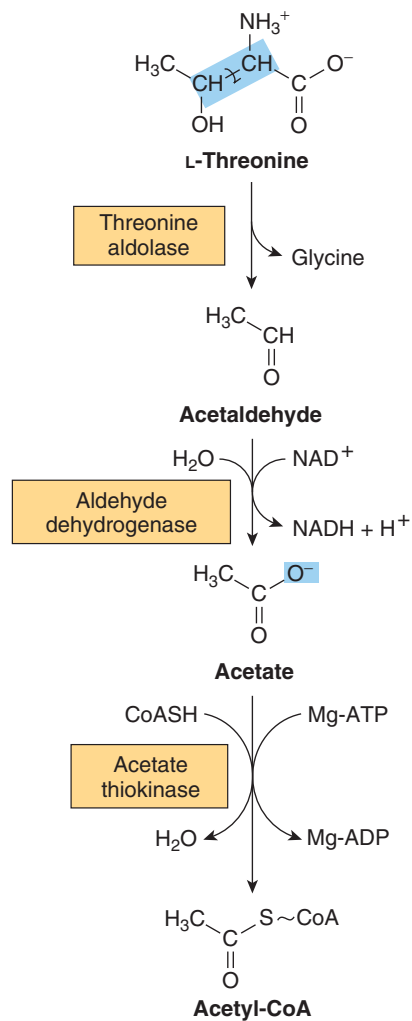

FIGURE 29-11 Intermediates in the conversion of threonine to glycine and acetyl-CoA.

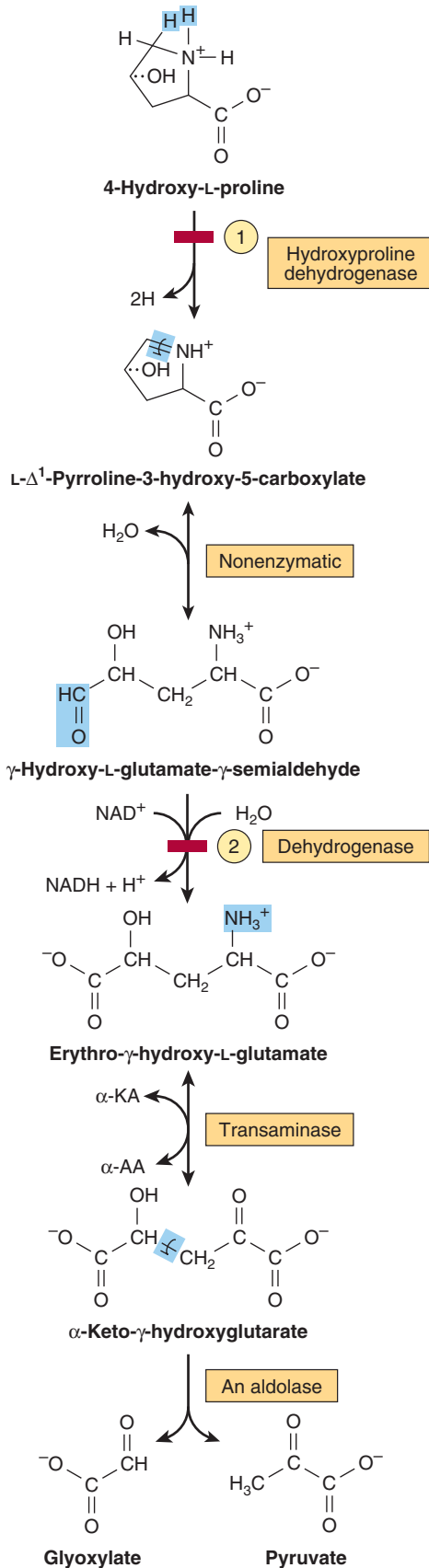

FIGURE 29-12 Intermediates in hydroxyproline catabolism. (α -AA, α -amino acid; α -KA, α -keto acid.) Red bars indicate the sites of the inherited metabolic defects in ① hyperhydroxyprolinemia and ② type II hyperprolinemia.

catabolism. A defect in **glutamate- γ -semialdehyde dehydrogenase** is accompanied by excretion of Δ^1 -pyrroline-3-hydroxy-5-carboxylate.

ADDITIONAL AMINO ACIDS THAT FORM ACETYL-CoA

Tyrosine

Figure 29-13 illustrates the intermediates and enzymes that participate in the catabolism of tyrosine to amphibolic intermediates. Following transamination of tyrosine to *p*-hydroxyphenylpyruvate, successive reactions form maleylacetoacetate, fumarylacetoacetate, fumarate, acetoacetate, and ultimately acetyl-CoA and acetate.

Several metabolic disorders are associated with the tyrosine catabolic pathway. The probable metabolic defect in **type I tyrosinemia (tyrosinosis)** is at **fumarylacetoacetate hydroxylase**, EC 3.7.1.12 (reaction 4, Figure 29-13). Therapy employs a diet low in tyrosine and phenylalanine. Untreated acute and chronic tyrosinosis leads to death from liver failure. Alternate metabolites of tyrosine are also excreted in **type II tyrosinemia (Richner-Hanhart syndrome)**, a defect in **tyrosine aminotransferase** (reaction 1, Figure 29-13), and in **neonatal tyrosinemia**, due to lowered activity of *p*-hydroxyphenylpyruvate hydroxylase, EC 1.13.11.27 (reaction 2, Figure 29-13). Therapy employs a diet low in protein.

The metabolic defect in **alkaptonuria** is a defective **homogentisate oxidase** (EC 1.13.11.5), the enzyme that catalyzes reaction 3 of Figure 29-13. The urine darkens on exposure to air due to oxidation of excreted homogentisate. Late in the disease, there is arthritis and connective tissue pigmentation (ochronosis) due to oxidation of homogentisate to benzoquinone acetate, which polymerizes and binds to connective tissue. First described in the sixteenth century based on the observation that the urine darkened on exposure to air, alkaptonuria provided the basis for Sir Archibald Garrod's early twentieth century classic ideas concerning heritable metabolic disorders. Based on the presence of ochronosis and on chemical evidence, the earliest known case of alkaptonuria is, however, its 1977 detection in an Egyptian mummy dating from 1500 B.C.

Phenylalanine

Phenylalanine is first converted to tyrosine (see Figure 27-12). Subsequent reactions are those of tyrosine (Figure 29-13). **Hyperphenylalaninemias** arise from defects in phenylalanine hydroxylase, EC 1.14.16.1 (**type I, classic phenylketonuria (PKU)**, frequency 1 in 10,000 births), in dihydrobiopterin reductase (**types II and III**), or in dihydrobiopterin biosynthesis (**types IV and V**) (see Figure 27-12). Alternative catabolites are excreted (**Figure 29-14**). A diet low in phenylalanine can prevent the mental retardation of PKU.

DNA probes facilitate prenatal diagnosis of defects in phenylalanine hydroxylase or dihydrobiopterin reductase.

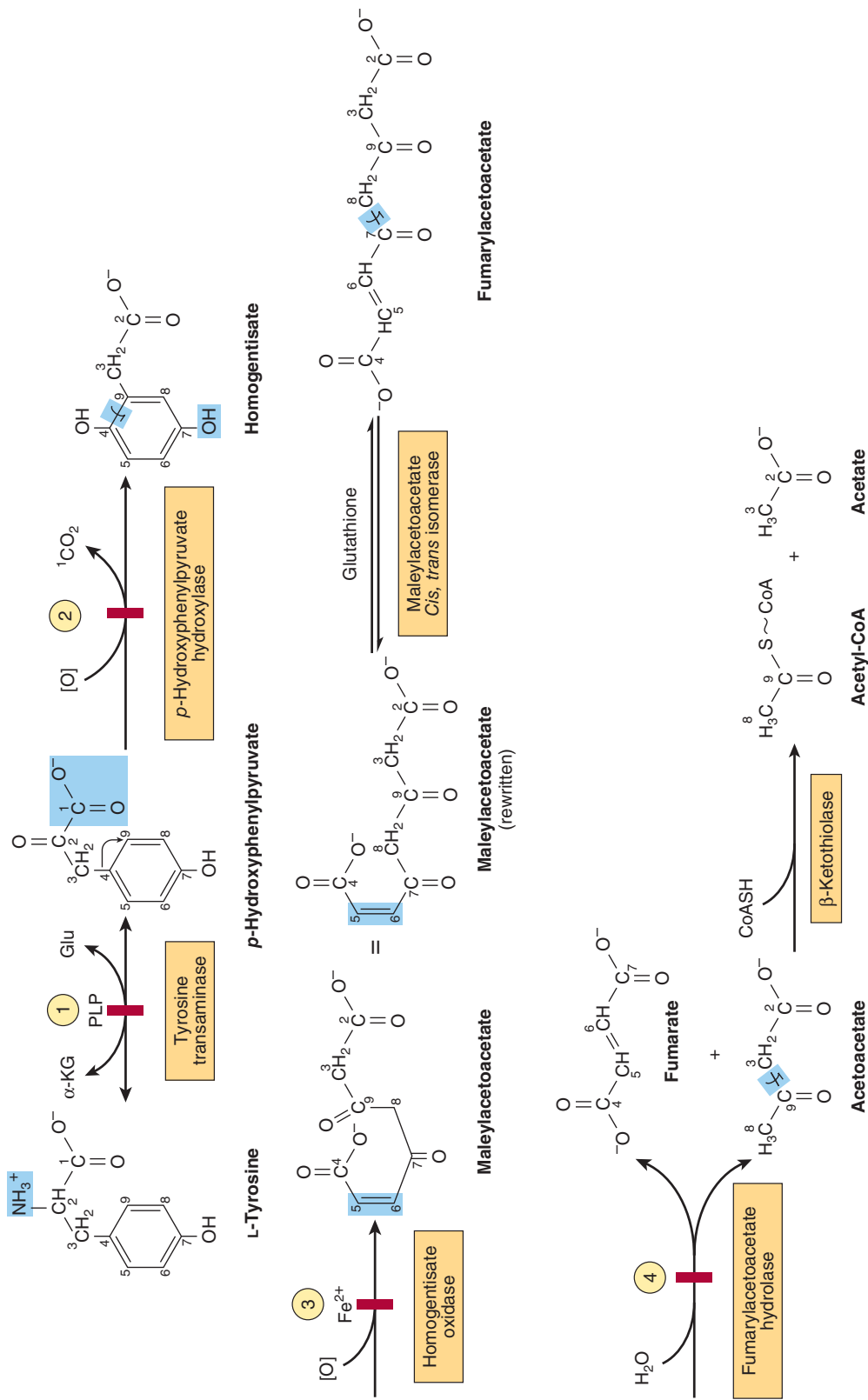

FIGURE 29-13 Intermediates in tyrosine catabolism. Carbons are numbered to emphasize their ultimate fate. (α-KG, α-ketoglutarate; Glu, glutamate; PLP, pyridoxal phosphate.) Red bars indicate the probable sites of the inherited metabolic defects in ① type I tyrosinemia; ② neonatal tyrosinemia; ③ alkaptonuria; and ④ type I tyrosinemia, or tyrosinosis.

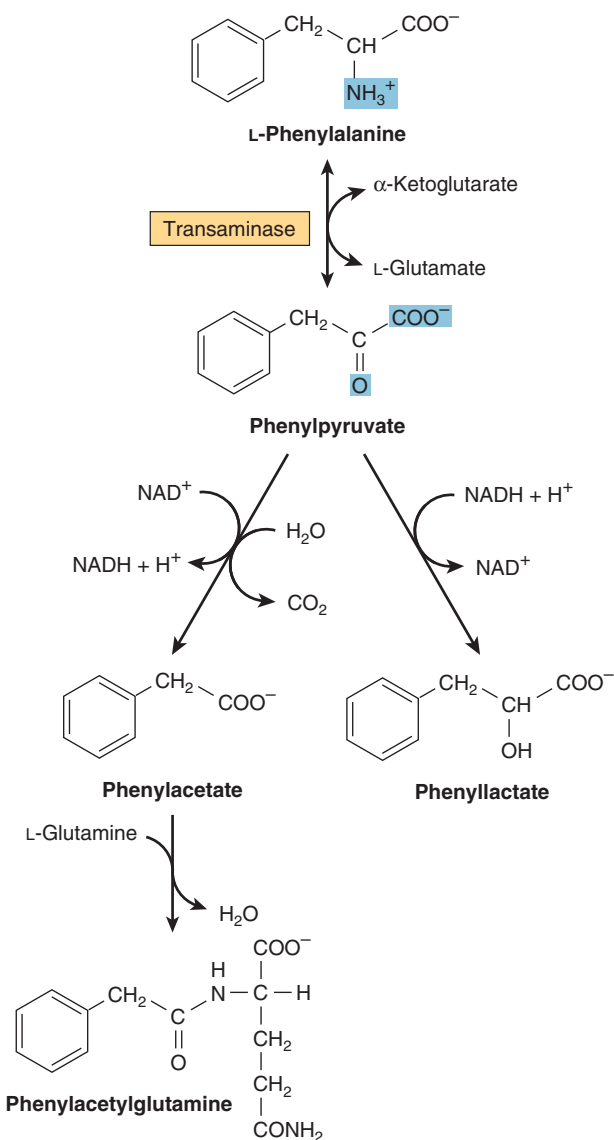

FIGURE 29-14 Alternative pathways of phenylalanine catabolism in phenylketonuria. The reactions also occur in normal liver tissue but are of minor significance.

Elevated blood phenylalanine may not be detectable until 3 to 4 days postpartum. False-positives in premature infants may reflect delayed maturation of enzymes of phenylalanine catabolism. An older and less reliable screening test employs FeCl_3 to detect urinary phenylpyruvate. FeCl_3 screening for PKU of the urine of newborn infants is compulsory in many countries, but in the United States has been largely supplanted by tandem mass spectrometry.

Lysine

The first six reactions of L-lysine catabolism in human liver form crotonyl-CoA, which is then degraded to acetyl-CoA by the reactions of fatty acid catabolism (see Chapter 22). In what follows, circled numerals refer to the corresponding numbered reactions of **Figure 29-15**. Reactions 1 and 2 convert the Schiff base formed between α -ketoglutarate and the ϵ -amino group

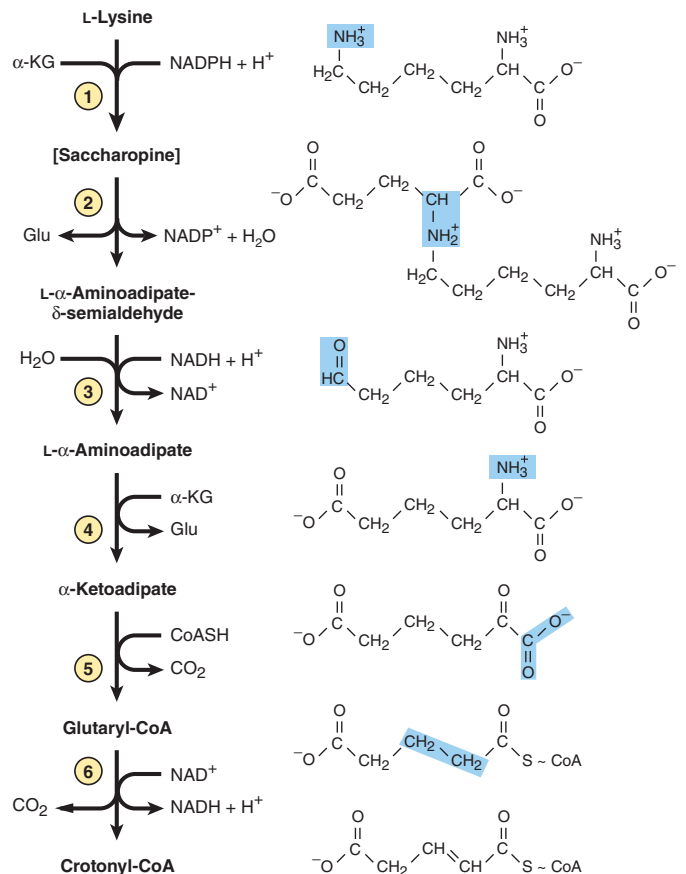

FIGURE 29-15 Reactions and intermediates in the catabolism of lysine.

of lysine to L- α -amino adipate- δ -semialdehyde. Reactions 1 and 2 both are catalyzed by a single bifunctional enzyme, amino adipate semialdehyde synthase (EC 1.5.1.8) whose N-terminal and C-terminal domains contain lysine- α -ketoglutarate reductase and saccharopine dehydrogenase activity, respectively. Reduction of L- α -amino adipate- δ -semialdehyde to L- α -amino adipate (reaction 3) is followed by transamination to α -keto adipate (reaction 4). Conversion to the thioester glutaryl-CoA (reaction 5) is followed by the decarboxylation of glutaryl-CoA to crotonyl-CoA (reaction 6). Subsequent reactions are those of fatty acid catabolism.

Hyperlysinemia can result from a metabolic defect in either the first or second activity of the bifunctional enzyme amino adipate semialdehyde synthase, but this is accompanied by elevated levels of blood saccharopine only if the defect involves the second activity. A metabolic defect at reaction 6 results in an inherited metabolic disease that is associated with striatal and cortical degeneration, and is characterized by elevated concentrations of glutarate and its metabolites glutaconate and 3-hydroxyglutarate. The challenge in management of these metabolic defects is to restrict dietary intake of L-lysine without producing malnutrition.

Tryptophan

Tryptophan is degraded to amphibolic intermediates via the kynurenine-anthranilate pathway (**Figure 29-16**). **Tryptophan**

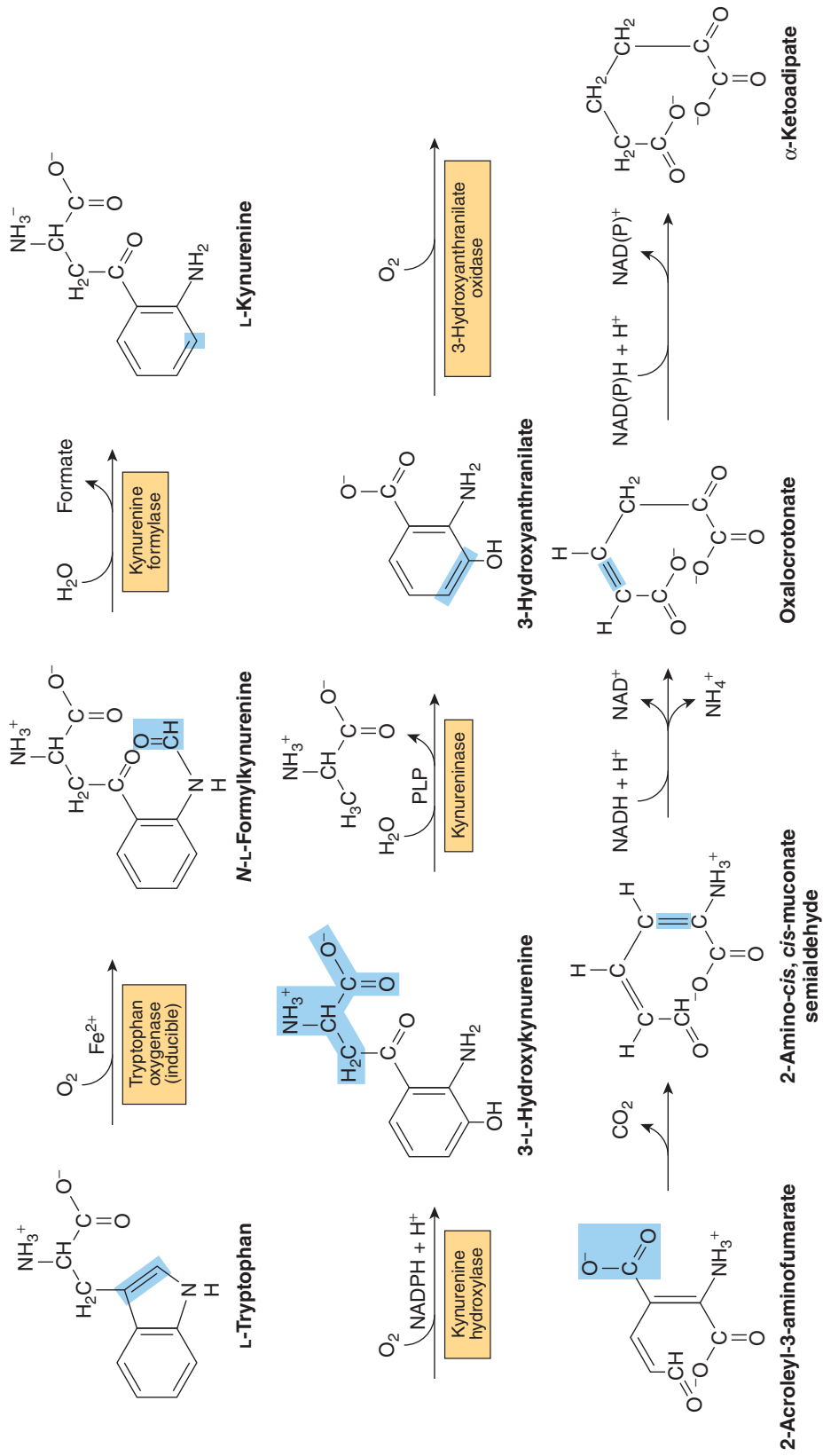

FIGURE 29-16 Reactions and intermediates in the catabolism of tryptophan. (PLP, pyridoxal phosphate.)

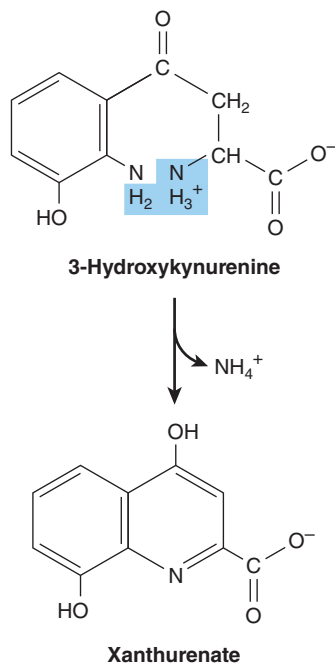

FIGURE 29-17 Formation of xanthurenate in vitamin B₆ deficiency. Conversion of the tryptophan metabolite 3-hydroxykynurenine to 3-hydroxyanthranilate is impaired (see Figure 29-16). A large portion is therefore converted to xanthurenate.

2,3-dioxygenase, EC 1.13.11.11 (**tryptophan pyrrolase**) opens the indole ring, incorporates molecular oxygen, and forms *N*-formylkynurenine. Tryptophan oxygenase, an iron porphyrin metalloprotein that is inducible in liver by adrenal corticosteroids and by tryptophan, is feedback inhibited by nicotinic acid derivatives, including NADPH. Hydrolytic removal of the formyl group of *N*-formylkynurenine, catalyzed by **kynurenine formylase** (EC 3.5.1.9), produces kynurenine. Since **kynureninase** (EC 3.7.1.3) requires pyridoxal phosphate, excretion of xanthurenate (**Figure 29-17**) in response to a tryptophan load

is diagnostic of vitamin B₆ deficiency. **Hartnup disease** reflects impaired intestinal and renal transport of tryptophan and other neutral amino acids. Indole derivatives of unabsorbed tryptophan formed by intestinal bacteria are excreted. The defect limits tryptophan availability for niacin biosynthesis and accounts for the pellagra-like signs and symptoms.

Methionine

Methionine reacts with ATP forming *S*-adenosylmethionine, “active methionine” (**Figure 29-18**). Subsequent reactions form propionyl-CoA (**Figure 29-19**), which three subsequent reactions convert to succinyl-CoA (see Figure 19-2).

THE INITIAL REACTIONS ARE COMMON TO ALL THREE BRANCHED-CHAIN AMINO ACIDS

The first three reactions of the catabolism of isoleucine, leucine, and valine (**Figure 29-20**) are analogous to reactions of fatty acid catabolism (see Figure 22-3). Following transamination (Figure 29-20, reaction 1), the carbon skeletons of the resulting α -keto acids undergo oxidative decarboxylation and conversion to coenzyme A thioesters. This multistep process is catalyzed by the **mitochondrial branched-chain α -keto acid dehydrogenase complex**, whose components are functionally identical to those of the pyruvate dehydrogenase complex (PDH) (see Figure 18-5). Like PDH, the branched-chain α -ketoacid dehydrogenase complex consists of five components.

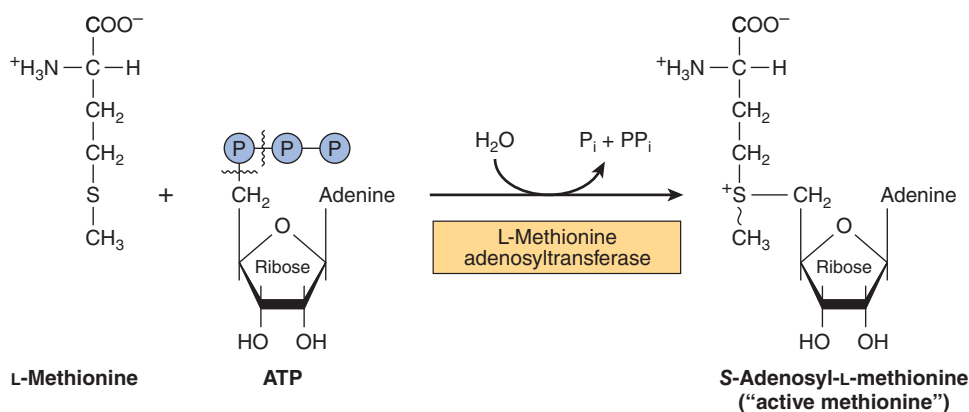

FIGURE 29-18 Formation of *S*-adenosylmethionine. ~CH₃ represents the high group transfer potential of “active methionine.”

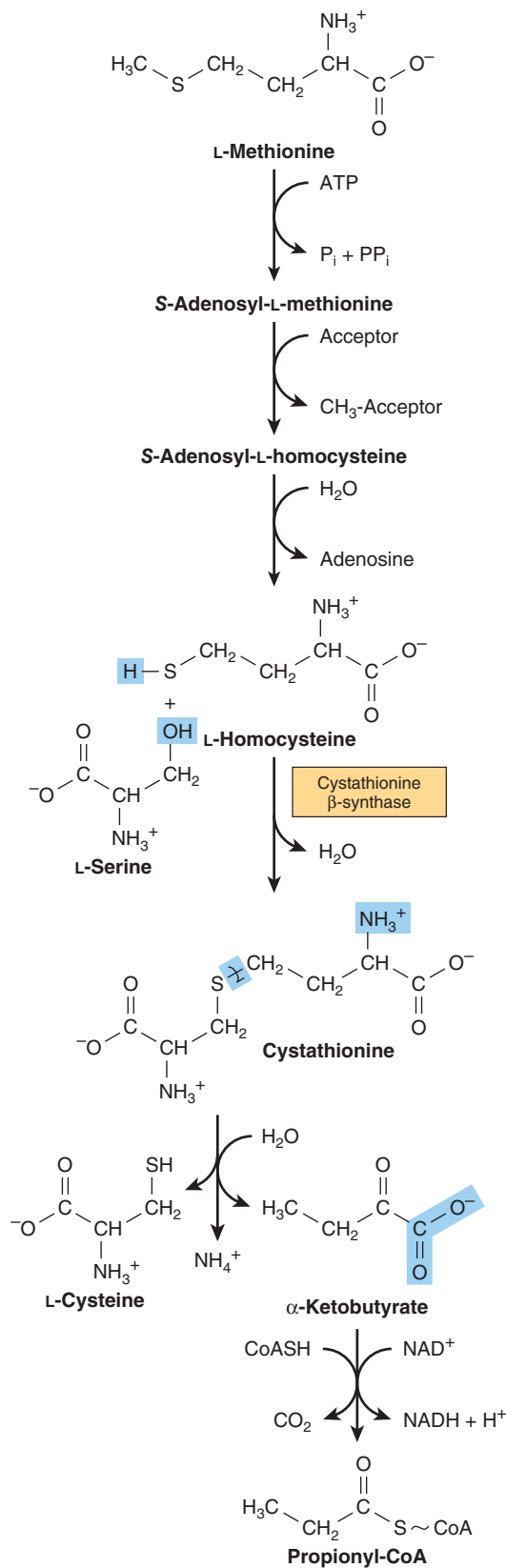

FIGURE 29-19 Conversion of methionine to propionyl-CoA.

E1: thiamin pyrophosphate (TPP)-dependent branched-chain α -ketoacid decarboxylase

E2: dihydrolipoyl transacylase (contains lipoamide)

E3: dihydrolipoamide dehydrogenase (contains FAD)

Protein kinase

Protein phosphatase

As for pyruvate dehydrogenase, the protein kinase and protein phosphatase regulate activity of the branched-chain α -keto acid dehydrogenase complex via phosphorylation (inactivation) and dephosphorylation (activation).

Dehydrogenation of the resulting coenzyme A thioesters (reaction 3, Figure 29-20) proceeds like the dehydrogenation of lipid-derived fatty acyl-CoA thioesters (see Chapter 22). Subsequent reactions that are unique for each amino acid skeleton are given in **Figures 29-21, 29-22, and 29-23**.

METABOLIC DISORDERS OF BRANCHED-CHAIN AMINO ACID CATABOLISM

As the name implies, the odor of urine in **maple syrup urine disease (branched-chain ketonuria, or MSUD)** suggests maple syrup, or burnt sugar. The biochemical defect in MSUD involves the **α -keto acid decarboxylase complex** (reaction 2, Figure 29-20). Plasma and urinary levels of leucine, isoleucine, valine, and their α -keto acids and α -hydroxy acids (reduced α -keto acids) are elevated, but the urinary keto acids derive principally from leucine. Signs and symptoms of MSUD include often fatal ketoacidosis, neurological derangements, mental retardation, and a maple syrup odor of urine. The mechanism of toxicity is unknown. Early diagnosis by enzymatic analysis is essential to avoid brain damage and early mortality by replacing dietary protein by an amino acid mixture that lacks leucine, isoleucine, and valine.

The molecular genetics of MSUD are heterogeneous. MSUD can result from mutations in the genes that encode E1 α , E1 β , E2, and E3. Based on the locus affected, genetic subtypes of MSUD are recognized. Type IA MSUD arises from mutations in the E1 α gene, type IB in the E1 β gene, type II in the E2 gene, and type III in the E3 gene (**Table 29-3**). In **intermittent branched-chain ketonuria**, the α -keto acid decarboxylase retains some activity, and symptoms occur later in life. In **isovaleric acidemia**, ingestion of protein-rich foods elevates isovalerate, the deacylation product of isovaleryl-CoA. The impaired enzyme in **isovaleric acidemia** is **isovaleryl-CoA dehydrogenase**, EC 1.3.99.10 (reaction 3, Figure 29-20). Vomiting, acidosis, and coma follow ingestion of excess protein. Accumulated isovaleryl-CoA is hydrolyzed to isovalerate and excreted.

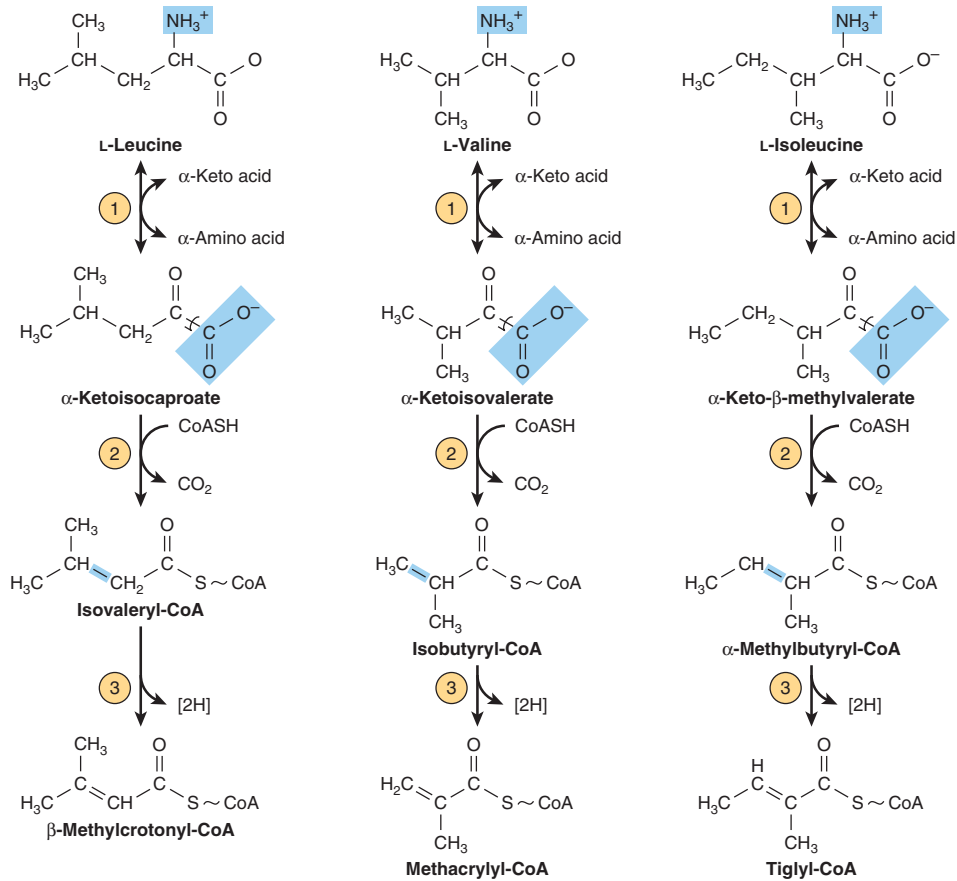

FIGURE 29-20 The first three reactions in the catabolism of leucine, valine, and isoleucine. Note the analogy of reactions 2 and 3 to reactions of the catabolism of fatty acids (see Figure 22-3). The analogy to fatty acid catabolism continues, as shown in subsequent figures.

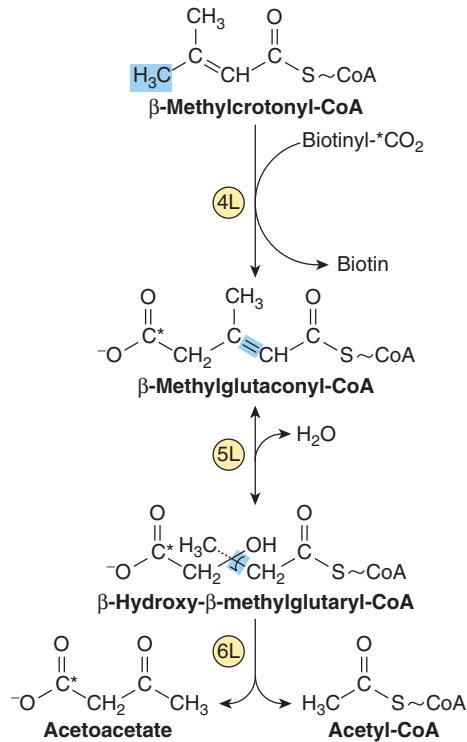

FIGURE 29-21 Catabolism of the β -methylcrotonyl-CoA formed from L-leucine. Asterisks indicate carbon atoms derived from CO_2 .

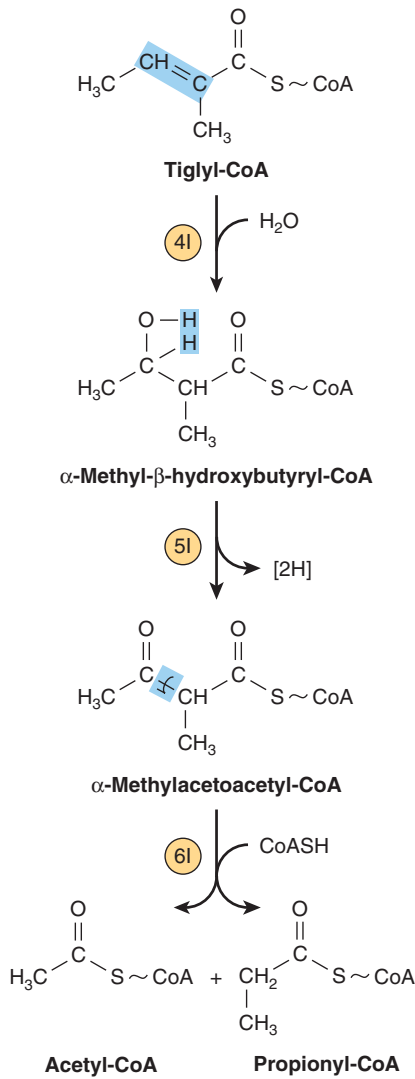

FIGURE 29-22 Subsequent catabolism of the tiglyl-CoA formed from L-isoleucine.

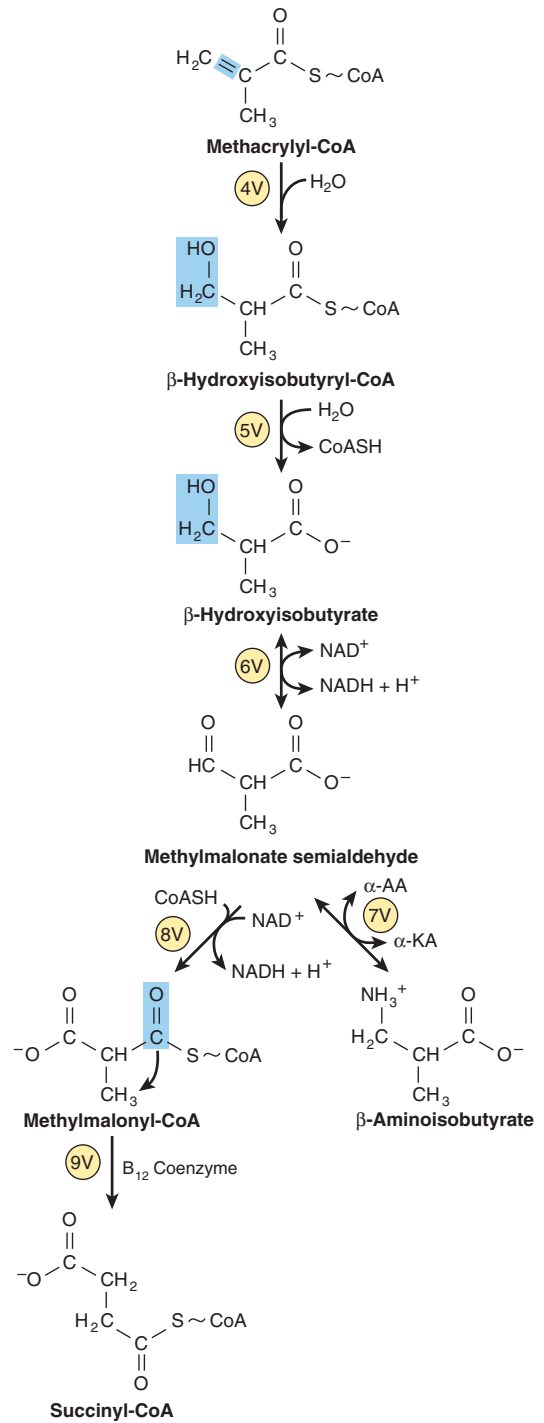

FIGURE 29-23 Subsequent catabolism of the methacrylyl-CoA formed from L-valine (see Figure 29-20). (α -AA, α -amino acid; α -KA, α -keto acid.)

TABLE 29-3 Maple Syrup Urine Disease Can Reflect Impaired Function of Various Components of the α -Ketoacid Decarboxylase Complex

Branched-Chain α -Ketoacid Decarboxylase Component	OMIM ^a Reference	Maple Syrup Urine Disease	
E1 α	α -Ketoacid decarboxylase	608348	Type 1A
E1 β	α -Ketoacid decarboxylase	248611	Type 1B
E2	Dihydrolipoyl transacylase	608770	Type II
E3	Dihydrolipoamide dehydrogenase	238331	Type III

^aOnline Mendelian Inheritance in Man database: ncbi.nlm.nih.gov/omim/

SUMMARY

- Excess amino acids are catabolized to amphibolic intermediates that serve as sources of energy or for the biosynthesis of carbohydrates and lipids.
- Transamination is the most common initial reaction of amino acid catabolism. Subsequent reactions remove any additional nitrogen and restructure hydrocarbon skeletons for conversion to oxaloacetate, α -ketoglutarate, pyruvate, and acetyl-CoA.
- Metabolic diseases associated with glycine catabolism include glycinuria and primary hyperoxaluria.
- Two distinct pathways convert cysteine to pyruvate. Metabolic disorders of cysteine catabolism include cystine-lysinuria, cystine storage disease, and the homocystinurias.
- Threonine catabolism merges with that of glycine after threonine aldolase cleaves threonine to glycine and acetaldehyde.
- Following transamination, the carbon skeleton of tyrosine is degraded to fumarate and acetoacetate. Metabolic diseases of tyrosine catabolism include tyrosinosis, Richner–Hanhart syndrome, neonatal tyrosinemia, and alkaptonuria.
- Metabolic disorders of phenylalanine catabolism include PKU and several hyperphenylalaninemias.
- Neither nitrogen of lysine participates in transamination. The same net effect is, however, achieved by the intermediate formation of saccharopine. Metabolic diseases of lysine catabolism include periodic and persistent forms of hyperlysinemia-ammonemia.
- The catabolism of leucine, valine, and isoleucine presents many analogies to fatty acid catabolism. Metabolic disorders of branched-chain amino acid catabolism include hypervalinemia, maple syrup urine disease, intermittent branched-chain ketonuria, isovaleric acidemia, and methylmalonic aciduria.

REFERENCES

- Blikrud YT, Brodtkorb E, Andresen PA, et al: Tyrosinemia type I, de novo mutation in liver tissue suppressing an inborn splicing defect. *J Mol Med* 2005;83:406.
- Dobrowolski, SF Pey AL, Koch R, et al: Biochemical characterization of mutant phenylalanine hydroxylase enzymes and correlation with clinical presentation in hyperphenylalaninaemic patients. *J Inherit Metab Dis* 2009;32:10.
- Faggioli S, Daina E, D'Antiga L, et al: Monogenic diseases that can be cured by liver transplantation. *J Hepatol* 2013;59:595.
- Garg U, Dasouki M: Expanded newborn screening of inherited metabolic disorders by tandem mass spectrometry. Clinical and laboratory aspects. *Clin Biochem* 2006;39:315.
- Geng J, Liu A: Heme-dependent dioxygenases in tryptophan oxidation. *Arch Biochem Biophys* 2014;44:18.
- Häussinger D, Schliess F: Glutamine metabolism and signaling in the liver. *Front Biosci* 2007;12:371.
- Heldt K, Schwahn B, Marquardt I, et al: Diagnosis of maple syrup urine disease by newborn screening allows early intervention without extraneous detoxification. *Mol Genet Metab* 2005;84:313.
- Houten SM, Te Brinke H, Denis S, et al: Genetic basis of hyperlysinemia. *Orphanet J Rare Dis* 2013;8:57.
- Lamp J, Keyser B, Koeller DM, et al: Glutaric aciduria type 1 metabolites impair the succinate transport from astrocytic to neuronal cells. *J Biol Chem* 2011;286:17,777.
- Mayr JA, Feichtinger RG, Tort F, et al: Lipoic acid biosynthesis defects. *J Inherit Metab Dis* 2014;37:553.
- Mitsubuchi H, Nakamura K, Matsumoto S, et al: Inborn errors of proline metabolism. *J Nutr* 2008;138:2016S.
- Moshal K, Camel CK, Kartha GK, et al: Cardiac dys-synchronization and arrhythmia in hyperhomocysteinemia. *Curr Neurovasc Res* 2007;4:289.
- Muller E, Kolker S: Reduction of lysine intake while avoiding malnutrition: major goals and major problems in dietary treatment of glutaryl-CoA dehydrogenase deficiency. *J Inherit Metab Dis* 2004;27:903.
- Nagao M, Tanaka T, Furujo M: Spectrum of mutations associated with methionine adenosyltransferase I/III deficiency among individuals identified during newborn screening in Japan. *Mol Genet Metab* 2013;110:460.
- Scriver CR, Sly WS, Childs B, et al (editors): *The Metabolic and Molecular Bases of Inherited Disease*, 8th ed. McGraw-Hill, 2001.
- Stenn FF, Milgram JW, Lee SL, et al: Biochemical identification of homogentisic acid pigment in an ochronotic Egyptian mummy. *Science* 1977;197:566.
- Tondo M, Calpena E, Arriola G, et al: Clinical, biochemical, molecular and therapeutic aspects of 2 new cases of 2-aminoacidic semialdehyde synthase deficiency. *Mol Genet Metab* 2013;110:231.
- Wilcken B, Wiley V: Newborn screening. *Pathology* 2008;40:104.

Conversion of Amino Acids to Specialized Products

Victor W. Rodwell, PhD

OBJECTIVES

After studying this chapter, you should be able to:

- Cite examples of how amino acids participate in a variety of biosynthetic processes other than protein synthesis.
- Outline how arginine participates in the biosynthesis of creatine, nitric oxide (NO), putrescine, spermine, and spermidine.
- Indicate the contribution of cysteine and of β -alanine to the structure of coenzyme A.
- Discuss the role played by glycine in drug catabolism and excretion.
- Document the role of glycine in the biosynthesis of heme, purines, creatine, and sarcosine.
- Identify the enzyme and the reaction that convert an amino acid to the neurotransmitter histamine.
- Document the role of *S*-adenosylmethionine in metabolism.
- Recognize the tryptophan metabolites serotonin, melatonin, tryptamine, and indole 3-acetate.
- Indicate the role of tyrosine in the formation of norepinephrine and epinephrine.
- Illustrate the key roles of peptidyl serine, threonine, and tyrosine in metabolic regulation and signal transduction pathways.
- Outline the roles of glycine, arginine, and *S*-adenosylmethionine in the biosynthesis of creatine.
- Describe the role of creatine phosphate in energy homeostasis.
- Describe the formation of γ -aminobutyrate (GABA) and the rare metabolic disorders associated with defects in GABA catabolism.

BIOMEDICAL IMPORTANCE

Certain proteins contain amino acids that have been post-translationally modified to permit them to perform specific functions. Examples include the carboxylation of glutamate to form γ -carboxyglutamate, which functions in Ca^{2+} binding, the hydroxylation of proline for incorporation into the collagen triple helix, and the hydroxylation of lysine to 5-hydroxylysine, whose subsequent modification and cross-linking stabilizes maturing collagen fibers. In addition to serving as the building blocks for protein synthesis, amino acids serve as

precursors of diverse biologic materials such as heme, purines, pyrimidines, hormones, neurotransmitters, and biologically active peptides. Histamine plays a central role in many allergic reactions. Neurotransmitters derived from amino acids include γ -aminobutyrate, 5-hydroxytryptamine (serotonin), dopamine, norepinephrine, and epinephrine. Many drugs used to treat neurologic and psychiatric conditions act by altering the metabolism of these neurotransmitters. Discussed below are the metabolism and metabolic roles of selected α - and non- α -amino acids.

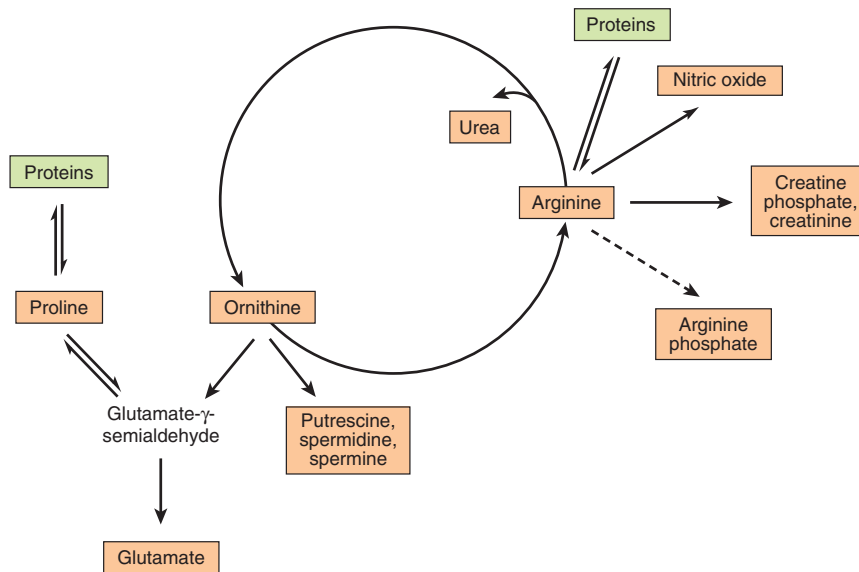

FIGURE 30-1 Arginine, ornithine, and proline metabolism. Reactions with solid arrows all occur in mammalian tissues. Putrescine and spermine synthesis occurs in both mammals and bacteria. Arginine phosphate of invertebrate muscle functions as a phosphagen analogous to creatine phosphate of mammalian muscle.

L- α -AMINO ACIDS

Alanine

Alanine serves as a carrier of ammonia and of the carbons of pyruvate from skeletal muscle to liver via the Cori cycle (see Chapter 19), and together with glycine constitutes a major fraction of the free amino acids in plasma.

Arginine

Figure 30-1 summarizes the metabolic fates of arginine. In addition to serving as a carrier of nitrogen atoms in urea biosynthesis (see **Figure 28-16**), the guanidino group of arginine is incorporated into creatine, and following conversion to ornithine, its carbon skeleton becomes that of the polyamines putrescine and spermine (see below).

The reaction catalyzed by NO synthase, EC 1.14.13.39 (**Figure 30-2**), a five-electron oxidoreductase with multiple cofactors, converts one nitrogen of the guanidino group of arginine to L-ornithine and NO, an intercellular signaling molecule that serves as a neurotransmitter, smooth muscle relaxant, and vasodilator (see Chapter 51).

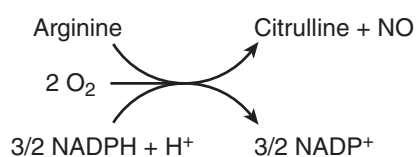

FIGURE 30-2 The reaction catalyzed by nitric oxide synthase.

Cysteine

Cysteine participates in the biosynthesis of coenzyme A (see Chapter 44) by reacting with pantothenate to form 4-phosphopantothenyl-cysteine (**Figure 30-3**). Three enzyme-catalyzed reactions convert cysteine to taurine, which can displace the coenzyme A moiety of cholesteryl-CoA to form the bile acid taurocholic acid (see Chapter 26). The conversion of cysteine to taurine is initiated by its oxidation to sulfinoalanine (cysteine sulfinic acid), catalyzed by the nonheme Fe^{2+} enzyme cysteine dioxygenase, EC 1.13.11.20. Decarboxylation of cysteine sulfinic acid by sulfinoalanine decarboxylase, EC 4.1.1.29

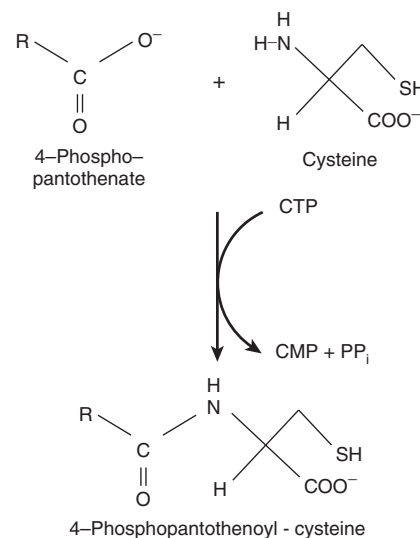

FIGURE 30-3 The reaction catalyzed by phosphopantothenate cysteine ligase (EC 6.3.2.5).

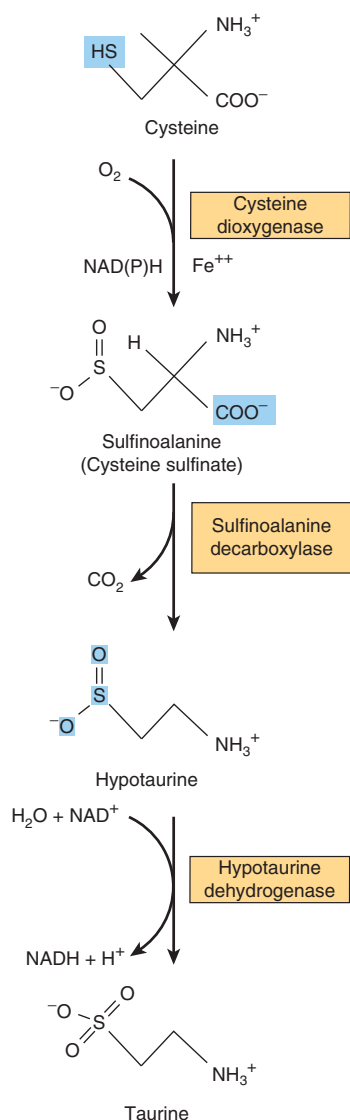

FIGURE 30-4 Conversion of cysteine to taurine. The reactions are catalyzed by cysteine dioxygenase, cysteine sulfinate decarboxylase, and hypotaurine dehydrogenase, respectively.

forms hypotaurine, whose oxidation by hypotaurine dehydrogenase (EC 1.8.1.3) forms taurine (Figure 30-4).

Glycine

Many metabolites and pharmaceuticals are excreted as water-soluble glycine conjugates. Examples include glycocholic acid (see Chapter 26) and hippuric acid formed from the food additive benzoate (Figure 30-5). Many drugs, drug metabolites, and other compounds with carboxyl groups are conjugated with glycine, which makes them more water-soluble and thereby facilitates their excretion in the urine. Glycine is incorporated into creatine, and the nitrogen and α -carbon of glycine are incorporated into the pyrrole rings and the methylene bridge carbons of heme (see Chapter 31), and the entire glycine molecule becomes atoms 4, 5, and 7 of the purines (see Figure 33-1).

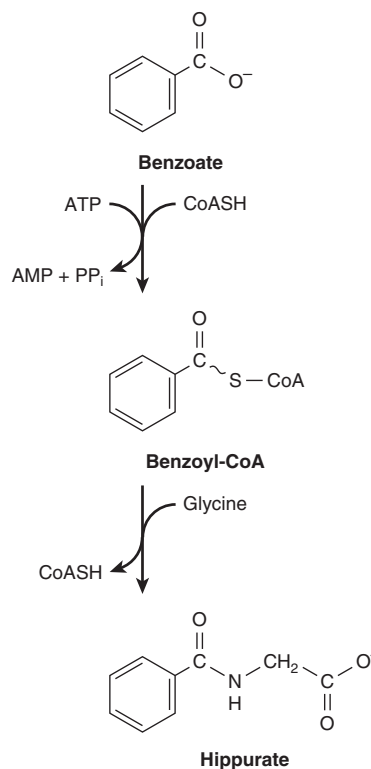

FIGURE 30-5 Biosynthesis of hippurate. Analogous reactions occur with many acidic drugs and catabolites.

Histidine

Decarboxylation of histidine to histamine is catalyzed by the pyridoxal 5'-phosphate-dependent enzyme histidine decarboxylase, EC 4.1.1.22 (Figure 30-6). A biogenic amine that functions in allergic reactions and gastric secretion, histamine is present in all tissues. Its concentration in the brain hypothalamus varies in accordance with a circadian rhythm. Histidine compounds present in the human body include carnosine, and dietarily derived ergothioneine and anserine (Figure 30-7). While their precise physiological functions are unknown, carnosine (β -alanyl-histidine) and homocarnosine (γ -aminobutyryl-histidine) are major constituents of excitable tissues, brain, and skeletal muscle. Urinary levels of 3-methylhistidine are unusually low in patients with **Wilson disease**.

Methionine

The major nonprotein fate of methionine is conversion to *S*-adenosylmethionine, the principal source of methyl groups in the body. Biosynthesis of *S*-adenosylmethionine from methionine and ATP is catalyzed by methionine

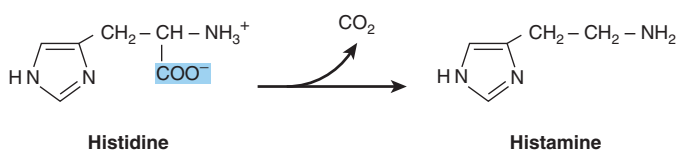

FIGURE 30-6 The reaction catalyzed by histidine decarboxylase.

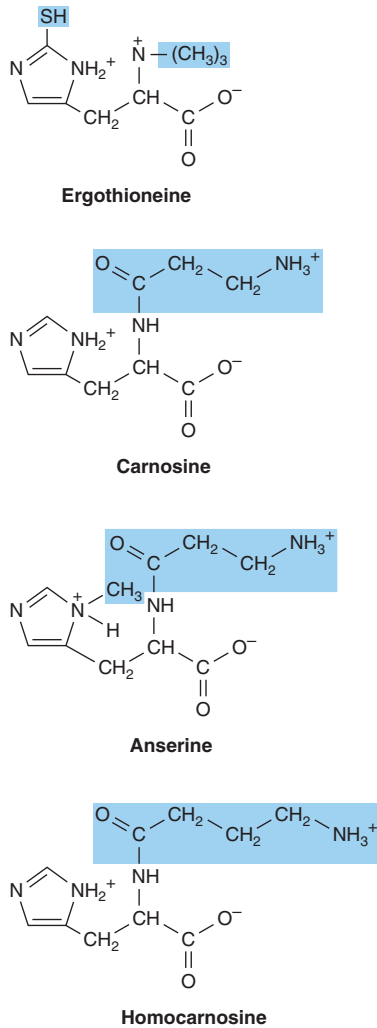

FIGURE 30-7 Derivatives of histidine. Colored boxes surround the components not derived from histidine. The SH group of ergothioneine derives from cysteine.

adenosyltransferase (MAT), EC 2.5.1.6 (**Figure 30-8**). Human tissues contain three MAT isozymes: MAT-1 and MAT-3 of liver and MAT-2 of nonhepatic tissues. Although **hypermethioninemia** can result from severely decreased hepatic MAT-1

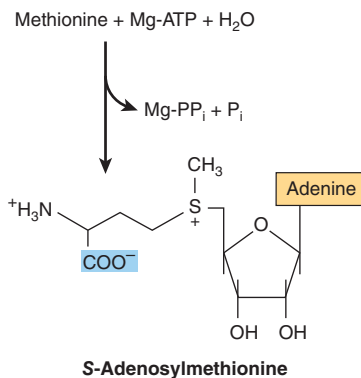

FIGURE 30-8 Biosynthesis of S-adenosylmethionine, catalyzed by methionine adenosyltransferase.

and MAT-3 activity, if there is residual MAT-1 or MAT-3 activity and MAT-2 activity is normal, a high tissue concentration of methionine will ensure synthesis of adequate amounts of S-adenosylmethionine.

Following decarboxylation of S-adenosylmethionine by methionine decarboxylase (EC 4.1.1.57), three carbons and the α -amino group of methionine contribute to the biosynthesis of the polyamines spermine and spermidine (**Figure 30-9**). These polyamines function in cell proliferation and growth, are growth factors for cultured mammalian cells, and stabilize intact cells, subcellular organelles, and membranes. Pharmacologic doses of polyamines are hypothermic and hypotensive. Since they bear multiple positive charges, polyamines readily associate with DNA and RNA. Figure 30-9 summarizes the biosynthesis of polyamines from methionine and ornithine, and **Figure 30-10** the catabolism of polyamines.

Serine

Serine participates in the biosynthesis of sphingosine (see Chapter 24), and of purines and pyrimidines, where it provides carbons 2 and 8 of purines and the methyl group of thymine (see Chapter 33). Genetic defects in cystathionine β -synthase, EC 6.3.2.3

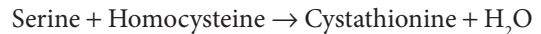

a heme protein that catalyzes the pyridoxal 5'-phosphate-dependent condensation of serine with homocysteine to form cystathionine, result in **homocystinuria**.

Tryptophan

Following hydroxylation of tryptophan to 5-hydroxytryptophan by liver tryptophan hydroxylase (EC 1.14.16.4), subsequent decarboxylation forms serotonin (5-hydroxytryptamine), a potent vasoconstrictor and stimulator of smooth muscle contraction. Catabolism of serotonin is initiated by deamination to 5-hydroxyindole-3-acetate, a reaction catalyzed by monoamine oxidase, EC 1.4.3.4 (**Figure 30-11**). The psychic stimulation that follows administration of iproniazid results from its ability to prolong the action of serotonin by inhibiting monoamine oxidase. In carcinoid (argentaffinoma), tumor cells overproduce serotonin. Urinary metabolites of serotonin in patients with carcinoid include N-acetylserotonin glucuronide and the glycine conjugate of 5-hydroxyindoleacetate. Serotonin and 5-methoxytryptamine are metabolized to the corresponding acids by monoamine oxidase. N-Acetylation of serotonin, followed by its O-methylation in the pineal body, forms melatonin. Circulating melatonin is taken up by all tissues, including brain, but is rapidly metabolized by hydroxylation followed by conjugation with sulfate or with glucuronic acid. Kidney tissue, liver tissue, and fecal bacteria all convert tryptophan to tryptamine, then to indole 3-acetate. The principal normal urinary catabolites of tryptophan are 5-hydroxyindoleacetate and indole 3-acetate.

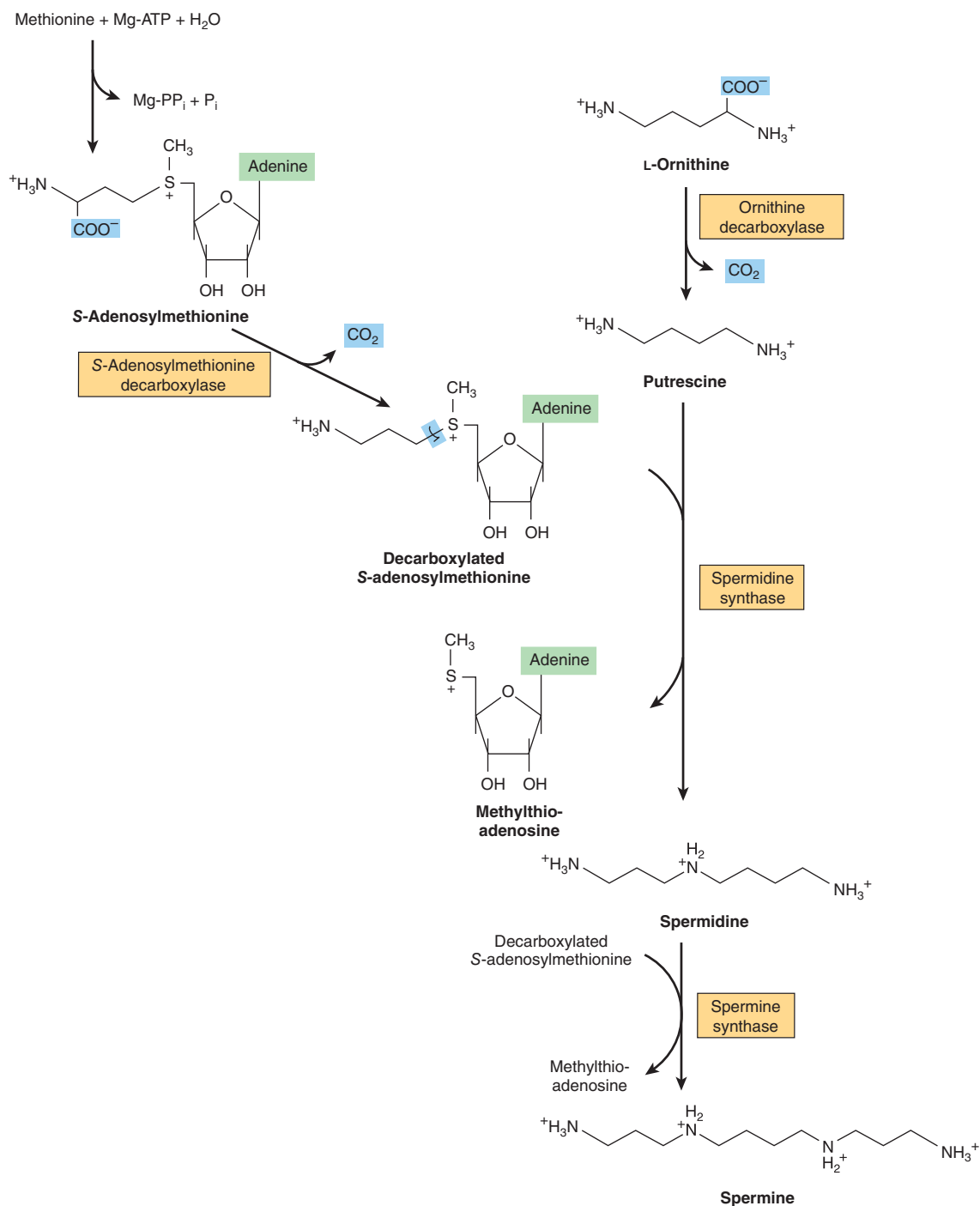

FIGURE 30–9 Intermediates and enzymes that participate in the biosynthesis of spermidine and spermine.

Tyrosine

Neural cells convert tyrosine to epinephrine and norepinephrine (**Figure 30–12**). While dopa is also an intermediate in the formation of melanin, different enzymes hydroxylate tyrosine in melanocytes. Dopa decarboxylase EC 4.1.1.28, a pyridoxal phosphate-dependent enzyme, forms dopamine. Subsequent hydroxylation, catalyzed by dopamine β -oxidase (EC 1.14.17.1), then forms norepinephrine. In the adrenal medulla, phenylethanolamine-*N*-methyltransferase (EC 2.1.1.28)

utilizes *S*-adenosylmethionine to methylate the primary amine of norepinephrine, forming epinephrine (**Figure 30–12**). Tyrosine is also a precursor of triiodothyronine and thyroxine (see Chapter 41).

Phosphoserine, Phosphothreonine, & Phosphotyrosine

The phosphorylation and dephosphorylation of specific seryl, threonyl, or tyrosyl residues of proteins regulate the activity

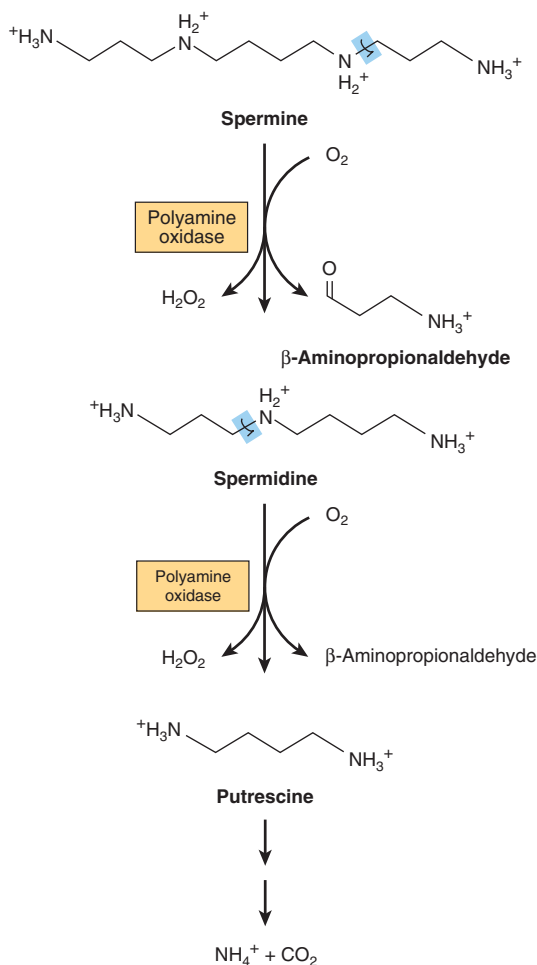
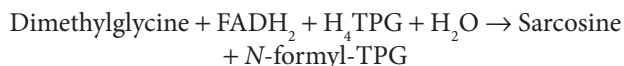

FIGURE 30-10 Catabolism of polyamines.

of certain enzymes of lipid and carbohydrate metabolism (see Chapters 9, Figures 18-20 and 22-26), and of proteins that participate in signal transduction cascades (see Chapter 42).

Sarcosine (*N*-Methylglycine)

The biosynthesis and catabolism of sarcosine (*N*-methylglycine) occur in mitochondria. Formation of sarcosine from dimethylglycine is catalyzed by the flavoprotein dimethylglycine dehydrogenase EC 1.5.99.2, which requires reduced pteroylpentaglutamate (TPG).



Traces of sarcosine can also arise by methylation of glycine, a reaction catalyzed by glycine *N*-methyltransferase, EC 2.1.1.20.

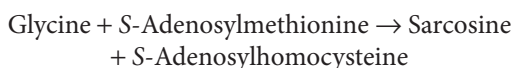

Catabolism of sarcosine to glycine, catalyzed by the flavoprotein sarcosine dehydrogenase EC 1.5.99.1, also requires reduced pteroylpentaglutamate.



The demethylation reactions that form and degrade sarcosine represent important sources of one-carbon units. FADH_2 is reoxidized via the electron transport chain (see Chapter 13).

Creatine & Creatinine

Creatinine is formed in muscle from creatine phosphate by irreversible, nonenzymatic dehydration, and loss of phosphate (Figure 30-13). Since the 24-hour urinary excretion of creatinine is proportionate to muscle mass, it provides a measure of whether a complete 24-hour urine specimen has been collected. Glycine, arginine, and methionine all participate in creatine biosynthesis. Synthesis of creatine is completed by methylation of guanidoacetate by *S*-adenosylmethionine (Figure 30-13).

NON- α -AMINO ACIDS

Non- α -amino acids present in tissues in a free form include β -alanine, β -aminoisobutyrate, and γ -aminobutyrate (GABA). β -Alanine is also present in combined form in coenzyme A, and in the β -alanyl dipeptides carnosine, anserine, and homocarnosine (see below).

β -Alanine & β -Aminoisobutyrate

β -Alanine and β -aminoisobutyrate are formed during catabolism of the pyrimidines uracil and thymine, respectively (see Figure 33-9). Traces of β -alanine also result from the hydrolysis of β -alanyl dipeptides by the enzyme carnosinase, EC 3.4.13.20. β -Aminoisobutyrate also arises by transamination of methylmalonate semialdehyde, a catabolite of *L*-valine (see Figure 29-23).

The initial reaction of β -alanine catabolism is transamination to malonate semialdehyde. Subsequent transfer of coenzyme A from succinyl-CoA forms malonyl-CoA semialdehyde, which is then oxidized to malonyl-CoA and decarboxylated to the amphibolic intermediate acetyl-CoA. Analogous reactions characterize the catabolism of β -aminoisobutyrate. Transamination forms methylmalonate semialdehyde, which is converted to the amphibolic intermediate succinyl-CoA by reactions 8V and 9V of Figure 29-23. Disorders of β -alanine and β -aminoisobutyrate metabolism arise from defects in enzymes of the pyrimidine catabolic pathway. Principal among these are disorders that result from a total or partial deficiency of dihydropyrimidine dehydrogenase (see Chapter 33).

β -Alanyl Dipeptides

The β -alanyl dipeptides carnosine and anserine (*N*-methylcarnosine) (Figure 30-7) activate myosin ATPase (EC 3.6.4.1), chelate copper, and enhance copper uptake. β -Alanyl-imidazole buffers the pH of anaerobically contracting skeletal

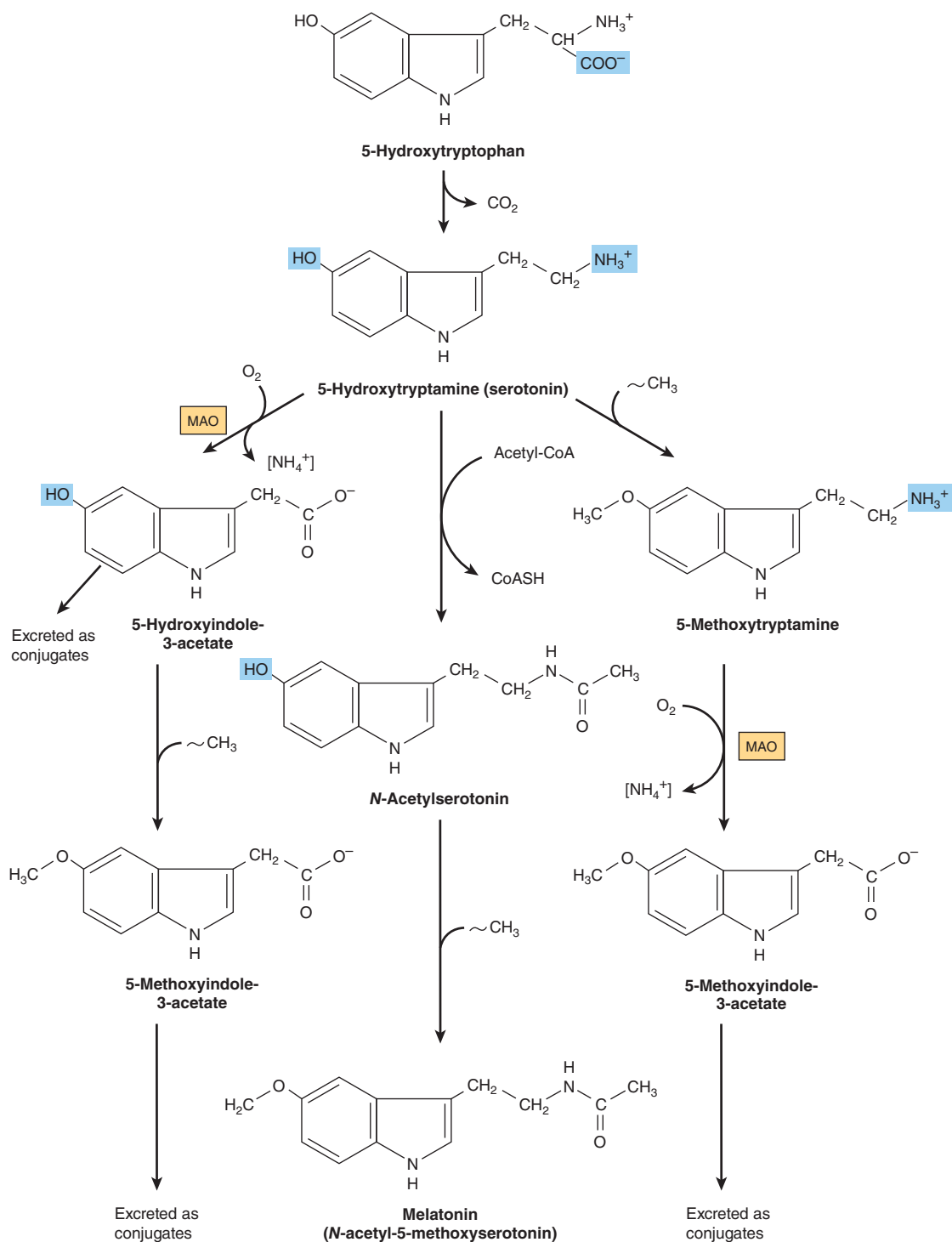
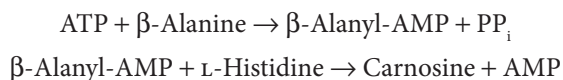

FIGURE 30-11 Biosynthesis and metabolism of serotonin and melatonin. ([NH₄⁺], by transamination; MAO, monoamine oxidase; ~CH₃, from S-adenosylmethionine.)

muscle. Biosynthesis of carnosine is catalyzed by carnosine synthase (EC 6.3.2.11) in a two-stage reaction that involves initial formation of an enzyme-bound acyl-adenylate of β -alanine and subsequent transfer of the β -alanyl moiety to L-histidine.



Hydrolysis of carnosine to β -alanine and L-histidine is catalyzed by carnosinase, EC 3.4.13.20. The heritable disorder carnosinase deficiency is characterized by **carnosinuria**.

Homocarnosine (Figure 30-7), present in human brain at higher levels than carnosine, is synthesized in brain tissue by carnosine synthase. Serum carnosinase does not hydrolyze homocarnosine. **Homocarnosinosis**, a rare genetic disorder,

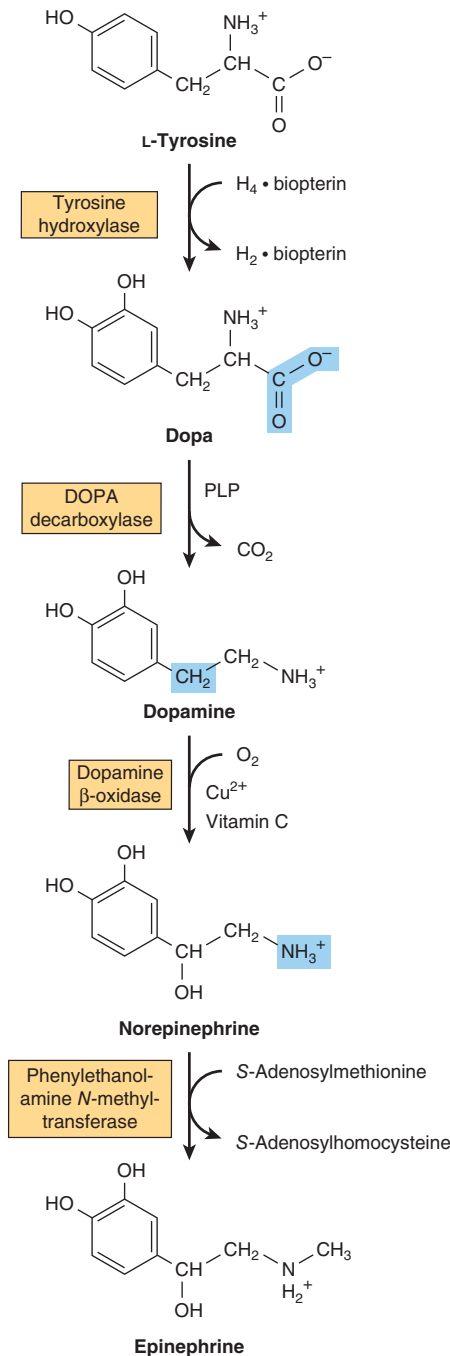

FIGURE 30-12 Conversion of tyrosine to epinephrine and norepinephrine in neuronal and adrenal cells. (PLP, pyridoxal phosphate.)

is associated with progressive spastic paraplegia and mental retardation.

γ -Aminobutyrate

γ -Aminobutyrate (GABA) functions in brain tissue as an inhibitory neurotransmitter by altering transmembrane potential differences. GABA is formed by decarboxylation of glutamate by L-glutamate decarboxylase, EC 4.1.1.15 (Figure 30-14). Transamination of γ -aminobutyrate forms succinate semialdehyde,

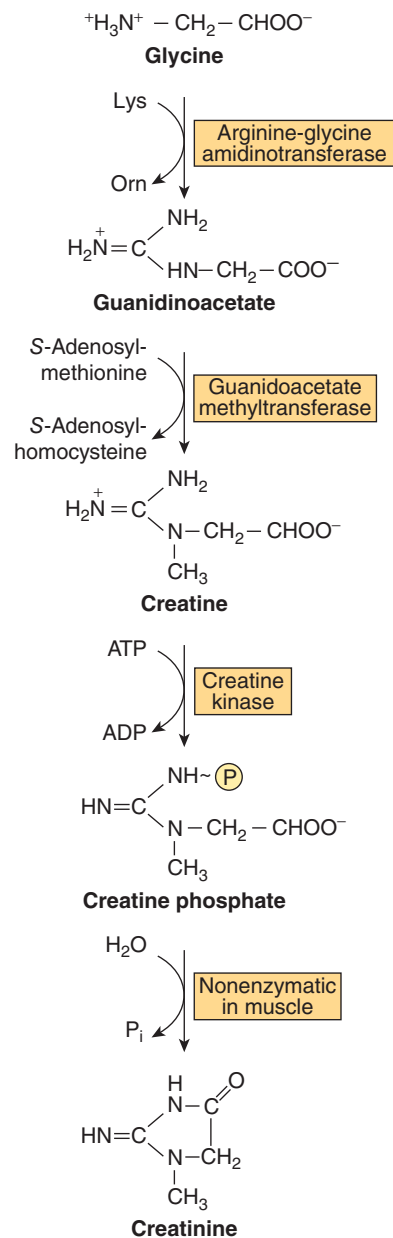

FIGURE 30-13 Biosynthesis of creatine and creatinine.

Conversion of glycine and the guanidine group of arginine to creatine and creatine phosphate. Also shown is the nonenzymic hydrolysis of creatine phosphate to creatinine.

which can be reduced to γ -hydroxybutyrate by L-lactate dehydrogenase, or be oxidized to succinate and thence via the citric acid cycle to CO_2 and H_2O (Figure 30-14). A rare genetic disorder of GABA metabolism involves a defective GABA aminotransferase EC 2.6.1.19, an enzyme that participates in the catabolism of GABA subsequent to its postsynaptic release in brain tissue. Defects in succinic semialdehyde dehydrogenase, EC 1.2.1.24 (Figure 30-14) are responsible for **4-hydroxybutyric aciduria** a rare metabolic disorder of γ -aminobutyrate catabolism characterized by the presence of 4-hydroxybutyrate in urine, plasma and cerebrospinal fluid. No present treatment is available for the accompanying mild to severe neurologic symptoms.

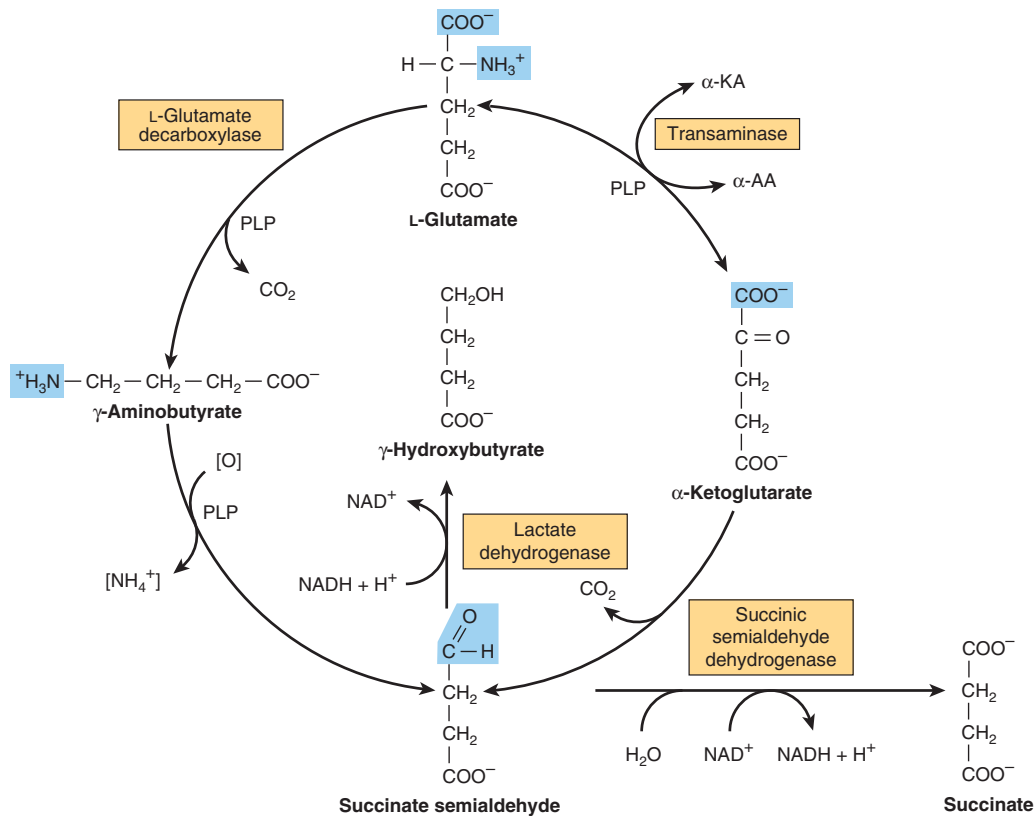

FIGURE 30-14 Metabolism of γ -aminobutyrate. (α -AA, α -amino acids; α -KA, α -keto acids; PLP, pyridoxal phosphate.)

SUMMARY

- In addition to serving structural and functional roles in proteins, α -amino acids participate in a wide variety of other biosynthetic processes.
- Arginine provides the formamidine group of creatine and the nitrogen of NO. Via ornithine, arginine provides the skeleton of the polyamines putrescine, spermine, and spermidine.
- Cysteine provides the thioethanolamine portion of coenzyme A, and following its conversion to taurine, is part of the bile acid taurocholic acid.
- Glycine participates in the biosynthesis of heme, purines, creatine, and *N*-methylglycine (sarcosine). Many drugs and drug metabolites are excreted as glycine conjugates, which increases water solubility for urinary excretion.
- Decarboxylation of histidine forms the neurotransmitter histamine. Histidine compounds present in the human body include ergothioneine, carnosine, and anserine.
- *S*-Adenosylmethionine, the principal source of methyl groups in metabolism, contributes its carbon skeleton to the biosynthesis of the polyamines spermine and spermidine.
- In addition to its roles in phospholipid and sphingosine biosynthesis, serine provides carbons 2 and 8 of purines and the methyl group of thymine.
- Key tryptophan metabolites include serotonin and melatonin. Kidney and liver tissue, and also fecal bacteria, convert

tryptophan to tryptamine and thence to indole 3-acetate. The principal tryptophan catabolites in urine are indole 3-acetate and 5-hydroxyindoleacetate.

- Tyrosine forms norepinephrine and epinephrine, and following iodination the thyroid hormones triiodothyronine and thyroxine.
- The enzyme-catalyzed interconversion of the phospho- and dephospho-forms of peptide bound serine, threonine, and tyrosine plays key roles in metabolic regulation, including signal transduction.
- Glycine, arginine, and *S*-adenosylmethionine all participate in the biosynthesis of creatine, which as creatine phosphate serves as a major energy reserve in muscle and brain tissue. Excretion in the urine of its catabolite creatinine is proportionate to muscle mass.
- β -Alanine and β -aminoisobutyrate both are present in tissues as free amino acids. β -Alanine also occurs in bound form in coenzyme A, carnosine, anserine, and homocarnosine. Catabolism of β -alanine involves stepwise conversion to acetyl-CoA. Analogous reactions catabolize β -aminoisobutyrate to succinyl-CoA. Disorders of β -alanine and β -aminoisobutyrate metabolism arise from defects in enzymes of pyrimidine catabolism.
- Decarboxylation of glutamate forms the inhibitory neurotransmitter γ -aminobutyrate (GABA). Two rare metabolic disorders are associated with defects in GABA catabolism.

REFERENCES

- Allen GF, Land JM, Heales SJ: A new perspective on the treatment of aromatic L-amino acid decarboxylase deficiency. *Mol Genet Metab* 2009;97:6.
- Blaesi EJ, Fox BG, Brunold TC: Spectroscopic and computational investigation of iron(III) cysteine dioxygenase: implications for the nature of the putative superoxo-Fe(III) intermediate. *Biochemistry* 2014;53:5759.
- Conti M, Beavo J: Biochemistry and physiology of cyclic nucleotide phosphodiesterases: essential components in cyclic nucleotide signaling. *Annu Rev Biochem* 2007;76:481.
- Karagiannidis I, Dehning S, Sandor P, et al: Support of the histaminergic hypothesis in Tourette syndrome: association of the histamine decarboxylase gene in a large sample of families. *J Med Genet* 2013;50:760.
- Komori H, Nitta Y, Ueno H, et al: Structural study reveals that Ser-354 determines substrate specificity on human histidine decarboxylase. *J Biol Chem* 2012;287:291.
- Manegold C, Hoffmann GF, Degen I, et al: Aromatic L-amino acid decarboxylase deficiency: clinical features, drug therapy and followup. *J Inherit Metab Dis* 2009;32:371.
- Moinard C, Cynober L, de Bandt JP: Polyamines: metabolism and implications in human diseases. *Clin Nutr* 2005;24:184.
- Montioli R, Dindo M, Giorgetti A, et al: A comprehensive picture of the mutations associated with aromatic amino acid decarboxylase deficiency: from molecular mechanisms to therapy implications. *Hum Mol Genet* 2014;23:5429.
- Pearl PL, Gibson KM, Cortez MA, et al: Succinic semialdehyde dehydrogenase deficiency: lessons from mice and men. *J Inherit Metab Dis* 2009;32:343.
- Pearl PL, Taylor JL, Trzcinski S, et al: The pediatric neurotransmitter disorders. *J Child Neurol* 2007;22:606.
- Pegg AE: The function of spermine. *IUBMB Life* 2014;66:8.
- Schippers KJ, Nichols, SA: Deep, dark secrets of melatonin in animal evolution. *Cell* 2014;159:9.
- Scriver CR, Sly WS, Childs B, et al (editors): *The Metabolic and Molecular Bases of Inherited Disease*, 8th ed. McGraw-Hill, 2001.
- Wu F, Yu J, Gehring H: Inhibitory and structural studies of novel coenzyme-substrate analogs of human histidine decarboxylase. *FASEB J* 2008;3:890.

Porphyrins & Bile Pigments

Victor W. Rodwell, PhD & Robert K. Murray, MD, PhD

OBJECTIVES

After studying this chapter, you should be able to:

- Identify the two amphibolic intermediates from which heme is synthesized.
- Name the key regulated enzyme of hepatic heme biosynthesis.
- Explain why, although porphyrinogens and porphyrins both are tetrapyrroles, porphyrins are colored whereas porphyrinogens are colorless.
- Appreciate that some of the enzymes of heme biosynthesis are mitochondrial and others are cytosolic.
- Indicate which steps in the conversion of heme to bilirubin are cytosolic and which are mitochondrial.
- Understand the causes and general clinical pictures of the various porphyrias.
- Explain the biochemical nature of jaundice, name some of its causes, and suggest how to approach determining its biochemical underpinnings.
- Explain what is meant by “direct bilirubin” and “indirect bilirubin.”

BIOMEDICAL IMPORTANCE

The biochemistry of the porphyrins and of the bile pigments are closely related topics. Heme is synthesized from porphyrins and iron, and the products of degradation of heme are the bile pigments and iron. The biochemistry of the porphyrins and of heme is basic to understanding the varied functions of **hemoproteins**, and the **porphyrias**, a group of diseases caused by abnormalities in the pathway of porphyrin biosynthesis. A much more common clinical condition is **jaundice**, a consequence of an elevated level of plasma bilirubin, due either to overproduction of bilirubin or to failure of its excretion. Jaundice occurs in numerous diseases ranging from hemolytic anemias to viral hepatitis and to cancer of the pancreas.

PORPHYRINS

Porphyryns are cyclic compounds formed by the linkage of four **pyrrole rings** through methyne ($=\text{HC}-$) bridges (Figure 31-1). In the naturally occurring porphyrins, various

side chains replace the eight numbered hydrogen atoms of the pyrroles. Figure 31-2 shows a shorthand representation of these substitutions. Figures 31-3 and 31-4 illustrate these substituents on selected porphyrins.

Porphyryns form complexes with metal ions that bind to the nitrogen atom of each of the four pyrrole rings. Examples include the **iron porphyryns** such as the **heme** of hemoglobin and the **magnesium-containing porphyryns** **chlorophyll**, the photosynthetic pigment of plants. Heme proteins are ubiquitous in biology and serve diverse functions including, but not limited to, oxygen transport and storage (eg, hemoglobin and myoglobin) and electron transport (eg, cytochrome *c* and cytochrome P450). Hemes are **tetrapyrroles**, of which two types, heme *b* and heme *c*, predominate (Figure 31-5). In heme *c* the vinyl groups of heme *b* are replaced by covalent thioether links to an apoprotein, typically via cysteinyl residues. Unlike heme *b*, heme *c* thus does not readily dissociate from its apoprotein. Vertebrate holoproteins generally bind one mole of heme *c* per mole, although those of nonvertebrates may bind significantly more heme. Proteins that contain heme are widely distributed in nature (Table 31-1).

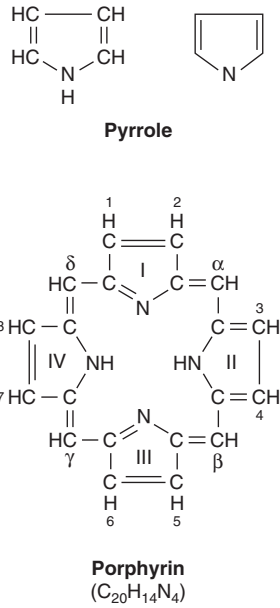
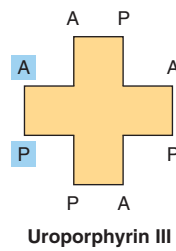
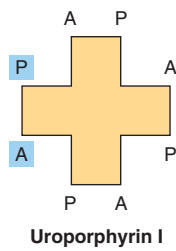
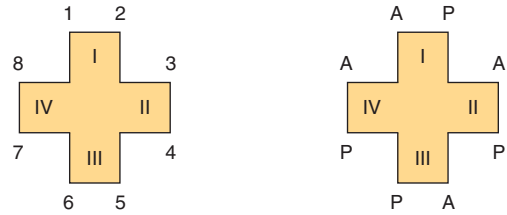
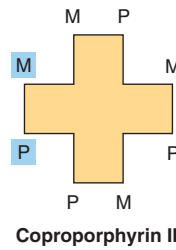
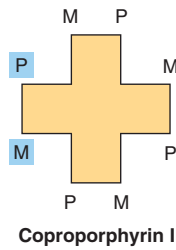

FIGURE 31-1 The porphyrin molecule. Rings are labeled I, II, III, and IV. Substituent positions are labeled 1 through 8. The four methyne bridges (=HC—) are labeled α , β , γ , and δ .



Uroporphyrins were first found in the urine, but they are not restricted to urine.



Coproporphyrins were first isolated from feces, but they are also found in urine.

FIGURE 31-3 Uroporphyrins and coproporphyrins. A = acetate; M = methyl; P = propionate. Notice that the positions of the highlighted acetate and propionate substituents are reversed in uroporphyrins I and II, and in coproporphyrins I and II.

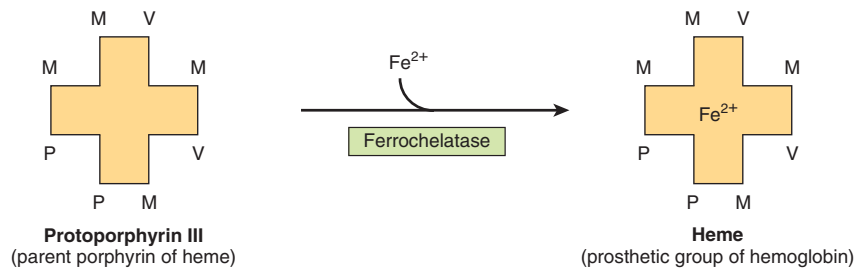

FIGURE 31-4 Addition of iron to protoporphyrin III forms heme. V = vinyl; (—CH=CH₂).

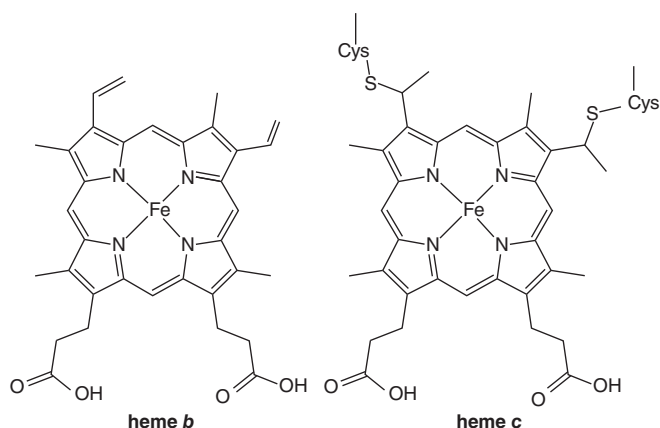

FIGURE 31-5 Structures of heme *b* and heme *c*.

TABLE 31-1 Examples of Some Important Human and Animal Hemoproteins^a

Protein	Function
Hemoglobin	Transport of oxygen in blood
Myoglobin	Storage of oxygen in muscle
Cytochrome <i>c</i>	Involvement in the electron transport chain
Cytochrome P450	Hydroxylation of xenobiotics
Catalase	Degradation of hydrogen peroxide
Tryptophan pyrrolase	Oxidation of tryptophan

^aThe functions of the above proteins are described in various chapters of this text.

HEME IS SYNTHESIZED FROM SUCCINYL-CoA & GLYCINE

Heme biosynthesis occurs in most mammalian cells except mature erythrocytes, which lack mitochondria. Approximately 85% of heme synthesis occurs in erythroid precursor cells in the **bone marrow**, and the majority of the remainder in **hepatocytes**. Heme biosynthesis is initiated by the condensation of succinyl-CoA and glycine in a pyridoxal phosphate-dependent reaction catalyzed by mitochondrial **δ -aminolevulinic synthase (ALA synthase, EC 2.3.1.37)**.

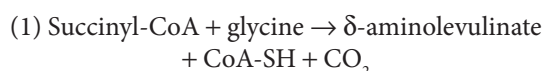

Humans express two isozymes of ALA synthase. ALAS1 is ubiquitously expressed throughout the body, whereas ALAS2 is expressed in erythrocyte precursor cells. The reaction is rate-limiting for porphyrin biosynthesis in mammalian liver. The initial product formed is **α -amino- β -ketoacidipate**, which is rapidly decarboxylated to **δ -aminolevulinic** (Figure 31-6, *top*).

Condensation of two molecules of ALA, catalyzed by cytosolic **ALA dehydratase** (4.2.1.24) forms **porphobilinogen**:

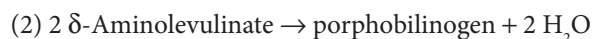

(Figure 31-6, *bottom*). A zinc metalloprotein, ALA dehydratase is sensitive to inhibition by **lead**, as can occur in lead poisoning.

The reaction catalyzed by cytosolic **hydroxymethylbilane synthase** (uroporphyrinogen I synthase, EC 2.5.1.61) forms **hydroxymethylbilane**:

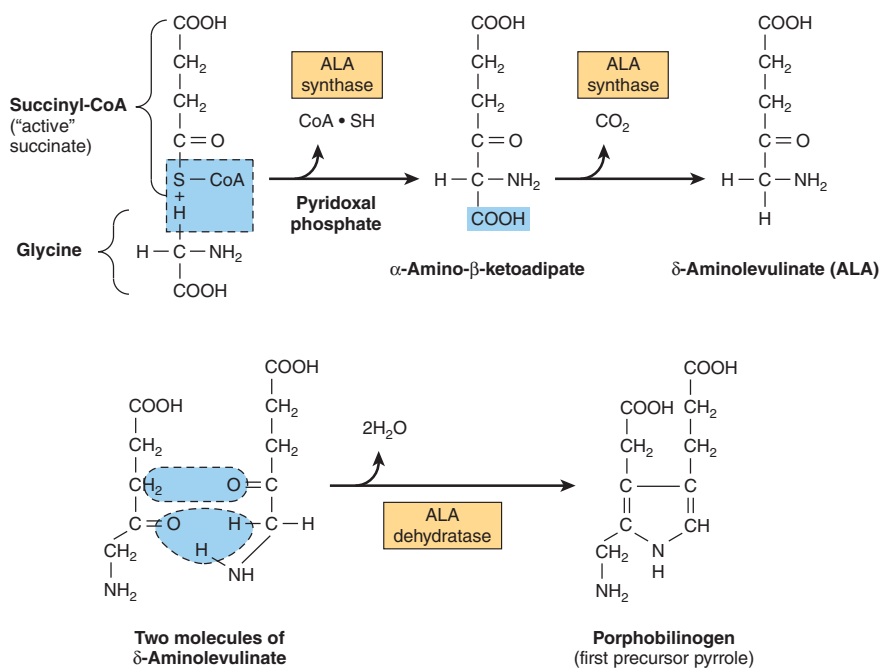
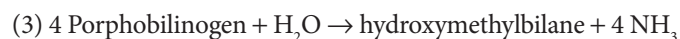

FIGURE 31-6 Biosynthesis of porphobilinogen. ALA synthase is present in mitochondria, ALA dehydratase in the cytosol.

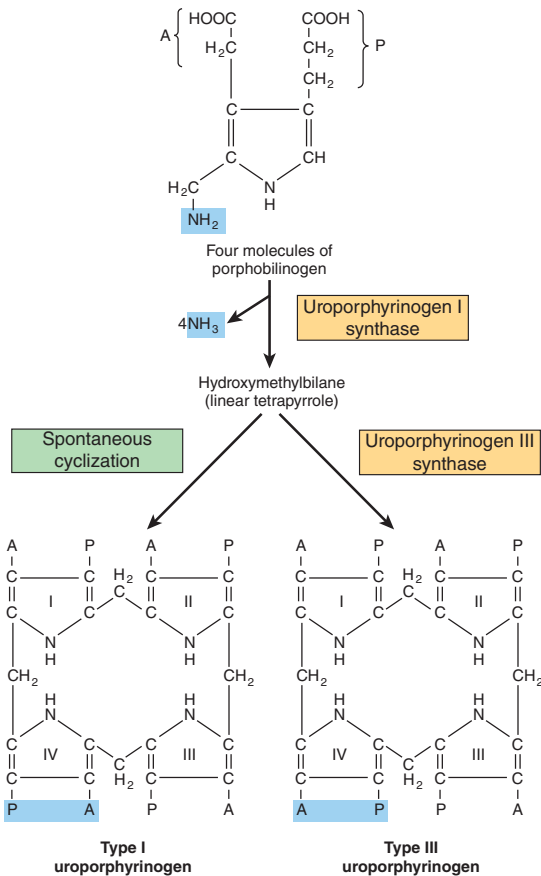
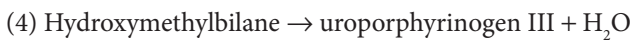

FIGURE 31-7 Conversion of porphobilinogen to uroporphyrinogens. Linearization of porphobilinogen is catalyzed by hydroxymethylbilane synthase (also called uroporphyrinogen synthase I, or porphobilinogen deaminase).

Catalysis involves head-to-tail condensation of four molecules of porphobilinogen to form the linear tetrapyrrole hydroxymethylbilane (**Figure 31-7, center**).

Cyclization of hydroxymethylbilane is catalyzed by cytosolic **uroporphyrinogen III synthase**, EC 4.2.1.75:



forms **uroporphyrinogen III** (**Figure 31-7, right**). Hydroxymethylbilane can also cyclize spontaneously to form **uroporphyrinogen I** (**Figure 31-7, left**), but under normal conditions the uroporphyrinogen formed is almost exclusively the type III isomer. The type-I isomers of porphyrinogens are, however, formed in excess in certain porphyrias. Since the pyrrole rings of these uroporphyrinogens are connected by **methylene** (—CH₂—) rather than by methyne bridges, they do not form a conjugated ring system and thus they, and indeed all porphyrinogens, are **colorless**. They are, however, readily auto-oxidized to their respective **colored porphyrins**.

All four acetate moieties of uroporphyrinogen III next undergo decarboxylation to methyl (M) substituents, forming **coproporphyrinogen III** in a cytosolic reaction catalyzed by **uroporphyrinogen decarboxylase**, EC 4.1.1.37 (**Figures 31-8 and 31-9**):

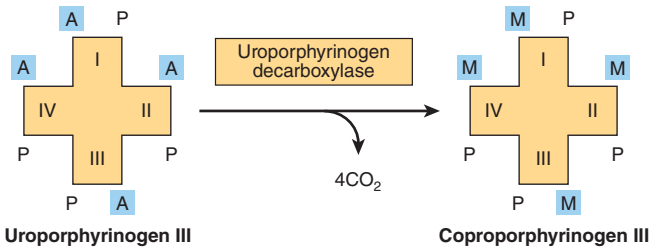

FIGURE 31-8 Decarboxylation of uroporphyrinogen III to coproporphyrinogen III. A = acetyl; M = methyl; P = propionyl.



This decarboxylase can also convert uroporphyrinogen I, if present, to coproporphyrinogen I.

The final three reactions of heme biosynthesis take place in mitochondria. Coproporphyrinogen III enters mitochondria and is converted to **protoporphyrinogen III**, and then to **protoporphyrin III**. These reactions are catalyzed by **coproporphyrinogen oxidase** (EC 1.3.3.3), which decarboxylates and oxidizes the two propionic acid side chains to form **protoporphyrinogen III**:



This oxidase is specific for type III coproporphyrinogen, so type I protoporphyrins generally do not occur in humans.

Protoporphyrinogen III is next oxidized to **protoporphyrin III** in a reaction catalyzed by **protoporphyrinogen oxidase**, EC 1.3.3.4:

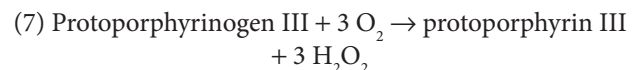

The final step in heme synthesis involves the incorporation of ferrous iron into protoporphyrin III in a reaction catalyzed by **ferrochelatase** (heme synthase, EC 4.99.1.1):



Figure 31-9 summarizes the stages, and their intracellular locations, in the biosynthesis of the porphyrin derivatives from porphobilinogen. For the above reactions, numbers correspond to those in **Figure 31-10** and **Table 31-2**.

ALA Synthase Is the Key Regulatory Enzyme in Hepatic Biosynthesis of Heme

There are two isozymes of **ALA synthase**. ALAS1 is expressed throughout the body; ALAS2 is expressed in erythrocyte precursor cells. The reaction catalyzed by ALA synthase 1 (**Figure 31-6**) is rate-limiting for biosynthesis of heme in liver. It appears that **heme**, probably acting through an apopressor molecule, acts as a **negative regulator** of the synthesis of

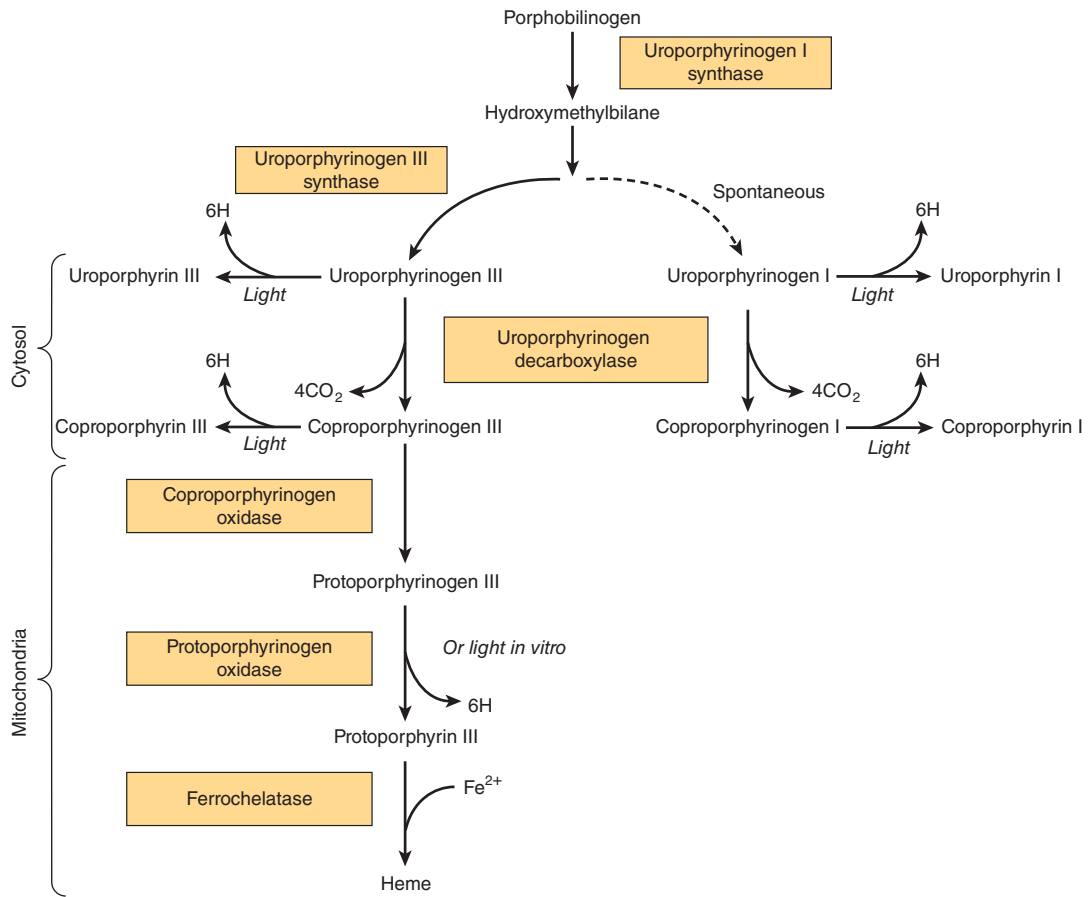

FIGURE 31-9 Steps and cellular location of the reactions in the biosynthesis from porphobilinogen of the indicated porphyrin derivatives, notably heme.

ALAS1 (Figure 31-10). The rate of synthesis of ALAS1 thus increases greatly in the *absence* of heme, but diminishes in its *presence*. Heme also affects translation of the enzyme and its transfer from the cytosol to the mitochondrion. ALAS1 has a short half life, which is typical for an enzyme that catalyzes a rate-limiting reaction.

Many drugs whose metabolism requires the hemoprotein cytochrome P450 increase cytochrome P450 biosynthesis. The resulting depletion of the intracellular heme pool induces synthesis of ALAS1, and the rate of heme synthesis rises to meet metabolic demand. The biosynthesis of ALAS2 is not feedback regulated by heme, and therefore is not induced by these drugs.

PORPHYRINS ARE COLORED & FLUORESCCE

While **porphyrinogens** are colorless, the various **porphyrins** are colored. The **conjugated double bonds** in the pyrrole rings and linking methylene groups of porphyrins (absent in the porphyrinogens) are responsible for their characteristic absorption and fluorescence spectra. The visible and the

ultraviolet spectra of porphyrins and porphyrin derivatives are useful for their identification (Figure 31-11). The sharp absorption band **near 400 nm**, a distinguishing feature shared by all porphyrins, is termed the **Soret band** after its discoverer, the French physicist Charles Soret.

Porphyrins dissolved in strong mineral acids or in organic solvents and illuminated by ultraviolet light emit a strong red **fluorescence**, a property often used to detect small amounts of free porphyrins. The photodynamic properties of porphyrins have suggested their possible use in the treatment of certain types of cancer, a procedure called **cancer phototherapy**. Since tumors often take up more porphyrins than do normal tissues, **hematoporphyrin** or related compounds are administered to a patient with an appropriate tumor. The tumor is then exposed to an **argon laser** to excite the porphyrins, producing cytotoxic effects.

Spectrophotometry Is Used to Detect Porphyrins & Their Precursors

Coproporphyrins and uroporphyrins are excreted in increased amounts in the **porphyrias**. When present in urine or feces, they can be separated by extraction with appropriate

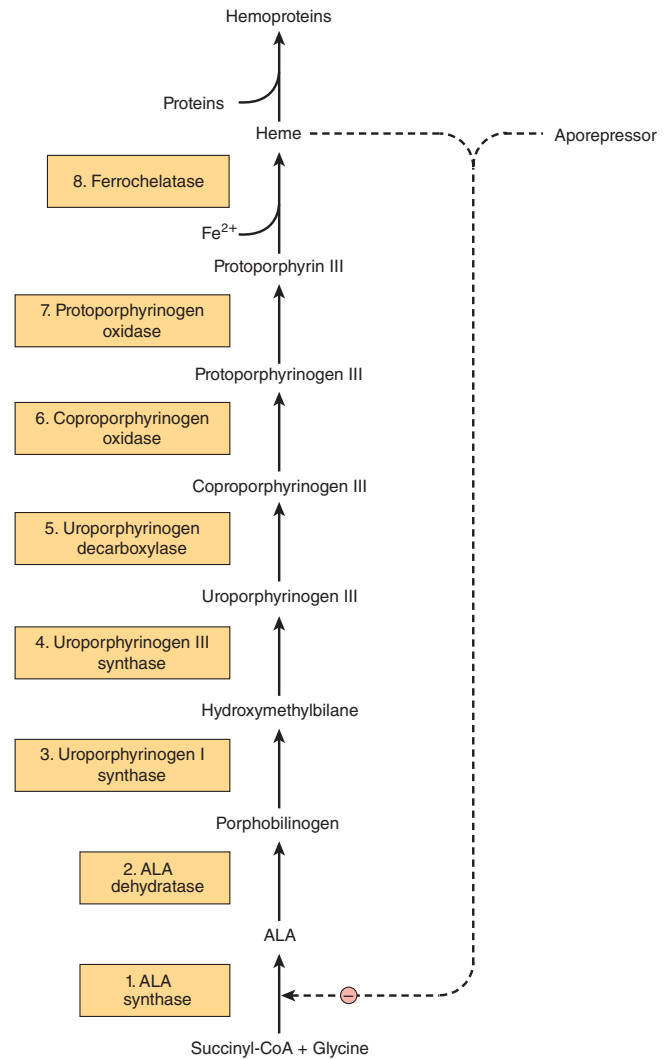

FIGURE 31-10 Intermediates, enzymes and regulation of heme synthesis. The numbers of the enzymes that catalyze the indicated reactions are those used in the accompanying text and in column 1 of Table 31-2. Enzymes 1, 6, 7, and 8 are mitochondrial, but enzymes 2 to 5 are cytosolic. Regulation of hepatic heme synthesis occurs at ALA synthase (ALAS1) by a repression-derepression mechanism mediated by heme and its hypothetical aporepressor. Dashed lines indicate the negative ⊖ regulation by repression. Mutations in the gene encoding enzyme 1 cause X-linked sideroblastic anemia. Mutations in the genes encoding enzymes 2 to 8 give rise to the porphyrias.

TABLE 31-2 Summary of Major Findings in the Porphyrias^a

Enzyme Involved ^b	Type, Class, and OMIM Number	Major Signs and Symptoms	Results of Laboratory Tests
1. ALA synthase 2 (ALAS2), EC 2.3.1.37	X-linked sideroblastic anemia ^c (erythropoietic) (OMIM 301300)	Anemia	Red cell counts and hemoglobin decreased
2. ALA dehydratase EC 4.2.1.24	ALA dehydratase deficiency (hepatic) (OMIM 125270)	Abdominal pain, neuropsychiatric symptoms	Urinary ALA and coproporphyrin III increased
3. Uroporphyrinogen I synthase ^d EC 2.5.1.61	Acute intermittent porphyria (hepatic) (OMIM 176000)	Abdominal pain, neuropsychiatric symptoms	Urinary ALA and PBG ^e increased
4. Uroporphyrinogen III synthase EC 4.2.1.75	Congenital erythropoietic (erythropoietic) (OMIM 263700)	Photosensitivity	Urinary, fecal, and red cell uroporphyrin I increased
5. Uroporphyrinogen decarboxylase EC 4.1.1.37	Porphyria cutanea tarda (hepatic) (OMIM 176100)	Photosensitivity	Urinary uroporphyrin I increased
6. Coproporphyrinogen oxidase EC 1.3.3.3	Hereditary coproporphyria (hepatic) (OMIM 121300)	Photosensitivity, abdominal pain, neuropsychiatric symptoms	Urinary ALA, PBG, and coproporphyrin III and fecal coproporphyrin III increased
7. Protoporphyrinogen oxidase EC 1.3.3.4	Variagate porphyria (hepatic) (OMIM 176200)	Photosensitivity, abdominal pain, neuropsychiatric symptoms	Urinary ALA, PBG, and coproporphyrin III and fecal protoporphyrin IX increased
8. Ferrochelatase EC 4.99.1.1	Protoporphyria (erythropoietic) (OMIM 177000)	Photosensitivity	Fecal and red cell protoporphyrin IX increased

^aOnly the biochemical findings in the active stages of these diseases are listed. Certain biochemical abnormalities are detectable in the latent stages of some of the above conditions. Conditions 3, 5, and 8 are generally the most prevalent porphyrias. Condition 2 is rare.

^bThe numbering of the enzymes in this Table corresponds to that used in Figure 31-10.

^cX-linked sideroblastic anemia is not a porphyria but is included here because ALA synthase is involved.

^dThis enzyme is also called PBG deaminase or hydroxymethylbilane synthase.

^ePBG = porphobilinogen III.

Abbreviations: ALA, δ-aminolevulinic acid; PBG, porphobilinogen.

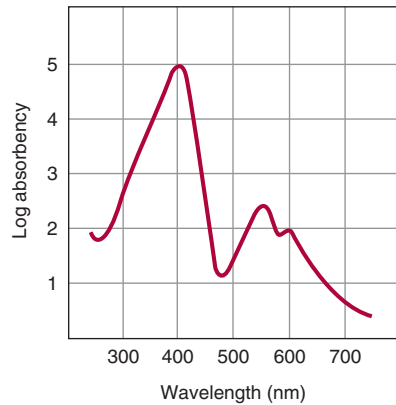

FIGURE 31-11 Absorption spectrum of hematoporphyrin. Shown is the spectrum of an 0.01% solution of hematoporphyrin in 5% HCl.

solvents, then identified and quantified using spectrophotometric methods.

DISORDERS OF HEME BIOSYNTHESIS

Disorders of heme biosynthesis may be genetic or acquired. An example of an acquired defect is lead poisoning. Lead can inactivate ferrochelatase and ALA dehydratase by combining with essential thiol groups. Signs include elevated levels of protoporphyrin in erythrocytes and elevated urinary levels of ALA and coproporphyrin.

Genetic disorders of heme metabolism and of bilirubin metabolism (see below) share the following features with metabolic disorders of urea biosynthesis (see Chapter 28):

1. Similar or identical clinical signs and symptoms can arise from different mutations in genes that encode either a given enzyme or an enzyme that catalyzes a successive reaction.
2. Rational therapy requires an understanding of the biochemistry of the enzyme-catalyzed reactions in both normal and impaired individuals.
3. Identification of the intermediates and side products that accumulate prior to a metabolic block can provide the basis for metabolic screening tests that can implicate the impaired reaction.
4. Definitive diagnosis involves quantitative assay of the activity of the enzyme(s) suspected to be defective.
5. Comparison of the DNA sequence of the gene that encodes a given mutant enzyme to that of the wild-type gene can identify the specific mutation(s) that cause the disease.

The Porphyrrias

The signs and symptoms of porphyria result either from a **deficiency** of intermediates beyond the enzymatic block, or from the **accumulation** of metabolites prior to the block. Table 31-2 lists six major types of **porphyria** that reflect low or

absent activity of enzymes that catalyze reactions 2 through 8 of Figure 31-10. Possibly due to potential lethality, there is no known defect of ALAS1. Individuals with low ALAS2 activity develop anemia, not porphyria (Table 31-2). Porphyria consequent to low activity of ALA dehydratase, termed ALA dehydratase-deficient porphyria, is extremely rare.

Congenital Erythropoietic Porphyria

While most porphyrias are inherited in an **autosomal dominant manner**, congenital erythropoietic porphyria is inherited in a **recessive mode**. The defective enzyme in congenital erythropoietic porphyria is **uroporphyrinogen III synthase**, the catalyst for reaction 4. The photosensitivity and severe disfigurement exhibited by some victims of congenital erythropoietic porphyria has suggested them as prototypes of so-called werewolves.

Acute Intermittent Porphyria

The defective enzyme in acute intermittent porphyria is hydroxymethylbilane synthase (uroporphyrinogen I synthase), the catalyst for reaction 3. ALA and porphobilinogen accumulate in body tissues and fluids (**Figure 31-12**).

Blocks Later in the Pathway

Blocks later in the pathway result in the **accumulation of the porphyrinogens** indicated in Figures 31-10 and 31-12. Their oxidation products, the corresponding porphyrin derivatives, cause **photosensitivity** to visible light of about 400 nm wavelength. Possibly as a result of their excitation and reaction with molecular oxygen, the resulting oxygen radicals injure lysosomes and other subcellular organelles, releasing degradative enzymes that cause variable degrees of skin damage, including scarring.

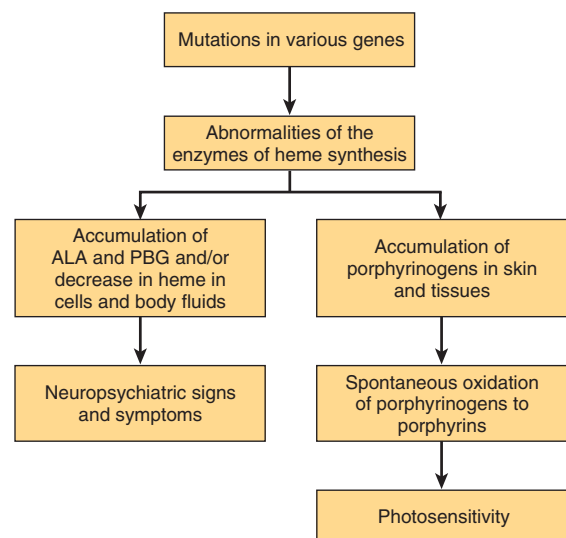

FIGURE 31-12 Biochemical basis of the major signs and symptoms of the porphyrias.

CLASSIFICATION OF PORPHYRIAS

Porphyrias may be termed **erythropoietic** or **hepatic** based on the organs most affected, typically bone marrow and the liver (Table 31–2). Different and variable levels of heme, toxic precursors, or metabolites probably account for why specific porphyrias differentially affect some cell types and organs. Alternatively, porphyrias may be classified as **acute** or **cutaneous** based on their clinical features. The diagnosis of a specific type of porphyria can generally be established from consideration of the clinical and family history, physical examination, and appropriate laboratory tests. Table 31–2 lists the major signs, symptoms, and relevant laboratory finding in the six principal types of porphyria.

Drug-Induced Porphyria

Certain drugs (eg, barbiturates, griseofulvin) induce the production of cytochrome P450. In patients with porphyria, this can precipitate an attack of porphyria by depleting heme levels. The compensating derepression of synthesis of ALAS1 then results in increased levels of potentially harmful heme precursors.

Possible Treatments for Porphyrias

While treatment at the gene level may ultimately become possible, present treatment of porphyrias is essentially symptomatic. This includes avoiding drugs that induce production of cytochrome P450, ingestion of large amounts of carbohydrate, and administration of hematin to repress ALAS1 synthesis to diminish production of harmful heme precursors. Patients exhibiting photosensitivity benefit from sunscreens and possibly from administered β -carotene, which appears to lessen production of free radicals, decreasing photosensitivity.

CATABOLISM OF HEME PRODUCES BILIRUBIN

Human adults normally destroy about 200 billion erythrocytes per day. Thus, a 70-kg human turns over approximately **6 g of hemoglobin** daily. The **globin** is degraded to its constituent amino acids, the released **iron** enters the iron pool, and all products are reused. The iron-free **porphyrin** portion of heme is also degraded, mainly in the reticuloendothelial cells of the liver, spleen, and bone marrow.

The catabolism of heme from all heme proteins is carried out in the **microsomal fraction** of cells by **heme oxygenase**, EC 1.4.99.3. Heme oxygenase synthesis is substrate-inducible, and heme also serves both as a substrate and as a cofactor for the reaction. The iron of the heme that reaches heme oxygenase has usually been oxidized to its **ferric form (hemin)**. Conversion of one mole of heme- Fe^{3+} to biliverdin, carbon monoxide, and Fe^{3+} consumes three moles of O_2 , plus seven electrons provided by NADH and NADPH-cytochrome P450 reductase:

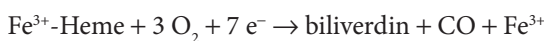

Despite its high affinity for heme- Fe^{2+} (see Chapter 6), the carbon monoxide produced does not severely inhibit heme oxygenase. Birds and amphibians excrete the green colored biliverdin directly. In humans, **biliverdin reductase** (EC 1.3.1.24) reduces the central methylene bridge of biliverdin to a methyl group, producing the yellow pigment **bilirubin**:

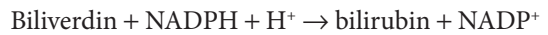

Figure 31–13 summarizes both of the above reactions.

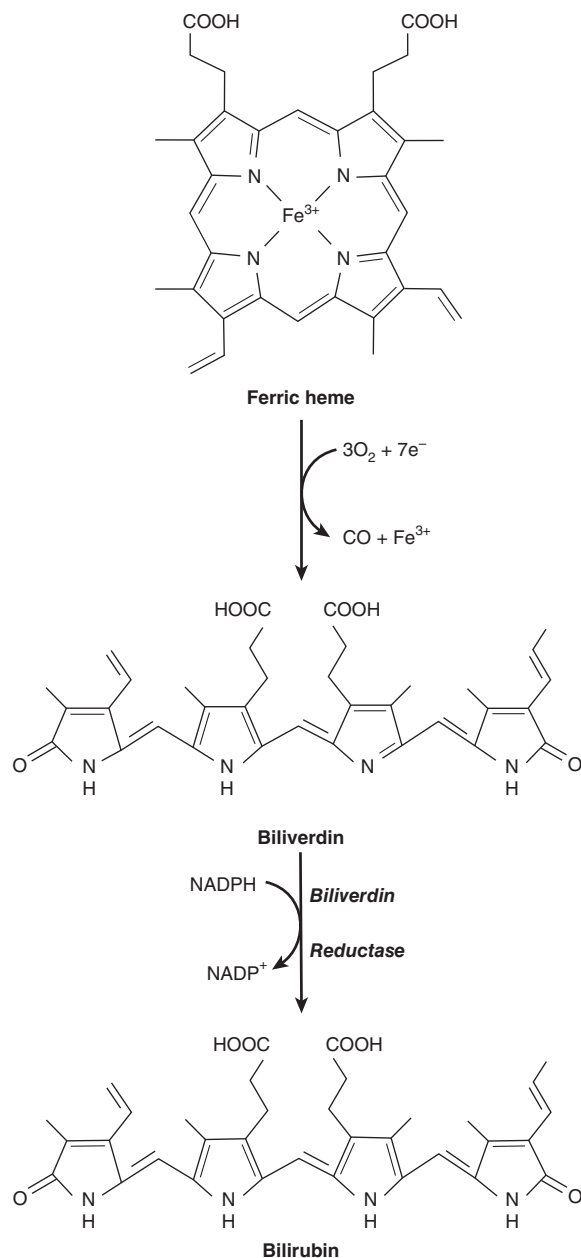

FIGURE 31–13 Conversion of ferric heme to biliverdin, and then to bilirubin. The heme oxygenase system forms biliverdin, which biliverdin reductase reduces to bilirubin. Conversion of one mole of heme- Fe^{3+} to biliverdin, carbon monoxide, and Fe^{3+} consumes three moles of O_2 , plus seven electrons provided by NADH and NADPH-cytochrome P450 reductase.

Since 1 g of hemoglobin yields about 35 mg of bilirubin, **human adults form 250 to 350 mg of bilirubin per day**. This is derived principally from hemoglobin, but also from ineffective erythropoiesis, and from catabolism of other heme proteins.

Conversion of heme to bilirubin by reticuloendothelial cells can be observed visually as the purple color of the heme in a **hematoma** slowly converts to the yellow pigment of bilirubin.

Bilirubin Is Transported to the Liver Bound to Serum Albumin

Bilirubin is only sparingly water-soluble, but bilirubin bound to serum albumin is readily transported to the liver. Albumin appears to have both a high-affinity site and a low-affinity site for bilirubin. The high-affinity site can bind approximately 25 mg of bilirubin/100 mL of plasma. More loosely bound bilirubin can readily be detached and diffuse into tissues, and antibiotics and certain other drugs can compete with and displace bilirubin from albumin's high-affinity site.

Further Metabolism of Bilirubin Occurs Primarily in the Liver

Hepatic catabolism of bilirubin takes place in three stages: uptake by the liver, conjugation with glucuronic acid, and secretion in the bile.

Uptake of Bilirubin by Liver Parenchymal Cells

Bilirubin is removed from albumin and taken up at the sinusoidal surface of hepatocytes by a large capacity, saturable **facilitated transport system**. Even under pathologic conditions, transport does not appear to be rate-limiting for the metabolism of bilirubin. The net uptake of bilirubin depends upon its **removal** by subsequent metabolism. Once internalized, bilirubin binds to cytosolic proteins such as glutathione S-transferase, previously known as a **ligandin**, to prevent bilirubin from reentering the blood stream.

Conjugation of Bilirubin With Glucuronate

Bilirubin is **nonpolar**, and would persist in cells (eg, bound to lipids) if not converted to a more water-soluble form. Bilirubin is converted to a more **polar** molecule by conjugation with glucuronic acid. A bilirubin-specific **UDP-glucosyl transferase** (EC 2.4.1.17) of the endoplasmic reticulum catalyzes stepwise transfer to bilirubin of two glucosyl moieties from UDP-glucuronate:

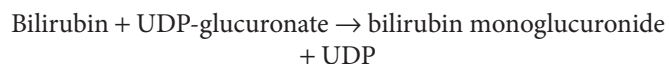

Bilirubin monoglucuronide + UDP-glucuronate \rightarrow bilirubin diglucuronide + UDP (**Figure 31-14**).

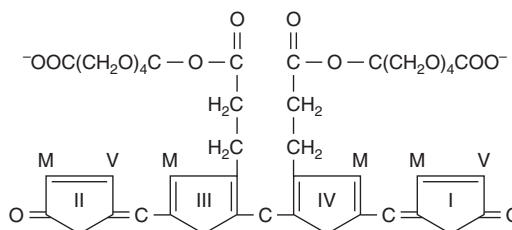

FIGURE 31-14 Structure of bilirubin diglucuronide. Glucuronate moieties are attached via ester bonds to the two propionate groups of bilirubin. Clinically, the diglucuronide is also termed “direct reacting” bilirubin.

Secretion of Bilirubin Into the Bile

Secretion of conjugated bilirubin into the bile occurs by an **active transport** mechanism, which probably is rate-limiting for the entire process of hepatic bilirubin metabolism. The protein involved is a **multispecific organic anion transporter (MOAT)** located in the **plasma membrane** of the bile canaliculi. A member of the family of ATP-binding cassette transporters, MOAT transports a number of organic anions. The hepatic transport of conjugated bilirubin into the bile is **inducible** by the same drugs that can induce the conjugation of bilirubin. Conjugation and excretion of bilirubin thus constitute a coordinated functional unit.

Most of the bilirubin excreted in the bile of mammals is bilirubin diglucuronide. Bilirubin UDP-glucuronosyl transferase activity can be **induced** by several drugs, including phenobarbital. However, when bilirubin conjugates exist abnormally in human plasma (eg, in obstructive jaundice), they are predominantly **monoglucuronides**. **Figure 31-15** summarizes

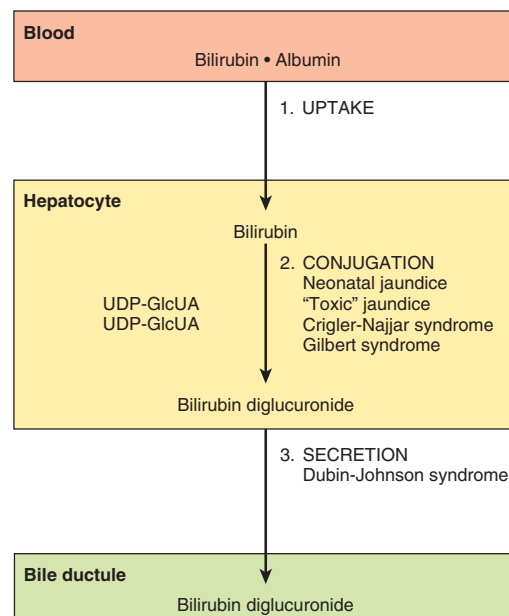

FIGURE 31-15 Diagrammatic representation of the three major processes (uptake, conjugation, and secretion) involved in the transfer of bilirubin from blood to bile. Certain proteins of hepatocytes bind intracellular bilirubin and may prevent its efflux into the blood stream. The processes affected in certain conditions that cause jaundice are also shown.

the three major processes involved in the transfer of bilirubin from blood to bile. Sites that are affected in a number of conditions causing jaundice are also indicated.

Intestinal Bacteria Reduce Conjugated Bilirubin to Urobilinogen

When conjugated bilirubin reaches the terminal ileum and the large intestine, the glucuronosyl moieties are removed by specific bacterial β -glucuronidases (EC 3.2.1.31). Subsequent reduction by the fecal flora forms a group of colorless tetrapyrroles called **urobilinogens**. Small portions of urobilinogens are reabsorbed in the terminal ileum and large intestine and subsequently are reexcreted via the **enterohepatic urobilinogen cycle**. Under abnormal conditions, particularly when excessive bile pigment is formed or when liver disease disrupts this intrahepatic cycle, urobilinogen may also be excreted in the urine. Most of the colorless urobilinogens formed in the colon are **oxidized** there to colored **urobilins** and excreted in the feces. Fecal darkening upon standing in air results from the oxidation of residual urobilinogens to urobilins.

Measurement of Bilirubin in Serum

Quantitation of bilirubin employs a colorimetric method based on the reddish-purple color formed when bilirubin reacts with diazotized sulfanilic acid. An assay conducted in the *absence* of added methanol measures “**direct bilirubin**,” which is **bilirubin glucuronide**. An assay conducted in the *presence* of added methanol measures **total bilirubin**. The *difference* between total bilirubin and direct bilirubin is known as “**indirect bilirubin**,” and is **unconjugated bilirubin**.

HYPERBILIRUBINEMIA CAUSES JAUNDICE

Hyperbilirubinemia, a blood level that exceeds 1 mg of bilirubin per dL (17 $\mu\text{mol/L}$), may result from **production** of more bilirubin than the normal liver can excrete, or from the failure of a damaged liver to **excrete** normal amounts of bilirubin. In the absence of hepatic damage, **obstruction** of the excretory ducts of the liver prevents the excretion of bilirubin, and will also cause hyperbilirubinemia. In all these situations, when the blood concentration reaches 2 to 2.5 mg of bilirubin per dL, it diffuses into the tissues, which turn yellow, a condition termed **jaundice** or **icterus**.

Occurrence of Unconjugated Bilirubin in Blood

Depending on the type of bilirubin present in plasma, hyperbilirubinemia may be classified as **retention hyperbilirubinemia** due to overproduction of bilirubin, or as **regurgitation hyperbilirubinemia**, due to reflux into the bloodstream because of biliary obstruction.

Due to its **hydrophobicity**, only *unconjugated* bilirubin can cross the blood-brain barrier into the central nervous system. Encephalopathy due to hyperbilirubinemia (**kernicterus**)

TABLE 31–3 Some Causes of Unconjugated and Conjugated Hyperbilirubinemia

Unconjugated	Conjugated
Hemolytic anemias	Obstruction of the biliary tree
Neonatal “physiological jaundice”	Dubin–Johnson syndrome
Crigler–Najjar syndromes types I and II	Rotor syndrome
Gilbert syndrome	Liver diseases such as the various types of hepatitis
Toxic hyperbilirubinemia	

These causes are discussed briefly in the text. Common causes of obstruction of the biliary tree are a stone in the common bile duct and cancer of the head of the pancreas. Various liver diseases (eg, the various types of hepatitis) are frequent causes of predominantly conjugated hyperbilirubinemia.

thus occurs only with unconjugated bilirubin, as in retention hyperbilirubinemia. Alternatively, because of its water-solubility, only *conjugated* bilirubin can appear in urine. Accordingly, **choluric jaundice** (choloria is the presence of bile pigments in the urine) occurs only in regurgitation hyperbilirubinemia, and **acholuric jaundice** occurs only in the presence of an excess of unconjugated bilirubin. **Table 31–3** lists some causes of unconjugated and conjugated hyperbilirubinemia. A moderate hyperbilirubinemia accompanies **hemolytic anemias**. Hyperbilirubinemia is usually modest (<4 mg bilirubin per dL; <68 $\mu\text{mol/L}$) despite extensive hemolysis, due to the high capacity of a healthy liver to metabolize bilirubin.

DISORDERS OF BILIRUBIN METABOLISM

Neonatal “Physiologic Jaundice”

The unconjugated hyperbilirubinemia of neonatal “physiologic jaundice” results from accelerated hemolysis and an immature hepatic system for the uptake, conjugation, and secretion of bilirubin. In this transient condition, bilirubin-glucosyltransferase activity, and probably also synthesis of UDP-glucuronate, are reduced. When the plasma concentration of unconjugated bilirubin exceeds that which can be tightly bound by albumin (20–25 mg/dL), bilirubin can penetrate the blood-brain barrier. If left untreated, the resulting **hyperbilirubinemic toxic encephalopathy**, or **kernicterus**, can result in mental retardation. Exposure of jaundiced neonates to blue light (phototherapy) promotes hepatic excretion of unconjugated bilirubin by converting some to derivatives that are excreted in the bile, and phenobarbital, a promoter of bilirubin-metabolism, may be administered.

Defects of Bilirubin UDP-Glucuronosyl Transferase

Glucuronosyl transferases (EC 2.4.1.17) are a large family of enzymes with differing substrate specificities. Most serve to

increase the polarity of various drugs and drug metabolites, and thereby facilitate their excretion. Mutations in the gene that encodes **bilirubin UDP-glucuronosyl transferase** can result in the encoded enzyme having reduced or absent activity. Syndromes whose clinical presentation reflects the severity of the impairment include Gilbert syndrome and two types of Crigler-Najjar syndrome.

Gilbert Syndrome

Providing that about 30% of the bilirubin UDP-glucuronosyl transferase activity is retained in Gilbert syndrome the condition is harmless.

Type I Crigler-Najjar Syndrome

The severe congenital jaundice (over 20 mg bilirubin per dL serum) and accompanying brain damage of type I Crigler-Najjar syndrome reflect the complete absence of hepatic UDP-glucuronosyl transferase activity. Phototherapy reduces plasma bilirubin levels somewhat, but phenobarbital has no beneficial effect. The disease is often fatal within the first 15 months of life.

Type II Crigler-Najjar Syndrome

In type II Crigler-Najjar syndrome, some bilirubin UDP-glucuronosyl transferase activity is retained. This condition consequently has a more benign course than the type I syndrome. Serum bilirubin tends not to exceed 20 mg bilirubin per dL of serum, and patients respond to treatment with large doses of phenobarbital.

Toxic Hyperbilirubinemia

Unconjugated hyperbilirubinemia can result from **toxin-induced liver dysfunction** caused by chloroform, arsphenamines, carbon tetrachloride, acetaminophen, hepatitis virus, cirrhosis, or *Amanita* mushroom poisoning. These acquired disorders involve hepatic parenchymal cell damage, which impairs bilirubin conjugation.

Obstruction in the Biliary Tree Is the Most Common Cause of Conjugated Hyperbilirubinemia

Conjugated hyperbilirubinemia commonly results from blockage of the hepatic or common bile ducts, most often due to a **gallstone** or to **cancer of the head of the pancreas** (Figure 31–16). Bilirubin diglucuronide that cannot be excreted regurgitates into the hepatic veins and lymphatics, conjugated bilirubin appears in the blood and urine (**choluric jaundice**), and the stools typically are a pale color.

The term **cholestatic jaundice** include all cases of extrahepatic obstructive jaundice and also jaundice that exhibit conjugated hyperbilirubinemia due to micro-obstruction of intrahepatic biliary ductules by swollen, damaged hepatocytes, such as may occur in infectious hepatitis.

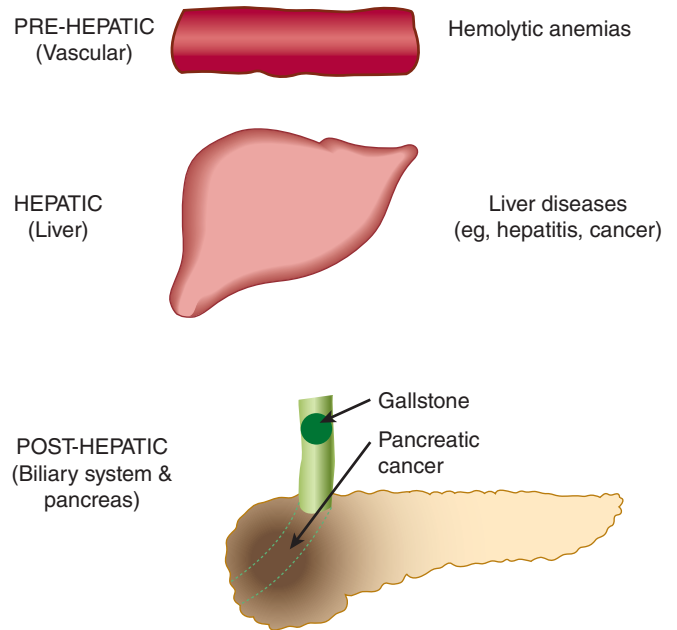

FIGURE 31–16 Diagrammatic representation of some major causes of jaundice. **Prehepatic jaundice** indicates events in the blood stream; the major cause would be various forms of hemolytic anemia (see Chapter 53). **Hepatic jaundice** signifies events in the liver, such as the various types of hepatitis or other forms of liver disease (eg, cancer). **Posthepatic jaundice** refers to events in the biliary tree, for which the major causes are obstruction of the common bile duct by a gallstone (biliary calculus) or by cancer of the head of the pancreas.

Dubin-Johnson Syndrome

This benign autosomal recessive disorder consists of **conjugated hyperbilirubinemia** in childhood or during adult life. The hyperbilirubinemia is caused by mutations in the gene encoding the protein involved in the **secretion** of conjugated bilirubin into bile.

Some Conjugated Bilirubin Can Bind Covalently to Albumin

When levels of conjugated bilirubin remain high in plasma, a fraction can bind covalently to albumin. This fraction, termed **δ -bilirubin**, has a **longer half-life** in plasma than does conventional conjugated bilirubin, and remains elevated during recovery from obstructive jaundice. Some patients therefore continue to appear jaundiced even after the circulating conjugated bilirubin level has returned to normal.

Urinary Urobilinogen & Bilirubin Are Clinical Indicators

In **complete obstruction of the bile duct** bilirubin has no access to the intestine for conversion to urobilinogen, so no urobilinogen is present in the urine. The presence of conjugated bilirubin in the urine without urobilinogen suggests intrahepatic or posthepatic obstructive jaundice.

TABLE 31-4 Laboratory Results in Normal Patients and Patients With Three Different Causes of Jaundice

Condition	Serum Bilirubin	Urine Urobilinogen	Urine Bilirubin	Fecal Urobilinogen
Normal	Direct: 0.1-0.4 mg/dL Indirect: 0.2-0.7 mg/dL	0-4 mg/24 h	Absent	40-280 mg/24 h
Hemolytic anemia	↑Indirect	Increased	Absent	Increased
Hepatitis	↑Direct and indirect	Decreased if micro-obstruction is present	Present if micro-obstruction occurs	Decreased
Obstructive jaundice ^a	↑Direct	Absent	Present	Trace to absent

^aThe most common causes of obstructive (posthepatic) jaundice are cancer of the head of the pancreas and a gallstone lodged in the common bile duct. The presence of bilirubin in the urine is sometimes referred to as choluria—therefore, hepatitis and obstruction of the common bile duct cause choluric jaundice, whereas the jaundice of hemolytic anemia is referred to as acholuric. The laboratory results in patients with hepatitis are variable, depending on the extent of damage to parenchymal cells and the extent of micro-obstruction to bile ductules. Serum levels of **alanine aminotransferase** and **aspartate aminotransferase** are usually markedly elevated in hepatitis, whereas serum levels of **alkaline phosphatase** are elevated in obstructive liver disease.

In **jaundice secondary to hemolysis**, the increased production of bilirubin leads to increased production of **urobilinogen**, which appears in the urine in large amounts. Bilirubin is not usually found in the urine in hemolytic jaundice, so the combination of increased urobilinogen and absence of bilirubin is suggestive of hemolytic jaundice. Increased blood destruction from any cause brings about an increase in urine urobilinogen.

Table 31-4 summarizes laboratory results obtained in patients with jaundice due to prehepatic, hepatic, or post hepatic causes: **hemolytic anemia** (prehepatic), **hepatitis** (hepatic), and **obstruction of the common bile duct** (posthepatic). See Figure 31-16. Laboratory tests on **blood** (evaluation of the possibility of a hemolytic anemia and measurement of prothrombin time) and on **serum** (eg, electrophoresis of proteins; alkaline phosphatase and alanine aminotransferase and aspartate aminotransferase activities) also help to distinguish between prehepatic, hepatic and posthepatic causes of jaundice.

SUMMARY

- The heme of hemoproteins such as hemoglobin and the cytochromes is an iron-containing porphyrin consisting of four pyrrole rings joined by methyne bridges.
- A total of eight methyl, vinyl, and propionyl substituents on the four pyrrole rings of heme are arranged in a specific sequence. The metal ion (Fe^{2+} in hemoglobin; Mg^{2+} in chlorophyll) is linked to the four nitrogen atoms of the pyrrole rings.
- Biosynthesis of the heme ring involves eight enzyme-catalyzed reactions. Some of these reactions occur in mitochondria, others in the cytosol.
- Synthesis of heme commences with the condensation of succinyl-CoA and glycine to form δ -aminolevulinic acid (ALA). This reaction is catalyzed by ALA synthase 1 (ALAS1), the regulatory enzyme of heme biosynthesis.
- Synthesis of ALAS1 increases in response to a low level of available heme. Certain drugs (eg, phenobarbital) indirectly trigger enhanced synthesis of ALAS1 by promoting synthesis of cytochrome P450, which depletes the heme pool. A second ALA synthase, ALAS2, is not regulated by heme levels or by drugs that promote synthesis of cytochrome P450.
- Genetic abnormalities of seven of the eight enzymes of heme biosynthesis result in inherited porphyrias. Erythrocytes and liver are the major sites of expression of the porphyrias. Photosensitivity and neurologic problems are common complaints. Intake of certain toxins (eg, lead) can cause acquired porphyrias. Increased amounts of porphyrins or their precursors can be detected in blood and urine, facilitating diagnosis.
- Catabolism of the heme ring, initiated by the mitochondrial enzyme heme oxygenase, produces the linear tetrapyrrole, biliverdin. Subsequent reduction of biliverdin in the cytosol forms bilirubin.
- Bilirubin binds to albumin for transport from peripheral tissues to the liver, where it is taken up by hepatocytes. The iron of heme is released and reutilized.
- The water solubility of bilirubin is increased by the addition of two moles of the highly polar glucuronosyl moiety, derived from UDP-glucuronate, per mole of bilirubin. Attachment of the glucuronosyl moieties is catalyzed by bilirubin UDP-glucuronosyl transferase, one of a large family of enzymes with differing substrate specificity that increase the polarity of various drugs and their metabolites, thereby facilitating their excretion.
- Mutations in the encoding gene result in reduced or absent activity of bilirubin UDP-glucuronosyl transferase activity. Clinical presentations that reflect the severity of the mutation(s) include Gilbert syndrome and two types of Crigler-Najjar syndrome, conditions whose severity depends on the extent of remaining enzyme activity.
- Following secretion of bilirubin from the bile into the gut, bacterial enzymes convert bilirubin to urobilinogen and urobilin, which are excreted in the feces and urine.
- Colorimetric measurement of bilirubin employs the color formed when bilirubin reacts with diazotized sulfanilic acid. Assays conducted in the *absence* of added methanol measure “direct bilirubin” (ie, bilirubin glucuronide). Assays conducted in the *presence* of added methanol measure total bilirubin. The difference between total bilirubin and direct bilirubin, termed “indirect bilirubin,” is unconjugated bilirubin.

- Jaundice results from an elevated level of plasma bilirubin. The causes of jaundice can be distinguished as prehepatic (eg, hemolytic anemias), hepatic (eg, hepatitis), or posthepatic (eg, obstruction of the common bile duct). Measurements of plasma total and nonconjugated bilirubin, of urinary urobilinogen and bilirubin, of the activity of certain serum enzymes, and the analysis of stool samples help distinguish between the causes of jaundice.

REFERENCES

- Bowman SE, Bren KL: The chemistry and biochemistry of heme c: functional bases for covalent attachment. *Nat Prod Rep* 2008;25:1118.
- Blouin JM, Duchartre Y, Costet P, et al: Therapeutic potential of proteasome inhibitors in congenital erythropoietic porphyria. *Proc Natl Acad Sci USA* 2013;110:18238.
- Deacon AC, Whatley SD, Elder GH: Porphyrins and disorders of porphyrin metabolism. In: *Tietz Textbook of Clinical Chemistry and Molecular Diagnostics*, 4th ed. Ch. 32. Burtis CA, Ashwood ER, Bruns DE (editors). Elsevier Saunders, 2006.
- Desnick RJ, Astrin KH: The porphyrias. In: *Harrison's Principles of Internal Medicine*, 17th ed. Fauci AS et al (editors). Ch. 352. McGraw-Hill, 2008.
- Kim DH, Jin YH: Intestinal bacterial beta-glucuronidase activity of patients with colon cancer. *Arch Pharm Res* 2001;24:564.
- Leroyer A, Leleu B, Dehon B, et al: Influence of delta-aminolevulinic acid dehydratase gene polymorphism on selected lead exposure biomarkers in a cohort of ex-smelter workers. *J Toxicol Environ Health A* 2013;76:895.
- Li T, Bonkovsky HL, Guo J-T: Structural analysis of heme proteins: implications for design and prediction. *BMC Structural Biology* 2011;11:13.
- Sticova E, Jirsa M: New insights in bilirubin metabolism and their clinical implications. *World J Gastroenterol* 2013;19:6398.
- Unno M, Matsui T, Ikeda-Saito, M: Structure and catalytic mechanism of heme oxygenase. *Nat Prod Rep* 2007;24:553.
- van de Steeg E, Stránecký V, Hartmannová H, et al: Complete OATP1B1 and OATP1B3 deficiency causes human Rotor syndrome by interrupting conjugated bilirubin reuptake into the liver. *J Clin Invest* 2012;122:519.
- Watchko JF, Tiribelli C: Bilirubin-induced neurologic damage: mechanisms and management approaches. *N Engl J Med* 2013;369:2021
- Wolkoff AW: The hyperbilirubinemias. In: *Harrison's Principles of Internal Medicine*, 17th ed. Fauci AS et al (editors). Ch. 297. McGraw-Hill, 2008.
- Yoshida T, Migita CT: Mechanism of heme degradation by heme oxygenase. *J Inorg Biochem* 2000;82:33.

Exam Questions

Section VI – Metabolism of Proteins & Amino Acids

- Select the one of the following statements that is NOT CORRECT:
 - Δ^1 -Pyrroline-5-carboxylate is an intermediate both in the biosynthesis and in the catabolism of L-proline.
 - Human tissues can form dietarily nonessential amino acids from amphibolic intermediates or from dietarily essential amino acids.
 - Human liver tissue can form serine from the glycolytic intermediate 3-phosphoglycerate.
 - The reaction catalyzed by phenylalanine hydroxylase interconverts phenylalanine and tyrosine.
 - The reducing power of tetrahydrobiopterin derives ultimately from NADPH.
- Identify the metabolite that does NOT serve as a precursor of a dietarily essential amino acid:
 - α -Ketoglutarate
 - 3-Phosphoglycerate
 - Glutamate
 - Aspartate
 - Histamine
- Select the one of the following statements that is NOT CORRECT:
 - Selenocysteine is present at the active sites of certain human enzymes.
 - Selenocysteine is inserted into proteins by a posttranslational process.
 - Transamination of dietary α -keto acids can replace the dietary essential amino acids leucine, isoleucine, and valine.
 - Conversion of peptidyl proline to peptidyl-4-hydroxyproline is accompanied by the incorporation of oxygen into succinate.
 - Serine and glycine are interconverted in a single reaction in which tetrahydrofolate derivatives participate.
- Select the CORRECT answer:

The first reaction in the degradation of most of the protein amino acids involves the participation of:

 - NAD⁺
 - Thiamine pyrophosphate (TPP)
 - Pyridoxal phosphate
 - FAD
 - NAD⁺ and TPP
- Identify the amino acid that is the major contributor to the transport of nitrogen destined for excretion as urea:
 - Alanine
 - Glutamine
 - Glycine
 - Lysine
 - Ornithine
- Select the one of the following statements that is NOT CORRECT:
 - Angelman syndrome is associated with a defective ubiquitin E3 ligase.
 - Following a protein-rich meal, the splanchnic tissues release predominantly branched-chain amino acids, which are taken up by peripheral muscle tissue.
 - The rate of hepatic gluconeogenesis from glutamine exceeds that of any other amino acid.
 - The L- α -amino oxidase-catalyzed conversion of an α -amino acid to its corresponding α -keto acid is accompanied by the release of NH₄⁺.
 - Similar or even identical signs and symptoms can be associated with different mutations of the gene that encodes a given enzyme.
- Select the one of the following statements that is NOT CORRECT:
 - PEST sequences target some proteins for rapid degradation.
 - ATP and ubiquitin typically participate in the degradation of membrane-associated proteins and other proteins with long half-lives.
 - Ubiquitin molecules are attached to target proteins via non- α peptide bonds.
 - The discoverers of ubiquitin-mediated protein degradation received a Nobel Prize.
 - Degradation of ubiquitin-tagged proteins takes place in the proteasome, a multi-subunit macromolecule present in all eukaryotes.
- For metabolic disorders of the urea cycle, which statement is NOT CORRECT:
 - Ammonia intoxication is most severe when the metabolic block in the urea cycle occurs prior to the reaction catalyzed by argininosuccinate synthase.
 - Clinical symptoms include mental retardation and the avoidance of protein-rich foods.
 - Clinical signs can include acidosis.
 - Aspartate provides the second nitrogen of argininosuccinate.
 - Dietary management focuses on a low-protein diet ingested as frequent small meals.
- Select the one of the following statements that is NOT CORRECT:
 - One metabolic function of glutamine is to sequester nitrogen in a nontoxic form.
 - Liver glutamate dehydrogenase is allosterically inhibited by ATP and activated by ADP.
 - Urea is formed both from absorbed ammonia produced by enteric bacteria and from ammonia generated by tissue metabolic activity.
 - The concerted action of glutamate dehydrogenase and glutamate aminotransferase may be termed transdeamination.
 - Fumarate generated during biosynthesis of argininosuccinate ultimately forms oxaloacetate in reactions in mitochondria catalyzed successively by fumarase and malate dehydrogenase.

10. Select the one of the following statements that is NOT CORRECT:
- Threonine provides the thioethanol moiety for biosynthesis of coenzyme A.
 - Histamine arises by decarboxylation of histidine.
 - Ornithine serves as a precursor of both spermine and spermidine.
 - Serotonin and melatonin are metabolites of tryptophan.
 - Glycine, arginine, and methionine each contribute atoms for biosynthesis of creatine.
11. Select the one of the following statements that is NOT CORRECT:
- Excreted creatinine is a function of muscle mass, and can be used to determine whether a patient has provided a complete 24-hour urine specimen.
 - Many drugs and drug catabolites are excreted in urine as glycine conjugates.
 - The major nonprotein metabolic fate of methionine is conversion to *S*-adenosylmethionine.
 - The concentration of histamine in brain hypothalamus exhibits a circadian rhythm.
 - Decarboxylation of glutamine forms the inhibitory neurotransmitter GABA (γ -aminobutyrate).
12. What distinguishes the routes by which each of the following amino acids appears in human proteins:
- 5-Hydroxylysine
 γ -Carboxyglutamate
Selenocysteine
13. What evolutionary advantage might be gained by the fact that certain amino acids are *dietarily* essential for human subjects?
14. What explanation can you offer to explain that metabolic defects that result in the complete absence of the activity of glutamate dehydrogenase have not been detected?
15. Which of the following is NOT a hemoprotein?
- Myoglobin
 - Cytochrome *c*
 - Catalase
 - Cytochrome P450
 - Albumin
16. A 30-year-old man presented at clinic with a history of intermittent abdominal pain and episodes of confusion and psychiatric problems. Laboratory tests revealed increases of urinary δ -aminolevulinate and porphobilinogen. Mutational analysis revealed a mutation in the gene for uroporphyrinogen I synthase (porphobilinogen deaminase). The probable diagnosis was:
- Acute intermittent porphyria.
 - X-linked sideroblastic anemia.
 - Congenital erythropoietic porphyria.
 - Porphyria cutanea tarda.
 - Variegate porphyria.
17. Select the one of the following statements that is NOT CORRECT:
- Bilirubin is a cyclic tetrapyrrole.
 - Albumin-bound bilirubin is transported to the liver.
 - High levels of bilirubin can cause damage to the brains of newborn infants.
 - Bilirubin contains methyl and vinyl groups.
 - Bilirubin does not contain iron.
18. A 62-year-old female presented at clinic with intense jaundice, steadily increasing over the preceding 3 months. She gave a history of severe upper abdominal pain, radiating to the back, and had lost considerable weight. She had noted that her stools had been very pale for some time. Lab tests revealed a very high level of direct bilirubin, and also elevated urinary bilirubin. The plasma level of alanine aminotransferase (ALT) was only slightly elevated, whereas the level of alkaline phosphatase was markedly elevated. Abdominal ultrasonography revealed no evidence of gallstones. Of the following, which is the most likely diagnosis?
- Gilbert syndrome
 - Hemolytic anemia
 - Type 1 Crigler-Najjar syndrome
 - Carcinoma of the pancreas
 - Infectious hepatitis
19. Clinical laboratories typically use diazotized sulfanilic acid to measure serum bilirubin and its derivatives. What is the physical basis that permits the laboratory to report results to the physician in terms of these two forms of bilirubin?
20. What signals the synthesis of heme to take place?

This page intentionally left blank

Structure, Function, & Replication of Informational Macromolecules

Nucleotides

Victor W. Rodwell, PhD

OBJECTIVES

After studying this chapter, you should be able to:

- Write structural formulas to represent the amino- and oxo-tautomers of a purine and of a pyrimidine and state which tautomer predominates under physiologic conditions.
- Reproduce the structural formulas for the principal nucleotides present in DNA and in RNA and the less common nucleotides 5-methylcytosine, 5-hydroxymethylcytosine, and pseudouridine (ψ).
- Represent D-ribose or 2-deoxy-D-ribose linked as either a *syn* or an *anti* conformer to a purine, name the bond between the sugar and the base, and indicate which conformer predominates under most physiologic conditions.
- Number the C and N atoms of a pyrimidine ribonucleoside and of a purine deoxyribonucleoside, including using a primed numeral for C atoms of the sugars.
- Compare the phosphoryl group transfer potential of each phosphoryl group of a nucleoside triphosphate.
- Outline the physiologic roles of the cyclic phosphodiester cAMP and cGMP.
- Appreciate that polynucleotides are directional macromolecules composed of mononucleotides linked by 3' \rightarrow 5'-phosphodiester bonds.
- Be familiar with the abbreviated representations of polynucleotide structures such as pTpGpT or TGCATCA, for which the 5'-end is always shown at the left and all phosphodiester bonds are 3' \rightarrow 5'.
- For specific synthetic analogs of purine and pyrimidine bases and their derivatives that have served as anticancer drugs, indicate in what ways these compounds inhibit metabolism.

BIOMEDICAL IMPORTANCE

In addition to serving as precursors of nucleic acids, purine and pyrimidine nucleotides participate in metabolic functions as diverse as energy metabolism, protein synthesis, regulation of enzyme activity, and signal transduction. When linked to

vitamins or vitamin derivatives, nucleotides form a portion of many coenzymes. As the principal donors and acceptors of phosphoryl groups in metabolism, nucleoside tri- and diphosphates such as ATP and ADP are the principal players in the energy transductions that accompany metabolic interconversions and oxidative phosphorylation. Linked to sugars or lipids, nucleosides

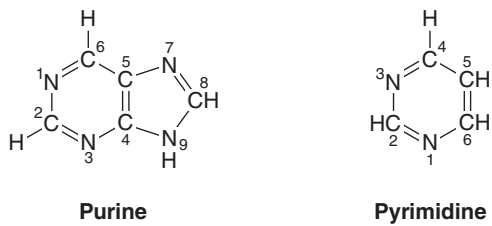

FIGURE 32-1 Purine and pyrimidine. The atoms are numbered according to the international system.

constitute key biosynthetic intermediates. The sugar derivatives UDP-glucose and UDP-galactose participate in sugar interconversions and in the biosynthesis of starch and glycogen. Similarly, nucleoside-lipid derivatives such as CDP-acylglycerol are intermediates in lipid biosynthesis. Roles that nucleotides perform in metabolic regulation include ATP-dependent phosphorylation of key metabolic enzymes, allosteric regulation of enzymes by ATP, ADP, AMP, and CTP, and control by ADP of the rate of oxidative phosphorylation. The cyclic nucleotides cAMP and cGMP serve as the second messengers in hormonally regulated events, and GTP and GDP play key roles in the cascade of events that characterize signal transduction pathways. In addition to the central roles that nucleotides play in metabolism, their medical applications include the use of synthetic purine and pyrimidine analogs that contain halogens, thiols, or additional nitrogen atoms in the chemotherapy of cancer and AIDS, and as suppressors of the immune response during organ transplantation.

CHEMISTRY OF PURINES, PYRIMIDINES, NUCLEOSIDES, & NUCLEOTIDES

Purines & Pyrimidines Are Heterocyclic Compounds

Purines and pyrimidines are nitrogen-containing **heterocycles**, cyclic structures that contain, in addition to carbon, other (hetero) atoms such as nitrogen. Note that the smaller pyrimidine molecule has the *longer* name and the larger purine molecule the *shorter* name, and that their six-atom rings are numbered in opposite directions (**Figure 32-1**).

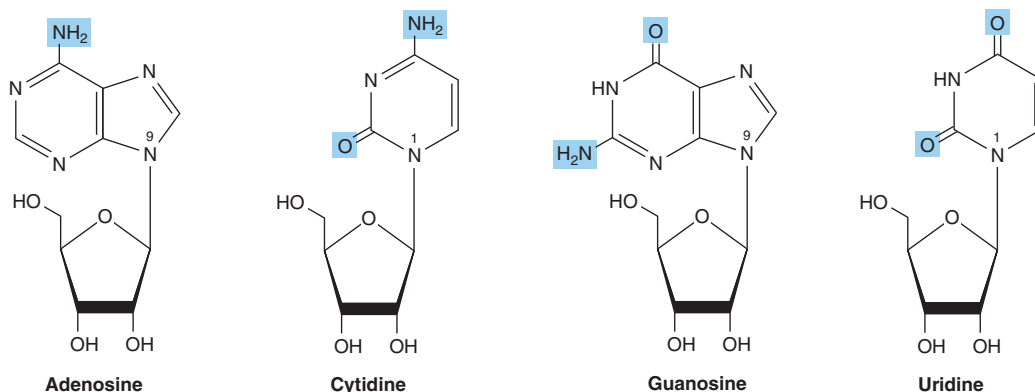

FIGURE 32-3 Ribonucleosides, drawn as the *syn* conformers.



FIGURE 32-2 Tautomerism of the oxo and amino functional groups of purines and pyrimidines.

Purines or pyrimidines with an —NH₂ group are weak bases (pK_a values 3-4), although the proton present at low pH is associated, not as one might expect with the exocyclic amino group, but with a ring nitrogen, typically N1 of adenine, N7 of guanine, and N3 of cytosine. The planar character of purines and pyrimidines facilitates their close association, or “stacking,” that stabilizes double-stranded DNA (see Chapter 34). The oxo and amino groups of purines and pyrimidines exhibit keto-enol and amine-imine **tautomerism** (**Figure 32-2**), although physiologic conditions strongly favor the amino and oxo forms.

Nucleosides Are *N*-Glycosides

Nucleosides are derivatives of purines and pyrimidines that have a sugar linked to a ring nitrogen of a purine or pyrimidine. Numerals with a prime (eg, 2' or 3') distinguish atoms of the sugar from those of the heterocycle. The sugar in **ribonucleosides** is D-ribose, and in **deoxyribonucleosides** is 2-deoxy-D-ribose. Both sugars are linked to the heterocycle by a **β -N-glycosidic bond**, almost always to the *N*-1 of a pyrimidine or to *N*-9 of a purine (**Figure 32-3**).

Nucleotides Are Phosphorylated Nucleosides

Mononucleotides are nucleosides with a phosphoryl group esterified to a hydroxyl group of the sugar. The 3'- and 5'-nucleotides are nucleosides with a phosphoryl group on the 3'- or 5'-hydroxyl group of the sugar, respectively. Since most nucleotides are 5'-, the prefix “5'-” usually is omitted when naming them. UMP and dAMP thus represent nucleotides with a phosphoryl group on C-5 of the pentose. Additional phosphoryl groups, ligated by **acid anhydride bonds** to the phosphoryl group of a mononucleotide, form **nucleoside diphosphates** and **triphosphates** (**Figure 32-4**).

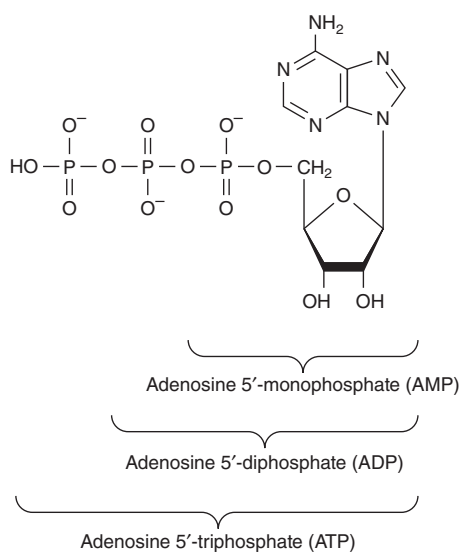

FIGURE 32-4 ATP, its diphosphate, and its monophosphate.

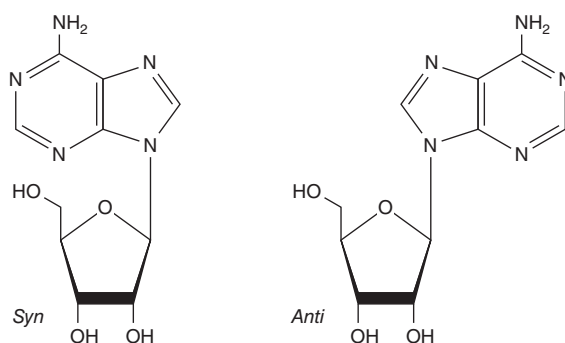

FIGURE 32-5 The *syn* and *anti* conformers of adenosine differ with respect to orientation about the *N*-glycosidic bond.

Heterocyclic *N*-Glycosides Exist as *Syn* and *Anti* Conformers

Steric hindrance by the heterocycle dictates that there is no freedom of rotation about the β -*N*-glycosidic bond of nucleosides or nucleotides. Both therefore exist as noninterconvertible ***syn* or *anti* conformers** (Figure 32-5). While both *syn* and *anti* conformers occur in nature, the *anti* conformers predominate.

Table 32-1 lists the major purines and pyrimidines and their nucleoside and nucleotide derivatives. Single-letter

TABLE 32-1 Purine Bases, Ribonucleosides, and Ribonucleotides

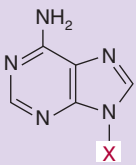
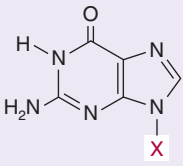
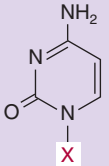
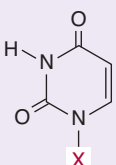
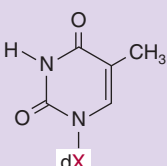
Purine or Pyrimidine	X = H	X = Ribose	X = Ribose Phosphate
	Adenine	Adenosine	Adenosine monophosphate (AMP)
	Guanine	Guanosine	Guanosine monophosphate (GMP)
	Cytosine	Cytidine	Cytidine monophosphate (CMP)
	Uracil	Uridine	Uridine monophosphate (UMP)
	Thymine	Thymidine	Thymidine monophosphate (TMP)

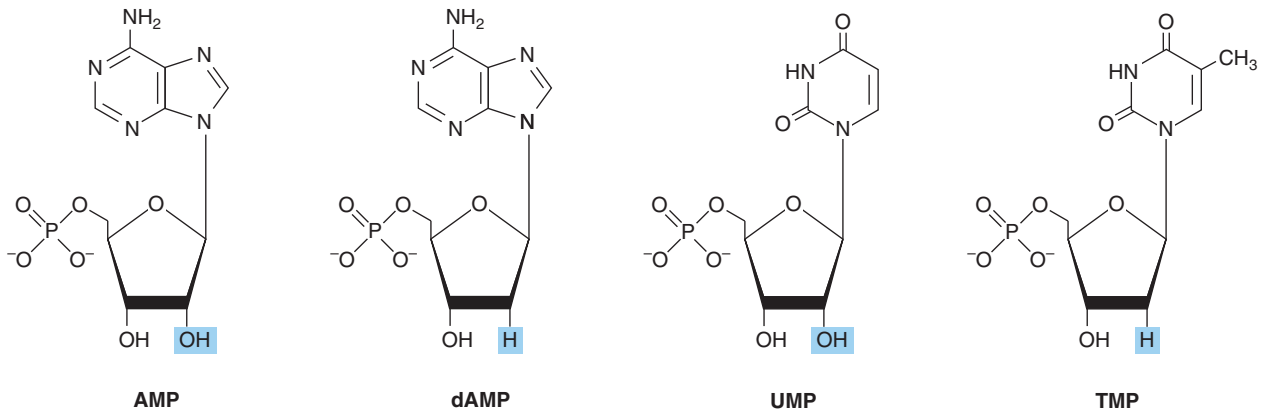

FIGURE 32-6 Structures of AMP, dAMP, UMP, and TMP.

abbreviations are used to identify adenine (A), guanine (G), cytosine (C), thymine (T), and uracil (U), whether free or present in nucleosides or nucleotides. The prefix “d” (deoxy) indicates that the sugar is 2′-deoxy-D-ribose (eg, in dATP) (Figure 32-6).

Modification of Polynucleotides Can Generate Additional Structures

Small quantities of additional purines and pyrimidines occur in DNA and RNAs. Examples include 5-methylcytosine of bacterial and human DNA, 5-hydroxymethylcytosine of bacterial and viral nucleic acids, and mono- and the di-*N*-methylated adenine and guanine of mammalian messenger RNAs (Figure 32-7) that function in oligonucleotide recognition and in regulating the half-lives of RNAs. Free heterocyclic bases include hypoxanthine, xanthine, and uric acid (Figure 32-8), intermediates in the catabolism of adenine and guanine (see Chapter 33). Methylated heterocycles of plants

include the xanthine derivatives caffeine of coffee, theophylline of tea, and theobromine of cocoa (Figure 32-9).

Nucleotides Are Polyfunctional Acids

The primary and secondary phosphoryl groups of nucleosides have pK_a values of about 1.0 and 6.2, respectively. Nucleotides therefore bear significant negative charge at physiologic pH. The pK_a values of the secondary phosphoryl groups are such that they can serve either as proton donors or as proton acceptors at pH values approximately two or more units above or below neutrality.

Nucleotides Absorb Ultraviolet Light

The conjugated double bonds of purine and pyrimidine derivatives absorb ultraviolet light. While their spectra are pH-dependent, at pH 7.0 all the common nucleotides absorb light at a wavelength close to 260 nm. The concentration of nucleotides and nucleic acids thus often is expressed in terms

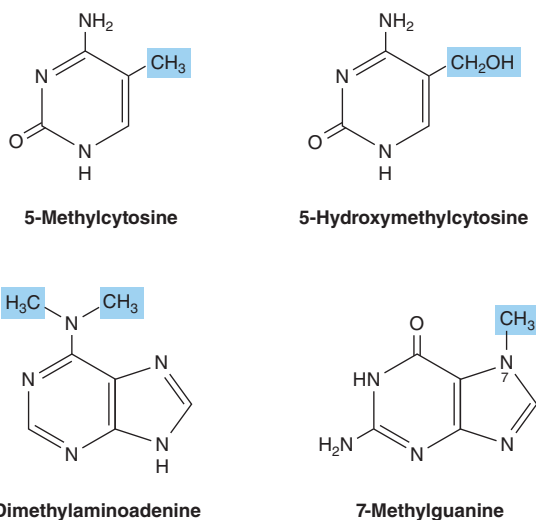

FIGURE 32-7 Four uncommon naturally occurring pyrimidines and purines.

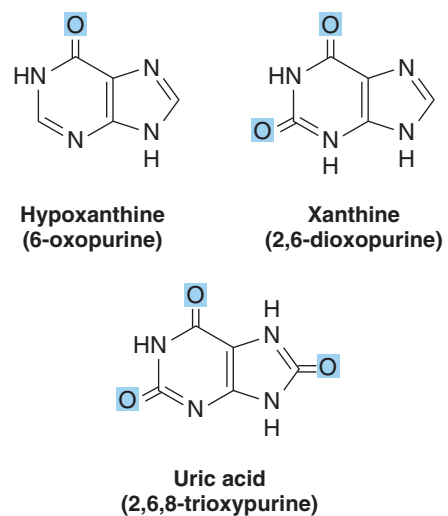

FIGURE 32-8 Structures of hypoxanthine, xanthine, and uric acid, drawn as the oxo tautomers.

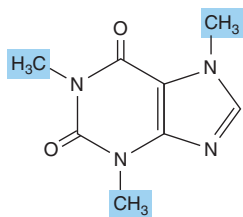

FIGURE 32-9 Caffeine, a trimethylxanthine. The dimethylxanthines theobromine and theophylline are similar but lack the methyl group at *N*-1 and at *N*-7, respectively.

of “absorbance at 260 nm.” The mutagenic effect of ultraviolet light is due to its absorption by nucleotides in DNA that results in chemical modifications (see Chapter 35).

Nucleotides Serve Diverse Physiologic Functions

In addition to their roles as precursors of nucleic acids, ATP, GTP, UTP, CTP, and their derivatives each serve unique physiologic functions discussed in other chapters. Selected examples include the role of ATP as the principal biologic transducer of free energy, and the second messenger cAMP (Figure 32-10). The mean intracellular concentration of ATP, the most abundant free nucleotide in mammalian cells, is about 1 mmol/L. Since little cAMP is required, the intracellular cAMP concentration (about 1 nmol/L) is six orders of magnitude below that of ATP. Other examples include adenosine 3'-phosphate-5'-phosphosulfate (Figure 32-11), the sulfate donor for sulfated proteoglycans (see Chapter 50) and for sulfate conjugates of drugs; and the methyl group donor *S*-adenosylmethionine (Figure 32-12). GTP serves as an allosteric regulator and as an energy source for protein synthesis, and cGMP (Figure 32-10) serves as a second messenger in response to nitric oxide (NO) during relaxation of smooth muscle (see Chapter 51).

UDP-sugar derivatives participate in sugar epimerizations and in biosynthesis of glycogen (see Chapter 18), glucosyl disaccharides, and the oligosaccharides of glycoproteins and proteoglycans (see Chapters 46 & 50). UDP-glucuronic

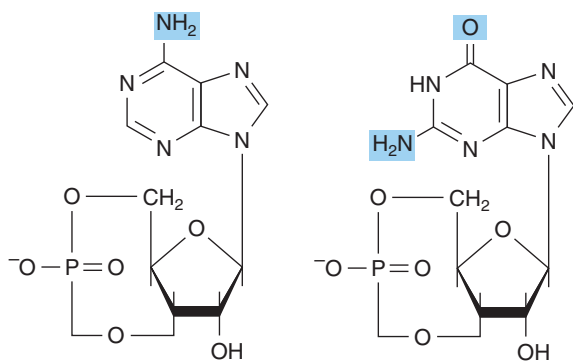

FIGURE 32-10 cAMP, 3',5'-cyclic AMP, and cGMP, 3',5'-cyclic GMP.

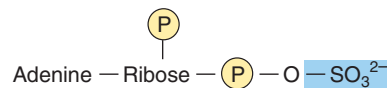

FIGURE 32-11 Adenosine 3'-phosphate-5'-phosphosulfate.

acid forms the urinary glucuronide conjugates of bilirubin (see Chapter 31) and of many drugs, including aspirin. CTP participates in biosynthesis of phosphoglycerides, sphingomyelin, and other substituted sphingosines (see Chapter 24). Finally, many coenzymes incorporate nucleotides as well as structures similar to purine and pyrimidine nucleotides (Table 32-2).

Nucleoside Triphosphates Have High Group Transfer Potential

Nucleotide triphosphates have two acid anhydride bonds and one ester bond. Unlike esters, acid anhydrides have a high-group transfer potential. ΔG° for the hydrolysis of each of the two terminal (β and γ) phosphoryl groups of a nucleoside triphosphate is about -7 kcal/mol (-30 kJ/mol). This high group transfer potential not only permits purine and pyrimidine nucleoside triphosphates to function as group transfer reagents, most commonly of the γ -phosphoryl group, but also on occasion transfer of a nucleotide monophosphate moiety with an accompanying release of PP_i . Cleavage of an acid anhydride bond typically is coupled with a highly endergonic process such as covalent bond synthesis, for example, the polymerization of nucleoside triphosphates to form a nucleic acid (see Chapter 34).

SYNTHETIC NUCLEOTIDE ANALOGS ARE USED IN CHEMOTHERAPY

Synthetic analogs of purines, pyrimidines, nucleosides, and nucleotides modified in the heterocyclic ring or in the sugar moiety have numerous applications in clinical medicine.

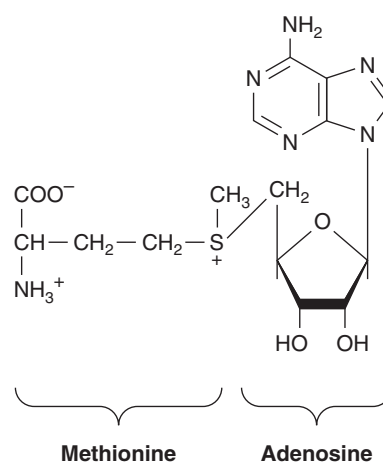
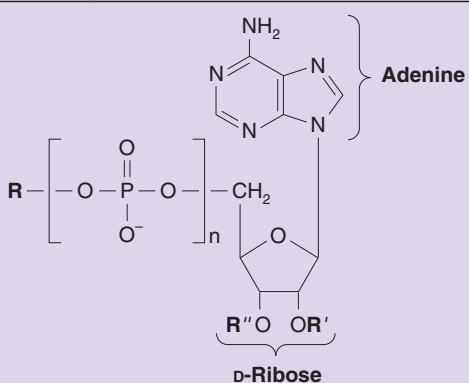

FIGURE 32-12 *S*-Adenosylmethionine.

TABLE 32-2 Many Coenzymes and Related Compounds Are Derivatives of Adenosine Monophosphate

Coenzyme	R	R'	R''	n
Active methionine	Methionine ^a	H	H	0
Amino acid adenylates	Amino acid	H	H	1
Active sulfate	SO ₃ ²⁻	H	PO ₃ ²⁻	1
3',5'-Cyclic AMP		H	PO ₃ ²⁻	1
NAD ^b	Nicotinamide	H	H	2
NADP ^b	Nicotinamide	PO ₃ ²⁻	H	2
FAD	Riboflavin	H	H	2
Coenzyme A	Pantothenate	H	PO ₃ ²⁻	2

^aReplaces phosphoryl group.^bR is a vitamin B derivative.

Their toxic effects reflect either inhibition of enzymes essential for nucleic acid synthesis or their incorporation into nucleic acids with resulting disruption of base pairing. Oncologists employ 5-fluoro- or 5-iodouracil, 3-deoxyuridine, 6-thioguanine and 6-mercaptopurine, 5- or 6-azauridine, 5- or 6-azacytidine, and 8-azaguanine (**Figure 32-13**), which are incorporated into DNA prior to cell division. The purine analog allopurinol, used in treatment of hyperuricemia and gout, inhibits purine biosynthesis and xanthine oxidase activity. Cytarabine is used in chemotherapy of cancer, and azathioprine, which is catabolized to 6-mercaptopurine, is employed during organ transplantation to suppress immunologic rejection (**Figure 32-14**).

Non-Hydrolyzable Nucleoside Triphosphate Analogs Serve as Research Tools

Synthetic, non-hydrolyzable analogs of nucleoside triphosphates (**Figure 32-15**) allow investigators to distinguish the effects of nucleotides due to phosphoryl transfer from effects mediated by occupancy of allosteric nucleotide-binding sites on regulated enzymes (see Chapter 9).

DNA & RNA ARE POLYNUCLEOTIDES

The 5'-phosphoryl group of a mononucleotide can esterify a second hydroxyl group, forming a **phosphodiester**. Most commonly, this second hydroxyl group is the 3'-OH of the pentose of a second nucleotide. This forms a **dinucleotide** in which the

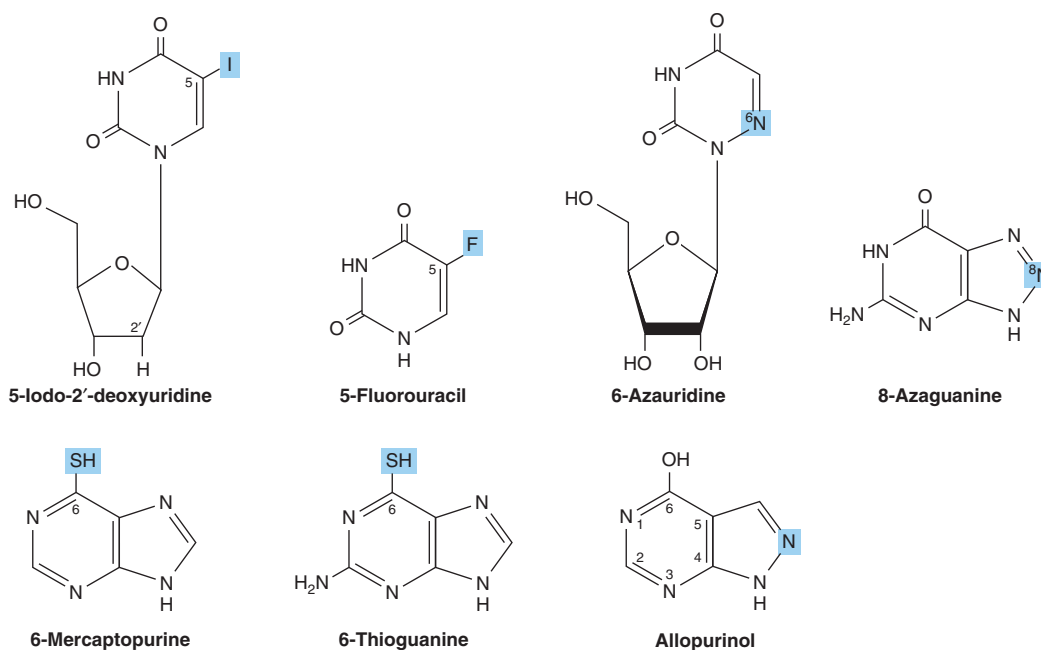
**FIGURE 32-13** Selected synthetic pyrimidine and purine analogs.

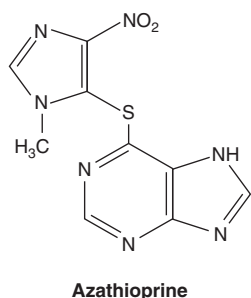
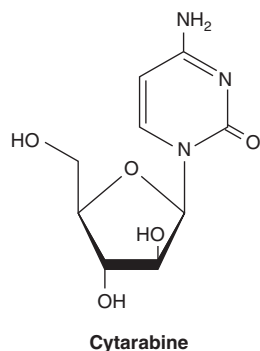

FIGURE 32-14 Arabinosylcytosine (cytarabine) and azathioprine.

pentose moieties are linked by a 3',5'-phosphodiester bond to form the “backbone” of RNA and DNA. The formation of a dinucleotide may be represented as the elimination of water between two mononucleotides. Biologic formation of dinucleotides does not, however, occur in this way because the reverse reaction, hydrolysis of the phosphodiester bond, is strongly favored on thermodynamic grounds. However, despite an extremely favorable ΔG , in the absence of catalysis by **phosphodiesterases** hydrolysis of the phosphodiester bonds of

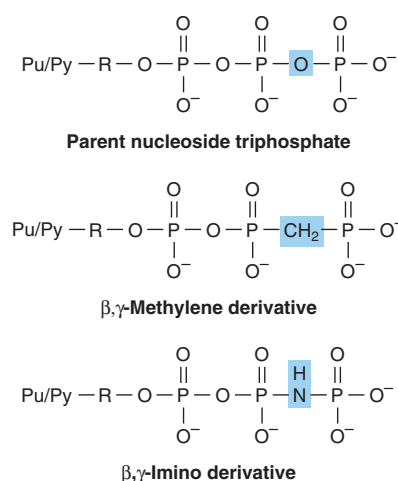

FIGURE 32-15 Synthetic derivatives of nucleoside triphosphates incapable of undergoing hydrolytic release of the terminal phosphoryl group. (Pu/Py, a purine or pyrimidine base; R, ribose or deoxyribose.) Shown are the parent (hydrolyzable) nucleoside triphosphate (**top**) and the unhydrolyzable β -methylene (**center**) and γ -imino derivatives (**bottom**).

DNA occurs only over long periods of time. DNA therefore persists for considerable periods, and has been detected even in fossils. RNAs are far less stable than DNA since the 2'-hydroxyl group of RNA (absent from DNA) functions as a nucleophile during hydrolysis of the 3',5'-phosphodiester bond.

Posttranslational modification of preformed **polynucleotides** can generate additional structures such as **pseudouridine**, a nucleoside in which D-ribose is linked to C-5 of uracil by a **carbon-to-carbon bond** rather than by the usual β -N-glycosidic bond. The nucleotide pseudouridylic acid (ψ) arises by rearrangement of a UMP of a preformed tRNA. Similarly, methylation by S-adenosylmethionine of a UMP of preformed tRNA forms TMP (thymidine monophosphate), which contains ribose rather than deoxyribose.

Polynucleotides Are Directional Macromolecules

Phosphodiester bonds link the 3'- and 5'-carbons of adjacent monomers. Each end of a nucleotide polymer thus is distinct. We therefore refer to the “5'-end” or the “3'-end” of a polynucleotide, the 5'-end being that with a free or phosphorylated 5'-hydroxyl group.

The base sequence or **primary structure** of a polynucleotide can be represented as shown below. The phosphodiester bond is represented by P or p, bases by a single letter, and pentoses by a vertical line.

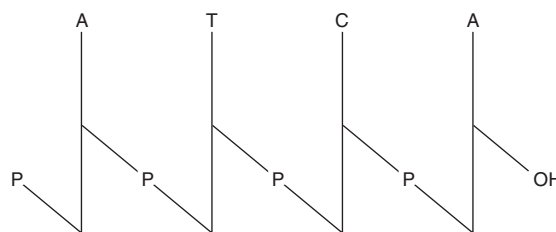

Where all the phosphodiester bonds are 3' \rightarrow 5', a more compact notation is possible:



This representation indicates that the 5'-hydroxyl—but not the 3'-hydroxyl—is phosphorylated. The most compact representation, for example GGATC, shows only the base sequence, written by convention with the 5'-end on the left and the 3'-end on the right. The phosphoryl groups are assumed to be present, but are not shown.

SUMMARY

- Under physiologic conditions, the amino and oxo tautomers of purines, pyrimidines, and their derivatives predominate.
- Nucleic acids contain, in addition to A, G, C, T, and U, traces of 5-methylcytosine, 5-hydroxymethylcytosine, pseudouridine (ψ), and N-methylated heterocycles.
- Most nucleosides contain D-ribose or 2-deoxy-D-ribose linked to N-1 of a pyrimidine or to N-9 of a purine by a β -glycosidic bond whose *syn* conformers predominate.

- A primed numeral indicates the hydroxyl to which the phosphoryl group of the sugars of mononucleotides (eg, 3'-GMP, 5'-dCMP) is attached. Additional phosphoryl groups linked to the first by acid anhydride bonds form nucleoside diphosphates and triphosphates.
- Nucleoside triphosphates have high group transfer potential and participate in covalent bond syntheses. The cyclic phosphodiester cAMP and cGMP function as intracellular second messengers.
- Mononucleotides linked by 3' → 5'-phosphodiester bonds form polynucleotides, directional macromolecules with distinct 3'- and 5'-ends. When represented as pTpGpT or TGCATCA, the 5'-end is at the left, and all phosphodiester bonds are 3' → 5'.

- Synthetic analogs of purine and pyrimidine bases and their derivatives serve as anticancer drugs either by inhibiting an enzyme of nucleotide biosynthesis or by being incorporated into DNA or RNA.

REFERENCES

- Adams RLP, Knowler JT, Leader DP: *The Biochemistry of the Nucleic Acids*, 11th ed. Chapman & Hall, 1992.
- Blackburn GM, Gait MJ: *Nucleic Acids in Chemistry & Biology*. IRL Press, 1990.
- Pacher P, Nivorozhkin A, Szabo C: Therapeutic effects of xanthine oxidase inhibitors: renaissance half a century after the discovery of allopurinol. *Pharmacol Rev* 2006;58:87.

Metabolism of Purine & Pyrimidine Nucleotides

Victor W. Rodwell, PhD

OBJECTIVES

After studying this chapter, you should be able to:

- Compare and contrast the roles of dietary nucleic acids and of de novo biosynthesis in the production of purines and pyrimidines destined for polynucleotide biosynthesis.
- Explain why antifolate drugs and analogs of the amino acid glutamine inhibit purine biosynthesis.
- Outline the sequence of reactions that convert IMP, first to AMP and GMP, and subsequently to their corresponding nucleoside triphosphates.
- Describe the formation from ribonucleotides of deoxyribonucleotides (dNTPs).
- Indicate the regulatory role of PRPP in hepatic purine biosynthesis and the specific reaction of hepatic purine biosynthesis that is feedback inhibited by AMP and by GMP.
- State the relevance of coordinated control of purine and pyrimidine nucleotide biosynthesis.
- Identify the reactions discussed that are inhibited by anticancer drugs.
- Write the structure of the end product of purine catabolism. Comment on its solubility and indicate its role in gout, Lesch-Nyhan syndrome, and von Gierke disease.
- Identify reactions whose impairment leads to modified pathologic signs and symptoms.
- Indicate why there are few clinically significant disorders of pyrimidine catabolism.

BIOMEDICAL IMPORTANCE

Despite a diet that may be rich in nucleoproteins, dietary purines and pyrimidines are not incorporated directly into tissue nucleic acids. Humans synthesize the nucleic acids and their derivatives ATP, NAD⁺, coenzyme A, etc, from amphibolic intermediates. However, *injected* purine or pyrimidine analogs, including potential anticancer drugs, may nevertheless be incorporated into DNA. The biosyntheses of purine and pyrimidine ribonucleotide triphosphates (NTPs) and dNTPs are precisely regulated events. Coordinated feedback mechanisms ensure their production in appropriate quantities and at times that match varying physiologic demand (eg, cell division). Human diseases that involve abnormalities in purine metabolism include gout, Lesch-Nyhan syndrome, adenosine deaminase deficiency, and

purine nucleoside phosphorylase deficiency. Diseases of pyrimidine biosynthesis are rarer, but include orotic acidurias. Unlike the low solubility of uric acid formed by catabolism of purines, the end products of pyrimidine catabolism (carbon dioxide, ammonia, β -alanine, and γ -aminoisobutyrate) are highly water soluble. One genetic disorder of pyrimidine catabolism, β -hydroxybutyric aciduria, is due to total or partial deficiency of the enzyme dihydropyrimidine dehydrogenase. This disorder of pyrimidine catabolism, also known as combined uraciluria-thyminuria, is also a disorder of β -amino acid biosynthesis, since the formation of β -alanine and of β -aminoisobutyrate is impaired. A nongenetic form can be triggered by administration of 5-fluorouracil to patients with low levels of dihydropyrimidine dehydrogenase.

PURINES & PYRIMIDINES ARE DIETARILY NONESSENTIAL

Normal human tissues can synthesize purines and pyrimidines from amphibolic intermediates in quantities and at times appropriate to meet variable physiologic demand. Ingested nucleic acids and nucleotides therefore are dietarily nonessential. Following their degradation in the intestinal tract, the resulting mononucleotides may be absorbed or converted to purine and pyrimidine bases. The purine bases are then oxidized to uric acid, which may be absorbed and excreted in the urine. While little or no dietary purine or pyrimidine is incorporated into tissue nucleic acids, *injected* compounds are incorporated. The incorporation of injected [³H]thymidine into newly synthesized DNA thus can be used to measure the rate of DNA synthesis.

BIOSYNTHESIS OF PURINE NUCLEOTIDES

With the exception of parasitic protozoa, all forms of life synthesize purine and pyrimidine nucleotides. Synthesis from amphibolic intermediates proceeds at controlled rates appropriate for all cellular functions. To achieve homeostasis, intracellular mechanisms sense and regulate the pool sizes of NTPs, which rise during growth or tissue regeneration when cells are rapidly dividing.

Purine and pyrimidine nucleotides are synthesized *in vivo* at rates consistent with physiologic need. Early investigations of nucleotide biosynthesis first employed birds, and later *Escherichia coli*. Isotopic precursors of uric acid fed to pigeons established the source of each atom of a purine (Figure 33–1) and initiated study of the intermediates of purine biosynthesis. Avian tissues also served as a source of cloned genes that encode enzymes of purine biosynthesis and the regulatory proteins that control the rate of purine biosynthesis.

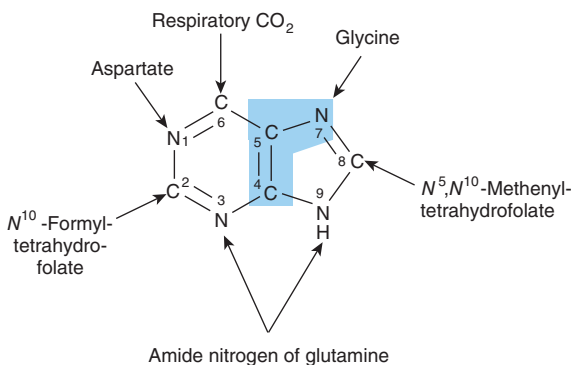

FIGURE 33–1 Sources of the nitrogen and carbon atoms of the purine ring. Atoms 4, 5, and 7 (blue highlight) derive from glycine.

The three processes that contribute to purine nucleotide biosynthesis are, in order of decreasing importance.

1. Synthesis from amphibolic intermediates (synthesis *de novo*).
2. Phosphoribosylation of purines.
3. Phosphorylation of purine nucleosides.

INOSINE MONOPHOSPHATE (IMP) IS SYNTHESIZED FROM AMPHIBOLIC INTERMEDIATES

Figure 33–2 depicts the intermediates and the 11 enzyme-catalyzed reactions that convert α -D-ribose 5-phosphate to inosine monophosphate (IMP). The first intermediate formed in the *de novo* pathway for purine biosynthesis is 5-phosphoribosyl 1-pyrophosphate (PRPP; structure II, Figure 33–2). PRPP is also an intermediate in the biosynthesis of pyrimidine nucleotides, NAD⁺, and NADP⁺. Stepwise assembly of the 9-membered purine ring then takes place on PRPP as a scaffold.

Following synthesis of IMP, separate branches lead to AMP and GMP (Figure 33–3). Subsequent phosphoryl transfer from ATP converts AMP and GMP to ADP and GDP, respectively. Conversion of GDP to GTP involves a second phosphoryl transfer from ATP, whereas conversion of ADP to ATP is achieved primarily by oxidative phosphorylation (see Chapter 13).

Multifunctional Catalysts Participate in Purine Nucleotide Biosynthesis

In prokaryotes, each reaction of Figure 33–2 is catalyzed by a different polypeptide. By contrast, the enzymes of eukaryotes are polypeptides that possess multiple catalytic activities whose adjacent catalytic sites facilitate channeling of intermediates between sites. Three distinct multifunctional enzymes catalyze reactions ③, ④, and ⑥; reactions ⑦ and ⑧; and reactions ⑩ and ⑪ of Figure 33–2.

Antifolate Drugs & Glutamine Analogs Block Purine Nucleotide Biosynthesis

The carbons added in reactions ④ and ⑩ of Figure 33–2 are contributed by derivatives of tetrahydrofolate. Purine deficiency states, while rare in humans, generally reflect a deficiency of folic acid. Compounds that inhibit formation of tetrahydrofolates and therefore block purine synthesis have been used in cancer chemotherapy. Inhibitory compounds and the reactions they inhibit include **azaserine** (reaction ⑤, Figure 33–2), **diazanorleucine** (reaction ②, Figure 33–2), **6-mercaptopurine** (reactions ⑬ and ⑭, Figure 33–3), and **mycophenolic acid** (reaction ⑭, Figure 33–3).

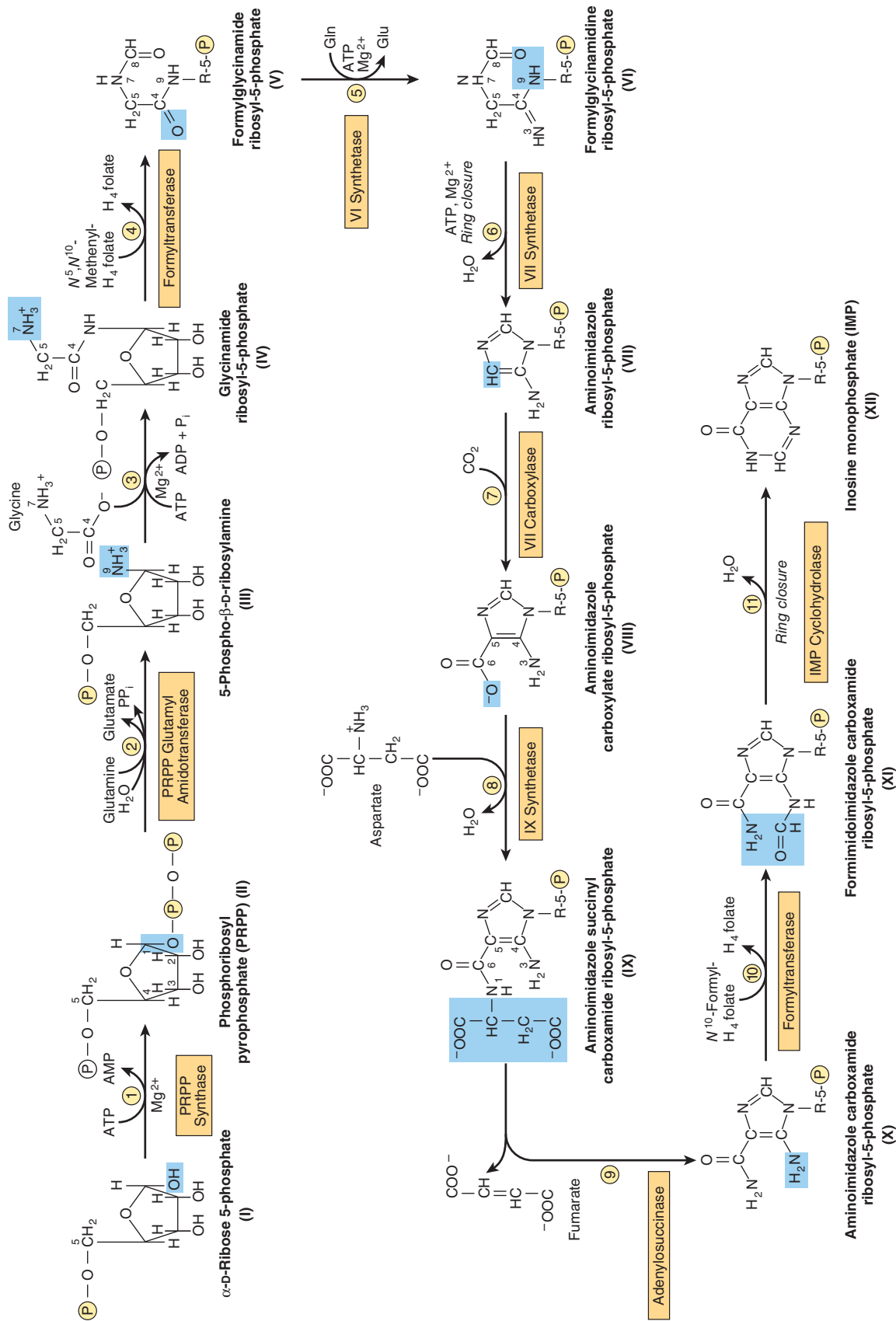

FIGURE 33-2 Purine biosynthesis from ribose 5-phosphate and ATP. See the text for explanations. (P), PO_3^- or PO_2^- .

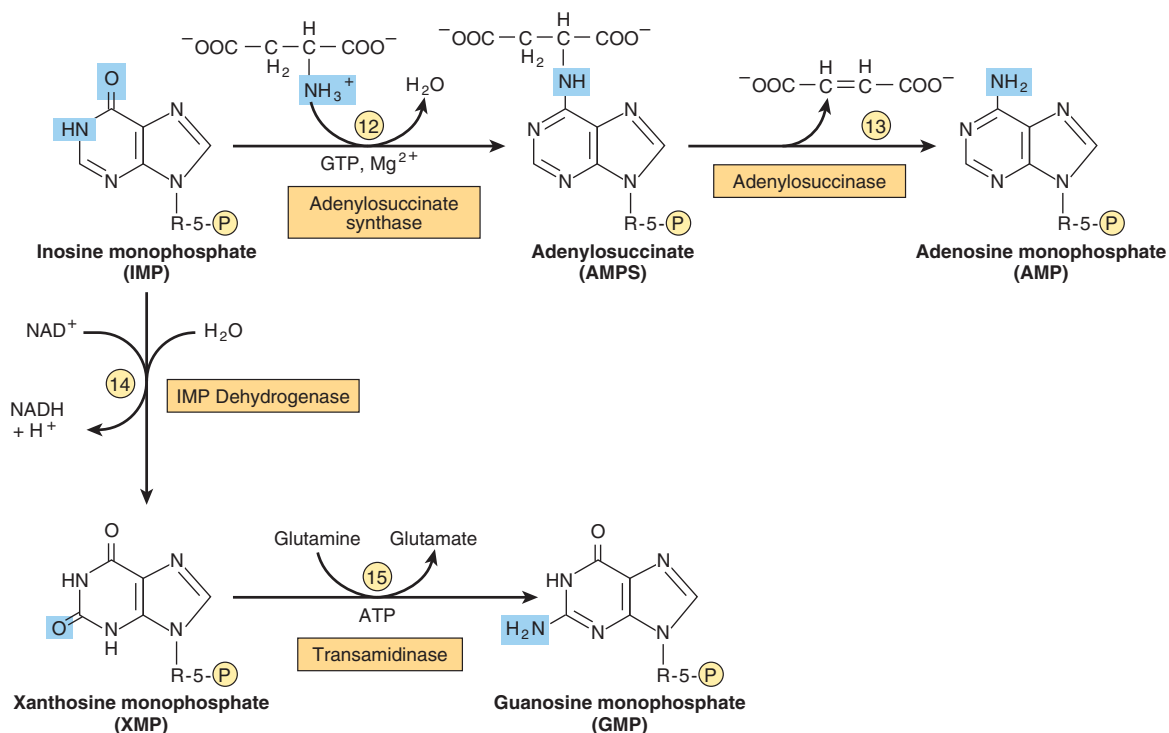
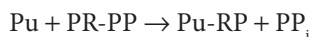

FIGURE 33-3 Conversion of IMP to AMP and GMP.

“SALVAGE REACTIONS” CONVERT PURINES & THEIR NUCLEOSIDES TO MONONUCLEOTIDES

Conversion of purines, their ribonucleosides, and their deoxyribonucleosides to mononucleotides involves “salvage reactions” that require far less energy than de novo synthesis. The more important mechanism involves phosphorylation by PRPP (structure II, Figure 33-2) of a free purine (Pu) to form a purine 5'-mononucleotide (Pu-RP).



Phosphoryl transfer from PRPP catalyzed by adenosine- and hypoxanthine-phosphoribosyl transferases (EC 2.4.2.7 & EC 2.4.2.8, respectively), converts adenine, hypoxanthine, and guanine to their mononucleotides (Figure 33-4).

A second salvage mechanism involves phosphoryl transfer from ATP to a purine ribonucleoside (Pu-R):

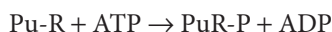

Phosphorylation of the purine nucleotides, catalyzed by adenosine kinase (EC 2.7.1.20), converts adenosine and deoxyadenosine to AMP and dAMP. Similarly, deoxycytidine kinase (EC 2.7.1.24) phosphorylates deoxycytidine and 2'-deoxyguanosine, forming dCMP and dGMP, respectively.

Liver, the major site of purine nucleotide biosynthesis, provides purines and purine nucleosides for salvage and for

utilization by tissues incapable of their biosynthesis. Human brain tissue has a low level of PRPP glutamyl amidotransferase, EC 2.4.2.14 (reaction ②, Figure 33-2) and hence depends in part on exogenous purines. Erythrocytes and polymorphonuclear leukocytes cannot synthesize 5-phosphoribosylamine (structure III, Figure 33-2) and, therefore, also utilize exogenous purines to form nucleotides.

HEPATIC PURINE BIOSYNTHESIS IS STRINGENTLY REGULATED

AMP & GMP Feedback Regulate PRPP Glutamyl Amidotransferase

Biosynthesis of IMP is energetically expensive. In addition to ATP, glycine, glutamine, aspartate, and reduced tetrahydrofolate derivatives all are consumed. It thus is of survival advantage to closely regulate purine biosynthesis in response to varying physiologic need. The overall determinant of the rate of de novo purine nucleotide biosynthesis is the concentration of PRPP. This, in turn, depends on the rate of PRPP synthesis, utilization, degradation, and regulation. The rate of PRPP synthesis depends on the availability of ribose 5-phosphate and on the activity of PRPP synthase, EC 2.7.6.1 (reaction ② Figure 33-5), an enzyme whose activity is feedback inhibited by AMP, ADP, GMP, and GDP. Elevated levels of these nucleoside phosphates thus signal a physiologically appropriate overall decrease in their biosynthesis.

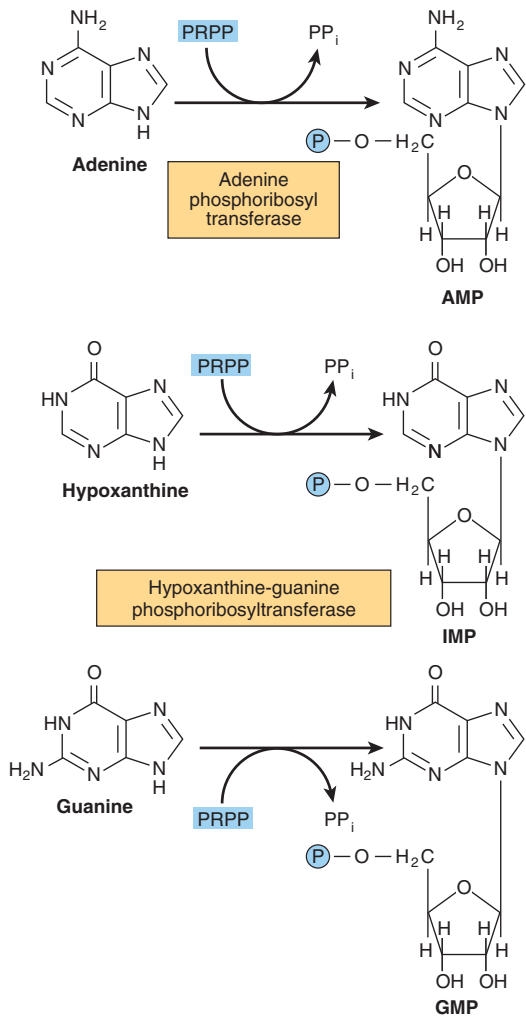

FIGURE 33-4 Phosphoribosylation of adenine, hypoxanthine, and guanine to form AMP, IMP, and GMP, respectively.

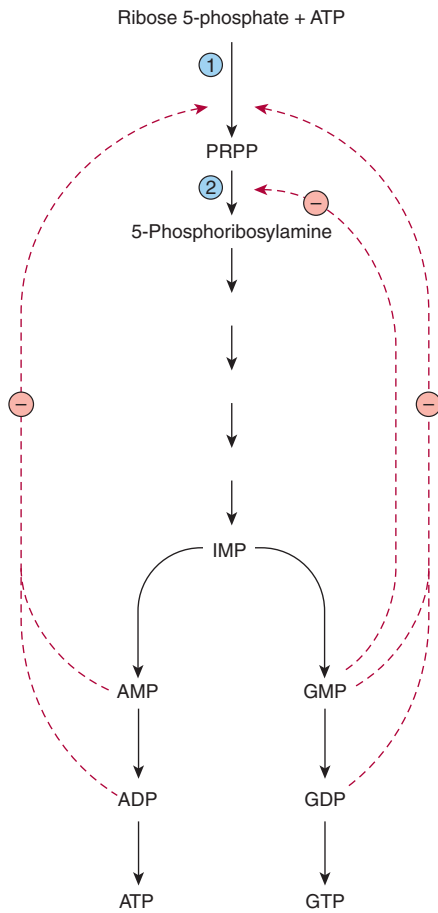

FIGURE 33-5 Control of the rate of de novo purine nucleotide biosynthesis. Reactions ① and ② are catalyzed by PRPP synthase and by PRPP glutamyl amidotransferase, respectively. Solid lines represent chemical flow. Broken red lines represent feedback inhibition by intermediates of the pathway.

AMP & GMP Feedback Regulate Their Formation From IMP

In addition to regulation at the level of PRPP biosynthesis, additional mechanisms that regulate conversion of IMP to ATP and GTP are summarized in **Figure 33-6**. AMP feedback inhibits adenylosuccinate synthase, EC 6.3.4.4 (reaction ⑫, Figure 33-3), and GMP inhibits IMP dehydrogenase, EC 1.1.1.205 (reaction ⑭, Figure 33-3). Furthermore, conversion of IMP to adenylosuccinate en route to AMP (reaction ⑫, Figure 33-3) requires GTP, and conversion of xanthinylate (XMP) to GMP requires ATP. This cross-regulation between the pathways of IMP metabolism thus serves to balance the biosynthesis of purine nucleoside triphosphates by decreasing the synthesis of one purine nucleotide when there is a deficiency of the other nucleotide. AMP and GMP also inhibit hypoxanthine-guanine phosphoribosyltransferase, which converts hypoxanthine and guanine to IMP and GMP (Figure 33-4), and GMP feedback inhibits PRPP glutamyl amidotransferase (reaction ②, Figure 33-2).

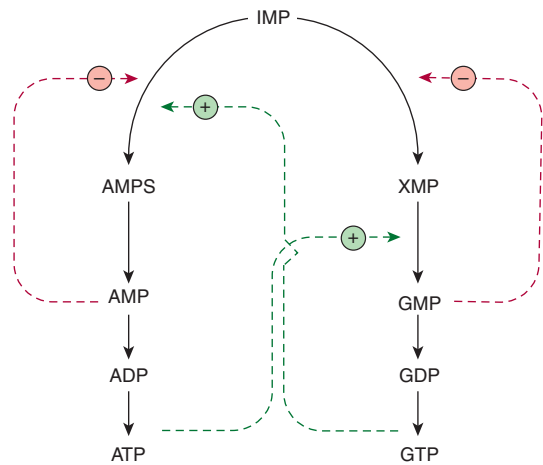

FIGURE 33-6 Regulation of the conversion of IMP to adenosine nucleotides and guanosine nucleotides. Solid lines represent chemical flow. Broken green lines represent positive feedback loops ⊕, and broken red lines represent negative feedback loops ⊖. Abbreviations include AMPS (adenylosuccinate) and XMP (xanthosine monophosphate), whose structures are given in Figure 33-3.

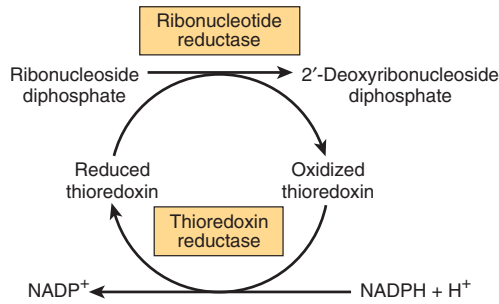

FIGURE 33-7 Reduction of ribonucleoside diphosphates to 2'-deoxyribonucleoside diphosphates.

REDUCTION OF RIBONUCLEOSIDE DIPHOSPHATES FORMS DEOXYRIBONUCLEOSIDE DIPHOSPHATES

Reduction of the 2'-hydroxyl of purine and pyrimidine ribonucleotides, catalyzed by the complex that includes **ribonucleotide reductase**, EC 1.17.4.1 (Figure 33-7), provides the deoxyribonucleoside diphosphates (dNDPs) needed for both the synthesis and repair of DNA (see Chapter 35). The enzyme complex is functional only when cells are actively synthesizing DNA. Reduction requires reduced thioredoxin, thioredoxin reductase (EC 1.8.1.9), and NADPH. The immediate reductant, reduced thioredoxin, is produced by NADPH-dependent reduction of oxidized thioredoxin (Figure 33-7). The reduction of ribonucleoside diphosphates (NDPs) to dNDPs is subject to complex regulatory controls that achieve balanced production of dNTPs for synthesis of DNA (Figure 33-8).

BIOSYNTHESIS OF PYRIMIDINE NUCLEOTIDES

Figure 33-9 illustrates the intermediates and enzymes of pyrimidine nucleotide biosynthesis. The catalyst for the initial reaction is *cytosolic* carbamoyl phosphate synthase II (EC 6.3.5.5), a different enzyme from the *mitochondrial* carbamoyl phosphate synthase I of urea synthesis (see Figure 28-16). Compartmentation thus provides an independent pool of carbamoyl phosphate for each process. Unlike in purine biosynthesis where PRPP serves as a scaffold for assembly of the purine ring (Figure 33-2), PRPP participates in pyrimidine biosynthesis only subsequent to assembly of the pyrimidine ring. Inspection of the reaction components in Figure 33-9 will reveal that, like the biosynthesis of pyrimidines, the biosynthesis of the purine nucleosides is energetically costly.

Multifunctional Proteins Catalyze the Early Reactions of Pyrimidine Biosynthesis

Five of the first six enzyme activities of pyrimidine biosynthesis reside on **multifunctional polypeptides**. One polypeptide

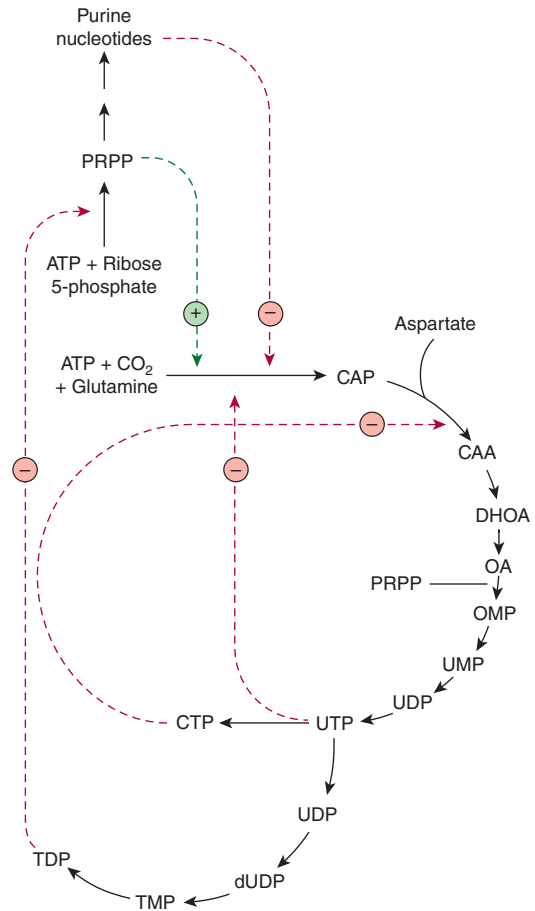

FIGURE 33-8 Regulatory aspects of the biosynthesis of purine and pyrimidine ribonucleotides and reduction to their respective 2'-deoxyribonucleotides. The broken green line represents a positive feedback loop. Broken red lines represent negative feedback loops. Abbreviations for the intermediates in the biosynthesis of pyrimidine nucleotides whose structures are given in Figure 33-9 are: (CAA, carbamoyl aspartate; DHOA, dihydroorotate; OA, orotic acid; OMP, orotidine monophosphate; and PRPP phosphoribosyl pyrophosphate).

catalyzes the first three reactions of Figure 33-9. A second bifunctional enzyme catalyzes reactions ⑤ and ⑥ of Figure 33-9. The close proximity of multiple active sites on a multifunctional polypeptide facilitates efficient channeling of the intermediates of pyrimidine biosynthesis.

THE DEOXYRIBONUCLEOSIDES OF URACIL & CYTOSINE ARE SALVAGED

Adenine, guanine, and hypoxanthine released during the turnover of nucleic acids, notably messenger RNAs, are reconverted to nucleoside triphosphates via so-called **salvage pathways**. While mammalian cells reutilize few *free* pyrimidines, “salvage reactions” convert the pyrimidine ribonucleosides uridine and

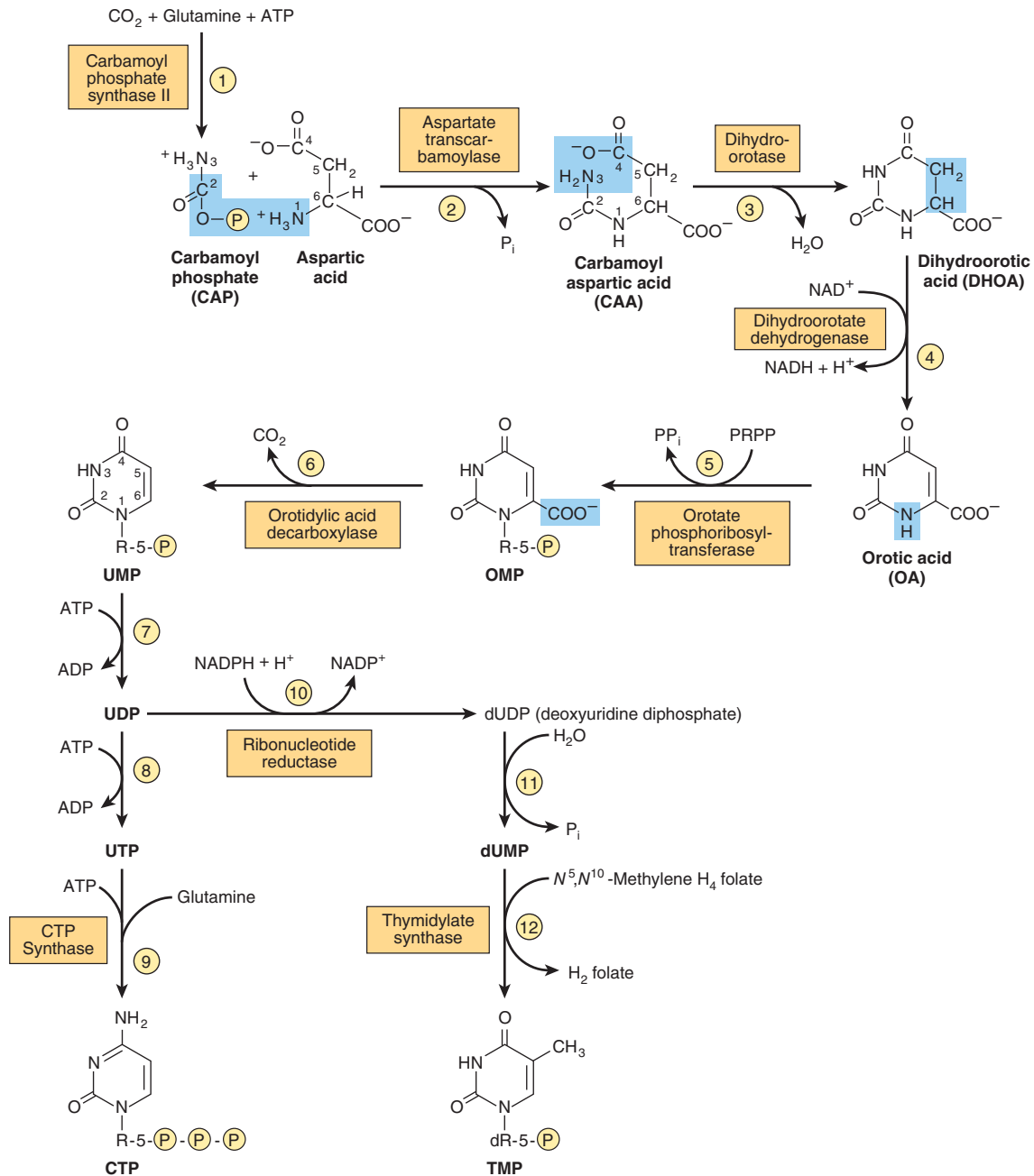
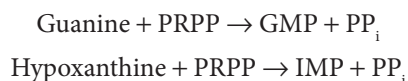
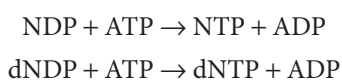

FIGURE 33–9 The biosynthetic pathway for pyrimidine nucleotides.

cytidine and the pyrimidine deoxyribonucleosides thymidine and deoxycytidine to their respective nucleotides.



Phosphoryltransferases (kinases) catalyze transfer of the γ -phosphoryl group of ATP to the diphosphates of the dNDPs 2'-deoxycytidine, 2'-deoxyguanosine, and 2'-deoxyadenosine, converting them to the corresponding nucleoside triphosphates.



Methotrexate Blocks Reduction of Dihydrofolate

The reaction catalyzed by thymidylate synthase, EC 2.1.1.45 (reaction 12 of Figure 33–9) is the only reaction of pyrimidine nucleotide biosynthesis that requires a tetrahydrofolate derivative. During this reaction the methylene group of N^5,N^{10} -methylene-tetrahydrofolate is reduced to the methyl group that is transferred to the 5-position of the pyrimidine ring, and tetrahydrofolate is oxidized to dihydrofolate. For further pyrimidine synthesis to occur, dihydrofolate must be reduced back to tetrahydrofolate. This reduction, catalyzed by dihydrofolate reductase (EC 1.5.1.3), is inhibited by **methotrexate**.

Dividing cells, which must generate TMP and dihydrofolate, thus are especially sensitive to inhibitors of dihydrofolate reductase such as the anticancer drug methotrexate.

Certain Pyrimidine Analogs Are Substrates for Enzymes of Pyrimidine Nucleotide Biosynthesis

Allopurinol and the anticancer drug **5-fluorouracil** (see Figure 32–13) are alternate substrates for orotate phosphoribosyltransferase, EC 2.4.2.10 (reaction ⑤, Figure 33–9). Both drugs are phosphoribosylated, and allopurinol is converted to a nucleotide in which the ribosyl phosphate is attached to N^1 of the pyrimidine ring.

REGULATION OF PYRIMIDINE NUCLEOTIDE BIOSYNTHESIS

Gene Expression & Enzyme Activity Both Are Regulated

The activities of the first and second enzymes of pyrimidine nucleotide biosynthesis are controlled by allosteric regulation. Carbamoyl phosphate synthase II (reaction ①, Figure 33–9) is inhibited by UTP and purine nucleotides but activated by PRPP. Aspartate transcarbamoylase, EC 2.1.3.2 (reaction ②, Figure 33–9) is inhibited by CTP but is activated by ATP (Figure 33–10). In addition, the first three and the last two enzymes of the pathway are regulated by coordinate repression and derepression.

Purine & Pyrimidine Nucleotide Biosynthesis Are Coordinately Regulated

Purine and pyrimidine biosynthesis parallel one another quantitatively, that is, mole for mole, suggesting coordinated

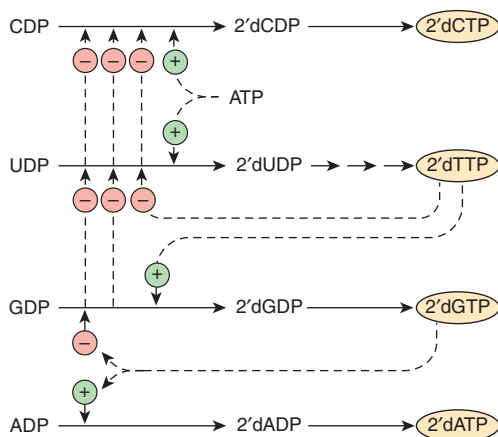

FIGURE 33–10 Control of pyrimidine nucleotide biosynthesis. Solid lines represent chemical flow. Broken green lines represent positive \oplus , and broken red lines negative \ominus feedback regulation.

control of their biosynthesis. Several sites of *cross-regulation* characterize the pathways that lead to the biosynthesis of purine and pyrimidine nucleotides. PRPP synthase (reaction ①, Figure 33–2), which forms a precursor essential for both processes, is feedback inhibited by both purine and pyrimidine nucleotides.

HUMANS CATABOLIZE PURINES TO URIC ACID

Humans convert adenosine and guanosine to uric acid (Figure 33–11). Adenosine is first converted to inosine by adenosine deaminase, EC 3.5.4.4. In mammals other than higher primates, uricase, (EC 1.7.3.3) converts uric acid to the water-soluble product allantoin. However, since humans lack uricase, the end product of purine catabolism in humans is uric acid.

GOUT IS A METABOLIC DISORDER OF PURINE CATABOLISM

Various genetic defects in PRPP synthase (reaction ①, Figure 33–2) present clinically as gout. Each defect—for example, an elevated V_{max} , increased affinity for ribose 5-phosphate, or resistance to feedback inhibition—results in overproduction and overexcretion of purine catabolites. When serum urate levels exceed the solubility limit, sodium urate crystallizes in soft tissues and joints and causes an inflammatory reaction, **gouty arthritis**. However, most cases of gout reflect abnormalities in renal handling of uric acid.

OTHER DISORDERS OF PURINE CATABOLISM

While purine deficiency states are rare in human subjects, there are numerous genetic disorders of purine catabolism. **Hyperuricemias** may be differentiated based on whether patients excrete normal or excessive quantities of total urates. Some hyperuricemias reflect specific enzyme defects. Others are secondary to diseases such as cancer or psoriasis that enhance tissue turnover.

Lesch-Nyhan Syndrome

The Lesch-Nyhan syndrome, an overproduction hyperuricemia characterized by frequent episodes of uric acid lithiasis and a bizarre syndrome of self-mutilation, reflects a defect in **hypoxanthine-guanine phosphoribosyl transferase**, an enzyme of purine salvage (Figure 33–4). The accompanying rise in intracellular PRPP results in purine overproduction. Mutations that decrease or abolish hypoxanthine-guanine

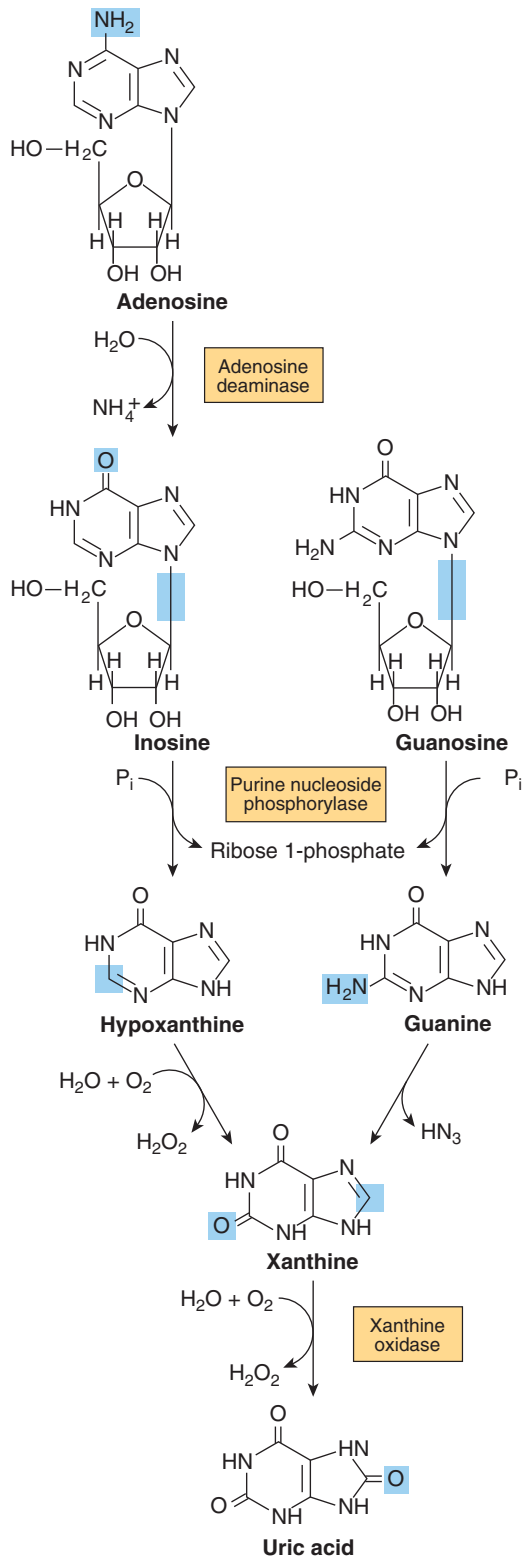

FIGURE 33-11 Formation of uric acid from purine nucleosides by way of the purine bases hypoxanthine, xanthine, and guanine. Purine deoxyribonucleosides are degraded by the same catabolic pathway and enzymes, all of which exist in the mucosa of the mammalian gastrointestinal tract.

phosphoribosyltransferase activity include deletions, frame-shift mutations, base substitutions, and aberrant mRNA splicing.

von Gierke Disease

Purine overproduction and hyperuricemia in von Gierke disease (**glucose-6-phosphatase deficiency**) occurs secondary to enhanced generation of the PRPP precursor ribose 5-phosphate. An associated lactic acidosis elevates the renal threshold for urate, elevating total body urates.

Hypouricemia

Hypouricemia and increased excretion of hypoxanthine and xanthine are associated with a deficiency in **xanthine oxidase**, EC 1.17.3.2 (Figure 33-11) due to a genetic defect or to severe liver damage. Patients with a severe enzyme deficiency may exhibit xanthinuria and xanthine lithiasis.

Adenosine Deaminase & Purine Nucleoside Phosphorylase Deficiency

Adenosine deaminase deficiency (Figure 33-11) is associated with an immunodeficiency disease in which both thymus-derived lymphocytes (T cells) and bone marrow-derived lymphocytes (B cells) are sparse and dysfunctional. Patients suffer from severe immunodeficiency. In the absence of enzyme replacement or bone marrow transplantation, infants often succumb to fatal infections. Defective activity of **purine nucleoside phosphorylase** (EC 2.4.2.1) is associated with a severe deficiency of T cells, but apparently normal B-cell function. Immune dysfunctions appear to result from accumulation of dGTP and dATP, which inhibit ribonucleotide reductase and thereby deplete cells of DNA precursors. **Table 33-1** summarizes known disorders of purine metabolism.

CATABOLISM OF PYRIMIDINES PRODUCES WATER-SOLUBLE METABOLITES

Unlike the low solubility products of purine catabolism, catabolism of the pyrimidines forms highly water-soluble products— CO_2 , NH_3 , β -alanine, and β -aminoisobutyrate (**Figure 33-12**). Humans transaminate β -aminoisobutyrate to methylmalonate semialdehyde, which then forms succinyl-CoA (see Figure 19-2). Excretion of β -aminoisobutyrate increases in leukemia and severe x-ray radiation exposure due to increased destruction of DNA. However, many persons of Chinese or Japanese ancestry routinely excrete β -aminoisobutyrate.

Disorders of β -alanine and β -aminoisobutyrate metabolism arise from defects in enzymes of pyrimidine catabolism. These include **β -hydroxybutyric aciduria**, a disorder due to total or partial deficiency of the enzyme **dihydropyrimidine**

TABLE 33–1 Metabolic Disorders of Purine and Pyrimidine Metabolism

Defective Enzyme	Enzyme Catalog Number	OMIM Reference	Major Signs and Symptoms	Figure and Reaction
Purine Metabolism				
Hypoxanthine-guanine phosphoribosyl transferase	2.4.2.8	308000	Lesch-Nyhan syndrome. Uricemia, self-mutilation	33–4 ②
PRPP synthase	2.7.6.1	311860	Gout; gouty arthritis	33–2 ①
Adenosine deaminase	3.5.4.6	102700	Severely compromised immune system	33–1 ①
Purine nucleoside phosphorylase	2.4.2.1	164050	Autoimmune disorders; benign and opportunistic infections	33–11 ②
Pyrimidine Metabolism				
Dihydropyrimidine dehydrogenase	1.3.1.2	274270	Can develop toxicity to 5-fluorouracil, also a substrate for this dehydrogenase	33–12 ②
Orotate phosphoribosyl transferase and orotidylic acid decarboxylase	2.4.2.10 and 4.1.1.23	258900	Orotic acid aciduria type 1; megaloblastic anemia	33–9 ⑤ and ⑥
Orotidylic acid decarboxylase	4.1.1.23	258920	Orotic acid aciduria type 2	33–9 ⑥

dehydrogenase, EC 1.3.1.2 (Figure 33–12). The genetic disease reflects an absence of the enzyme. A disorder of pyrimidine catabolism, known also as combined uraciluria-thyminuria, is also a disorder of β -amino acid metabolism, since the *formation* of β -alanine and of β -aminoisobutyrate is impaired. When due to an inborn error, there are serious neurological complications. A nongenetic form is triggered by the administration of the anticancer drug 5-fluorouracil (see Figure 32–13) to patients with low levels of dihydropyrimidine dehydrogenase.

Pseudouridine Is Excreted Unchanged

No human enzyme catalyzes hydrolysis or phosphorolysis of the pseudouridine (ψ) derived from the degradation of RNA molecules. This unusual nucleotide therefore is excreted unchanged in the urine of normal subjects. Pseudouridine was indeed first isolated from human urine (Figure 33–13).

OVERPRODUCTION OF PYRIMIDINE CATABOLITES IS ONLY RARELY ASSOCIATED WITH CLINICALLY SIGNIFICANT ABNORMALITIES

Since the end products of pyrimidine catabolism are highly water-soluble, pyrimidine overproduction results in few clinical signs or symptoms. Table 33–1 lists exceptions. In

hyperuricemia associated with severe overproduction of PRPP, there is overproduction of pyrimidine nucleotides and increased excretion of β -alanine. Since N^5, N^{10} -methylene-tetrahydrofolate is required for thymidylate synthesis, disorders of folate and vitamin B₁₂ metabolism result in deficiencies of TMP.

Orotic Aciduria

The orotic aciduria that accompanies the **Reye syndrome** probably is a consequence of the inability of severely damaged mitochondria to utilize carbamoyl phosphate, which then becomes available for cytosolic overproduction of orotic acid. **Type-I orotic aciduria** reflects a deficiency of both orotate phosphoribosyltransferase (EC 2.1.3.3) and orotidylate decarboxylase, EC 4.1.1.23 (reactions ⑤ and ⑥, Figure 33–9). The rarer **Type-II orotic aciduria** is due to a deficiency only of orotidylate decarboxylase (reaction ⑥, Figure 33–9).

Deficiency of a Urea Cycle Enzyme Results in Excretion of Pyrimidine Precursors

Increased excretion of orotic acid, uracil, and uridine accompanies a deficiency in liver mitochondrial ornithine transcarbamoylase (see reaction ②, Figure 28–16). Excess carbamoyl phosphate exits to the cytosol, where it stimulates pyrimidine nucleotide biosynthesis. The resulting mild **orotic aciduria** is increased by high-nitrogen foods.

Drugs May Precipitate Orotic Aciduria

Allopurinol (see Figure 32–13), an alternative substrate for orotate phosphoribosyltransferase (reaction ⑤, Figure 33–9),

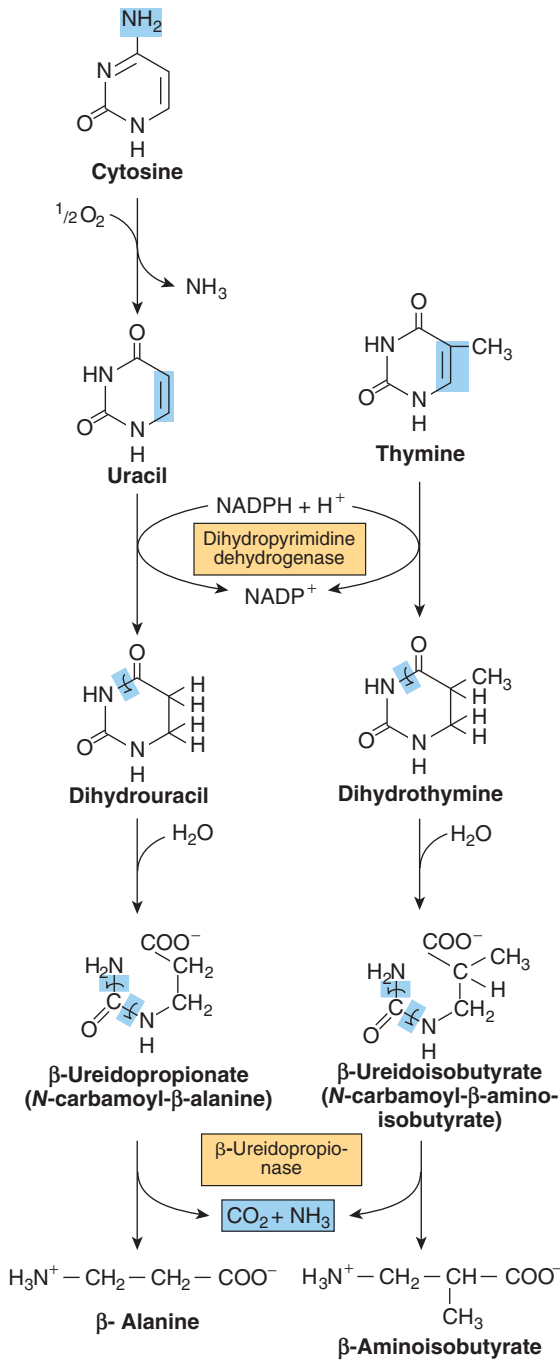

FIGURE 33-12 Catabolism of pyrimidines. Hepatic β -ureidopropionase catalyzes the formation of both β -alanine and β -aminoisobutyrate from their pyrimidine precursors.

competes with orotic acid. The resulting nucleotide product also inhibits orotidylate decarboxylase (reaction (6), Figure 33-9), resulting in **orotic aciduria** and **orotidinuria**. 6-Azauridine, following conversion to 6-azauridylylate, also competitively inhibits orotidylate decarboxylase (reaction (6), Figure 33-9), enhancing excretion of orotic acid and orotidine. Four genes that encode urate transporters have been identified. Two of the encoded proteins are localized to the apical membrane of proximal tubular cells.

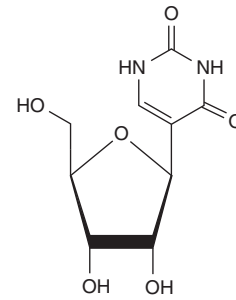

FIGURE 33-13 Pseudouridine, in which ribose is linked to C5 of uridine.

SUMMARY

- Ingested nucleic acids are degraded to purines and pyrimidines. Purines and pyrimidines are formed from amphibolic intermediates and thus are dietarily nonessential.
- Several reactions of IMP biosynthesis require folate derivatives and glutamine. Consequently, antifolate drugs and glutamine analogs inhibit purine biosynthesis.
- IMP is a precursor both of AMP and of GMP. Glutamine provides the 2-amino group of GMP, and aspartate the 6-amino group of AMP.
- Phosphoryl transfer from ATP converts AMP and GMP to ADP and GDP. A second phosphoryl transfer from ATP forms GTP, but ADP is converted to ATP primarily by oxidative phosphorylation.
- Hepatic purine nucleotide biosynthesis is stringently regulated by the pool size of PRPP and by feedback inhibition of PRPP glutamyl amidotransferase by AMP and GMP.
- Coordinated regulation of purine and pyrimidine nucleotide biosynthesis ensures their presence in proportions appropriate for nucleic acid biosynthesis and other metabolic needs.
- Humans catabolize purines to uric acid (pK_a 5.8), present as the relatively insoluble acid at acidic pH or as its more soluble sodium urate salt at a pH near neutrality. Urate crystals are diagnostic of gout. Other disorders of purine catabolism include Lesch-Nyhan syndrome, von Gierke disease, and hypouricemias.
- Since pyrimidine catabolites are water-soluble, their overproduction does not result in clinical abnormalities. Excretion of pyrimidine precursors can, however, result from a deficiency of ornithine transcarbamoylase because excess carbamoyl phosphate is available for pyrimidine biosynthesis.

REFERENCES

- Brassier A, Ottolenghi C, Boutron A, et al: Dihydropyrimidine dehydrogenase deficiency: a still overlooked cause of recurrent acute liver failure and Reye-like syndrome. *Mol Genet Metab* 2013;109:28.
- Christopherson RI, Lyons SD, Wilson PK: Inhibitors of de novo nucleotide biosynthesis as drugs. *Acc Chem Res* 2002;35:961.
- Fu R, Jinnah HA: Genotype-phenotype correlations in Lesch-Nyhan disease: moving beyond the gene. *J Biol Chem* 2012;287:2997.
- Fu W, Li Q, Yao J, et al: Protein expression of urate transporters in renal tissue of patients with uric acid nephrolithiasis. *Cell Biochem Biophys* 2014;70:449.

- Kamal MA, Christopherson RI: Accumulation of 5-phosphoribosyl-1-pyrophosphate in human CCRF-CEM leukemia cells treated with antifolates. *Int J Biochem Cell Biol* 2004;36:957.
- Martinez J, Dugaiczky LJ, Zielinski R, et al: Human genetic disorders, a phylogenetic perspective. *J Mol Biol* 2001;308:587.
- Moyer RA, John DS: Acute gout precipitated by total parenteral nutrition. *J Rheumatol* 2003;30:849.
- Pettengill M, Robson S, Tresenriter M, et al: Soluble ecto-5'-nucleotidase (5'-NT), alkaline phosphatase, and adenosine deaminase (ADA1) activities in neonatal blood favor elevated extracellular adenosine. *J Biol Chem* 2013;288:27315.
- Scriver CR, Sly WS, Childs B, et al (editors): *The Metabolic and Molecular Bases of Inherited Disease*, 8th ed. McGraw-Hill, 2001.
- Uehara I, Kimura T, Tanigaki S, et al: Paracellular route is the major urate transport pathway across the blood-placental barrier. *Physiol Rep* 2014;20:2.
- Wu VC, Huang JW, Hsueh PR, et al: Renal hypouricemia is an ominous sign in patients with severe acute respiratory syndrome. *Am J Kidney Dis* 2005;45:88.

Nucleic Acid Structure & Function

P. Anthony Weil, PhD

OBJECTIVES

After studying this chapter, you should be able to:

- Understand the chemical monomeric and polymeric structure of the genetic material, deoxyribonucleic acid, or DNA, which is found within the nucleus of eukaryotic cells.
- Explain why genomic nuclear eukaryotic DNA is double stranded and highly negatively charged.
- Understand the outline of how the genetic information of DNA can be faithfully duplicated.
- Understand how the genetic information of DNA is transcribed, or copied into myriad, distinct forms of ribonucleic acid (RNA).
- Appreciate that one form of information-rich RNA, the so-called messenger RNA (mRNA), can be subsequently translated into proteins, the molecules that form the structures, shapes, and ultimately functions of individual cells, tissues, and organs.

BIOMEDICAL IMPORTANCE

The discovery that genetic information is coded along the length of a polymeric molecule composed of only four types of monomeric units was one of the major scientific achievements of the 20th century. This polymeric molecule, **deoxyribonucleic acid (DNA)**, is the chemical basis of heredity and is organized into genes, the fundamental units of genetic information. The basic information pathway—that is, DNA, which directs the synthesis of RNA, which in turn both directs and regulates protein synthesis—has been elucidated. Genes do not function autonomously; rather their replication and function are controlled by various gene products, often in collaboration with components of various signal transduction pathways. Knowledge of the structure and function of nucleic acids is essential in understanding genetics and many aspects of pathophysiology as well as the genetic basis of disease.

DNA CONTAINS THE GENETIC INFORMATION

The demonstration that DNA contained the genetic information was first made in 1944 in a series of experiments by Avery, MacLeod, and McCarty. They showed that the genetic determination of the character (type) of the capsule of a specific

pneumococcus could be transmitted to another of a different capsular type by introducing purified DNA from the former coccus into the latter. These authors referred to the agent (later shown to be DNA) accomplishing the change as “transforming factor.” Subsequently, this type of genetic manipulation has become commonplace. Similar experiments now are regularly performed utilizing a variety of eukaryotic cells, including human cells and mammalian embryos as recipients and molecularly cloned DNA as the donor of genetic information.

DNA Contains Four Deoxynucleotides

The chemical nature of the monomeric deoxynucleotide units of DNA—**deoxyadenylate**, **deoxyguanylate**, **deoxycytidylate**, and **thymidylate**—is described in Chapter 32. These monomeric units of DNA are held in polymeric form by 3',5'-phosphodiester bonds constituting a single strand, as depicted in **Figure 34-1**. The informational content of DNA (the genetic code) resides in the sequence in which these monomers—purine and pyrimidine deoxyribonucleotides—are ordered. The polymer as depicted possesses a polarity; one end has a 5'-hydroxyl or phosphate terminal while the other has a 3'-phosphate or hydroxyl terminal. The importance of this polarity will become evident. Since the genetic information resides in the order of the monomeric units within the polymers, there must exist a mechanism of reproducing

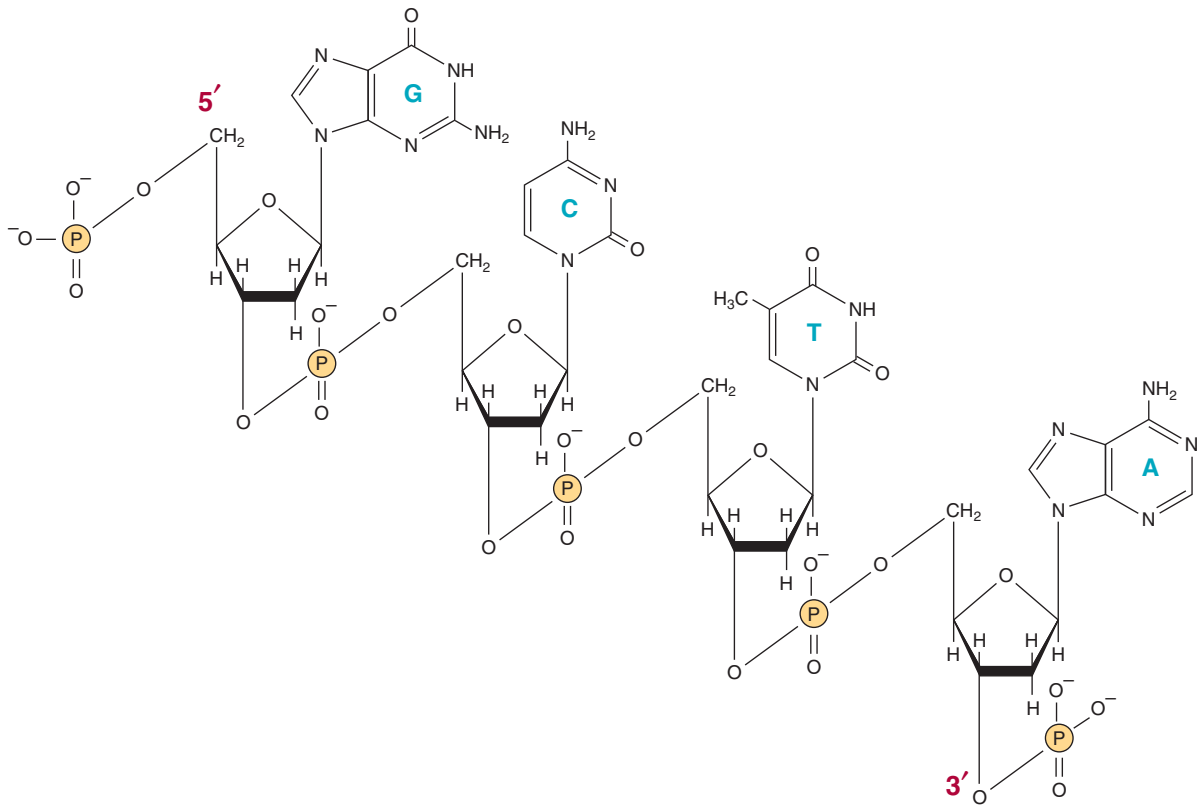

FIGURE 34-1 A segment of one strand of a DNA molecule in which the purine and pyrimidine bases guanine (G), cytosine (C), thymine (T), and adenine (A) are held together by a phosphodiester backbone between 2'-deoxyribosyl moieties attached to the nucleobases by an *N*-glycosidic bond. Note that the phosphodiester backbone is negatively charged and has a polarity (ie, a direction). Convention dictates that a single-stranded DNA sequence is written in the 5' to 3' direction (ie, pGpCpTpAp, where G, C, T, and A represent the four bases and p represents the interconnecting phosphates).

or replicating this specific information with a high degree of fidelity. That requirement, together with x-ray diffraction data from the DNA molecule generated by Franklin, and the observation of Chargaff that in DNA molecules the concentration of deoxyadenosine (A) nucleotides equals that of thymidine (T) nucleotides ($A = T$), while the concentration of deoxyguanosine (G) nucleotides equals that of deoxycytidine (C) nucleotides ($G = C$), led Watson, Crick, and Wilkins to propose in the early 1950s a model of a double-stranded DNA molecule. The model they proposed is depicted in **Figure 34-2**. The two strands of this double-stranded helix are held in register by both **hydrogen bonds** between the purine and pyrimidine bases of the respective linear molecules and by **van der Waals** and **hydrophobic interactions** between the stacked adjacent base pairs. The pairings between the purine and pyrimidine nucleotides on the opposite strands are very specific and are dependent upon hydrogen bonding of **A with T** and **G with C** (Figure 34-2).

This common form of DNA is said to be right-handed because as one looks down the double helix, the base residues form a spiral in a clockwise direction. In the double-stranded molecule, restrictions imposed by the rotation about the phosphodiester bond, the favored *anti*-configuration of the glycosidic bond (see Figure 32-5), and the predominant tautomers (see Figure 32-2) of the four bases (A, G, T, and C)

allow A to pair only with T, and G only with C, as depicted in **Figure 34-3**. This base-pairing restriction explains the earlier observation that in a double-stranded DNA molecule the content of A equals that of T and the content of G equals that of C. The two strands of the double-helical molecule, each of which possesses a **polarity**, are **antiparallel**; that is, one strand runs in the 5' to 3' direction and the other in the 3' to 5' direction. Within a particular gene in the double-stranded DNA molecules, the genetic information resides in the sequence of nucleotides on one strand, the **template strand**. This is the strand of DNA that is copied during **ribonucleic acid (RNA)** synthesis. It is sometimes referred to as the **non-coding strand**. The opposite strand is considered the **coding strand** because it matches the sequence of the RNA transcript (but containing uracil in place of thymine; Figure 34-8) that encodes the protein.

The two strands, in which opposing bases are held together by interstrand hydrogen bonds, wind around a central axis in the form of a **double helix**. In the test tube, double-stranded DNA can exist in at least six forms (A-E and Z). These different forms of DNA differ with regard to intra- and inter-strand interactions and involve structural rearrangements within the monomeric units of DNA. These rearrangements are fundamentally similar to those described for amino acids within polypeptides (eg, Figure 3-4). The B form is usually

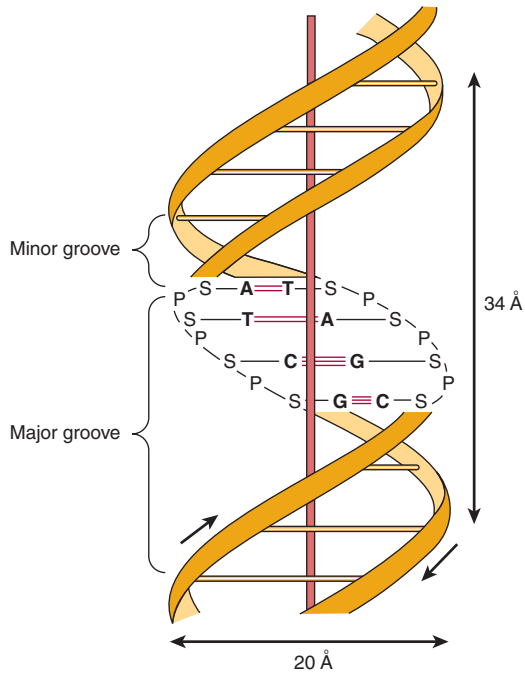

FIGURE 34-2 A diagrammatic representation of the Watson and Crick model of the double-helical structure of the B form of DNA. The horizontal arrow indicates the width of the double helix (20 Å), and the vertical arrow indicates the distance spanned by one complete turn of the double helix (34 Å). One turn of B-DNA includes 10 base pairs (bp), so the rise is 3.4 Å per bp. The central axis of the double helix is indicated by the vertical rod. The short arrows designate the polarity of the antiparallel strands. The major and minor grooves are depicted. (A, adenine; C, cytosine; G, guanine; P, phosphate; S, sugar [deoxyribose]; T, thymine.) Hydrogen bonds between A/T and G/C bases indicated by short, red, horizontal lines.

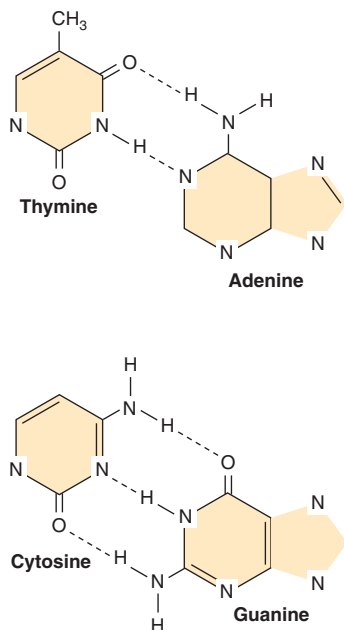

FIGURE 34-3 DNA base pairing between complementary deoxynucleotides involves the formation of hydrogen bonds. Two such H-bonds form between adenine and thymine, and three H-bonds form between cytosine and guanine. The broken lines represent H-bonds.

found under physiologic conditions (low salt, high degree of hydration). A single turn of B-DNA about the long axis of the molecule contains 10 bp. The distance spanned by one turn of B-DNA is 3.4 nm (34 Å). The width (helical diameter) of the double helix in B-DNA is 2 nm (20 Å).

As depicted in Figure 34-3, three hydrogen bonds, formed by hydrogen bonded to electronegative N or O atoms, hold the deoxyguanosine nucleotide to the deoxycytidine nucleotide, whereas the other pair, the A-T pair, is held together by two hydrogen bonds. Thus, the G-C bonds are more resistant to denaturation, or strand separation, termed “melting,” than A-T-rich regions of DNA.

The Denaturation of DNA Is Used to Analyze Its Structure

The double-stranded structure of DNA can be separated into two component strands in solution by increasing the temperature or decreasing the salt concentration. Not only do the two stacks of bases pull apart, but the bases themselves unstack while still connected in the polymer by the phosphodiester backbone. Concomitant with this denaturation of the DNA molecule is an increase in the optical absorbance of the purine and pyrimidine bases—a phenomenon referred to as **hyperchromicity** of denaturation. Because of the stacking of the bases and the hydrogen bonding between the stacks, the double-stranded DNA molecule exhibits properties of a rigid rod and in solution is a viscous material that loses its viscosity upon denaturation.

The strands of a given molecule of DNA separate over a temperature range. The midpoint is called the **melting temperature**, or T_m . The T_m is influenced by the base composition of the DNA and by the salt concentration (or other solutes, see below) of the solution. DNA rich in G-C pairs, which have three hydrogen bonds, melts at a higher temperature than that rich in A-T pairs, which have two hydrogen bonds. A 10-fold increase of monovalent cation concentration increases the T_m by 16.6°C by neutralizing the intrinsic interchain repulsion between the highly negatively charged phosphates of the phosphodiester backbone. Conversely, the organic solvent formamide, which is commonly used in recombinant DNA experiments, destabilizes hydrogen bonding between bases, thereby lowering the T_m . Formamide addition allows the strands of DNA or DNA-RNA hybrids to be separated at much lower temperatures and minimizes the phosphodiester bond breakage that can occur upon extended incubation at higher temperatures.

Renaturation of DNA Requires Base Pair Matching

Importantly, separated strands of DNA will renature or reassociate when appropriate physiologic temperature and salt conditions are achieved; this reannealing process is often referred to as **hybridization**. The rate of reassociation depends upon the concentration of the complementary strands. Reassociation of the two complementary DNA strands of a chromosome after transcription is a physiological example of renaturation (see below). At a given temperature and salt concentration, a particular

nucleic acid strand will associate tightly only with a complementary strand. Hybrid molecules will also form under appropriate conditions. For example, DNA will form a hybrid with a complementary DNA (cDNA) or with a cognate complementary RNA (eg, mRNA; see below). When hybridization is combined with gel electrophoresis techniques that separate nucleic acids by size, coupled with radioactive or fluorescent probe labeling to provide a detectable signal, the resulting analytic techniques are called **Southern (DNA/DNA)** and **Northern (RNA–DNA) blotting**, respectively. These procedures allow for very distinct, high-sensitivity identification of specific nucleic acid species from complex mixtures of DNA or RNA (see Chapter 39).

There Are Grooves in the DNA Molecule

Examination of the model depicted in Figure 34–2 reveals a **major groove** and a **minor groove** winding along the molecule parallel to the phosphodiester backbones. In these grooves, proteins often interact specifically with exposed atoms of the nucleotides (via specific hydrophobic and ionic interactions) thereby recognizing and binding to specific nucleotide sequences as well as the unique shapes formed therefrom. Binding usually occurs without disrupting the base pairing of the double-helical DNA molecule. As discussed in Chapters 36 and 38, regulatory proteins control the expression of specific genes via such interactions.

DNA Exists in Relaxed & Supercoiled Forms

In some organisms such as bacteria, bacteriophages, many DNA-containing animal viruses, as well as organelles such as mitochondria (see Figure 35–8), the ends of the DNA molecules are joined to create a closed circle with no covalently free ends. This of course does not destroy the polarity of the molecules, but it eliminates all free 3' and 5' hydroxyl and phosphoryl groups. Closed circles exist in relaxed or supercoiled forms. Supercoils are introduced when a closed circle is twisted around its own axis or when a linear piece of duplex DNA, whose ends are fixed, is twisted. This energy-requiring process puts the molecule under torsional stress, and the greater the number of supercoils, the greater the stress or torsion (test this by twisting a rubber band). **Negative supercoils** are formed when the molecule is twisted in the direction opposite from the clockwise turns of the right-handed double helix found in B-DNA. Such DNA is said to be underwound. The energy required to achieve this state is, in a sense, stored in the supercoils. The transition to another form that requires energy is thereby facilitated by the underwinding (see Figure 35–19). One such transition is strand separation, which is a prerequisite for DNA replication and transcription. Supercoiled DNA is therefore a preferred form in biologic systems. Enzymes that catalyze topologic changes of DNA are called **topoisomerases**. Topoisomerases can relax or insert supercoils, using ATP as an energy source. Homologs of this enzyme exist in all organisms and are important targets for cancer chemotherapy. Supercoils can also form within linear DNAs if particular segments of DNA

are constrained by interacting tightly with nuclear proteins that establish two boundary sites defining a topological domain.

DNA PROVIDES A TEMPLATE FOR REPLICATION & TRANSCRIPTION

The genetic information stored in the nucleotide sequence of DNA serves two purposes. It is the source of information for the synthesis of all protein molecules of the cell and organism, and it provides the information inherited by daughter cells or offspring. Both of these functions require that the DNA molecule serve as a template—in the first case for the transcription of the information into RNA and in the second case for the replication of the information into daughter DNA molecules.

When each strand of the double-stranded parental DNA molecule separates from its complement during replication, each independently serves as a template on which a new complementary strand is synthesized (**Figure 34–4**). The two

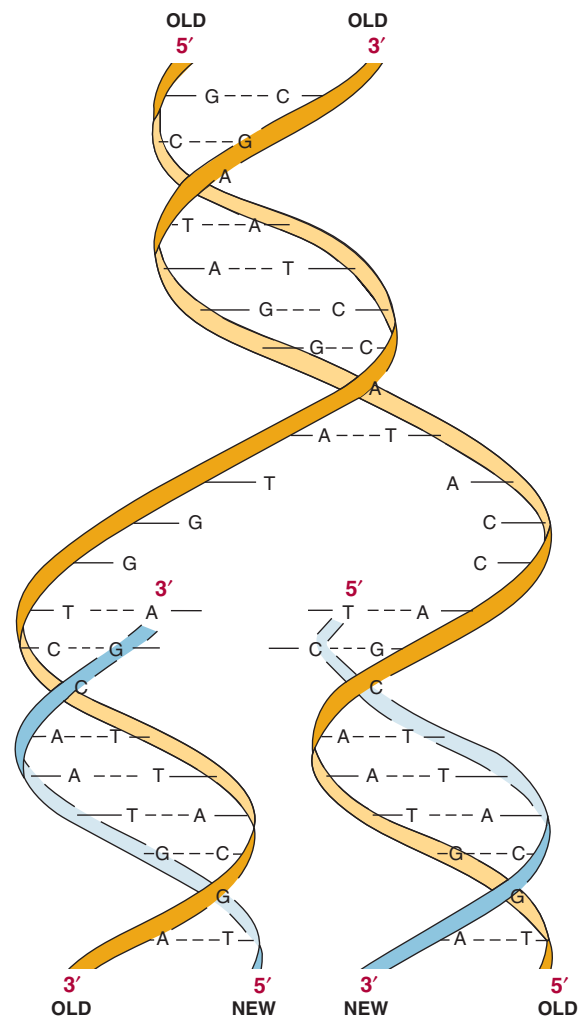

FIGURE 34–4 DNA synthesis maintains the structure of DNA. The double-stranded structure of DNA and the template function of each old parental strand (orange) on which a new complementary daughter strand (blue) is synthesized.

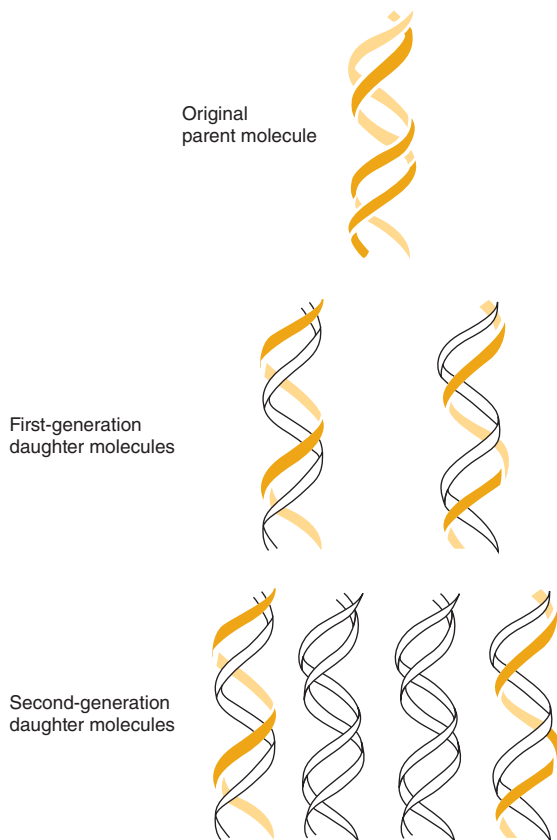

FIGURE 34-5 DNA replication is semiconservative. During a round of replication, each of the two strands of DNA is used as a template for synthesis of a new, complementary strand. The semiconservative nature of DNA replication has implications for the biochemical (see Figure 35-16), cytogenetic (see Figure 35-2) and epigenetic control of gene expression (see Figures 38-8; 38-9).

newly formed double-stranded daughter DNA molecules, each containing one strand (but complementary rather than identical) from the parent double-stranded DNA molecule, are then sorted between the two daughter cells during mitosis (Figure 34-5). Each daughter cell contains DNA molecules with information identical to that which the parent possessed; yet in each daughter cell, the DNA molecule of the parent cell has been only semiconserved.

THE CHEMICAL NATURE OF RNA DIFFERS FROM THAT OF DNA

RNA is a polymer of purine and pyrimidine ribonucleotides linked together by 3',5'-phosphodiester bonds analogous to those in DNA (Figure 34-6). Although sharing many features with DNA, RNA possesses several specific differences:

1. In RNA, the sugar moiety to which the phosphates and purine and pyrimidine bases are attached is ribose rather than the 2'-deoxyribose of DNA (see Figures 19-2 and 32-3).
2. The pyrimidine components of RNA can differ from those of DNA. Although RNA contains the ribonucleotides of

adenine, guanine, and cytosine, it does not possess thymine except in the rare case mentioned below. Instead of thymine, RNA contains the ribonucleotide of uracil.

3. RNA typically exists as a single strand, whereas DNA exists as a double-stranded helical molecule. However, given the proper complementary base sequence with opposite polarity, the single strand of RNA—as demonstrated in Figures 34-7 and 34-11—is capable of folding back on itself like a hairpin and thus acquiring double-stranded characteristics: G pairing with C, and A pairing with U.
4. Since the RNA molecule is a single strand complementary to only one of the two strands of a gene, its guanine content does not necessarily equal its cytosine content, nor does its adenine content necessarily equal its uracil content.
5. RNA can be hydrolyzed by alkali to 2', 3' cyclic diesters of the mononucleotides, compounds that cannot be formed from alkali-treated DNA because of the absence of a 2'-hydroxyl group. The alkali lability of RNA is useful both diagnostically and analytically.

Information within the single strand of RNA is contained in its sequence (“primary structure”) of purine and pyrimidine nucleotides within the polymer. The sequence is complementary to the template strand of the gene from which it was transcribed. Because of this complementarity, an RNA molecule can bind specifically via the base-pairing rules to its template DNA strand (A–T, G–C, C–G, U–A; RNA base bolded); it will not bind (“hybridize”) with the other (coding) strand of its gene. The sequence of the RNA molecule (except for U replacing T) is the same as that of the coding strand of the gene (Figure 34-8).

NEARLY ALL THE SEVERAL SPECIES OF STABLE, ABUNDANT RNAs ARE INVOLVED IN SOME ASPECT OF PROTEIN SYNTHESIS

Those cytoplasmic RNA molecules that serve as templates for protein synthesis (ie, that transfer genetic information from DNA to the protein-synthesizing machinery) are designated **mRNAs**. Many other very abundant cytoplasmic RNA molecules (**ribosomal RNAs; rRNAs**) have structural roles wherein they contribute to the formation and function of ribosomes (the organellar machinery for protein synthesis) or serve as adapter molecules (**transfer RNAs; tRNAs**) for the translation of RNA information into specific sequences of polymerized amino acids.

Interestingly, some RNA molecules have intrinsic catalytic activity. The activity of these RNA enzymes, or **ribozymes**, often involves the cleavage of a nucleic acid. Two ribozymes are the peptidyl transferase that catalyzes peptide bond formation on the ribosome, and ribozymes involved in the RNA splicing.

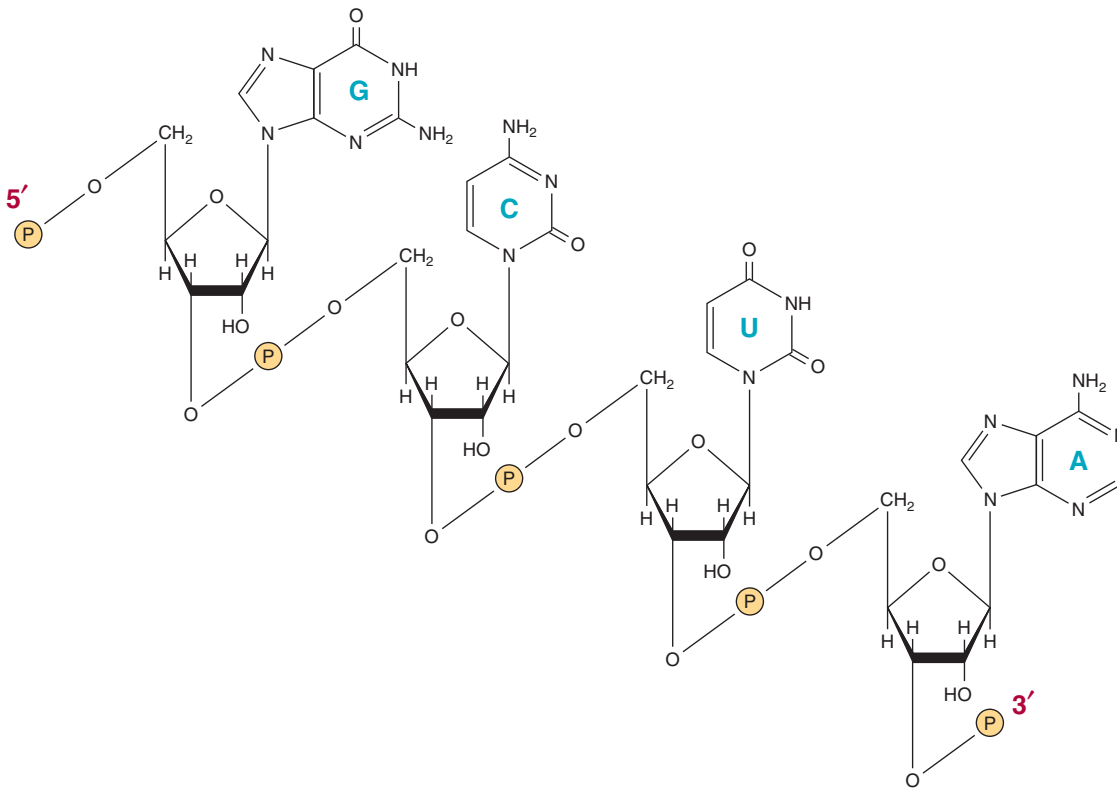

FIGURE 34-6 A segment of a ribonucleic acid (RNA) molecule in which the purine and pyrimidine bases—guanine (G), cytosine (C), uracil (U), and adenine (A)—are held together by phosphodiester bonds between ribosyl moieties attached to the nucleobases by *N*-glycosidic bonds. Note that negative charge(s) on the phosphodiester backbone are not illustrated (ie, Figure 34-1) and that the polymer has a polarity as indicated by the labeled 3'- and 5'-attached phosphates.

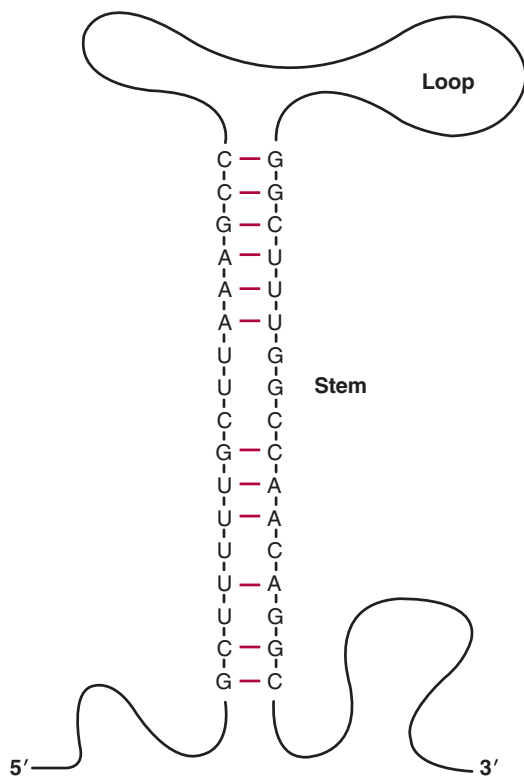

FIGURE 34-7 Diagrammatic representation of the secondary structure of a single-stranded RNA molecule in which a stem loop, or “hairpin,” has been formed. Formation of this structure is dependent upon the indicated intramolecular base pairing (colored horizontal lines between bases). Note that A forms hydrogen bonds with U in RNA.

In all eukaryotic cells, there are **small nuclear RNA (snRNA)** species that are not directly involved in protein synthesis but play pivotal roles in RNA processing, particularly mRNA processing. These relatively small molecules vary in size from 90 to about 300 nucleotides (**Table 34-1**). The properties of the several classes of cellular RNAs are detailed below.

The genetic material for some animal and plant viruses is RNA rather than DNA. Although some RNA viruses never have their information transcribed into a DNA molecule, many animal RNA viruses—specifically, the retroviruses (the human immunodeficiency, or HIV virus, for example)—are transcribed by **viral RNA-dependent DNA polymerase**, the so-called **reverse transcriptase**, to produce a double-stranded DNA copy of their RNA genome. In many cases, the resulting double-stranded DNA transcript is integrated into the host genome and subsequently serves as a template for gene expression and from which new viral RNA genomes and viral mRNAs can be transcribed. Genomic insertion of such integrating “proviral” DNA molecules can, depending on the site involved, be mutagenic, inactivating a gene or deregulating its expression (see Figure 35-11).

THERE EXIST SEVERAL DISTINCT CLASSES OF RNA

As noted above, in all prokaryotic and eukaryotic organisms, four main classes of RNA molecules exist: mRNA, tRNA, rRNA, and small RNAs. Each differs from the others by abundance, size, function, and general stability.

DNA strands:



RNA transcript: 5'—ppp AUUGUGAGCGGAUAACAAUUUCACACAGGAAACAGCUAUGACCAUG 3'

FIGURE 34–8 The relationship between the sequences of an RNA transcript and its gene, in which the coding and template strands are shown with their polarities. The RNA transcript with a 5' to 3' polarity is complementary to the template strand with its 3' to 5' polarity. Note that the sequence in the RNA transcript and its polarity is the same as that in the coding strand, except that the U of the transcript replaces the T of the gene; the initiating nucleotide of RNAs contain a terminal 5-triphosphate (ie, pppA-above).

Messenger RNA

This class is the most heterogeneous in abundance, size and stability; for example, in brewer's yeast, specific mRNAs are present in 100s/cell to, on average, ≤0.1/mRNA/cell in a genetically homogeneous population. As detailed in Chapters 36 and 38, both specific transcriptional and posttranscriptional mechanisms contribute to this large dynamic range in mRNA content. In mammalian cells, mRNA abundance likely varies over a 10⁴-fold range. All members of this RNA class function as messengers conveying the information in a gene to the protein-synthesizing machinery, where each mRNA serves as a template on which a specific sequence of amino acids is polymerized to form a specific protein molecule, the ultimate gene product (Figure 34–9).

Eukaryotic mRNAs have unique chemical characteristics. The 5' terminal of mRNA is “capped” by a 7-methylguanosine triphosphate that is linked to an adjacent 2'-O-methyl ribonucleoside at its 5'-hydroxyl through the three phosphates (Figure 34–10). The mRNA molecules frequently contain internal 6-methyladenine and other 2'-O-ribose-methylated nucleotides. The cap is involved in the recognition of mRNA by the translation machinery, and also helps stabilize the mRNA by preventing the nucleolytic attack by 5'-exonucleases. The protein-synthesizing machinery begins translating the mRNA into proteins beginning downstream of the 5' or capped terminal. The other end of mRNA molecules, the 3'-hydroxyl

terminal, has an attached, nongenetically encoded polymer of adenylate residues 20 to 250 nucleotides in length. The poly(A) “tail” at the 3'-hydroxyl terminal of mRNAs maintains the intracellular stability of the specific mRNA by preventing the attack of 3'-exonucleases and also facilitates translation (see Figure 37–7). A few mRNAs, including those for some histones, do not contain a poly(A) tail. Both the mRNA “cap” and “poly(A) tail” are added posttranscriptionally by nontemplate-directed enzymes to mRNA precursor molecules (pre-mRNA). mRNA represents 2% to 5% of total eukaryotic cellular RNA.

In mammalian cells, including cells of humans, the mRNA molecules present in the cytoplasm are not the RNA products immediately synthesized from the DNA template but must be formed by processing from the pre-mRNA before entering the cytoplasm. Thus, in mammalian nuclei, the immediate products of gene transcription (primary transcripts) are very heterogeneous and can be greater than 10- to 50-fold longer than mature mRNA molecules. As discussed in Chapter 36, pre-mRNA molecules are processed to generate the mRNA molecules, which then enter the cytoplasm to serve as templates for protein synthesis.

Transfer RNA

tRNA molecules vary in length from 74 to 95 nucleotides, like many other RNAs, are also generated by nuclear processing of a precursor molecule (see Chapter 36). The tRNA molecules

TABLE 34–1 Some of the Species of Small-Stable RNAs Found in Mammalian Cells

Name	Length (nucleotides)	Molecules per Cell	Localization
U1	165	1 × 10 ⁶	Nucleoplasm
U2	188	5 × 10 ⁵	Nucleoplasm
U3	216	3 × 10 ⁵	Nucleolus
U4	139	1 × 10 ⁵	Nucleoplasm
U5	118	2 × 10 ⁵	Nucleoplasm
U6	106	3 × 10 ⁵	Perichromatin granules
4.5S	95	3 × 10 ⁵	Nucleus and cytoplasm
7SK	280	5 × 10 ⁵	Nucleus and cytoplasm

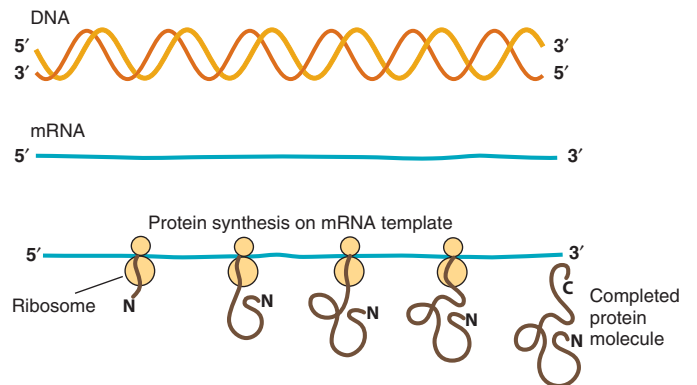

FIGURE 34–9 The expression of genetic information in DNA into the form of an mRNA transcript with 5' to 3' polarity shown. The mRNA is subsequently translated by ribosomes into a specific protein molecule that also exhibits polarity N-terminal (N) to C-terminal (C).

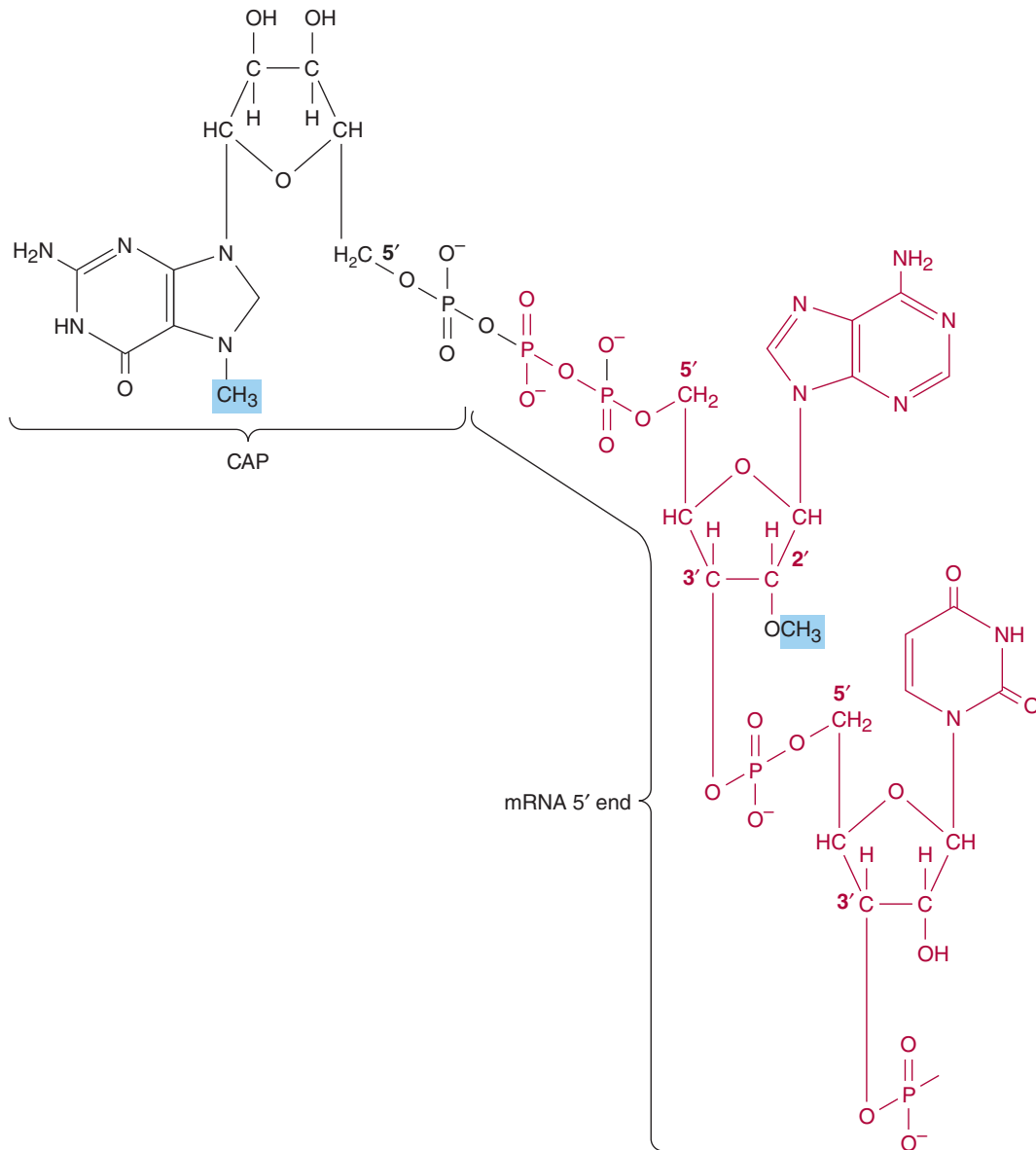

FIGURE 34-10 The cap structure attached to the 5' terminal of most eukaryotic messenger RNA molecules. A 7-methylguanosine triphosphate (black) is attached to the 5' terminal of the mRNA (red), which usually also contains a 2'-O-methylpurine nucleotide. These modifications (the cap and methyl group) are added after the mRNA is transcribed from DNA. Note that the γ - and β -phosphates of the GTP added to form the cap (black in figure) are lost upon cap addition while the γ -phosphate of the initiating nucleotide (here an A-residue; red in figure) is lost during cap addition.

serve as adapters for the translation of the information in the sequence of nucleotides of the mRNA into specific amino acids. There are at least 20 species of tRNA molecules in every cell, at least one (and often several) corresponding to each of the 20 amino acids required for protein synthesis. Although each specific tRNA differs from the others in its sequence of nucleotides, the tRNA molecules as a class have many features in common. The primary structure—that is, the nucleotide sequence—of all tRNA molecules allows extensive folding and intrastrand complementarity to generate a secondary structure that appears in two dimensions like a cloverleaf (**Figure 34-11**).

All tRNA molecules contain four main arms. The **acceptor arm** terminates in the nucleotides CpCpA_{OH}. These three

nucleotides are added post-transcriptionally by a specific nucleotidyl transferase enzyme. The tRNA-appropriate amino acid is attached, or “charged,” onto the 3'-OH group of the A moiety of the acceptor arm (see **Figure 37-1**). The **D**, **T Ψ C**, and **extra arms** help define a specific tRNA. tRNAs compose roughly 20% of total cellular RNA.

Ribosomal RNA

A ribosome is a cytoplasmic nucleoprotein structure that acts as the machinery for the synthesis of proteins from the mRNA templates. On the ribosomes, the mRNA and tRNA molecules interact to translate the information transcribed from the gene

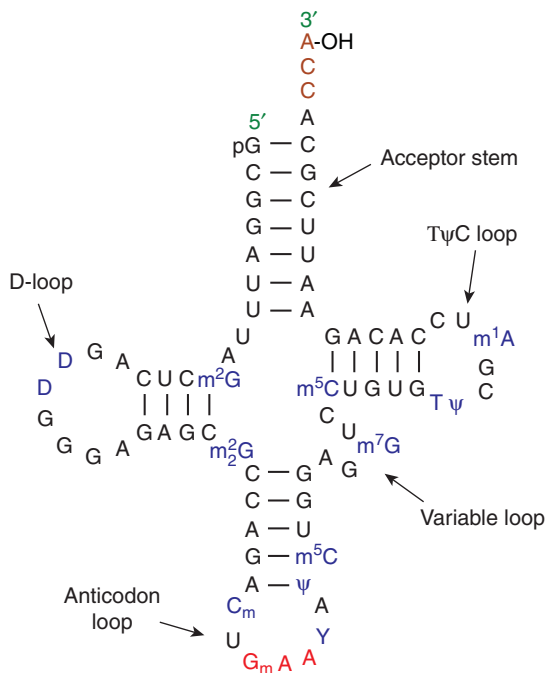

FIGURE 34-11 Linear representation of a tRNA, yeast phenylalanyl-tRNA. Straight lines represent intramolecular hydrogen bonds (A—U; G—C) between bases. The three bases of the anticodon loop are shown in red. In a charged tRNA an aminoacyl moiety is attached to the 3'-CCA_{OH} terminus (brown). Blue type highlights nontraditional nucleotides introduced by posttranslational modification, abbreviated as follows: m²G = 2-methylguanosine; D = 5,6-dihydrouridine; m₂G = N²-dimethylguanosine; C_m = O²-methylcytidine; G_m = O²-methylguanosine; T = 5-methyluridine; Y = wybutosine; ψ = pseudouridine; m⁵C = 5-methylcytidine; m⁷G = 7-methylguanosine; m¹A = 1-methyladenosine. An open source figure from Wikipedia.

during mRNA synthesis into a specific protein. During periods of active protein synthesis, many ribosomes can be associated with any mRNA molecule to form an assembly called the **polysome** (see Figure 37-7).

The components of the mammalian ribosome, which has a molecular weight of about 4.2×10^6 and a sedimentation velocity coefficient of 80S (S = **Svedberg units**, a parameter sensitive to molecular size and shape) are shown in **Table 34-2**. The mammalian ribosome contains two major nucleoprotein

subunits—a larger one with a molecular weight of 2.8×10^6 (60S) and a smaller subunit with a molecular weight of 1.4×10^6 (40S). The 60S subunit contains a 5S rRNA, a 5.8S rRNA, and a 28S rRNA; there are also more than 50 specific polypeptides. The 40S subunit is smaller and contains a single 18S rRNA and approximately 30 distinct polypeptide chains. All of the rRNA molecules except the 5S rRNA, which is independently transcribed, are processed from a single 45S precursor RNA molecule in the nucleolus (see Chapter 36). The highly methylated rRNA molecules are packaged in the nucleolus with the specific ribosomal proteins. In the cytoplasm, the ribosomes remain quite stable and capable of many translation cycles. The exact functions of the rRNA molecules in the ribosomal particle are not fully understood, but they are necessary for ribosomal assembly and also play key roles in the binding of mRNA to ribosomes and its translation. Recent studies indicate that the large rRNA component performs the peptidyl transferase activity and thus is a ribozyme. The rRNAs (28S + 18S) represent roughly 70% of total cellular RNA.

Small RNA

A large number of discrete, highly conserved, and small RNA species are found in eukaryotic cells; some are quite stable. Most of these molecules are complexed with proteins to form ribonucleoproteins and are distributed in the nucleus, the cytoplasm, or both. They range in size from 20 to 1000 nucleotides and are present in 100,000 to 1,000,000 copies per cell, collectively representing $\leq 5\%$ of cellular RNA.

Small Nuclear RNAs

snRNAs, a subset of the small RNAs (Table 34-1), are significantly involved in rRNA and mRNA processing and gene regulation. Of the several snRNAs, U1, U2, U4, U5, and U6 are involved in intron removal and the processing of mRNA precursors into mRNA (see Chapter 36). The U7 snRNA is involved in production of the correct 3' ends of histone mRNA—which lacks a poly(A) tail. 7SK RNA associates with several proteins to form a ribonucleoprotein complex, termed P-TEFb, that modulates mRNA gene transcription elongation by RNA polymerase II (see Chapter 36).

TABLE 34-2 Components of Mammalian Ribosomes

Component	Mass (MW)	Protein		RNA		
		Number	Mass	Size	Mass	Bases
40S subunit	1.4×10^6	33	7×10^5	18S	7×10^5	1900
60S subunit	2.8×10^6	50	1×10^6	5.8S	4.5×10^4	160
				28S	1.6×10^6	4700

Note: The ribosomal subunits are defined according to their sedimentation velocity in Svedberg (S) units (40S or 60S). The number of unique proteins and their total mass (MW) and the RNA components of each subunit in size (Svedberg units), mass, and number of bases are listed.

Large & Small Noncoding Regulatory RNAs: Micro-RNAs (miRNAs), Silencing RNAs (siRNAs), and Long Noncoding RNAs (lncRNAs)

One of the most exciting and unanticipated discoveries in the last decade of eukaryotic regulatory biology has been the identification and characterization of regulatory nonprotein coding RNAs (ncRNAs). NcRNAs exist in two general size classes, large (50-1000nt) and small (20-22nt). Regulatory ncRNAs have been described in most eukaryotes (see Chapter 38).

The **small ncRNAs termed miRNAs and siRNAs typically inhibit of gene expression** at the level of specific protein production by targeting mRNAs through one of several distinct mechanisms. miRNAs are generated by specific nucleolytic processing of the products of distinct genes/transcription units (see Figure 36-17). miRNA precursors, which are 5'-capped and 3'-polyadenylated, usually range in size from about 500 to 1000 nucleotides.

By contrast, siRNAs are generated by the specific nucleolytic processing of large dsRNAs that are either produced from other endogenous RNAs, or dsRNAs introduced into the cell, by for example, RNA viruses. Both **siRNAs and miRNAs typically hybridize, via the formation of RNA-RNA hybridization to their targeted mRNAs** (see Figure 38-19). To date, hundreds of distinct miRNAs and siRNAs have been described in humans; estimates suggest that there are ~1000 human miRNA-encoding genes. Given their exquisite genetic specificity both miRNAs and siRNAs represent exciting new **potential agents for therapeutic drug development**. siRNAs are frequently used to decrease or “knock-down” specific protein levels (via siRNA homology-directed mRNA degradation) in experimental contexts in the laboratory, an extremely useful and powerful alternative to gene-knockout technology (see Chapter 39). Indeed, several siRNA-based therapeutic clinical trials are in progress to test the efficacy of these novel molecules as drugs for treating human disease.

Another exciting recent discovery in the RNA realm is the identification and characterization of **long noncoding RNAs, or lncRNAs**. lncRNAs, which as their name implies, do not code for protein, and range in size from ~300 to 1000s of nucleotides in length. These RNAs are typically transcribed from the large regions of eukaryotic genomes that do not encode for protein (ie, the mRNA encoding genes). In fact transcriptome analyses indicate that **>90% of all eukaryotic genomic DNA is transcribed**. ncRNAs make up a significant portion of this transcription. ncRNAs play many roles ranging from contributing to structural aspects of chromatin to regulation of mRNA gene transcription by RNA polymerase II. Future work will further characterize this important, newly discovered class of RNA molecules.

Interestingly, bacteria also contain small, heterogeneous regulatory RNAs termed sRNAs. Bacterial sRNAs range in size from 50 to 500 nucleotides, and like eukaryotic mi/si/lncRNAs, also control a large array of genes. sRNAs often repress, but sometimes activate protein synthesis by binding to specific mRNA.

SPECIFIC NUCLEASES DIGEST NUCLEIC ACIDS

Enzymes capable of degrading nucleic acids have been recognized for many years. These nucleases can be classified in several ways. Those that exhibit specificity for DNA are referred to as **deoxyribonucleases**. Those nucleases that specifically hydrolyze RNA are **ribonucleases**. Some nucleases degrade both DNA and RNA. Within both of these classes are enzymes capable of cleaving internal phosphodiester bonds to produce either 3'-hydroxyl and 5'-phosphoryl terminals or 5'-hydroxyl and 3'-phosphoryl terminals. These are referred to as **endonucleases**. Some are capable of hydrolyzing both strands of a **double-stranded** molecule, whereas others can only cleave **single strands** of nucleic acids. Some nucleases can hydrolyze only unpaired single strands, while others are capable of hydrolyzing single strands participating in the formation of a double-stranded molecule. There exist classes of endonucleases that recognize specific sequences in DNA; the majority of these are the **restriction endonucleases**, which are important tools in molecular genetics and medical sciences. A list of some currently recognized restriction endonucleases is presented in Table 39-2.

Some nucleases are capable of hydrolyzing a nucleotide only when it is present at a terminal of a molecule; these are referred to as **exonucleases**. Exonucleases act in one direction (3' → 5' or 5' → 3') only. In bacteria, a 3' → 5' exonuclease is an integral part of the DNA replication machinery and there serves to edit—or proofread—the most recently added deoxynucleotide for base-pairing errors.

SUMMARY

- DNA consists of four bases—A, G, C, and T—that are held in linear array by phosphodiester bonds through the 3' and 5' positions of adjacent deoxyribose moieties.
- DNA is organized into two strands by the pairing of bases A to T and G to C on complementary strands. These strands form a double helix around a central axis.
- The 3×10^9 bp of DNA in humans are organized into the haploid complement of 23 chromosomes. The exact sequence of these 3 billion nucleotides defines the uniqueness of each individual.
- DNA provides a template for its own replication and thus maintenance of the genotype and for the transcription of the roughly 25,000 protein coding human genes as well as a large array of nonprotein coding regulatory ncRNAs.
- RNA exists in several different single-stranded structures, most of which are directly or indirectly involved in protein synthesis or its regulation. The linear array of nucleotides in RNA consists of A, G, C, and U, and the sugar moiety is ribose.
- The major forms of RNA include mRNA, rRNA, tRNA, and snRNAs and regulatory ncRNAs. Certain RNA molecules act as catalysts (ribozymes).

REFERENCES

- Dunkle JA, Cate JH: Ribosome structure and dynamics during translation. *Annu Rev Biophys* 2010;39:227–244.
- Green R, Noller HF: Ribosomes and translation. *Annu Rev Biochem* 1997;66:689–716.
- Guthrie C, Patterson B: Spliceosomal snRNAs. *Ann Rev Genet* 1988;22:387–419.
- Han J, Xiong J, Wang D, Fu XD: Pre-mRNA splicing: where and when in the nucleus. *Trends Cell Biol* 2011;21:336–343.
- Keene JD: Minireview: global regulation and dynamics of ribonucleic acid. *Endocrinology* 2010;151:1391–1397.
- Moore M: From birth to death: the complex lives of eukaryotic mRNAs. *Science* 2005;309:1514–1518.
- Moore PB: How should we think about the ribosome? *Annu Rev Biophys* 2012;41:1–19.
- Narla A, Ebert BL: Ribosomopathies: human disorders of ribosome dysfunction. *Blood* 2010;115:3196–3205.
- Phizicky EM, Hopper AK: tRNA biology charges to the front. *Genes Dev* 2010;24:1832–1860.
- Skalsky RL, Cullen BR: Viruses, microRNAs, and host interactions. *Annu Rev Microbiol* 2010;64:123–141.
- Teng T, Thomas G, Mercer CA: Growth control and ribosomopathies. *Curr Opin Genet Dev* 2013;63–71.
- Wang G-S, Cooper TA: Splicing in disease: disruption of the splicing code and the decoding machinery. *Nature Rev Genetics* 2007;8:749.
- Watson JD, Crick FH: Molecular structure of nucleic acids; a structure for deoxyribose nucleic acid. *Nature* 1953;171:737–738.
- Yang L, Froberg JE, Lee JT: Long noncoding RNAs: fresh perspectives into the RNA world. *Trends Biochem Sci* 2014; 39:35–43.

DNA Organization, Replication, & Repair

P. Anthony Weil, PhD

OBJECTIVES

After studying this chapter, you should be able to:

- Appreciate that the roughly 3×10^9 base pairs of DNA that compose the haploid genome of humans are divided uniquely between 23 linear DNA units, the chromosomes. Humans, being diploid, have 23 pairs of chromosomes: 22 autosomes and two sex chromosomes.
- Understand that human genomic DNA, if extended end-to-end, would be meters in length, yet still fits within the nucleus of the cell, an organelle that is only microns (μ ; 10^{-6} meters) in diameter. Such condensation in DNA length is induced following its association with the highly positively charged histone proteins resulting in the formation of a unique DNA-histone complex termed the nucleosome. Nucleosomes have DNA wrapped around the surface of an octamer of histones.
- Explain that strings of nucleosomes form along the linear sequence of genomic DNA to form chromatin, which itself can be more tightly packaged and condensed, which ultimately leads to the formation of the chromosomes.
- Appreciate that while the chromosomes are the macroscopic functional units for DNA transcription, replication, recombination, gene assortment, and cellular division, it is DNA function at the level of the individual nucleotides that composes regulatory sequences linked to specific genes that are essential for life.
- Explain the steps, phase of the cell cycle, and the molecules responsible for the replication, repair, and recombination of DNA, and understand the negative effects of errors in any of these processes upon cellular and organismal integrity and health.

BIOMEDICAL IMPORTANCE*

The genetic information in the DNA of a chromosome can be transmitted by exact replication or it can be exchanged by a number of processes, including crossing over, recombination, transposition, and conversion. These provide a means of ensuring adaptability and diversity for the organism, but when

these processes go awry, can also result in disease. A number of enzyme systems are involved in DNA replication, alteration, and repair. Mutations are due to a change in the base sequence of DNA and may result from the faulty replication, movement, or repair of DNA and occur with a frequency of about one in every 10^6 cell divisions. Abnormalities in gene products (either in RNA, protein function, or amount) can be the result of mutations that occur in transcribed protein coding, and nonprotein coding DNA, or nontranscribed regulatory-region DNA. A mutation in a germ cell is transmitted to offspring (so-called vertical transmission of hereditary disease). A number of factors, including viruses, chemicals, ultraviolet light, and ionizing radiation, increase the rate of mutation. Mutations often affect somatic cells and so are passed on to successive generations of cells, but only within an organism

*So far as is possible, the discussion in this chapter and in Chapters 36, 37, and 38 will pertain to mammalian organisms, which are, of course, among the higher eukaryotes. At times it will be necessary to refer to observations in prokaryotic organisms such as bacteria and viruses, or lower eukaryotic model systems such as *Drosophila*, *C. elegans* or yeast. However, in such cases the information will be of a kind that can be readily extrapolated to mammalian organisms.

(ie, horizontally). It is becoming apparent that a number of diseases—and perhaps most cancers—are due to the combined effects of vertical transmission of mutations as well as horizontal transmission of induced mutations.

CHROMATIN IS THE CHROMOSOMAL MATERIAL IN THE NUCLEI OF CELLS OF EUKARYOTIC ORGANISMS

Chromatin consists of very long **double-stranded DNA (dsDNA) molecules** and a nearly equal mass of rather small basic proteins termed **histones** as well as a smaller amount of **nonhistone proteins** (most of which are acidic and larger than histones) and a small quantity of **RNA**. The nonhistone proteins include enzymes involved in DNA replication and repair, and the proteins involved in RNA synthesis, processing, and transport to the cytoplasm. The dsDNA helix in each chromosome has a length that is thousands of times the diameter of the cell nucleus. One purpose of the molecules that comprise chromatin, particularly the histones, is to condense the DNA; however, it is important to note that the histones also integrally participate in gene regulation (Chapters 36, 38, and 42); indeed histones contribute importantly to all DNA-directed molecular transactions. Electron microscopic studies of chromatin have demonstrated dense spherical particles called **nucleosomes**, which are approximately 10 nm in diameter and connected by DNA filaments (**Figure 35–1**). Nucleosomes are composed of DNA wound around an octameric complex of histone molecules.

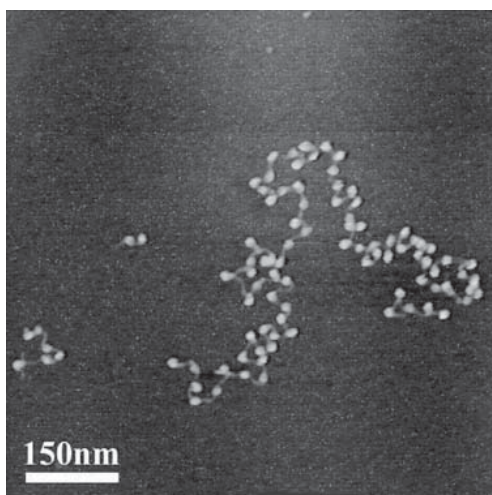

FIGURE 35–1 Electron micrograph of nucleosomes (white, ball-shaped) attached to strands of DNA (thin, gray line); see also **Figure 35–2**. (Reproduced, with permission, from Shao Z: Probing nanometer structures with atomic force microscopy. *News Physiol Sci* 1999;14:142–149. Courtesy of Professor Zhifeng Shao, University of Virginia.)

Histones Are the Most Abundant Chromatin Proteins

Histones are a small family of closely related basic proteins. **H1 histones** are the ones least tightly bound to chromatin (**Figures 35–1, 35–2, and 35–3**) and are, therefore, easily removed with a salt solution, after which chromatin becomes more soluble. The organizational unit of this soluble chromatin is the nucleosome. **Nucleosomes contain four major types of histones: H2A, H2B, H3, and H4**. The structures of all four histones—H2A, H2B, H3, and H4, the so-called core histones that form the nucleosome—have been highly conserved between species, although variants of the histones exist and are used for specialized purposes. This extreme conservation implies that the function of histones is identical in all eukaryotes and that the entire molecule is involved quite specifically in carrying out this function. The carboxyl terminal two-thirds of the histone molecules are hydrophobic, while their amino terminal thirds are particularly rich in basic amino acids. **These four core histones are subject to at least six types of covalent modification or posttranslational modifications (PTMs):** acetylation, methylation, phosphorylation, ADP-ribosylation, monoubiquitylation, and sumoylation. These histone modifications play an important role in chromatin structure and function, as illustrated in **Table 35–1**.

The histones interact with each other in very specific ways. **H3 and H4 form a tetramer** containing two molecules of each $(H3-H4)_2$, while **H2A and H2B form dimers** $(H2A-H2B)$. Under physiologic conditions, these histone oligomers associate to form the **histone octamer** of the composition $(H3-H4)_2-(H2A-H2B)_2$.

The Nucleosome Contains Histone & DNA

When the histone octamer is mixed with purified dsDNA under appropriate ionic conditions, the same x-ray diffraction pattern is formed as that observed in freshly isolated

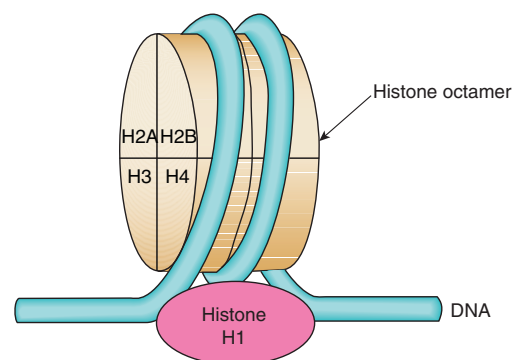

FIGURE 35–2 Model for the structure of the nucleosome, in which DNA is wrapped around the surface of a protein cylinder consisting of two each of histones H2A, H2B, H3, and H4 that form the histone octamer. The ~145 bp of DNA, consisting of 1.75 superhelical turns, are in contact with the histone octamer. The position of histone H1, when it is present, is indicated by the dashed outline at the bottom of the figure. Histone H1 interacts with DNA as it enters and exits the nucleosome.

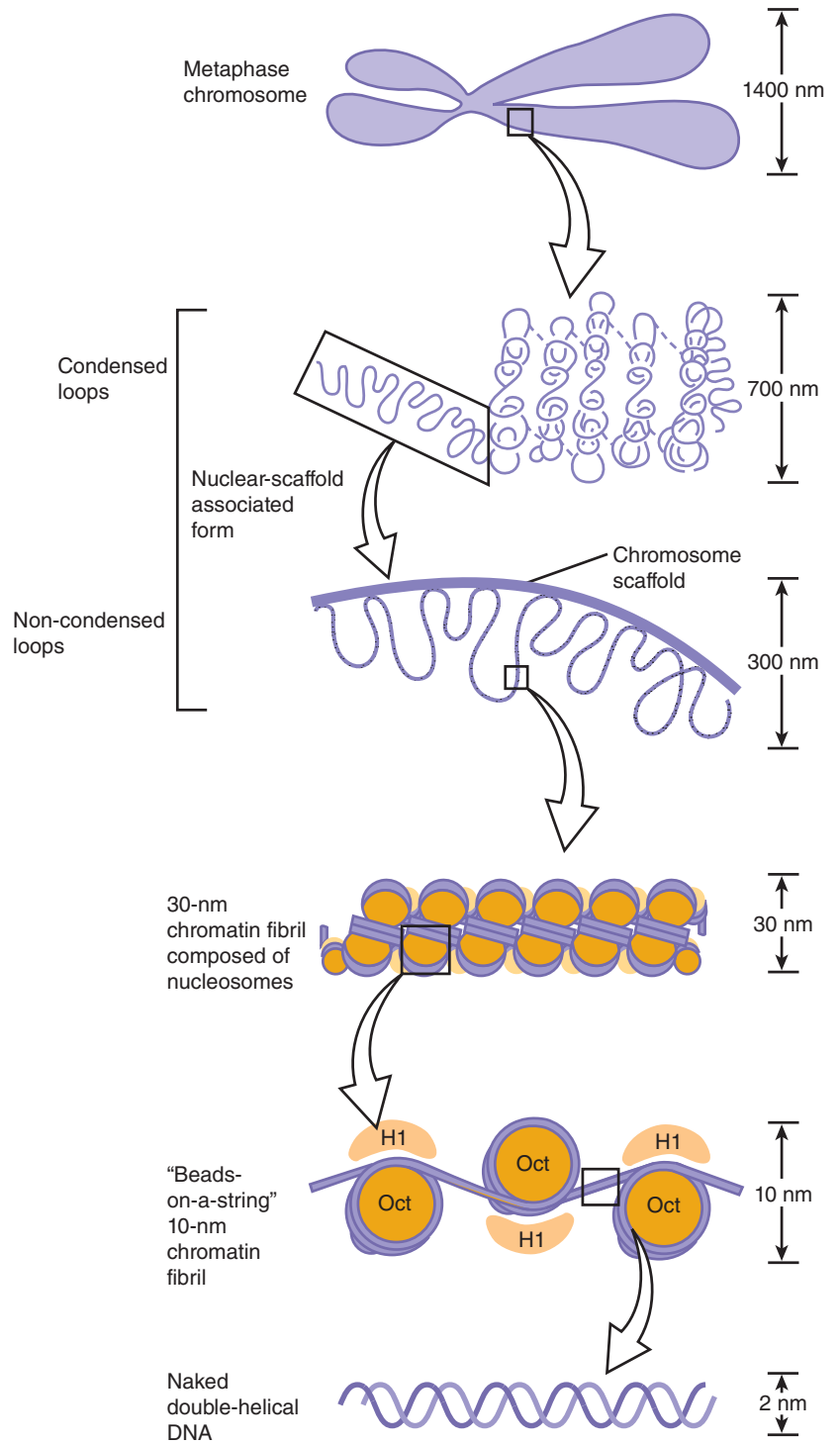

FIGURE 35-3 Shown is the extent of DNA packaging in metaphase chromosomes (top) to naked duplex DNA (bottom). Chromosomal DNA is packaged and organized at several levels as shown (see Table 35-2). Each phase of condensation or compaction and organization (bottom to top) decreases overall DNA accessibility to an extent that the DNA sequences in metaphase chromosomes are almost totally transcriptionally inert. In toto, these five levels of DNA compaction result in nearly a 10^4 -fold linear decrease in end-to-end DNA length. Complete condensation and decondensation of the linear DNA in chromosomes occur in the space of hours during the normal replicative cell cycle (see Figure 35-20).

chromatin. Biochemical and electron microscopic studies confirm the existence of reconstituted nucleosomes. Furthermore, the reconstitution of nucleosomes from DNA and histones H2A, H2B, H3, and H4 is independent of the organismal or cellular origin of the various components. Neither the histone H1 nor the nonhistone proteins are necessary for the reconstitution of the nucleosome core.

In the nucleosome, the DNA is supercoiled in a left-handed helix over the surface of the disk-shaped histone octamer (Figure 35-2). The majority of core histone proteins interact with the DNA on the inside of the supercoil without protruding, although the amino terminal tails of all the histones are thought to extend outside of this structure and are available for regulatory PTMs (see Table 35-1).

TABLE 35-1 Possible Roles of Modified Histones

1. Acetylation of histones H3 and H4 is associated with the activation or inactivation of gene transcription.
2. Acetylation of core histones is associated with chromosomal assembly during DNA replication.
3. Phosphorylation of histone H1 is associated with the condensation of chromosomes during the replication cycle.
4. ADP-ribosylation of histones is associated with DNA repair.
5. Methylation of histones is correlated with activation and repression of gene transcription.
6. Monoubiquitylation is associated with gene activation, repression, and heterochromatic gene silencing.
7. Sumoylation of histones (SUMO; small ubiquitin-related modifier) is associated with transcription repression.

The (H3–H4)₂ tetramer itself can confer nucleosome-like properties on DNA and thus has a central role in the formation of the nucleosome. The addition of two H2A–H2B dimers stabilizes the primary particle and firmly binds two additional half-turns of DNA previously bound only loosely to the (H3–H4)₂. Thus, 1.75 superhelical turns of DNA are wrapped around the surface of the histone octamer, protecting 145 to 150 bp of DNA and forming the nucleosome core particle (Figure 35–2). In chromatin, **core particles are separated by a roughly 30-bp region of DNA termed “linker.”** Most of the DNA is in a repeating series of these structures, giving the so-called beads-on-a-string appearance when examined by electron microscopy (see Figure 35–1).

In vivo the assembly of nucleosomes is mediated by one of several nuclear chromatin assembly factors facilitated by histone chaperones, a group of proteins that exhibit high-affinity histone binding. As the nucleosome is assembled, histones are released from the histone chaperones. Nucleosomes appear to exhibit preference for certain regions on specific DNA molecules, but the basis for this nonrandom distribution, termed **phasing**, is not yet completely understood. Phasing is likely related both to the relative physical flexibility of particular nucleotide sequences to accommodate the regions of kinking within the supercoil, as well as the presence of other DNA-bound factors that limit the sites of nucleosome deposition.

HIGHER ORDER STRUCTURES PROVIDE FOR THE COMPACTION OF CHROMATIN

Electron microscopy of chromatin reveals two higher orders of structure—the 10-nm fibril and the 30-nm chromatin fiber—beyond that of the nucleosome itself. The disk-like nucleosome structure has a 10-nm diameter and a height of

5 nm. The **10-nm fibril** consists of nucleosomes arranged with their edges separated by a small distance (30 bp of linker DNA) with their flat faces parallel to the fibril axis (Figure 35–3). The 10-nm fibril is probably further supercoiled with six or seven nucleosomes per turn to form the **30-nm chromatin fiber** (Figure 35–3). Each turn of the supercoil is relatively flat, and the faces of the nucleosomes of successive turns would be nearly parallel to each other. H1 histones appear to stabilize the 30-nm fiber, but their position and that of the variable length linker DNA are not clear. It is probable that nucleosomes can form a variety of packed structures. In order to form a mitotic chromosome, the 30-nm fiber must be compacted in length another 100-fold (see below).

In **interphase chromosomes**, chromatin fibers appear to be organized into 30,000 to 100,000 bp **loops or domains** anchored in a **scaffolding**, or supporting matrix within the nucleus, the so-called **nuclear matrix**. Within these domains, some DNA sequences may be located nonrandomly. It has been suggested that each looped domain of chromatin corresponds to one or more separate genetic functions, containing both coding and noncoding regions of the cognate gene or genes. This nuclear architecture is likely dynamic, having important regulatory effects upon gene regulation. Recent data suggest that certain genes or gene regions are mobile within the nucleus, moving obligatorily to discrete loci within the nucleus upon activation. Further work will determine what molecular mechanisms are responsible.

SOME REGIONS OF CHROMATIN ARE “ACTIVE” & OTHERS ARE “INACTIVE”

Generally, every cell of an individual metazoan organism contains the same genetic information. Thus, the differences between cell types within an organism must be explained by differential expression of the common genetic information. Chromatin containing active genes (ie, transcriptionally or potentially transcriptionally active chromatin) has been shown to differ in several ways from that of inactive regions. The nucleosome structure of active chromatin appears to be altered, sometimes quite extensively, in highly active regions. DNA in active chromatin contains large regions (about 100,000 bases long) that are relatively more **sensitive to digestion by a nuclease** such as DNase I. DNase I makes single-strand cuts in nearly any segment of DNA (ie, low-sequence specificity). It will digest DNA that is not protected, or bound by protein, into its component deoxy-nucleotides. The sensitivity to DNase I of active chromatin regions reflects only a potential for transcription rather than transcription itself and in several systems can be correlated with a relative lack of 5-methyldeoxycytidine (meC) in the DNA, and particular histone variants and/or histone PTMs (phosphorylation, acetylation, etc; see Table 35–1).

Within the large regions of active chromatin there exist shorter stretches of 100 to 300 nucleotides that exhibit an even greater (another 10-fold) sensitivity to DNase I. These **hypersensitive sites** probably result from a structural conformation that favors access of the nuclease to the DNA. These regions are often located immediately upstream from the active gene and are the location of interrupted nucleosomal structure caused by the binding of nonhistone regulatory transcription factor proteins (enhancer binding transcriptional activator proteins; see Chapters 36 and 38). In many cases, it seems that if a gene is capable of being transcribed, it very often has a DNase-hypersensitive site(s) in the chromatin immediately upstream. As noted above, nonhistone regulatory proteins involved in transcription control and those involved in maintaining access to the template strand lead to the formation of hypersensitive sites. Such sites often provide the first clue about the presence and location of a transcription control element.

By contrast, transcriptionally inactive chromatin is densely packed during interphase as observed by electron microscopic studies and is referred to as **heterochromatin**; transcriptionally active chromatin stains less densely and is referred to as **euchromatin**. Generally, euchromatin is replicated earlier than heterochromatin in the mammalian cell cycle (see below). The chromatin in these regions of inactivity is often high in meC content, and histones therein contain relatively lower levels of certain “activating” covalent modifications and higher levels of “repressing” histone PTMs.

There are two types of heterochromatin: constitutive and facultative. **Constitutive heterochromatin** is always condensed and thus essentially inactive. It is found in the regions near the chromosomal centromere and at chromosomal ends (telomeres). **Facultative heterochromatin** is at times condensed, but at other times it is actively transcribed and, thus, uncondensed and appears as euchromatin. Of the two members of the X chromosome pair in mammalian females, one X chromosome is almost completely inactive transcriptionally and is heterochromatic. However, the heterochromatic X chromosome decondenses during gametogenesis and becomes transcriptionally active during early embryogenesis—thus, it is facultative heterochromatin.

Certain cells of insects, for example, *Chironomus* and *Drosophila*, contain giant chromosomes that have been replicated for multiple cycles without separation of daughter chromatids. These copies of DNA line up side by side in precise register and produce a banded chromosome containing regions of condensed chromatin and lighter bands of more extended chromatin. Transcriptionally active regions of these **polytene chromosomes** are especially decondensed into “puffs” that can be shown to contain the enzymes responsible for transcription and to be the sites of RNA synthesis (Figure 35-4). Using highly sensitive fluorescently labeled hybridization probes, specific gene sequences can be mapped, or “painted,” within the nuclei of human cells, even without polytene chromosome formation, using FISH (fluorescence in situ hybridization; see Chapter 39) techniques.

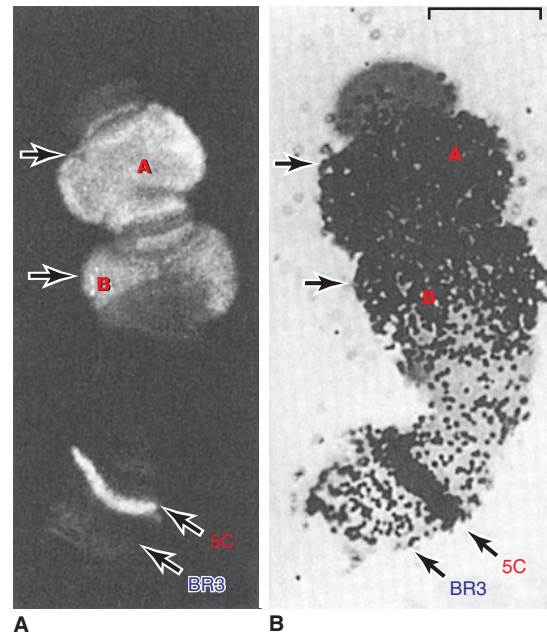

FIGURE 35-4 Illustration of the tight correlation between the presence of RNA polymerase II (Table 36-2) and messenger RNA synthesis. A number of genes, labeled A, B (top), and 5C, but not genes at locus (band) BR3 (5C, BR3, bottom) are activated when midge fly *Chironomus tentans* larvae are subjected to heat shock (39°C for 30 minutes). (A) Distribution of RNA polymerase II in isolated chromosome IV from the salivary gland (at arrows). The enzyme was detected by immunofluorescence using a fluorescently labeled antibody directed against the polymerase. The 5C and BR3 are specific bands of chromosome IV, and the arrows indicate puffs. (B) Autoradiogram of a chromosome IV that was incubated in ^3H -uridine to label the RNA. Note the correspondence of the immunofluorescence and presence of the radioactive RNA (black dots). Bar = 7 μm . (Reproduced, with permission, from Sass H: RNA polymerase B in polytene chromosomes. Cell 1982;28:274. Copyright © 1982. Reprinted with permission from Elsevier.)

DNA IS ORGANIZED INTO CHROMOSOMES

At metaphase, mammalian **chromosomes** possess a twofold symmetry, with the identical duplicated **sister chromatids** connected at a **centromere**, the relative position of which is characteristic for a given chromosome (Figure 35-5). The centromere is an adenine-thymine (A-T)-rich region containing repeated DNA sequences that range in size from 10^2 (brewers' yeast) to 10^6 (mammals) **base pairs (bp)**. Metazoan centromeres are bound by nucleosomes containing the histone H3 variant protein CENP-A and other specific centromere-binding proteins. This complex, called the **kinetochore**, provides the anchor for the mitotic spindle. It thus is an essential structure for chromosomal segregation during mitosis.

The ends of each chromosome contain structures called **telomeres**. **Telomeres consist of short TG-rich repeats**. Human telomeres have a variable number of repeats of the sequence 5'-TTAGGG-3', which can extend for several kilobases. **Telomerase**, a multisubunit RNA template-containing complex

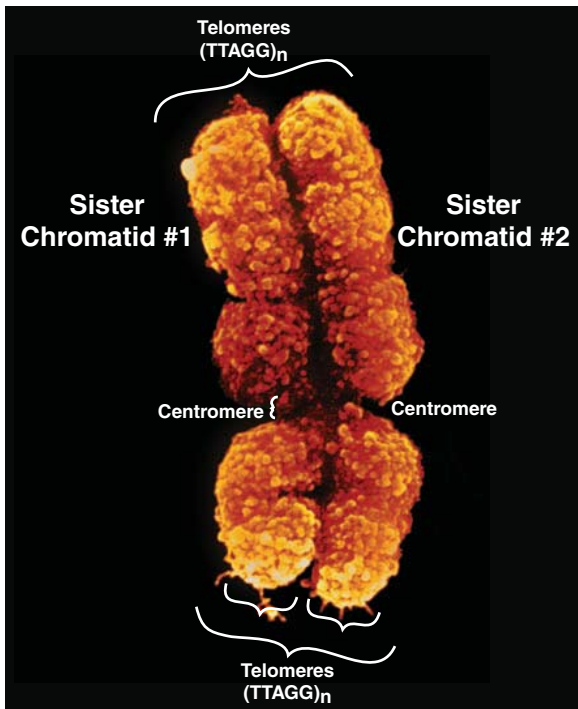

FIGURE 35-5 The two sister chromatids of mitotic human chromosome 12. The location of the A+T-rich centromeric region connecting sister chromatids is indicated, as are two of the four telomeres residing at the very ends of the chromatids that are attached one to the other at the centromere. (Courtesy of Biophoto Associates/Photo Researchers, Inc.)

related to viral RNA-dependent DNA polymerases (reverse transcriptases), is the enzyme responsible for telomere synthesis and thus for maintaining the length of the telomere. Since telomere shortening has been associated with both malignant transformation and aging (see Figure 54-7), this enzyme has become an attractive target for cancer chemotherapy and drug development

TABLE 35-2 The Packing or Compaction Ratios of Each of the Orders of DNA Structure

Chromatin Form	Packing Ratio
Naked double-helical DNA	~1.0
10-nm fibril of nucleosomes	7-10
30-nm chromatin fiber of superhelical nucleosomes	40-60
Condensed metaphase chromosome loops	8000

(see Figure 55-17). Each sister chromatid contains one dsDNA molecule. During interphase, the packing of the DNA molecule is less dense than it is in the condensed chromosome during metaphase. Metaphase chromosomes are nearly completely transcriptionally inactive.

The human haploid genome consists of about 3×10^9 bp and about 1.7×10^7 nucleosomes. Thus, each of the 23 chromatids in the human haploid genome would contain on the average 1.3×10^8 nucleotides in one dsDNA molecule. Therefore, the length of each DNA molecule must be compressed about 8000-fold to generate the structure of a condensed metaphase chromosome. In metaphase chromosomes, the 30-nm chromatin fibers are also folded into a series of **looped domains**, the proximal portions of which are anchored to the nuclear matrix, likely through interactions with proteins termed **lamins** that constitute **integral components of the inner nuclear membrane** within the nucleus (Figures 35-3 and 49-4). The packing ratios of each of the orders of DNA structure are summarized in Table 35-2. The packaging of nucleoproteins within chromatids is not random, as evidenced by the characteristic patterns observed when chromosomes are stained with specific dyes such as quinacrine or Giemsa stain (Figure 35-6).

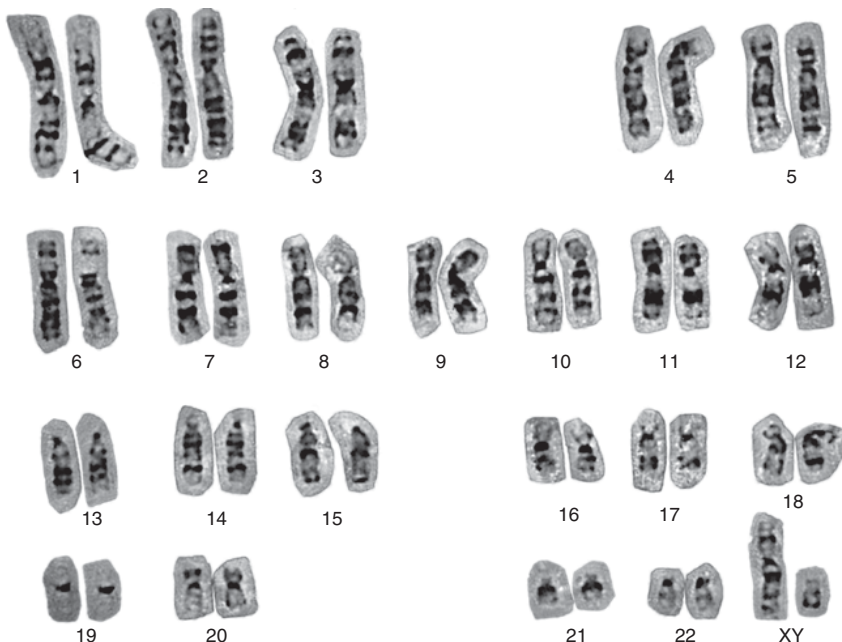

FIGURE 35-6 A human karyotype (of a man with a normal 46,XY constitution), in which the metaphase chromosomes have been stained by the Giemsa method and aligned according to the Paris Convention. (Courtesy of H Lawce and F Conte.)

From individual to individual within a single species, the pattern of staining (banding) of the entire chromosome complement is highly reproducible; nonetheless, it differs significantly between species, even those closely related. Thus, the packaging of the nucleoproteins in chromosomes of higher eukaryotes must in some way be dependent upon species-specific characteristics of the DNA molecules.

A combination of specialized staining techniques and high-resolution microscopy has allowed cytogeneticists to quite precisely map many genes to specific regions of mouse and human chromosomes. With the recent elucidation of the human and mouse genome sequences (among others), it has become clear that many of these visual mapping methods were remarkably accurate.

Coding Regions Are Often Interrupted by Intervening Sequences

The **protein coding regions of DNA**, the transcripts of which ultimately appear in the cytoplasm as single mRNA molecules, are usually **interrupted in the eukaryotic genome by large intervening sequences of nonprotein-coding DNA**. Accordingly, the **primary transcripts of DNA, mRNA precursors** (originally termed **hnRNA** because this species of RNA was quite heterogeneous in size [length] and mostly restricted to the nucleus), contain noncoding intervening

sequences of RNA that must be removed in a process which also joins together the appropriate coding segments to form the mature mRNA. Most coding sequences for a single mRNA are interrupted in the genome (and thus in the primary transcript) by at least one—and in some cases as many as 50—noncoding intervening sequences (**introns**). In most cases, the introns are much longer than the coding regions (**exons**). The processing of the primary transcript, which involves precise removal of introns and splicing of adjacent exons, is described in Chapter 36.

The function of the intervening sequences, or introns, is not totally clear. However, mRNA precursor molecules can be differentially spliced thereby increasing the number of distinct (yet related) proteins produced by a single gene and its corresponding primary mRNA gene transcript. Introns may also serve to separate functional domains (exons) of coding information in a form that permits genetic rearrangement by recombination to occur more rapidly than if all coding regions for a given genetic function were contiguous. Such an enhanced rate of genetic rearrangement of functional domains might allow more rapid evolution of biologic function. In some instances other protein-coding or noncoding RNAs are localized within the intronic DNA of certain genes (see Chapter 34). The relationships among chromosomal DNA, gene clusters on the chromosome, the exon–intron structure of genes, and the final mRNA product are illustrated in **Figure 35–7**.

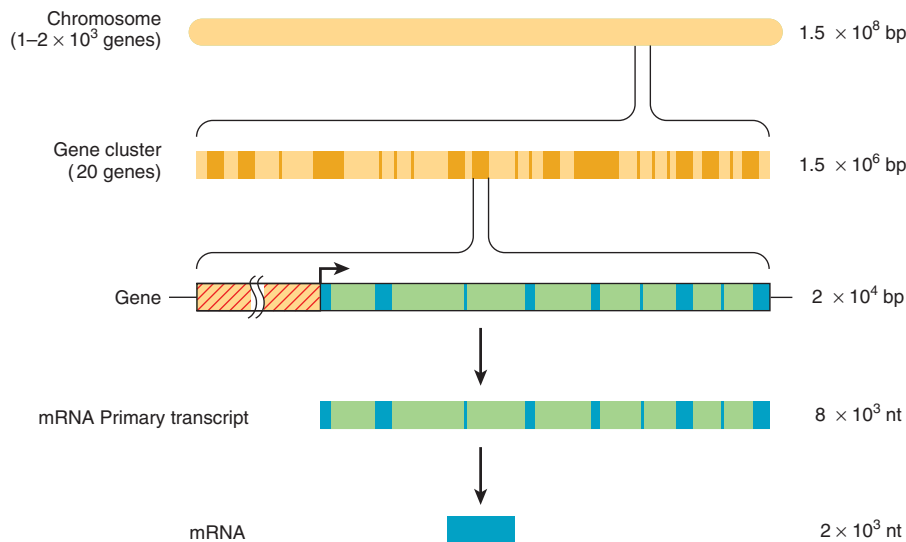

FIGURE 35–7 The relationship between chromosomal DNA and mRNA. The human haploid DNA complement of 3×10^9 bp is unequally distributed between 23 chromosomes (see Figure 35–6). Genes are often clustered on these chromosomes. An average gene is 2×10^4 bp in length, including the regulatory region (red-hatched area), which is often located at the 5' end of the gene. The regulatory region is shown here as being adjacent to the transcription initiation site (arrow). Most eukaryotic genes have alternating exons and introns. In this example, there are nine exons (blue colored areas) and eight introns (green colored areas). The introns are removed from the primary transcript by processing reactions, and the exons are ligated together in sequence to form the mature mRNA through a process termed RNA splicing. (nt, nucleotides.)

THE EXACT FUNCTION OF MUCH OF THE MAMMALIAN GENOME IS NOT WELL UNDERSTOOD

The haploid genome of each human cell consists of 3×10^9 bp of DNA subdivided into 23 chromosomes. The entire haploid genome contains sufficient DNA to code for nearly 1.5 million average-sized genes. However, studies of mutation rates and of the complexities of the genomes of higher organisms strongly suggest that humans have significantly fewer than 100,000 proteins encoded by the ~1% of the human genome that is composed of exonic DNA. Indeed current estimates suggest there are about 25,000 or less protein-coding genes in humans. This implies that most of the DNA is nonprotein coding—that is, its information is never translated into an amino acid sequence of a protein molecule. Certainly, some of the excess DNA sequences serve to regulate the expression of genes during development, differentiation, and adaptation to the environment, either by serving as binding sites for regulatory proteins or by encoding regulatory ncRNAs. Some excess clearly makes up the intervening sequences or introns that split the coding regions of genes, and another portion of the excess appears to be composed of many families of repeated sequences for which clear functions have not yet been defined, though some small RNAs transcribed from these repeats can modulate transcription, either directly by interacting with the transcription machinery or indirectly by affecting the activity of the chromatin template. Interestingly, the ENCODE Project Consortium (see Chapters 10 and 39) has shown that most of the genomic sequence was indeed transcribed albeit at a low level, a large fraction of this transcription appears to generate the lncRNAs (see Chapter 34). Further research will elucidate the role(s) played by such transcripts.

The DNA in a eukaryotic genome can be divided into different “sequence classes.” These are unique-sequence DNA, or nonrepetitive DNA and repetitive-sequence DNA. In the haploid genome, unique-sequence DNA generally includes the single copy genes that code for proteins. The repetitive DNA in the haploid genome includes sequences that vary in copy number from 2 to as many as 10^7 copies per cell.

More Than Half the DNA in Eukaryotic Organisms Is in Unique or Nonrepetitive Sequences

This estimation (and the distribution of repetitive-sequence DNA) is based on a variety of DNA–RNA hybridization techniques and, more recently, on direct DNA sequencing. Similar techniques are used to estimate the number of active genes in a population of unique-sequence DNA. In brewers’ yeast (*Saccharomyces cerevisiae*, a lower eukaryote), about two-thirds of its 6200 genes are expressed, but only ~1/5 are required for viability under laboratory growth conditions. In typical tissues in a higher eukaryote (eg, mammalian liver and kidney), between 10,000 and 15,000 genes are actively

expressed. Different combinations of genes are expressed in each tissue, of course, and how this is accomplished is one of the major unanswered questions in biology.

In Human DNA, at Least 30% of the Genome Consists of Repetitive Sequences

Repetitive-sequence DNA can be broadly classified as moderately repetitive or as highly repetitive. The highly repetitive sequences consist of 5 to 500 base pair lengths repeated many times in tandem. These sequences are often clustered in centromeres and telomeres of the chromosome and some are present in about 1 to 10 million copies per haploid genome. The majority of these sequences are transcriptionally inactive and some of these sequences play a structural role in the chromosome (Figure 35–5; see Chapter 39).

The moderately repetitive sequences, which are defined as being present in numbers of less than 10^6 copies per haploid genome, are not clustered but are interspersed with unique sequences. In many cases, these long interspersed repeats are transcribed by RNA polymerase II and contain caps indistinguishable from those on mRNA.

Depending on their length, moderately repetitive sequences are classified as **long interspersed repeat sequences (LINEs)** or **short interspersed repeat sequences (SINEs)**. Both types appear to be **retroposons**; that is, they arose from movement from one location to another (**transposition**) through an RNA intermediate by the action of reverse transcriptase that transcribes an RNA template into DNA. Mammalian genomes contain 20,000 to 50,000 copies of the 6 to 7 kbp LINEs. These represent species-specific families of repeat elements. SINEs are shorter (70–300 bp), and there may be more than 100,000 copies per genome. Of the SINEs in the human genome, one family, the **Alu family**, is present in about 500,000 copies per haploid genome and accounts for ~10% of the human genome. Members of the human Alu family and their closely related analogs in other animals are transcribed as integral components of mRNA precursors or as discrete RNA molecules, including the well-studied 4.5S RNA and 7S RNA. These particular family members are highly conserved within a species as well as between mammalian species. Components of the short interspersed repeats, including the members of the Alu family, may be mobile elements, capable of jumping into and out of various sites within the genome (see below). These transposition events can have disastrous results, as exemplified by the insertion of Alu sequences into a gene, which, when so mutated, causes neurofibromatosis. Additionally, Alu B1 and B2 SINE RNAs have been shown to regulate mRNA production at the levels of transcription and mRNA splicing.

Microsatellite Repeat Sequences

One category of repeat sequences exists as both dispersed and grouped tandem arrays. The sequences consist of 2 to 6 bp repeated up to 50 times. These **microsatellite sequences** most

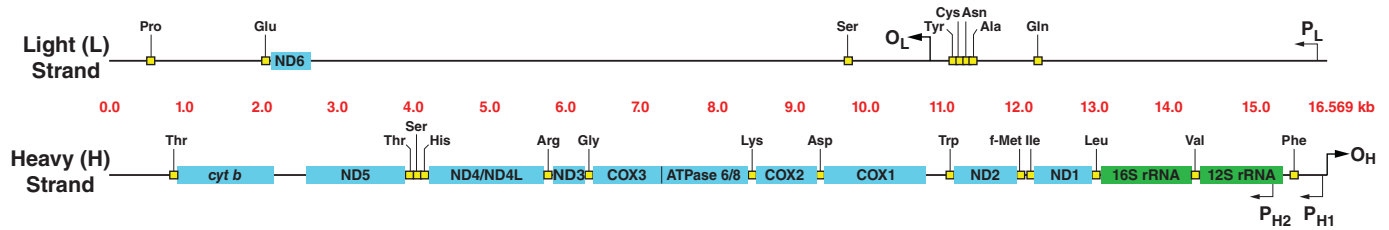

FIGURE 35-8 Map of human mitochondrial genes. The maps represent the so-called light (L; upper) and heavy (H; lower) strands of the 16,569 base pair linearized mitochondrial (mt) DNA. The maps show the genes encoding subunits of NADH-coenzyme Q oxidoreductase (ND1 through ND6), cytochrome *c* oxidase (COX1 through COX3), cytochrome *b* (*cyt b*), ATP synthase (ATPase 6 and 8) and the 12S and 16S mitochondrial rRNAs. mttransfer RNA (tRNA) encoding genes are denoted by small yellow boxes and the 3-letter code indicating the cognate amino acids which they specify during mt translation. The origin of heavy-strand (O_H), and light-strand (O_L) DNA replication, as well as the promoters for the initiation of heavy-strand (P_{H1} and P_{H2}), and light-strand (P_L) transcription are indicated by arrows and letters (see also Table 57-3). Figure generated using *Homo sapiens* mitochondrion, complete genome; Sequence: NCBI Reference NC_012920.1 and annotations therein.

commonly are found as dinucleotide repeats of AC on one strand and TG on the opposite strand, but several other forms occur, including CG, AT, and CA. The AC repeat sequences occur at 50,000 to 100,000 locations in the genome. At any locus, the number of these repeats may vary on the two chromosomes, thus providing heterozygosity of the number of copies of a particular microsatellite number in an individual. This is a heritable trait, and because of their number and the ease of detecting them using the **polymerase chain reaction (PCR)** (see Chapter 39), such repeats are useful in constructing genetic linkage maps. Most genes are associated with one or more microsatellite markers, so the relative position of genes on chromosomes can be assessed, as can the association of a gene with a disease. Using PCR, a large number of family members can be rapidly screened for a certain **microsatellite polymorphism**. The association of a specific polymorphism with a gene in affected family members—and the lack of this association in unaffected members—may be the first clue about the genetic basis of a disease.

Trinucleotide sequences that increase in number (microsatellite instability) can cause disease. The unstable (CGG)_n repeat sequence is associated with the fragile X syndrome. Other trinucleotide repeats that undergo dynamic mutation (usually an increase) are associated with Huntington's chorea (CAG), myotonic dystrophy (CTG), spinobulbar muscular atrophy (CAG), and Kennedy disease (CAG).

ONE PERCENT OF CELLULAR DNA IS IN MITOCHONDRIA

The majority of the polypeptides in mitochondria (about 54 out of 67) are encoded by nuclear genes, while the rest are coded by genes found in mitochondrial (mt) DNA. Human mitochondria contains 2 to 10 copies of a small circular ~16 kbp dsDNA molecule that makes up approximately 1% of total cellular DNA. This mtDNA codes for mt-specific ribosomal and transfer

RNAs and for 13 proteins that play key roles in the respiratory chain (see Chapter 13). The linearized structural map of the human mitochondrial genes is shown in **Figure 35-8**. Some of the features of mtDNA are shown in **Table 35-3**.

An important feature of human mitochondrial mtDNA is that—because all mitochondria are contributed by the ovum during zygote formation—it is transmitted by maternal non-mendelian inheritance. Thus, in diseases resulting from mutations of mtDNA, an affected mother would in theory pass the disease to all of her children but only her daughters would transmit the trait. However, in some cases, deletions in mtDNA

TABLE 35-3 Major Features of Human Mitochondrial DNA

• Is circular, double-stranded, and composed of heavy (H) and light (L) chains or strands
• Contains 16,569 bp
• Encodes 13 protein subunits of the respiratory chain (of a total of about 67) Seven subunits of NADH dehydrogenase (complex I) Cytochrome <i>b</i> of complex III Three subunits of cytochrome oxidase (complex IV) Two subunits of ATP synthase
• Encodes large (16S) and small (12S) mt ribosomal RNAs
• Encodes 22 mt tRNA molecules
• Genetic code differs slightly from the standard code UGA (standard stop codon) is read as Trp AGA and AGG (standard codons for Arg) are read as stop codons
• Contains very few untranslated sequences
• High mutation rate (5-10 times that of nuclear DNA)
• Comparisons of mtDNA sequences provide evidence about evolutionary origins of primates and other species

Source: Adapted from Harding AE: Neurological disease and mitochondrial genes. *Trends Neurol Sci* 1991;14:132. Copyright © 1991. Reprinted with permission from Elsevier.

occur during oogenesis and thus are not inherited from the mother. A number of diseases have now been shown to be due to mutations of mtDNA. These include a variety of myopathies, neurologic disorders, and some forms of diabetes mellitus.

GENETIC MATERIAL CAN BE ALTERED & REARRANGED

An alteration in the sequence of purine and pyrimidine bases in a gene due to a change—a removal or an insertion—of one or more bases may result in an altered gene product or alteration of gene expression if nonprotein coding DNA is involved. Such alteration in the genetic material results in a **mutation** whose consequences are discussed in detail in Chapter 37.

Chromosomal Recombination Is One Way of Rearranging Genetic Material

Genetic information can be exchanged between similar or homologous chromosomes. The exchange, or **recombination** event, occurs primarily during meiosis in mammalian cells and requires alignment of homologous metaphase chromosomes, an alignment that almost always occurs with great exactness. A process of crossing over occurs as shown in **Figure 35–9**.

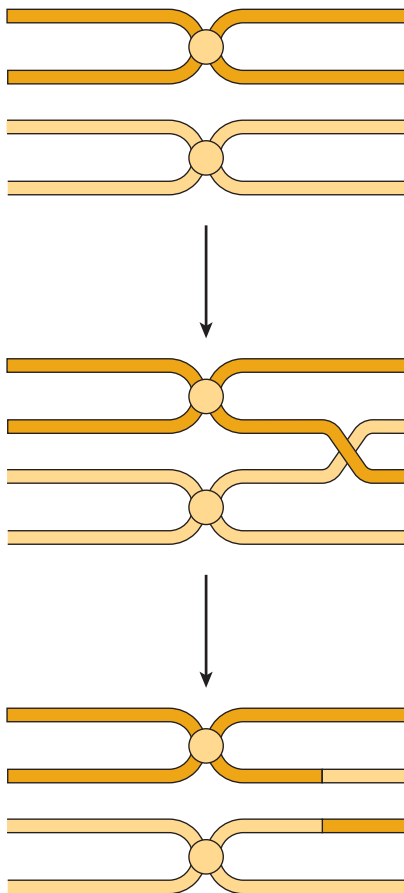

FIGURE 35–9 The process of crossing over between homologous metaphase chromosomes to generate recombinant chromosomes. See also Figure 35–12.

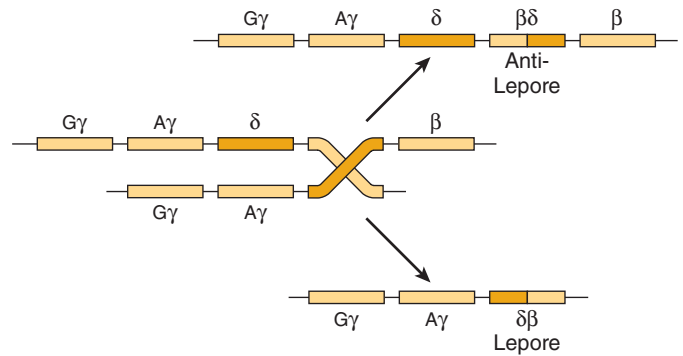

FIGURE 35–10 The process of unequal crossover in the region of the mammalian genome that harbors the structural genes encoding hemoglobins and the generation of the unequal recombinant products hemoglobin delta-beta Lepore and beta-delta anti-Lepore. The examples given show the locations of the crossover regions within amino acid coding regions of the indicated genes (ie, β and δ globin genes). (Redrawn and reproduced, with permission, from Clegg JB, Weatherall DJ: β^0 Thalassemia: time for a reappraisal? *Lancet* 1974;2:133. Copyright © 1974. Reprinted with permission from Elsevier.)

This usually results in an equal and reciprocal exchange of genetic information between homologous chromosomes. If the homologous chromosomes possess different alleles of the same genes, the crossover may produce noticeable and heritable genetic linkage differences. In the rare case where the alignment of homologous chromosomes is not exact, the crossing over or recombination event may result in an unequal exchange of information. One chromosome may receive less genetic material and thus a deletion, while the other partner of the chromosome pair receives more genetic material and thus an insertion or duplication (Figure 35–9). Unequal crossing over does occur in humans, as evidenced by the existence of hemoglobins designated Lepore and anti-Lepore (**Figure 35–10**). The farther apart any two genes are on an individual chromosome, the greater the likelihood of a crossover recombination event. This is the basis for genetic mapping methods. **Unequal crossover** affects tandem arrays of repeated DNAs whether they are related globin genes, as in Figure 35–10, or more abundant repetitive DNA. Unequal crossover through slippage in the pairing can result in expansion or contraction in the copy number of the repeat family and may contribute to the expansion and fixation of variant members throughout the repeat array.

Chromosomal Integration Occurs With Some Viruses

Some bacterial viruses (bacteriophages) are capable of recombining with the DNA of a bacterial host in such a way that the genetic information of the bacteriophage is incorporated in a linear fashion into the genetic information of the host. This integration, which is a form of recombination, occurs by the mechanism illustrated in **Figure 35–11**. The backbone of the circular bacteriophage genome is broken, as is that of the

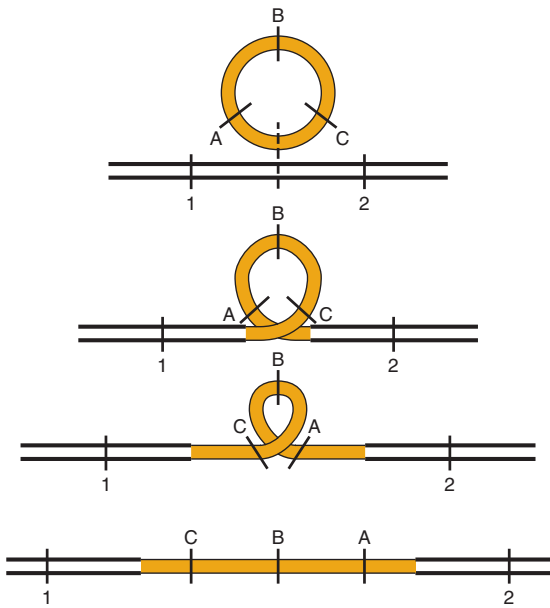

FIGURE 35-11 The integration of a circular genome from a virus (with genes A, B, and C) into the DNA molecule of a host (with genes 1 and 2) and the consequent ordering of the genes.

DNA molecule of the host; the appropriate ends are resealed with the proper polarity. The bacteriophage DNA is figuratively straightened out (“linearized”) as it is integrated into the bacterial DNA molecule—frequently a closed circle as well. The site at which the bacteriophage genome integrates or recombines with the bacterial genome is chosen by one of two mechanisms. If the bacteriophage contains a DNA sequence **homologous** to a sequence in the host DNA molecule, then a recombination event analogous to that occurring between homologous chromosomes can occur. However, some bacteriophages synthesize proteins that bind specific sites on bacterial chromosomes to a **nonhomologous** site characteristic of the bacteriophage DNA molecule. Integration occurs at the site and is said to be “**site specific**.”

Many animal viruses, particularly the oncogenic viruses—either directly or, in the case of RNA viruses such as HIV that causes AIDS, their DNA transcripts generated by the action of the viral **RNA-dependent DNA polymerase**, or **reverse transcriptase**—can be integrated into chromosomes of the mammalian cell. The integration of the animal virus DNA into the animal genome generally is not “site specific” but does display site preferences.

Transposition Can Produce Processed Genes

In eukaryotic cells, small DNA elements that clearly are not viruses are capable of transposing themselves in and out of the host genome in ways that affect the function of neighboring DNA sequences. These mobile elements, sometimes called “**jumping DNA**,” or jumping genes, can carry flanking regions of DNA and, therefore, profoundly affect evolution.

As mentioned above, the Alu family of moderately repeated DNA sequences has structural characteristics similar to the termini of retroviruses, which would account for the ability of the latter to move into and out of the mammalian genome.

Direct evidence for the transposition of other small DNA elements into the human genome has been provided by the discovery of “**processed genes**” for immunoglobulin molecules, α -globin molecules, and several others. These processed genes consist of DNA sequences identical or nearly identical to those of the messenger RNA for the appropriate gene product. That is, the 5′-nontranslated region, the coding region without intron representation, and the 3′ poly(A) tail are all present contiguously. This particular DNA sequence arrangement must have resulted from the reverse transcription of an appropriately processed messenger RNA molecule from which the intron regions had been removed and the poly(A) tail added. The only recognized mechanism this reverse transcript could have used to integrate into the genome would have been a transposition event. In fact, these “processed genes” have short terminal repeats at each end, as do known transposed sequences in lower organisms. In the absence of their transcription and thus genetic selection for function, many of the processed genes have been randomly altered through evolution so that they now contain nonsense codons that preclude their ability to encode a functional, intact protein (see Chapter 37) even if they could be transcribed. Thus, they are referred to as “**pseudogenes**.”

Gene Conversion Produces Rearrangements

Besides unequal crossover and transposition, a third mechanism can effect rapid changes in the genetic material. Similar sequences on homologous or nonhomologous chromosomes may occasionally pair up and eliminate any mismatched sequences between them. This may lead to the accidental fixation of one variant or another throughout a family of repeated sequences and thereby homogenize the sequences of the members of repetitive DNA families. This latter process is referred to as **gene conversion**.

Sister Chromatids Exchange

In diploid eukaryotic organisms such as humans, after cells progress through the S phase they contain a tetraploid content of DNA. This is in the form of sister chromatids of chromosome pairs (Figure 35-6). Each of these sister chromatids contains identical genetic information since each is a product of the semi-conservative replication of the original parent DNA molecule of that chromosome. Crossing over can occur between these genetically identical sister chromatids. Of course, these **sister chromatid exchanges** (Figure 35-12) have no genetic consequence as long as the exchange is the result of an equal crossover.

Immunoglobulin Genes Rearrange

In mammalian cells, some interesting gene rearrangements occur normally during development and differentiation. For example, the V_L and C_L genes, which encode for the



FIGURE 35-12 Sister chromatid exchanges between human chromosomes. The exchanges are detectable by Giemsa staining of the chromosomes of cells replicated for two cycles in the presence of bromodeoxyuridine. The arrows indicate some regions of exchange. (Courtesy of S Wolff and J Bodycote.)

immunoglobulin G (IgG) light chain variable (V_L) and constant (C_L) portions of the IgG light chain in a single IgG molecule (see Chapter 38), are widely separated in the germ line DNA. In the DNA of a differentiated IgG-producing (plasma) cell, the same V_L and C_L genes have been moved physically closer, and linked together in the genome within a single transcription unit. However, even then, this rearrangement of DNA during differentiation does not bring the V_L and C_L genes into contiguity in the DNA. Instead, the DNA contains an intron of about 1200 bp at or near the junction of the V and C regions. This intron sequence is transcribed into RNA along with the V_L and C_L exons, and the interspersed, intronic non-IgG sequence information is removed from the RNA during its nuclear processing (see Chapters 36 and 38).

DNA SYNTHESIS & REPLICATION ARE RIGIDLY CONTROLLED

The primary function of DNA replication is understood to be the provision of progeny with the genetic information possessed by the parent. Thus, the replication of DNA must be complete and carried out in such a way as to maintain genetic stability within the organism and the species. The process of DNA replication is complex and involves many cellular functions and several verification procedures to ensure fidelity in replication. About 30 proteins are involved in the replication of the *Escherichia coli* chromosome, and this process is

TABLE 35-4 Steps Involved in DNA Replication in Eukaryotes

1.	Identification of the origins of replication
2.	ATP hydrolysis-driven unwinding of dsDNA to provide an ssDNA template
3.	Formation of the replication fork; synthesis of RNA primer
4.	Initiation of DNA synthesis and elongation
5.	Formation of replication bubbles with ligation of the newly synthesized DNA segments
6.	Reconstitution of chromatin structure

more complex in eukaryotic organisms. The first enzymologic observations on DNA replication were made by Arthur Kornberg, who described in *E. coli* the existence of a replication enzyme now called DNA polymerase I. This enzyme has multiple catalytic activities, a complex structure, and a requirement for the triphosphates of the four deoxyribonucleosides of adenine, guanine, cytosine, and thymine. The polymerization reaction catalyzed by DNA polymerase I of *E. coli* has served as a prototype for all DNA polymerases of both prokaryotes and eukaryotes, even though it is now recognized that the major role of this polymerase is proofreading and repair.

In all cells, replication can occur only from a single-stranded DNA (ssDNA) template. Therefore, mechanisms must exist to target the site of initiation of replication and to unwind the dsDNA in that region. The replication complex must then form. After replication is complete in an area, the parent and daughter strands must re-form dsDNA. In eukaryotic cells, an additional step must occur. The dsDNA must re-form the chromatin structure, including nucleosomes that existed prior to the onset of replication. Although this entire process is not completely understood in eukaryotic cells, replication has been quite precisely described in prokaryotic cells, and the general principles are the same in both. The major steps are listed in Table 35-4, illustrated in Figure 35-13, and discussed, in sequence, below. A number of proteins, most with specific enzymatic action, are involved in this process (Table 35-5).

The Origin of Replication

At the **origin of replication (ori)**, there is an association of sequence-specific dsDNA-binding proteins with a series of direct repeat DNA sequences. In bacteriophage λ , the ori_{λ} is bound by the λ -encoded O protein to four adjacent sites. In *E. coli*, the $oriC$ is bound by the protein *dnaA*. In both cases, a complex is formed consisting of 150 to 250 bp of DNA and multimers of the DNA-binding protein. This leads to the local denaturation and unwinding of an adjacent A+T-rich region of DNA. Functionally similar **autonomously replicating sequences (ARS) or replicators** have been identified in yeast cells. The ARS contains a somewhat degenerate 11-bp sequence called the **origin replication element (ORE)**. The ORE binds a set of proteins, analogous to the *dnaA* protein

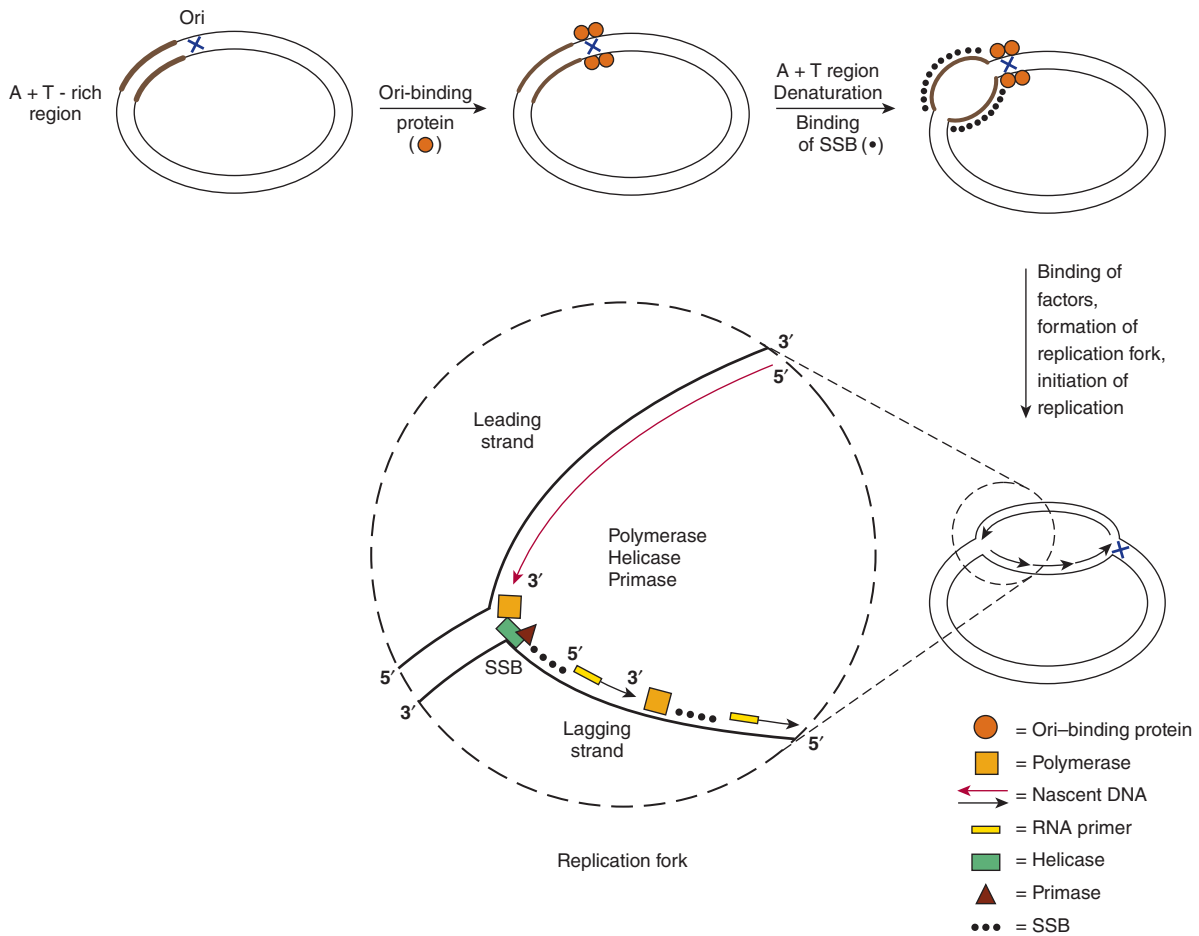

FIGURE 35-13 Steps involved in DNA replication. This figure describes DNA replication in an *E. coli* cell, but the general steps are similar in eukaryotes. A specific interaction of a protein (the *dnaA* protein) to the origin of replication (*oriC*) results in local unwinding of DNA at an adjacent A+T-rich region. The DNA in this area is maintained in the single-strand conformation (ssDNA) by single-strand-binding proteins (SSBs). This allows a variety of proteins, including helicase, primase, and DNA polymerase, to bind and to initiate DNA synthesis. The replication fork proceeds as DNA synthesis occurs continuously (long red arrow) on the leading strand and discontinuously (short black arrows) on the lagging strand. The nascent DNA is always synthesized in the 5' to 3' direction, as DNA polymerases can add a nucleotide only to the 3' end of a DNA strand.

of *E. coli*, the group of proteins is collectively called the **origin recognition complex (ORC)**. ORC homologs have been found in all eukaryotes examined. The ORE is located adjacent

to an approximately 80-bp A+T-rich sequence that is easy to unwind. This is called the **DNA unwinding element (DUE)**. The DUE is the origin of replication in yeast and is bound by the MCM protein complex.

Consensus sequences similar to *ori* or ARS in structure have not been precisely defined in mammalian cells, though several of the proteins that participate in *ori* recognition and function have been identified and appear quite similar to their yeast counterparts in both amino acid sequence and function.

TABLE 35-5 Classes of Proteins Involved in Replication

Protein	Function
DNA polymerases	Deoxynucleotide polymerization
Helicases	ATP-driven processive unwinding of DNA
Topoisomerases	Relieve torsional strain that results from helicase-induced unwinding
DNA primase	Initiates synthesis of RNA primers
Single-strand binding proteins (SSBs)	Prevent premature reannealing of dsDNA
DNA ligase	Seals the single strand nick between the nascent chain and Okazaki fragments on lagging strand

Unwinding of DNA

The interaction of proteins with *ori* defines the start site of replication and provides a short region of ssDNA essential for initiation of synthesis of the nascent DNA strand. This process requires the formation of a number of protein-protein and protein-DNA interactions. A critical step is provided by a DNA helicase that allows for processive unwinding of DNA. In uninfected *E. coli*, this function is provided by a complex

of dnaB helicase and the dnaC protein. Single-stranded DNA-binding proteins (SSBs) stabilize this complex. In λ phage-infected bacterial cells the phage protein P binds to dnaB and the P/dnaB complex binds to $ori\lambda$ by interacting with the O protein. dnaB is not an active helicase when in the P/dnaB/O complex. Three *E. coli* heat shock proteins (dnaK, dnaJ, and GrpE) cooperate to remove the P protein and activate the dnaB helicase. In cooperation with SSB, this leads to DNA unwinding and active replication. In this way, the replication of the λ phage is accomplished at the expense of replication of the host *E. coli* cell.

Formation of the Replication Fork

A replication fork consists of four components that form in the following sequence: (1) the DNA helicase unwinds a short segment of the parental duplex DNA; (2) a primase initiates synthesis of an RNA molecule that is essential for priming DNA synthesis; (3) the DNA polymerase initiates nascent, daughter-strand synthesis; and (4) SSBs bind to ssDNA and prevent premature reannealing of ssDNA to dsDNA. These reactions are illustrated in Figure 35–13.

The DNA polymerase III enzyme (the *dnaE* gene product in *E. coli*) binds to template DNA as part of a multiprotein complex that consists of several polymerase accessory factors (β , γ , δ , δ' , and τ). DNA polymerases only synthesize DNA in the 5' to 3' direction, and only one of the several different types of polymerases is involved at the replication fork. Because the DNA strands are antiparallel (see Chapter 34), the polymerase functions asymmetrically. On the **leading (forward) strand**, the DNA is synthesized continuously. On the **lagging (retro-grade) strand**, the DNA is synthesized in short (1–5 kb; see Figure 35–16) fragments, the so-called **Okazaki fragments**, so named after the scientist who discovered them. Several Okazaki fragments (up to a thousand) must be sequentially synthesized for each replication fork. To ensure that this happens, the helicase acts on the lagging strand to unwind dsDNA in a 5' to 3' direction. The helicase associates with the primase to afford the latter proper access to the template. This allows the RNA primer to be made and, in turn, the polymerase to begin replicating the DNA. This is an important reaction sequence since DNA polymerases cannot initiate DNA synthesis de novo. The mobile complex between helicase and primase has been called a **primosome**. As the synthesis of an Okazaki fragment is completed and the polymerase is released, a new primer has been synthesized. The same polymerase molecule remains associated with the replication fork and proceeds to synthesize the next Okazaki fragment.

The DNA Polymerase Complex

A number of different DNA polymerase molecules engage in DNA replication. These share three important properties: (1) **chain elongation**, (2) **processivity**, and (3) **proofreading**. Chain elongation accounts for the rate (in **nucleotides per second; nt/s**) at which polymerization occurs. Processivity is an expression of the number of nucleotides added to the nascent chain before the polymerase disengages from the

TABLE 35–6 A Comparison of Prokaryotic and Eukaryotic DNA Polymerases

<i>E. coli</i>	Eukaryotic	Function
I		Gap filling following DNA replication, repair, and recombination
II		DNA proofreading and repair
	β	DNA repair
	γ	Mitochondrial DNA synthesis
III	ϵ	Processive, leading strand synthesis
DnaG	α	Primase
	δ	Processive, lagging strand synthesis

template. The proofreading function identifies copying errors and corrects them. In *E. coli*, DNA polymerase III (pol III) functions at the replication fork. Of all polymerases, it catalyzes the highest rate of chain elongation and is the most processive. It is capable of polymerizing 0.5 Mb of DNA during one cycle on the leading strand. Pol III is a large (>1 MDa), multisubunit protein complex in *E. coli*. DNA pol III associates with the two identical β subunits of the DNA sliding “clamp”; this association dramatically increases pol III-DNA complex stability, processivity (100 to >50,000 nucleotides) and rate of chain elongation (20–50 nt/s) generating the high degree of processivity the enzyme exhibits.

Polymerase I (pol I) and II (pol II) are mostly involved in proofreading and DNA repair. Eukaryotic cells have counterparts for each of these enzymes plus a large number of additional DNA polymerases primarily involved in DNA repair. A comparison is shown in Table 35–6.

In mammalian cells, the polymerase is capable of polymerizing at a rate that is somewhat slower than the rate of polymerization of deoxynucleotides by the bacterial DNA polymerase complex. This reduced rate may result from interference by nucleosomes.

Initiation & Elongation of DNA Synthesis

The initiation of DNA synthesis (Figure 35–14) requires **priming by a short length of RNA**, about 10 to 200 nucleotides long. In *E. coli* this is catalyzed by dnaG (primase), in eukaryotes DNA Pol α synthesizes these RNA primers. The priming process involves nucleophilic attack by the 3'-hydroxyl group of the RNA primer on the phosphate of the first entering deoxynucleoside triphosphate (*N* in Figure 35–14) with the splitting off of pyrophosphate; this transition to DNA synthesis is catalyzed by the appropriate DNA polymerases (DNA pol III in *E. coli*; DNA pol δ and ϵ in eukaryotes). The 3'-hydroxyl group of the recently attached deoxyribonucleoside monophosphate is then free to carry out a **nucleophilic attack** on the next entering deoxyribonucleoside triphosphate (*N* + 1 in Figure 35–14), again at its α phosphate moiety, with the splitting off of pyrophosphate. Of course, selection of

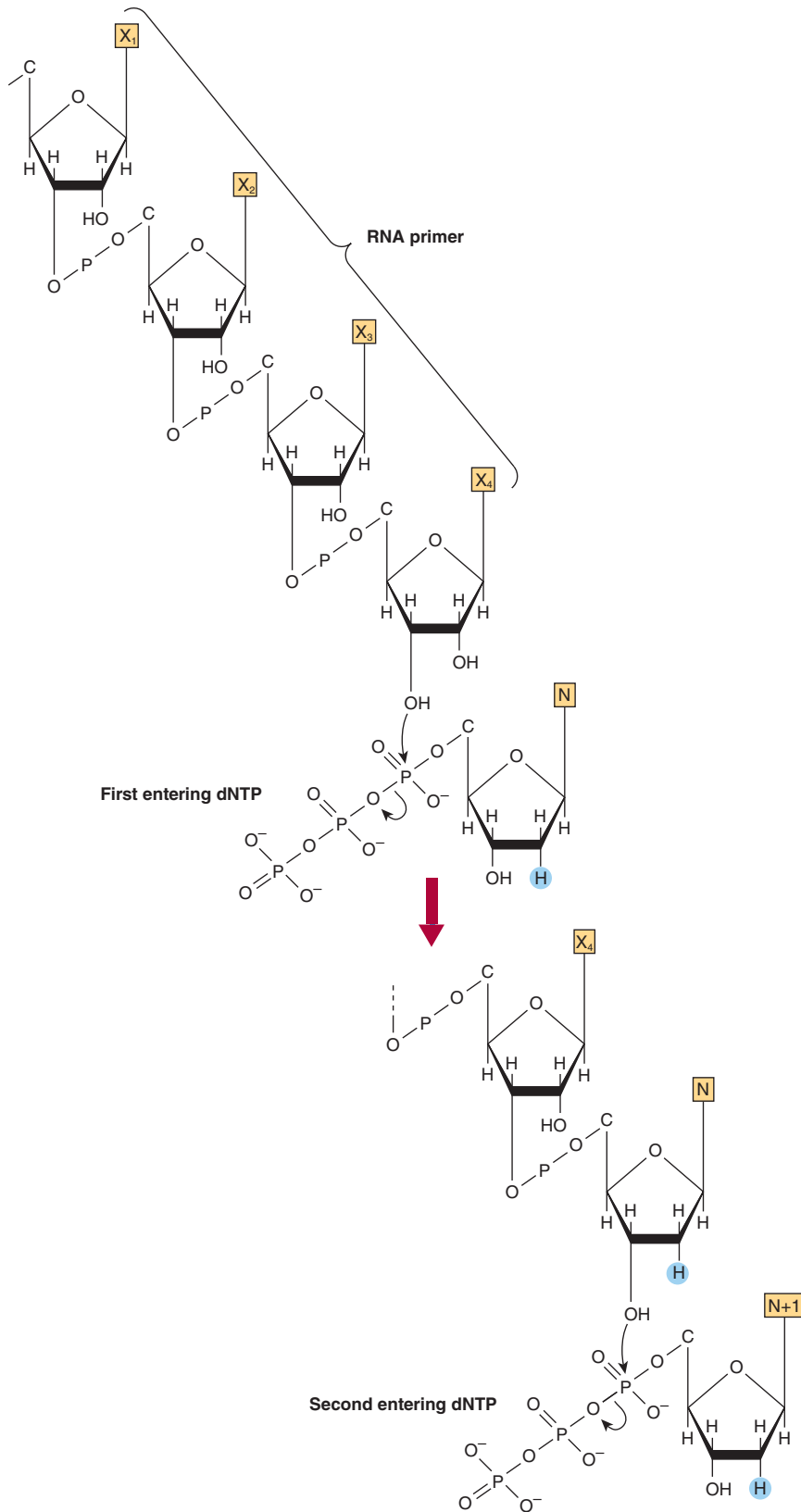

FIGURE 35-14 The initiation of DNA synthesis upon a primer of RNA and the subsequent attachment of the second deoxyribonucleoside triphosphate.

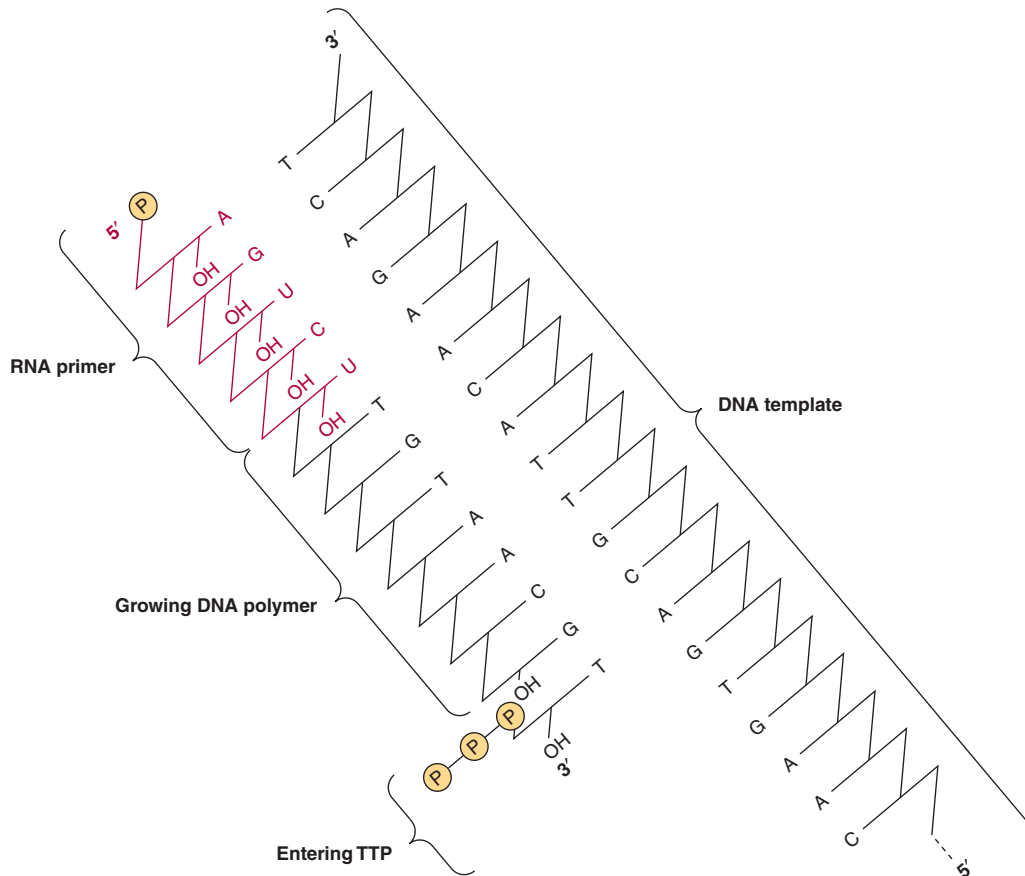

FIGURE 35-15 The RNA-primed synthesis of DNA demonstrating the template function of the complementary strand of parental DNA.

the proper deoxyribonucleotide whose terminal 3'-hydroxyl group is to be attacked is dependent upon **proper base pairing with the other strand** of the DNA molecule according to Watson and Crick base pairing rules (**Figure 35-15**). When an adenine deoxyribonucleoside monophosphoryl moiety is in the template position, a thymidine triphosphate will enter and its α phosphate will be attacked by the 3'-hydroxyl group of the deoxyribonucleoside monophosphoryl most recently added to the polymer. By this stepwise process, the template dictates which deoxyribonucleoside triphosphate is

complementary and by hydrogen bonding holds it in place while the 3'-hydroxyl group of the growing strand attacks and incorporates the new nucleotide into the polymer. These segments of DNA attached to an RNA initiator component are the **Okazaki fragments** (**Figure 35-16**). In mammals, after many Okazaki fragments are generated, the replication complex begins to remove the RNA primers, to fill in the gaps left by their removal with the proper base-paired deoxynucleotide, and then to seal the fragments of newly synthesized DNA by enzymes referred to as **DNA ligases**.

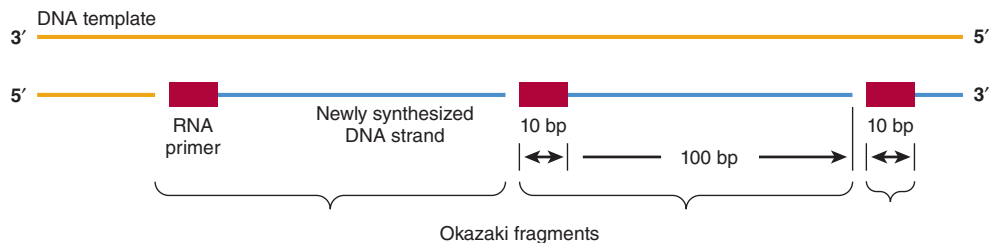

FIGURE 35-16 The discontinuous polymerization of deoxyribonucleotides on the lagging strand; formation of Okazaki fragments during lagging strand DNA synthesis is illustrated. Okazaki fragments are 100 to 250 nucleotides long in eukaryotes, 1000 to 2000 nucleotides in prokaryotes.

Replication Exhibits Polarity

As has already been noted, DNA molecules are double stranded and the two strands are antiparallel. The replication of DNA in prokaryotes and eukaryotes occurs on both strands simultaneously. However, an enzyme capable of polymerizing DNA in the 3' to 5' direction does not exist in any organism, so that both of the newly replicated DNA strands cannot grow in the same direction simultaneously. Nevertheless, in bacteria the same enzyme does replicate both strands at the same time (in eukaryotes Pol ϵ and Pol δ catalyze leading and lagging strand synthesis; see Table 35-6. The single enzyme replicates one strand ("leading strand") in a continuous manner in the 5' to 3' direction, with the same overall forward direction. It replicates the other strand ("lagging strand") discontinuously while polymerizing the nucleotides in short spurts of 150 to 250 nucleotides, again in the 5' to 3' direction, but at the same time it faces toward the back end of the preceding RNA primer rather than toward the unreplicated portion. This process of **semidiscontinuous DNA synthesis** is shown diagrammatically in Figures 35-13 and 35-16.

Formation of Replication Bubbles

Replication of the circular bacterial chromosome, composed of roughly 5×10^6 bp of DNA proceeds from a single ori. This process is completed in about 30 minutes, a replication rate of 3×10^5 bp/min. The entire mammalian genome replicates in approximately 9 hours, the average period required for formation of a tetraploid genome from a diploid genome in a replicating cell. If a mammalian genome (3×10^9 bp) replicated at the same rate as bacteria (ie, 3×10^5 bp/min) from but a single ori, replication would take over 150 hours! Metazoan organisms get around this problem using two strategies. First, replication is bidirectional. Second, replication proceeds from multiple origins in each chromosome (a total of as many as 100 in humans). Thus, replication occurs in both directions along all of the chromosomes, and both strands are replicated simultaneously. This replication process generates "**replication bubbles**" (Figure 35-17).

The multiple ori sites that serve as origins for DNA replication in eukaryotes are poorly defined except in a few animal

viruses and in yeast. However, it is clear that initiation is regulated both spatially and temporally, since clusters of adjacent sites initiate replication synchronously. Replication firing, or DNA replication initiation at a replicator/ori, is influenced by a number of distinct properties of chromatin structure that are just beginning to be understood. It is clear, however, that there are more replicators and excess ORC than needed to replicate the mammalian genome within the time of a typical S-phase. Therefore, mechanisms for controlling the excess ORC-bound replicators must exist. Understanding the control of the formation and firing of replication complexes is one of the major challenges in this field.

During the replication of DNA, there must be a separation of the two strands to allow each to serve as a template by hydrogen bonding its nucleotide bases to the incoming deoxynucleoside triphosphate. The separation of the DNA strands is promoted by **single strand DNA binding proteins (SSBs)** in *E coli*, and a protein termed **replication protein A (RPA)** in **eukaryotes**. These molecules stabilize the single-stranded structure as the replication fork progresses. The stabilizing proteins bind cooperatively and stoichiometrically to the single strands without interfering with the abilities of the nucleotides to serve as templates (Figure 35-13). In addition to separating the two strands of the double helix, there must be an unwinding of the molecule (once every 10 nucleotide pairs) to allow strand separation. The hexameric DNA β protein complex unwinds DNA in *E coli*, whereas the hexameric MCM complex unwinds eukaryotic DNA. This unwinding happens in segments adjacent to the replication bubble. To counteract this unwinding, there are multiple "swivels" interspersed in the DNA molecules of all organisms. The swivel function is provided by specific enzymes that introduce "**nicks**" in one strand of the unwinding double helix, thereby allowing the unwinding process to proceed. The nicks are quickly resealed without requiring energy input, because of the formation of a high-energy covalent bond between the nicked phosphodiester backbone and the nicking-sealing enzyme. The nicking-resealing enzymes are called **DNA topoisomerases**. This process is depicted diagrammatically in Figure 35-18 and there compared with the ATP-dependent resealing carried out by the DNA ligases. Topoisomerases

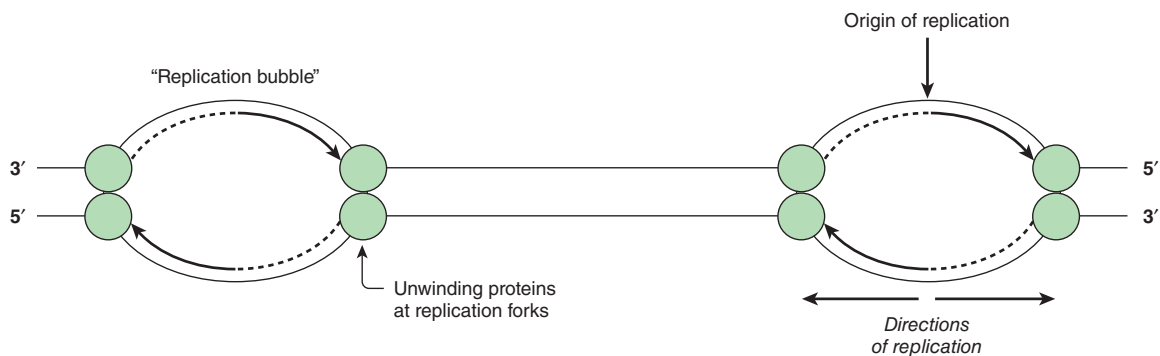
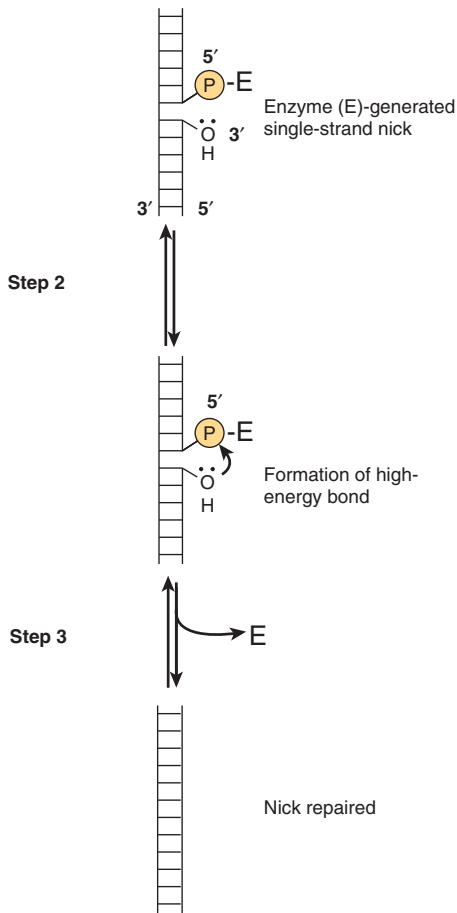

FIGURE 35-17 The generation of "replication bubbles" during the process of DNA synthesis. The bidirectional replication and the proposed positions of unwinding proteins at the replication forks are depicted.

Step 1 DNA topoisomerase I = E



DNA ligase = E

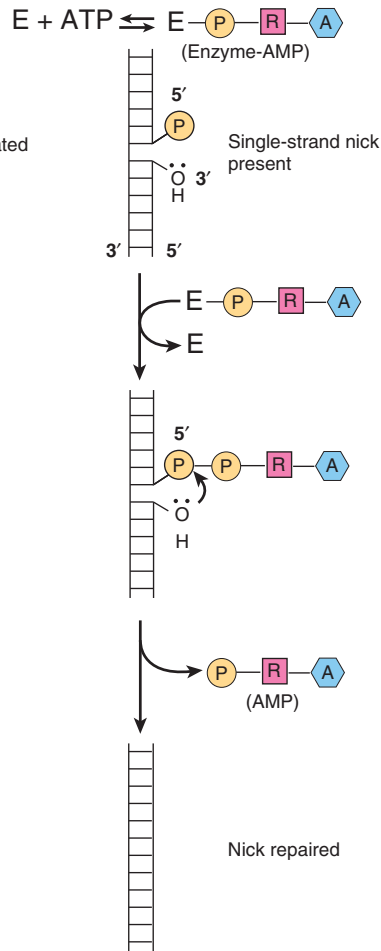

FIGURE 35-18 Comparison of two types of nick-sealing reactions on DNA. The series of reactions at left is catalyzed by DNA topoisomerase I, that at right by DNA ligase; P, phosphate; R, ribose; A, adenine. (Slightly modified and reproduced, with permission, from Lehninger AL: *Biochemistry*, 2nd ed. Worth, 1975. Copyright © 1975 by Worth Publishers. Used, with permission, from W. H. Freeman and Company.)

are also capable of unwinding supercoiled DNA. Supercoiled DNA is a higher-ordered structure occurring in circular DNA molecules wrapped around a core, as depicted in **Figures 35-2** and **35-19**.

There exists in one species of animal viruses (retroviruses) a class of enzymes capable of synthesizing a single-stranded and then a dsDNA molecule from a single-stranded RNA template. This polymerase, termed RNA-dependent DNA polymerase, or “**reverse transcriptase**,” first synthesizes a DNA-RNA hybrid molecule utilizing the RNA genome as a template. A specific virus-encoded nuclease, **RNase H**, degrades the hybridized template RNA strand, and the remaining DNA strand in turn serves as a template to form a dsDNA molecule containing the information originally present in the RNA genome of the animal virus.

Reconstitution of Chromatin Structure

There is evidence that nuclear organization and chromatin structure are involved in determining the regulation and initiation of DNA synthesis. As noted above, the rate of polymerization in eukaryotic cells, which have chromatin and nucleosomes, is slower than that in prokaryotic cells, which lack canonical nucleosomes. It is also clear that chromatin structure must be re-formed after replication. Newly replicated

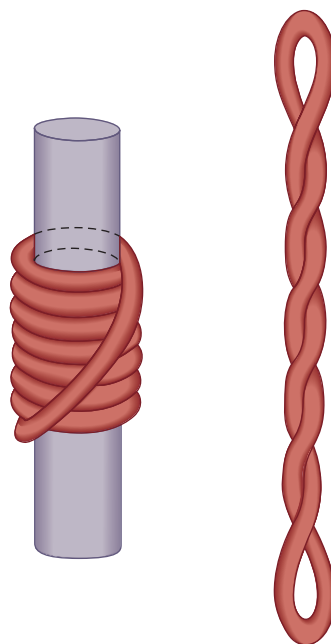

FIGURE 35-19 Supercoiling of DNA. A left-handed toroidal (solenoidal) supercoil, at left, will convert to a right-handed interwound supercoil, at right, when the cylindrical core is removed. Such a transition is analogous to that which occurs when nucleosomes are disrupted by the high salt extraction of histones from chromatin.

DNA is rapidly assembled into nucleosomes, and the preexisting and newly assembled histone octamers are randomly distributed to each arm of the replication fork. These reactions are facilitated through the actions of histone chaperone proteins working in concert with chromatin assembly and remodeling complexes.

DNA Synthesis Occurs During the S Phase of the Cell Cycle

In animal cells, including human cells, the replication of the DNA genome occurs only at a specified time during the life span of the cell. This period is referred to as the **synthetic or S phase**. This is usually temporally separated from the **mitotic, or M phase**, by nonsynthetic periods referred to as **gap 1 (G_1)** and **gap 2 (G_2)** phases, occurring before and after the S phase, respectively (Figure 35–20). Among other things, the cell prepares for DNA synthesis in G_1 , and for mitosis in G_2 . The cell regulates DNA synthesis by allowing it to occur only once per cell cycle, and only during S-phase, in cells preparing to divide by a mitotic process.

All eukaryotic cells have gene products that govern the transition from one phase of the cell cycle to another. The **cyclins** are a family of proteins whose concentration increases and decreases at specific times, that is, “cycle” during the cell cycle—thus their name. The cyclins thus activate, at the appropriate time, different **cyclin-dependent protein kinases**

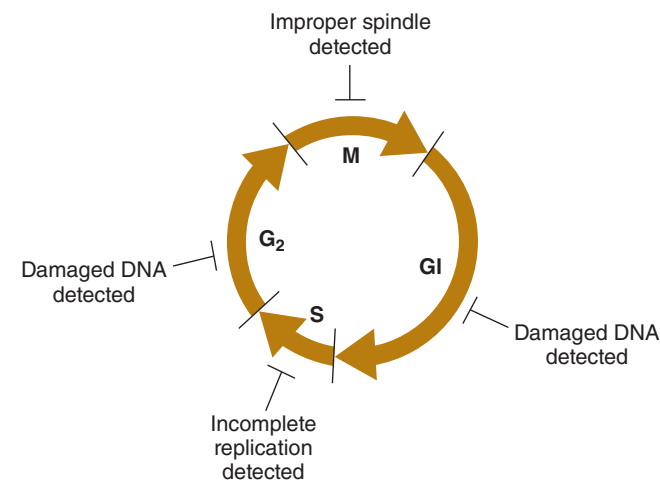

FIGURE 35–20 Progress through the mammalian cell cycle is continuously monitored via multiple cell-cycle checkpoints.

DNA, chromosome, and chromosome segregation integrity is continuously monitored throughout the cell cycle. If DNA damage is detected in either the G_1 or the G_2 phase of the cell cycle, if the genome is incompletely replicated, or if normal chromosome segregation machinery is incomplete (ie, a defective spindle), cells will not progress through the phase of the cycle in which defects are detected. In some cases, if the damage cannot be repaired, such cells undergo programmed cell death (apoptosis). Note that cells can reversibly leave the cell cycle during G_1 , entering a nonreplicative state termed G_0 (not shown, but see Figure 9–8). When appropriate signals/conditions occur cells re-enter G_1 and progress normally through the cell cycle as depicted.

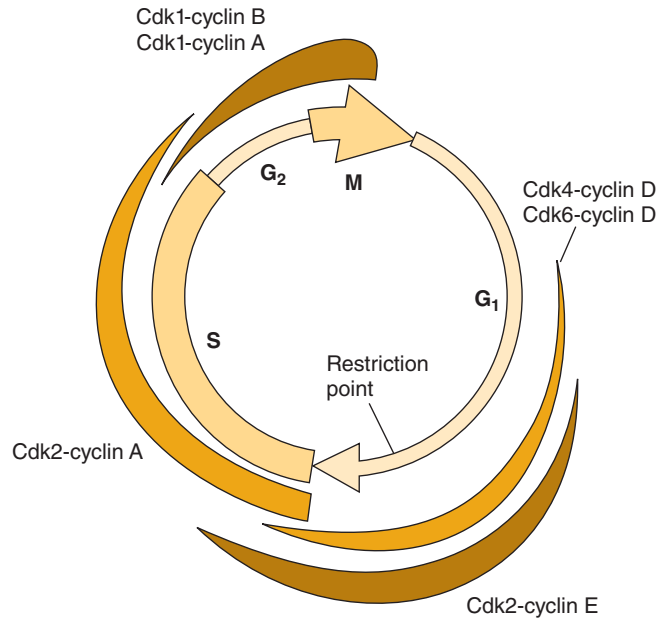

FIGURE 35–21 Schematic illustration of the points during the mammalian cell cycle during which the indicated cyclins and cyclin-dependent kinases are activated. The thickness of the various colored lines is indicative of the extent of activity.

(CDKs) that phosphorylate substrates essential for progression through the cell cycle (Figure 35–21). For example, cyclin D levels rise in late G_1 phase and allow progression beyond the **start (yeast) or restriction point (mammals)**, the point beyond which cells irrevocably proceed into the S or DNA synthesis phase.

The D cyclins activate CDK4 and CDK6. These two kinases are also synthesized during G_1 in cells undergoing active division. The D cyclins and CDK4 and CDK6 are nuclear proteins that assemble as a complex in late G_1 phase. The cyclin-CDK complex is now an active serine-threonine protein kinase. One substrate for this kinase is the retinoblastoma (Rb) protein. Rb is a cell-cycle regulator because it binds to and inactivates a transcription factor (E2F) necessary for the transcription of certain genes (histone genes, DNA replication proteins, etc) needed for progression from G_1 to S phase. The phosphorylation of Rb by CDK4 or CDK6 results in the release of E2F from Rb-mediated transcription repression—thus, gene transcription activation ensues and cell-cycle progression takes place.

Other cyclins and CDKs are involved in different aspects of cell-cycle progression (Table 35–7). Cyclin E and CDK2 form a

TABLE 35–7 Cyclins and Cyclin-Dependent Kinases Involved in Cell-Cycle Progression

Cyclin	Kinase	Function
D	CDK4, CDK6	Progression past restriction point at G_1/S boundary
E, A	CDK2	Initiation of DNA synthesis in early S phase
B	CDK1	Transition from G_2 to M

complex in late G_1 . Cyclin E is rapidly degraded, and the released CDK2 then forms a complex with cyclin A. This sequence is necessary for the initiation of DNA synthesis in S phase. A complex between cyclin B and CDK1 is rate-limiting for the G_2/M transition in eukaryotic cells.

Many of the cancer-causing viruses (oncoviruses) and cancer-inducing genes (oncogenes) are capable of alleviating or disrupting the apparent restriction that normally controls the entry of mammalian cells from G_1 into the S phase. From the foregoing, one might have surmised that excessive production of a cyclin, loss of a specific CDK inhibitor (see below), or production or activation of a cyclin/CDK at an inappropriate time might result in abnormal or unrestrained cell division. In this context, it is noteworthy that the *bcl* oncogene associated with B-cell lymphoma appears to be the cyclin D1 gene. Similarly, the oncoproteins (or transforming proteins) produced by several DNA viruses target the Rb transcription repressor for inactivation, inducing cell division inappropriately, while inactivation of Rb, itself a tumor suppressor gene, leads to uncontrolled cell growth and tumor formation.

During the S phase, mammalian cells contain greater quantities of DNA polymerase than during the nonsynthetic phases of the cell cycle. Furthermore, those enzymes responsible for formation of the substrates for DNA synthesis—that is, deoxyribonucleoside triphosphates—are also increased in activity, and their expression drops following the synthetic phase until the reappearance of the signal for renewed DNA synthesis. During the S phase, the **nuclear DNA is completely replicated once and only once**. Once chromatin has been replicated, it is marked so as to prevent its further replication until it again passes through mitosis. This process is termed replication licensing. The molecular mechanisms for this phenomenon in human cells involves dissociation and/or cyclin-CDK phosphorylation and subsequent degradation of several origin binding proteins that play critical roles in replication complex formation. Consequently origins fire only once per cell cycle.

In general, a given pair of chromosomes will replicate simultaneously and within a fixed portion of the S phase upon every replication. On a chromosome, clusters of replication units replicate coordinately. The nature of the signals that regulate DNA synthesis at these levels is unknown, but the regulation does appear to be an intrinsic property of each individual chromosome that is mediated by the several replication origins contained therein.

All Organisms Contain Elaborate Evolutionarily Conserved Mechanisms to Repair Damaged DNA

Repair of damaged DNA is critical for maintaining genomic integrity and thereby preventing the propagation of mutations, either horizontally, that is DNA sequence changes in somatic cells, or vertically, where nonrepaired lesions are present in sperm or oocyte DNA and hence can be transmitted to progeny. DNA is subjected to a huge array of chemical,

TABLE 35-8 Types of Damage to DNA

I. Single-base alteration
A. Depurination
B. Deamination of cytosine to uracil
C. Deamination of adenine to hypoxanthine
D. Alkylation of base
F. Base-analog incorporation
II. Two-base alteration
A. UV light-induced thymine-thymine (pyrimidine) dimer
B. Bifunctional alkylating agent cross-linkage
III. Chain breaks
A. Ionizing radiation
B. Radioactive disintegration of backbone element
C. Oxidative free radical formation
IV. Cross-linkage
A. Between bases in same or opposite strands
B. Between DNA and protein molecules (eg, histones)

physical, and biological assaults on a daily basis (**Table 35-8**), hence efficient recognition and repair of DNA lesions is essential. Consequently, eukaryotic cells contain five major DNA repair pathways, each of which contain multiple, sometimes shared proteins; these DNA repair proteins typically have orthologues in prokaryotes. The mechanisms of DNA repair include **nucleotide excision repair (NER)**; **mismatch repair (MMR)**; **base excision repair (BER)**; **homologous recombination (HR)**; and **nonhomologous end-joining (NHEJ)** repair pathways (**Figure 35-22**). The experiment of testing the importance of many of these DNA repair proteins to human biology has been performed by nature—mutations in a large number of these genes lead to human disease (**Table 35-9**). Moreover, systematic gene-directed “knock-out” experiments (see Chapter 39) with laboratory mice have clearly ascribed critical gene integrity maintenance functions to these genes as well. In the mouse genetic studies, it was observed that indeed targeted mutations within these genes induce defects in DNA repair while often also dramatically increasing susceptibility to cancer.

One of the most intensively studied mechanisms of DNA repair is the mechanism used to repair DNA **double-strand breaks (DSBs)**; these will be discussed in some detail here. There are two pathways, **HR** and **NHEJ**, that eukaryotic cells utilize to remove DSBs. The choice between the two depends upon the phase of the cell cycle (Figures 35-20 and 35-21) and the exact type of DSB breaks to be repaired (Table 35-8). During the G_0/G_1 phases of the cell cycle, DSBs are corrected by the NHEJ pathway, whereas during S, G_2 , and M phases of the cell cycle HR is utilized. All steps of DNA damage repair are catalyzed by evolutionarily conserved molecules, which include **DNA damage Sensors**, **Transducers**, and **damage repair Mediators**. Collectively, these cascades of proteins participate in the cellular response to DNA damage. Importantly, the ultimate cellular outcomes of DNA damage and cellular attempts to repair DNA damage range from

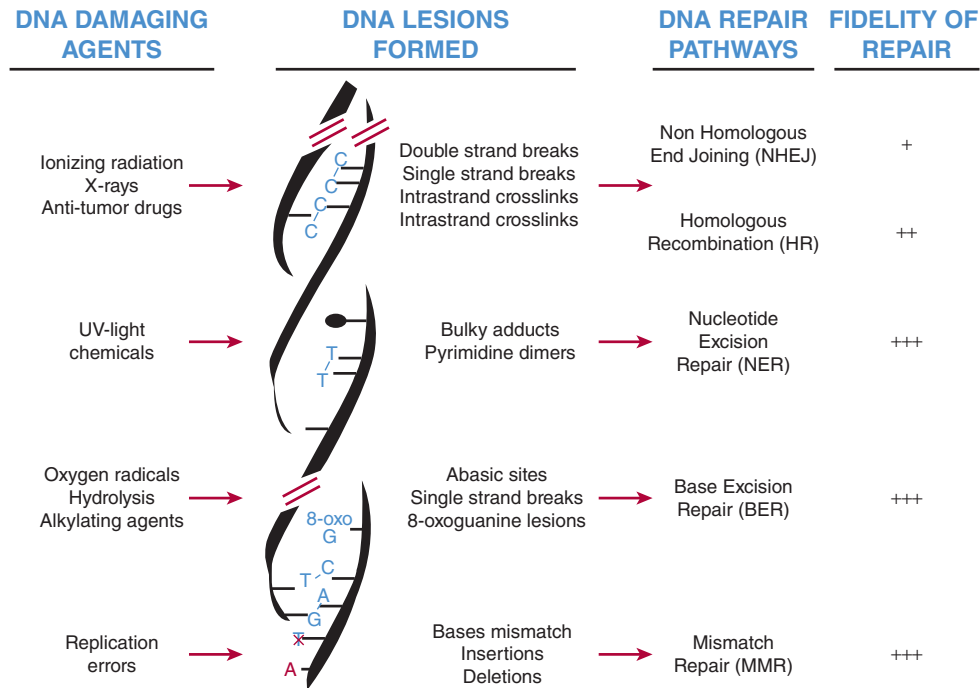

FIGURE 35–22 Mammals use multiple DNA repair pathways of variable accuracy to repair the myriad forms of DNA damage genomic DNA is subjected to. Listed are the major types of DNA damaging agents, the DNA lesions so formed (schematized and listed), the DNA repair pathway responsible for repairing the different lesions, and the relative fidelity of these pathways. (Modified, with permission, from: “DNA-Damage Response in Tissue-Specific and Cancer Stem Cells” *Cell Stem Cell* 8:16–29 (2011) copyright © 2011 Elsevier Inc.

TABLE 35–9 Human Diseases of DNA Damage Repair

Defective Nonhomologous End Joining Repair (NHEJ) Severe combined immunodeficiency disease (SCID) Radiation sensitive severe combined immunodeficiency disease (RS-SCID)
Defective Homologous Repair (HR) AT-like disorder (ATLD) Nijmegen breakage syndrome (NBS) Bloom syndrome (BS) Werner syndrome (WS) Rothmund-Thomson syndrome (RTS) Breast cancer susceptibility 1 and 2 (BRCA1, BRCA2)
Defective DNA Nucleotide Excision Repair (NER) Xeroderma pigmentosum (XP) Cockayne syndrome (CS) Trichothiodystrophy (TTD)
Defective DNA Base Excision Repair (BER) MUTYH-associated polyposis (MAP)
Defective DNA Mismatch Repair (MMR) Hereditary nonpolyposis colorectal cancer (HNPCC)

cell-cycle delay to allow for DNA repair, to cell-cycle arrest, to apoptosis or senescence (see Figure 35–23; and further detail below). The molecules involved in these complex and highly integrated processes range from damage-specific histone modifications (ie, dimethylated lysine 20 histone H4; H4K20me2) and incorporation of histone isotype variants

such as histone H2AX into nucleosomes at the site of DNA damage (cf Table 35–1), poly ADP ribose polymerase, PARP, the MRN protein complex (Mre11-Rad50-NBS1 subunits); to DNA damage-activated kinase recognition/signaling proteins (ATM [ataxia telangiectasia, mutated] and ATM-related kinase, ATR, the multisubunit DNA-dependent protein kinase [DNA-PK and Ku70/80], and checkpoint kinases 1 and 2 [CHK1, CHK2]). These multiple kinases phosphorylate, and consequently modulate the activities of dozens of proteins, such as numerous DNA repair, checkpoint control, and cell-cycle control proteins like CDC25A, B, C, Wee1, p21, p16, and p19 (all Cyclin-CDK regulators [see Figure 9–8; and below]; various exo- and endonucleases; DNA single-strand-specific DNA-binding proteins [RPA]; PCNA and specific DNA polymerases [DNA pol delta, δ ; and eta, η]). Several of these (types) of proteins/enzymes have been discussed above in the context of DNA replication. DNA repair and its relationship to cell cycle control are very active areas of research given their central roles in cell biology and potential for generating and preventing cancer.

DNA & Chromosome Integrity Is Monitored Throughout the Cell Cycle

Given the importance of normal DNA and chromosome function to survival, it is not surprising that eukaryotic cells have developed elaborate mechanisms to monitor the integrity of

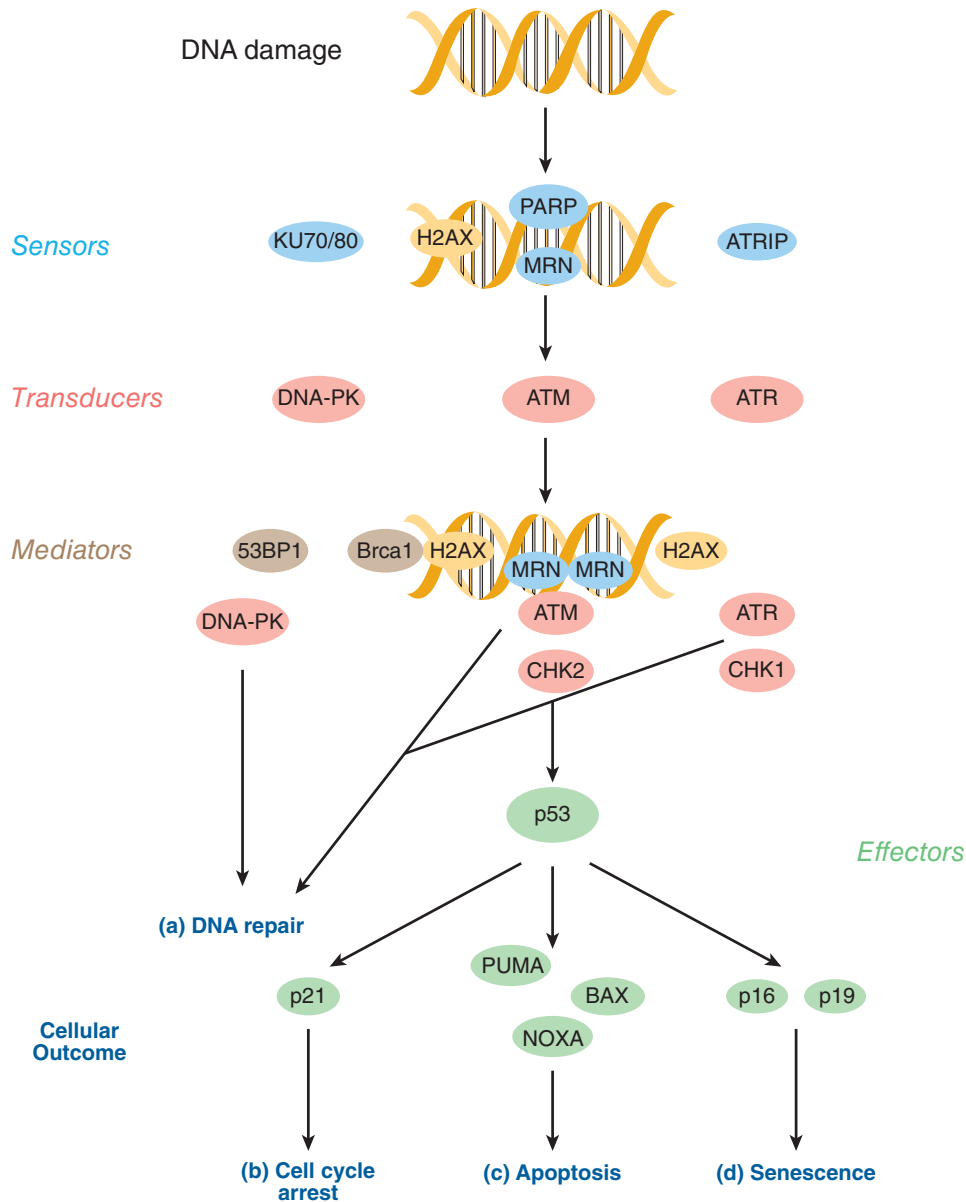

FIGURE 35–23 The multistep mechanism of DNA double-strand break repair. Shown top to bottom are the proteins (protein complexes) that: identify DSBs in genomic DNA (sensors), transduce and amplify the recognized DNA damage (transducers and mediators), as well as the molecules that dictate the ultimate outcomes of the DNA damage response (effectors). Damaged DNA can be: (a) repaired directly (DNA repair), or via p53-mediated pathways and depending upon the severity of DNA damage and p53-activated genes induced, (b), cells can be arrested in the cell cycle by p21/WAF1 the potent CDK–cyclin complex inhibitor to allow time for extensively damaged DNA to be repaired, or (c), and (d) if the extent of DNA damage is too great to repair, cells can either apoptose or senesce; both of these processes prevent the cell containing such damaged DNA from ever dividing and hence inducing cancer or other deleterious biological outcomes. (Based on: “DNA-Damage Response in Tissue-Specific and Cancer Stem Cells” *Cell Stem Cell* 8:16–29 (2011) copyright © 2011 Elsevier Inc.)

the genetic material. As detailed above, a number of complex multisubunit enzyme systems have evolved to repair damaged DNA at the nucleotide sequence level. Similarly, DNA mishaps at the chromosome level are also monitored and repaired. As shown in Figure 35–20, both DNA and chromosomal integrity are continuously monitored throughout the cell cycle. The four specific steps at which this monitoring occurs have been

termed **checkpoint controls**. If problems are detected at any of these checkpoints, progression through the cycle is interrupted and transit through the cell cycle is halted until the damage is repaired. The molecular mechanisms underlying detection of DNA damage during the G_1 and G_2 phases of the cycle are understood better than those operative during S and M phases.

The **tumor suppressor p53**, a protein of apparent MW 53 kDa on SDS-PAGE, plays a key role in both G₁ and G₂ checkpoint control. Normally a very unstable protein, p53 is a DNA-binding transcription factor, **one of a family of related proteins** (ie, **p53**, **p63**, and **p73**) that is somehow stabilized in response to DNA damage, perhaps by direct p53-DNA interactions. Like the histones discussed above, p53 is subject to a panoply of regulatory PTMs, all of which likely modify its multiple biological activities. Increased levels of p53 activate transcription of an ensemble of genes that collectively serve to delay transit through the cycle. One of these induced proteins, **p21**, is a **potent CDK-cyclin inhibitor (CKI)** that is capable of efficiently inhibiting the action of all CDKs. Clearly, inhibition of CDKs will halt progression through the cell cycle (see Figures 35–19 and 35–20). If DNA damage is too extensive to repair, the affected cells undergo **apoptosis** (programmed cell death) in a p53-dependent fashion. In this case, p53 induces the activation of a collection of genes that induce apoptosis. Cells lacking functional p53 fail to undergo apoptosis in response to high levels of radiation or DNA-active chemotherapeutic agents. It may come as no surprise, then, that *p53* is one of the most frequently mutated genes in human cancers (Chapter 56). Indeed recent genomic sequencing studies of multiple tumor DNA samples suggest that over 80% of human cancers carry p53 loss of function mutations. Additional research into the mechanisms of checkpoint control will prove invaluable for the development of effective anticancer therapeutic options.

SUMMARY

- DNA in eukaryotic cells is associated with a variety of proteins, resulting in a structure called chromatin.
- Much of the DNA is associated with histone proteins to form a structure called the nucleosome. Nucleosomes are composed of an octamer of histones around which about 150 bp of DNA is wrapped.
- Histones are subject to an extensive array of dynamic covalent modifications that have important regulatory consequences.
- Nucleosomes and higher-order structures formed from them serve to compact the DNA.
- DNA in transcriptionally active regions is relatively more sensitive to nuclease attack *in vitro*; some regions, so-called hypersensitive sites are exceptionally sensitive and are often found to contain transcription control sites.
- Highly transcriptionally active DNA (genes) is often clustered in regions of each chromosome. Within these regions, genes may be separated by inactive DNA in nucleosomal structures. In many eukaryotic transcription units (ie, the portion of a gene that is copied by RNA polymerase) often consists of coding regions of DNA (exons) interrupted by intervening sequences of noncoding DNA (introns). This is particularly true for mRNA-encoding genes.
- After transcription, during RNA processing, introns are removed and the exons are ligated together to form the mature mRNA that appears in the cytoplasm; this process is termed RNA splicing.
- DNA in each chromosome is exactly replicated according to the rules of base pairing during the S phase of the cell cycle.
- Each strand of the double helix is replicated simultaneously but by somewhat different mechanisms. A complex of proteins, including DNA polymerase, replicates the leading strand continuously in the 5′ to 3′ direction. The lagging strand is replicated discontinuously, in short pieces of 100 to 250 nucleotides by DNA polymerase synthesizing in the 5′ → 3′ direction.
- DNA replication is initiated at special sites termed origins, or ori’s, to generate replication bubbles. Each eukaryotic chromosome contains multiple origins. The entire process takes about 9 h in a typical human cell and only occurs during the S phase of the cell cycle.
- A variety of mechanisms that employ different enzyme systems repair damaged cellular DNA after exposure of cells to chemical and physical mutagens.
- Normal cells containing DNA that cannot be repaired undergo programmed cell death.

REFERENCES

- Blanpain C, Mohrin M, Sotiropoulou PA, et al: DNA-damage response in tissue-specific and cancer stem cells. *Cell Stem Cell* 2011;8:16–29.
- Bohgaki T, Bohgaki M, Hakem R: DNA double-strand break signaling and human disorders. *Genome Integr* 2010;1:15–29.
- Campbell RM, Tummino PJ: Cancer epigenetics drug discovery and development: the challenge of hitting the mark. *J Clin Invest*. 2014;124:64–69.
- Campos EL, Reinberg D: Histones: annotating chromatin. *Annu Rev Genet* 2009;43:559–599.
- Collas C, Lund EG, Oldenburg AR: Closing the (nuclear) envelope on the genome: how nuclear lamins interact with promoters and modulate gene expression. *Bioessays* 2013;6:75–83.
- David CJ, Manley JL: Alternative pre-mRNA splicing regulation in cancer: pathways and programs unhinged. *Genes Dev* 2010;24:2343–2364.
- Doolittle WF, Fraser P, Gerstein MB, et al. Sixty years of genome biology 2013;14:113. PMID: PMC3663092.
- Gerstein M: Genomics: ENCODE leads the way on big data. *Nature* 2012;489:208.
- Hanahan D, Weinberg RA: Hallmarks of cancer: the next generation. *Cell* 2011;144:646–674.
- Krishnan KJ, Reeve AK, Samuels DC, et al: What causes mitochondrial DNA deletions in human cells? *Nat Genet* 2008;40:275–279.
- Kurth I, O’Donnell M: New insights into replisome fluidity during chromosome replication. *Trends Biochem Sci* 2013;38:195–203.
- Lander ES, Linton LM, Birren B, et al: Initial sequencing and analysis of the human genome. *Nature* 2001;409:860.
- Luger K, Mäder AW, Richmond RK, et al: Crystal structure of the nucleosome core particle at 2.8 Å resolution. *Nature* 1997;389:251–260.
- Margueron R, Reinberg D: Chromatin structure and the inheritance of epigenetic information. *Nat Rev Genet* 2010;11:285–296.
- Misteli T: The cell biology of genomes: bringing the double helix to life. *Cell* 2013;152:1209–1212.
- Navarro FJ, Weston L, Nurse P: Global control of cell growth in fission yeast and its coordination with the cell cycle. *Curr Opin Cell Biol* 2012;24:833–837.

- Nelson DL, Orr HT, Warren ST: The unstable repeats—three evolving faces of neurological disease. *Neuron* 2013;77:825–843.
- O'Donnell M, Langston L, Stillman B: Principles and concepts of DNA replication in bacteria, archaea, and eukarya. *Cold Spring Harb Perspect Biol* 2013 Jul 1;5:a010108.
- Ponicsan SL, Kugel JF, Goodrich JA: Genomic gems: SINE RNAs regulate mRNA production. *Curr Opin Genet Develop* 2010;20:149–155.
- Pope BD, Gilbert DM: The replication domain model: regulating replicon firing in the context of large-scale chromosome architecture. *J Mol Biol* 2013;425:4690–4695.
- Pouladi MA, Morton AJ, Hayden MR: Choosing an animal model for the study of Huntington's disease. *Nat Rev Neurosci* 2013;14:708–721.
- Skene PJ, Henikoff S: Histone variants in pluripotency and disease. *Development* 2013;140:2513–2524.
- Tanaka TU, Clayton L, Natsume T: Three wise centromere functions: see no error, hear no break, speak no delay. *EMBO Rep* 2013;14:1073–1083.
- Venter JC, Adams MD, Myers EW, et al: The sequence of the human genome. *Science* 2002;291:1304–1351.
- Voigt P, Tee WW, Reinberg D: A double take on bivalent promoters. *Genes Dev* 2013;27:1318–1338.
- Zaidi SK, Young DW, Montecino M, et al: Bookmarking the genome: maintenance of epigenetic information. *J Biol Chem* 2011;286:18355–183561.

RNA Synthesis, Processing, & Modification

P. Anthony Weil, PhD

OBJECTIVES

After studying this chapter, you should be able to:

- Describe the molecules involved and the mechanism of RNA synthesis.
- Explain how eukaryotic DNA-dependent RNA polymerases, in collaboration with an array of specific accessory factors, can differentially transcribe genomic DNA to produce specific mRNA precursor molecules.
- Describe the structure of eukaryotic mRNA precursors, which are highly modified internally and at both termini.
- Appreciate the fact that the majority of mammalian mRNA-encoding genes are interrupted by multiple non-protein coding sequences termed introns, which are interspersed between protein coding regions termed exons.
- Explain that since intron RNA does not encode protein, the intronic RNA must be specifically and accurately removed in order to generate functional mRNAs from the mRNA precursor molecules in a series of precise molecular events termed RNA splicing.
- Explain the steps and molecules that catalyze mRNA splicing, a process that converts the end-modified precursor molecules into mRNAs that are functional for translation.

BIOMEDICAL IMPORTANCE

The synthesis of an RNA molecule from DNA is a complex process involving one of the group of DNA-dependent RNA polymerase enzymes and a number of associated proteins. The general steps required to synthesize the primary transcript are initiation, elongation, and termination. Most is known about initiation. A number of DNA regions (generally located upstream from the initiation site) and protein factors that bind to these sequences to regulate the initiation of transcription have been identified. Certain RNAs—mRNAs in particular—have very different life spans in a cell. The RNA molecules synthesized in mammalian cells are made as precursor molecules that have to be processed into mature, active RNA. It is important to understand the basic principles of messenger RNA (mRNA) synthesis and metabolism, for modulation of this process results in altered rates of protein synthesis and thus a variety of both metabolic and phenotypic changes. This is how all organisms adapt to changes of environment. It is also how differentiated cell structures and functions are established and maintained. Errors or changes in synthesis,

processing, splicing, stability, or function of mRNA transcripts are a cause of disease.

RNA EXISTS IN TWO MAJOR CLASSES

All eukaryotic cells have two major classes of RNA (**Table 36–1**), the **protein coding RNAs**, or messenger RNAs (**mRNAs**), and two forms of abundant **non-protein coding RNAs** delineated on the basis of size: the large ribosomal RNAs (**rRNA**) and long noncoding RNAs (**lncRNAs**) and small noncoding RNAs transfer RNAs (**tRNA**), the small nuclear RNAs (**snRNAs**) and the micro and silencing RNAs (**miRNAs** and **siRNAs**). The mRNAs, rRNAs and tRNAs are directly involved in protein synthesis while the other RNAs are participate in either mRNA splicing (snRNAs) or modulation of gene expression by altering mRNA function (mi/SiRNAs) and/or expression (lncRNAs). These RNA differ in their diversity, stability, and abundance in cells.

TABLE 36-1 Classes of Eukaryotic RNA

RNA	Types	Abundance	Stability
<i>Protein Coding RNAs</i>			
Messenger (mRNA)	≥10 ⁵ Different species	2%-5% of total	Unstable to very stable
<i>Nonprotein Coding RNAs (ncRNAs)</i>			
Large ncRNAs			
Ribosomal (rRNA)	28S, 18S, 5.8S, 5S	80% of total	Very stable
lncRNAs	~1000s	~1%-2%	Unstable to very stable
Small ncRNAs			
Transfer RNAs	~60 Different species	~15% of total	Very stable
Small nuclear (snRNA)	~30 Different species	≤1% of total	Very stable
Micro/Silencing (mi/SiRNAs)	100s-1000	<1% of total	Stable

RNA IS SYNTHESIZED FROM A DNA TEMPLATE BY AN RNA POLYMERASE

The processes of DNA and RNA synthesis are similar in that they involve (1) the general steps of initiation, elongation, and termination with 5′–3′ polarity; (2) large, multicomponent initiation complexes; and (3) adherence to Watson–Crick base-pairing rules. However, DNA and RNA synthesis do differ in several important ways, including the following: (1) ribonucleotides are used in RNA synthesis rather than deoxyribonucleotides; (2) U replaces T as the complementary base for A in RNA; (3) a primer is not involved in RNA synthesis as RNA polymerases have the ability to initiate synthesis *de novo*; (4) in a given cell only portions of the genome are vigorously transcribed or copied into RNA, whereas the entire genome must be copied, once and only once during DNA replication; and (5) there is no highly active, efficient proofreading function during RNA transcription.

The process of synthesizing RNA from a DNA template has been characterized best in prokaryotes. Although in mammalian cells, the regulation of RNA synthesis and the processing of the RNA transcripts are different from those in prokaryotes, the process of RNA synthesis *per se* is quite similar in these two classes of organisms. Therefore, the description of RNA synthesis in prokaryotes, where it is best understood, is applicable to eukaryotes even though the enzymes involved and the regulatory signals, though related, are different.

The Template Strand of DNA Is Transcribed

The sequence of ribonucleotides in an RNA molecule is complementary to the sequence of deoxyribonucleotides in one strand of the double-stranded DNA molecule (see Figure 34–8).

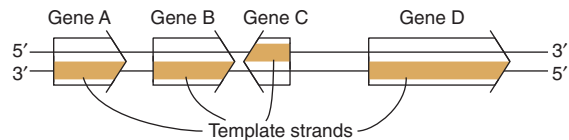

FIGURE 36-1 Genes can be transcribed off both strands of DNA. The arrowheads indicate the direction of transcription (polarity). Note that the template strand is always read in the 3′–5′ direction. The opposite strand is called the coding strand because it is identical (except for T for U changes) to the mRNA transcript (the primary transcript in eukaryotic cells) that encodes the protein product of the gene.

The strand that is transcribed or copied into an RNA molecule is referred to as the **template strand** of the DNA. The other DNA strand, the **non template strand**, is frequently referred to as the **coding strand** of that gene. It is called this because, with the exception of T for U changes, it corresponds exactly to the sequence of the messenger RNA primary transcript, which encodes the (protein) product of the gene. In the case of a double-stranded DNA molecule containing many genes, the template strand for each gene will not necessarily be the same strand of the DNA double helix (Figure 36–1). Thus, a given strand of a double-stranded DNA molecule will serve as the template strand for some genes and the coding strand of other genes. Note that the nucleotide sequence of an RNA transcript will be the same (except for U replacing T) as that of the coding strand. The information in the template strand is read out in the 3′–5′ direction. Though not shown in Figure 36–1 there are instances of genes embedded within other genes.

DNA-Dependent RNA Polymerase Binds to a Distinct Site, the Promoter, and Initiates Transcription

DNA-dependent RNA polymerase is the enzyme responsible for the polymerization of ribonucleotides into a sequence complementary to the template strand of the gene (see Figures 36–2

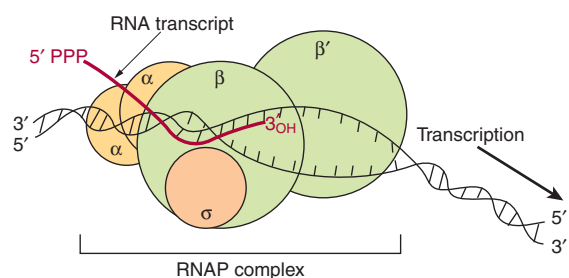

FIGURE 36-2 RNA polymerase catalyzes the polymerization of ribonucleotides into an RNA sequence that is complementary to the template strand of the gene. The RNA transcript has the same polarity (5′–3′) as the coding strand but contains U rather than T. Bacterial RNAP consists of a core complex of two β subunits (β and β′) and two α subunits. The holoenzyme contains the σ subunit bound to the α₂ββ′ core assembly. The σ subunit is not shown. The transcription “bubble” is an approximately 20-bp area of melted DNA, and the entire complex covers 30–75 bp of DNA depending on the conformation of RNAP.

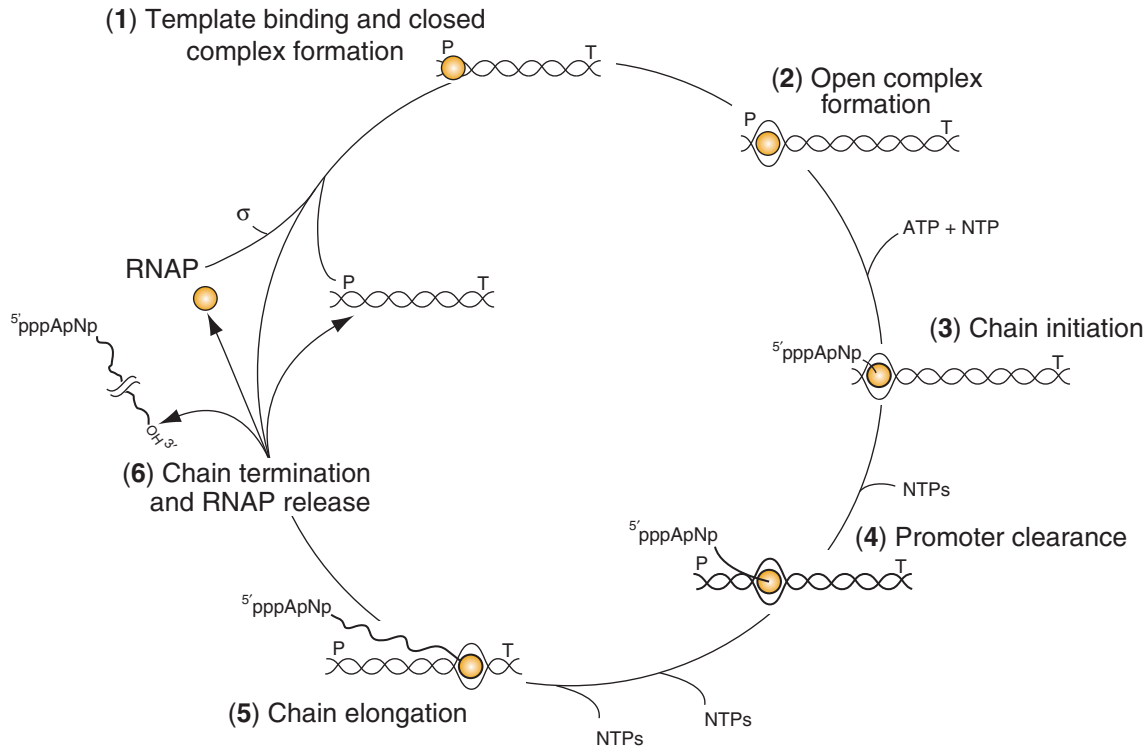

FIGURE 36-3 The transcription cycle. The transcription cycle can be described in six steps: **(1) Template binding and closed RNA polymerase-promoter complex formation:** RNAP binds to DNA and then locates a promoter (P), **(2) Open promoter complex formation:** once bound to the promoter, RNAP melts the two DNA strands to form an open promoter complex; this complex is also referred to as the pre-initiation complex or PIC. Strand separation allows the polymerase to access the coding information in the template strand of DNA **(3) Chain initiation:** using the coding information of the template RNAP catalyzes the coupling of the first base (often a purine) to the second, template-directed ribonucleoside triphosphate to form a dinucleotide (in this example forming the dinucleotide 5' pppApN_{OH 3'}). **(4) Promoter clearance:** after RNA chain length reaches ~10–20 nt, the polymerase undergoes a conformational change and then is able to move away from the promoter, transcribing down the transcription unit. **(5) Chain elongation:** Successive residues are added to the 3'-OH terminus of the nascent RNA molecule until a transcription termination signal (T) is encountered. **(6) Chain termination and RNAP release:** Upon encountering the transcription termination site RNAP undergoes an additional conformational change that leads to release of the completed RNA chain, the DNA template and RNAP. RNAP can rebind to DNA beginning the promoter search process and the cycle is repeated. Note that all of the steps in the transcription cycle are facilitated by additional proteins, and indeed are often subjected to regulation by positive and/or negative-acting factors.

and 36-3). The enzyme attaches at a specific site—the promoter—on the template strand. This is followed by initiation of RNA synthesis at the starting point, and the process continues until a termination sequence is reached (Figure 36-3). A **transcription unit** is defined as that region of DNA that includes the signals for transcription initiation, elongation, and termination. The RNA product, which is synthesized in the 5'-3' direction, is the **primary transcript**. Transcription frequency varies from gene to gene but can be quite high. An electron micrograph of transcription in action is presented in Figure 36-4. In prokaryotes, this can represent the product of several contiguous genes; in mammalian cells, it usually represents the product of a single gene. The 5' termini of the primary RNA transcript and the mature cytoplasmic RNA are identical. Thus, the **transcription start site, or TSS**, corresponds to the 5' nucleotide of the mRNA. This is designated position +1, as is the corresponding nucleotide in the DNA. The numbers increase positively as the

sequence proceeds *downstream* from the start site. This convention makes it easy to locate particular regions, such as intron and exon boundaries. The nucleotide in the promoter adjacent to the transcription initiation site in the upstream direction is designated -1, and these negative numbers increase as the sequence proceeds *upstream*, away from the TSS. This +/- numbering system provides a conventional way of defining the location of regulatory elements in a gene (Figure 36-5).

The primary transcripts generated by RNA polymerase II—one of the three distinct nuclear DNA-dependent RNA polymerases in eukaryotes—are promptly modified by the addition of 7-methyl-guanosine triphosphate caps (see Figure 34-10), which persist and eventually appear on the 5' end of mature cytoplasmic mRNA. These caps are necessary for the subsequent processing of the primary transcript to mRNA, for the translation of the mRNA, and for protection of the mRNA against nucleolytic attack by 5'-exonucleases.

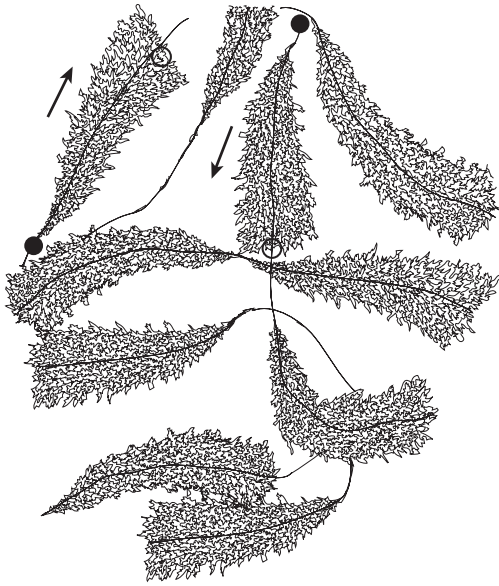

FIGURE 36-4 Schematic representation of an electron photomicrograph of multiple copies of amphibian rRNA-encoding genes in the process of being transcribed. The magnification is about 6000 \times . Note that the length of the transcripts increases as the RNA polymerase molecules progress along the individual rRNA genes from transcription start sites (filled circles) to transcription termination sites (open circles). RNA polymerase I (not visualized here) is at the base of the nascent rRNA transcripts. Thus, the proximal end of the transcribed gene has short transcripts attached to it, while much longer transcripts are attached to the distal end of the gene. The arrows indicate the direction (5'→3') of transcription.

Bacterial DNA-Dependent RNA Polymerase Is a Multisubunit Enzyme

The basic DNA-dependent RNA polymerase, or RNAP, of the bacterium *Escherichia coli* exists as an approximately 400 kDa core complex consisting of two identical α subunits, two

large β and β' subunits, and an ω subunit. The β subunit binds Mg^{2+} ions and composes the catalytic subunit (Figure 36-2). The **core RNA polymerase**, $\beta\beta'\alpha_2\omega$, often termed **E**, associates with a specific protein factor (the **sigma** [σ] **factor**) to form **holoenzyme**, $\beta\beta'\alpha_2\omega\sigma$, or $E\sigma$. The σ subunit enables the core enzyme to recognize and bind the promoter region (Figure 36-5) to form the **preinitiation complex (PIC)**. There are multiple, distinct σ -factor encoding genes in all bacterial species. Sigma factors have a dual role in the process of promoter recognition; σ association with core RNA polymerase decreases its affinity for non-promoter DNA while simultaneously increasing holoenzyme affinity for promoter DNA. The multiple σ -factors compete for interaction with limiting core RNA polymerase (ie, **E**). Each of these unique σ -factors act as a regulatory protein that modifies the promoter recognition specificity of the resulting unique RNA polymerase holoenzyme (ie, $E\sigma_1$, $E\sigma_2$,...). The appearance of different σ -factors and their association with core RNA polymerase to form novel holoenzyme forms $E\sigma_1$, $E\sigma_2$,... can be correlated temporally with various programs of gene expression in prokaryotic systems such as sporulation, growth in various poor nutrient sources and the response to heat shock.

Mammalian Cells Possess Three Distinct Nuclear DNA-Dependent RNA Polymerases

Some of the distinguishing properties of mammalian nuclear polymerases are described in Table 36-2. Each of these DNA-dependent RNA polymerases is responsible for transcription of different sets of genes. The sizes of the RNA polymerases range from MW 500 to 600 kDa. These enzymes exhibit more complex subunit profiles than prokaryotic RNA polymerases. They all have two large subunits, which remarkably bear strong sequence and structural similarities to prokaryotic β and β' subunits, and a number of smaller subunits—as many as 14 in

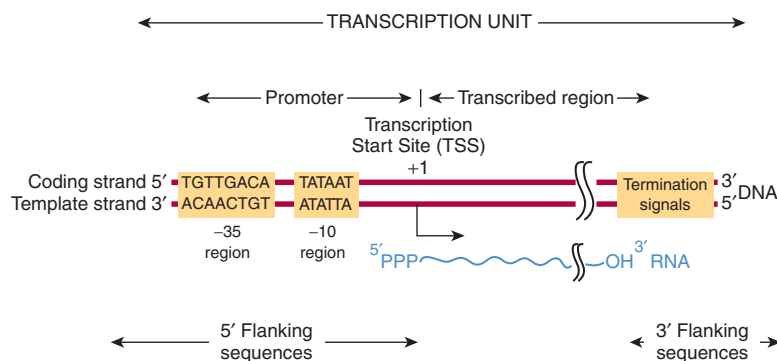

FIGURE 36-5 Prokaryotic promoters share two regions of highly conserved nucleotide sequence. These regions are located 35 and 10 bp upstream of the TSS, which is indicated as +1. By convention, all nucleotides upstream of the transcription initiation site (at +1) are numbered in a negative sense and are referred to as 5'-flanking sequences, while sequences downstream of the +1 TSS are numbered in a positive sense. Also by convention, the promoter DNA regulatory sequence elements such as the -35 and the -10 TATA elements are described in the 5'→3' direction and as being on the coding strand. These elements function only in double-stranded DNA, however. Other transcriptional regulatory elements, however, can often act in a direction independent fashion, and such *cis*-elements are drawn accordingly in any schematic (see also Figure 36-8). Note that the transcript produced from this transcription unit has the same polarity or "sense" (ie, 5'→3' orientation) as the coding strand. Termination *cis*-elements reside at the end of the transcription unit (see Figure 36-6 for more detail). By convention, the sequences downstream of the site at which transcription termination occurs are termed 3'-flanking sequences.

TABLE 36–2 Nomenclature and Properties of Mammalian Nuclear DNA-Dependent RNA Polymerases

Form of RNA Polymerase	Sensitivity to α -Amanitin	Major Products
I	Insensitive	rRNA
II	High sensitivity	mRNA, lncRNA, miRNA, SnRNA
III	Intermediate sensitivity	tRNA, 5s rRNA

the case of RNA pol III. The functions of each of the subunits are not yet fully understood. A peptide toxin from the mushroom *Amanita phalloides*, α -amanitin, is a specific differential inhibitor of the eukaryotic nuclear DNA-dependent RNA polymerases and as such has proved to be a powerful research tool (Table 36–2). α -Amanitin blocks the translocation of RNA polymerase during phosphodiester bond formation.

RNA SYNTHESIS IS A CYCLICAL PROCESS THAT INVOLVES RNA CHAIN INITIATION, ELONGATION, & TERMINATION

The process of RNA synthesis in bacteria—depicted in Figure 36–3—is cyclical and involves multiple steps. First RNA polymerase holoenzyme ($E\sigma$) must locate and then specifically bind a promoter (**P**; Figure 36–3). Once the promoter is located, the $E\sigma$ -promoter DNA complex undergoes a temperature-dependent conformational change and unwinds, or melts the DNA in and around the transcription start site (at +1). This complex is termed the PIC. This unwinding allows the active site of the $E\sigma$ to access the template strand, which of course dictates the sequence of ribonucleotides to be polymerized into RNA. The first nucleotide (typically, though not always a purine) then associates with the nucleotide-binding site of the enzyme, and in the presence of the next appropriate nucleotide bound to the polymerase, RNAP catalyzes the formation of the first phosphodiester bond, and the nascent chain is now attached to the polymerization site on the β subunit of RNAP. This reaction is termed **initiation**. The analogy to the A and P sites on the ribosome should be noted; see Figure 37–9, below. The nascent dinucleotide retains the 5'-triphosphate of the initiating nucleotide (Figure 36–3, ATP).

RNA polymerase continues to incorporate nucleotides +3 to \sim +10, at which point the polymerase undergoes another conformational change and moves away from the promoter; this reaction is termed **promoter clearance**. The **elongation phase** then commences, and here the nascent RNA molecule grows 5'–3' as consecutive NTP incorporation steps continue cyclically, antiparallel to the template. The enzyme polymerizes the ribonucleotides in the specific sequence dictated by the template strand and interpreted by Watson–Crick base-pairing rules. **Pyrophosphate** (PP_i) is released following each cycle of polymerization. As for DNA synthesis, this PP_i is rapidly degraded to two mol of **inorganic phosphate** (P_i) by ubiquitous

pyrophosphatases, thereby providing irreversibility on the overall synthetic reaction. The decision to stay at the promoter in a poised or stalled state, or transition to elongation can be an important regulatory step in both prokaryotic and eukaryotic mRNA gene transcription.

As the **elongation** complex containing RNA polymerase progresses along the DNA molecule, **DNA unwinding** must occur in order to provide access for the appropriate base pairing to the nucleotides of the coding strand. The extent of this transcription bubble (ie, DNA unwinding) is constant throughout transcription and has been estimated to be about 20 bp per polymerase molecule (Figure 36–2). Thus, the size of the unwound DNA region is dictated by the polymerase and is independent of the DNA sequence in the complex. RNA polymerase has an intrinsic “unwindase” activity that opens the DNA helix (ie, see PIC formation above). The fact that the DNA double helix must unwind, and the strands part at least transiently for transcription implies some temporary disruption of the nucleosome structure of eukaryotic cells. Topoisomerase both precedes and follows the progressing RNA polymerase to prevent the formation of superhelical tensions that would serve to increase the energy required to unwind the template DNA ahead of RNAP.

Termination of the synthesis of the RNA molecule in bacteria is signaled by a sequence in the template strand of the DNA molecule—a signal that is recognized by a **termination protein**, the **rho** (ρ) **factor**. Rho is an ATP-dependent RNA-stimulated helicase that disrupts the ternary transcription elongation complex composed of RNA polymerase-nascent RNA and DNA. On some genes, bacterial RNA polymerase can directly recognize DNA-encoded **termination signals** (Figure 36–3; **T**) without assistance by the rho factor. After termination of synthesis of the RNA, the enzyme separates from the DNA template and dissociates to free core enzyme (**E**) and free ρ factor. With the assistance of another σ -factor, the reformed $E\sigma$ holoenzyme then recognizes another promoter whereupon the synthesis of a new RNA molecule commences. In eukaryotic cells, termination is less well understood; however, the proteins catalyzing RNA processing, termination, and polyadenylation all appear to load onto RNA polymerase II soon after initiation (see below). More than one RNA polymerase molecule may transcribe the same template strand of a gene simultaneously, but the process is phased and spaced in such a way that at any one moment each is transcribing a different portion of the DNA sequence (Figures 36–1 and 36–4).

THE FIDELITY & FREQUENCY OF TRANSCRIPTION IS CONTROLLED BY PROTEINS BOUND TO CERTAIN DNA SEQUENCES

Analysis of the DNA sequence of specific genes has allowed the recognition of a number of sequences important in gene transcription. From the large number of bacterial genes studied, it is possible to construct consensus models of transcription initiation and termination signals.

The question, “How does RNAP find the correct site to initiate transcription?” is not trivial when the complexity of the genome is considered. *E. coli* has about 4×10^3 transcription initiation sites (ie, gene promoters) within the 4.2×10^6 bp genome. The situation is even more complex in humans, where as many as 150,000 distinct transcription initiation sites (transcription units) are distributed throughout 3×10^9 bp of DNA. RNAP can bind, with low affinity, to many regions of DNA, but it scans the DNA sequence—at a rate of $\geq 10^3$ bp/s—until it recognizes certain specific regions of DNA to which it binds with higher affinity. These regions are termed promoters, and it is the base-specific association of RNAP with promoters that ensures accurate initiation of transcription. The promoter recognition-utilization process is the target for regulation in both bacteria and humans.

Bacterial Promoters Are Relatively Simple

Bacterial promoters are approximately 40 nucleotides (40 bp or four turns of the DNA double helix) in length, a region small enough to be covered by an *E. coli* RNA holopolymerase molecule. In a consensus promoter, there are two short conserved sequence elements. Approximately 35-bp upstream of the transcription start site there is a consensus sequence of eight nucleotide pairs (consensus: 5'-TGTTGACA-3') to which the RNAP binds to form the so-called **closed complex**. More proximal to the transcription start site—about 10 nucleotides upstream—is a six-nucleotide-pair A+T-rich sequence (consensus: 5'-TATAAT-3'). These conserved sequence elements together comprise the promoter, and are shown schematically in Figure 36-5. The latter sequence has a lower melting temperature because of its lack of GC nucleotide pairs. Thus, the so-called **TATA “box”** is thought to ease the dissociation of the two DNA strands so that RNA polymerase bound to the promoter region can have access to the nucleotide sequence of its

immediately downstream template strand. Once the process of strand separation occurs, the combination of RNA polymerase plus promoter is called the **open complex**. Other bacteria have slightly different consensus sequences in their promoters, but all generally have two components to the promoter; these tend to be in the same position relative to the TSS, and in all cases the sequences between the two promoter elements have no similarity but still **provide critical spacing functions** that facilitate recognition of -35 and -10 sequences by RNA polymerase holoenzyme. Within a bacterial cell, different sets of genes are often coordinately regulated. One important way that this is accomplished is through the fact that these co-regulated genes share particular -35 and -10 promoter sequences. These unique sets of promoters are recognized by different σ -factors bound to core RNA polymerase (ie, $E\sigma_1$, $E\sigma_2$, ...).

Rho-dependent transcription **termination signals** in *E. coli* also appear to have a distinct consensus sequence, as shown in Figure 36-6. The conserved consensus sequence, which is about 40 nucleotide pairs in length, can be seen to contain a hyphenated or interrupted inverted repeat followed by a series of AT base pairs. As transcription proceeds through the hyphenated, inverted repeat, the generated transcript can form the intramolecular hairpin structure, also depicted in Figure 36-6. Transcription continues into the AT region, and with the aid of the ρ termination protein the RNA polymerase stops, dissociates from the DNA template, and releases the nascent transcript.

As discussed in detail in Chapter 38 bacterial gene transcription is controlled through the action of repressor and activator proteins. These proteins typically bind to unique and specific DNA sequences that lie adjacent to promoters. These repressors and activators affect the ability of the RNA polymerase to bind promoter DNA and/or form open complexes. The net effect is to stimulate or inhibit PIC formation and transcription initiation—consequently blocking or enhancing specific RNA synthesis.

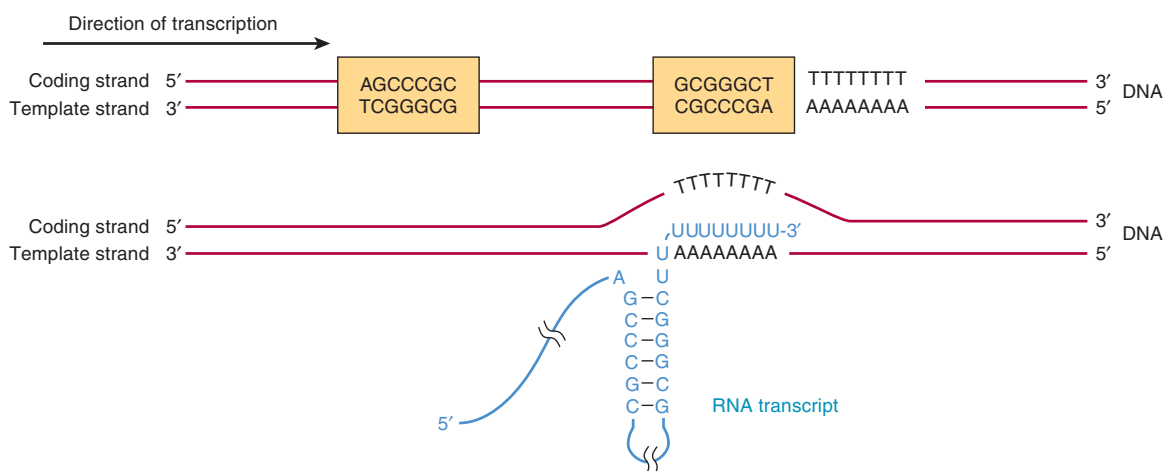

FIGURE 36-6 The predominant bacterial transcription termination signal contains an inverted, hyphenated repeat (the two boxed areas) followed by a stretch of AT base pairs (top). The inverted repeat, when transcribed into RNA, can generate the secondary structure in the RNA transcript (bottom). Formation of this RNA hairpin causes RNA polymerase to pause and subsequently the ρ (rho) termination factor interacts with the paused polymerase and induces chain termination.

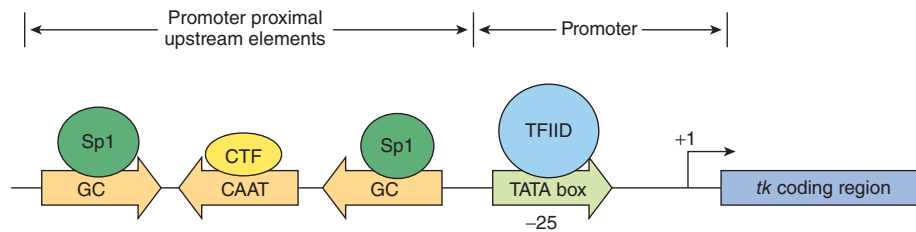

FIGURE 36-7 Transcription elements and binding factors in the herpes simplex virus thymidine kinase (*tk*) gene. DNA-dependent RNA polymerase II (not shown) binds to the region encompassing the TATA box (which is shown here bound by transcription factor TFIID) and TSS at +1 (see also Figure 36-9) to form a multicomponent PIC capable of initiating transcription at a single nucleotide (+1 TSS). The frequency of this event is increased by the presence of upstream *cis*-acting elements (the GC and CAAT boxes) located either near to the promoter (promoter proximal) or distant from the promoter (distal elements; Figure 36-8). Proximal and distal DNA *cis*-elements are bound by *trans*-acting transcriptional activating factors, in this example Sp1 and CTF (also called C/EBP, NF1, NFY). These *cis*-elements can function independently of orientation (arrows).

Eukaryotic Promoters Are More Complex

It is clear that the signals in DNA that control transcription in eukaryotic cells are of several types. **Two types of sequence elements are promoter-proximal.** One of these defines where transcription is to commence along the DNA, and the other contributes to the mechanisms that control how frequently this event is to occur. For example, in the thymidine kinase gene of the herpes simplex virus, which utilizes transcription factors of its mammalian host for its early gene expression program, there is a single unique TSS, and accurate transcription initiation from this site depends upon a nucleotide sequence located about 25 nucleotides upstream from the start site (ie, at -25) (Figure 36-7). This region has the sequence of TATAAAAG and bears remarkable similarity to the functionally related TATA box that is located about

10 bp upstream from the prokaryotic mRNA TSS (Figure 36-5). Mutation or inactivation of the TATA box markedly reduces transcription of this and many other genes that contain this consensus *cis*-active element (see Figures 36-7 and 36-8). The TATA box is usually located 25–30 bp upstream from the transcription start site in mammalian genes that contain it. The consensus sequence for a TATA box is TATAAAA, though numerous variations have been characterized. The human TATA box is bound by the 34 kDa TATA-binding protein (TBP), a subunit in at least two multisubunit complexes, TFIID and SAGA/P-CAF. The non-TBP subunits of TFIID are proteins called TBP-associated factors (TAFs). Binding of the TBP-TAF TFIID complex to the TATA box sequence is thought to represent a first step in the formation of the transcription complex on the promoter.

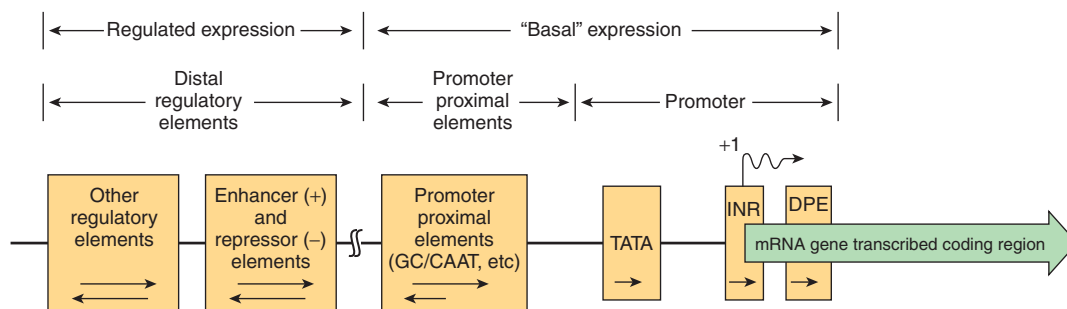

FIGURE 36-8 Schematic showing the transcription control regions in a hypothetical mRNA-producing eukaryotic gene transcribed by RNA polymerase II. Such a gene can be divided into its coding and regulatory regions, as defined by the transcription start site (arrow; +1). The coding region contains the DNA sequence that is transcribed into mRNA, which is ultimately translated into protein, typically after extensive mRNA processing via splicing (Figures 36-12 to 36-16). The regulatory region consists of two classes of elements. One is responsible for ensuring basal expression. The “promoter,” is often composed of the TATA box and/or Inr and/or DPE elements (see Table 36-3), directs RNA polymerase II to the correct site (fidelity). However, in certain genes that lack a consensus TATA, the so-called TATA-less promoters, an initiator (Inr) and/or DPE elements may direct the polymerase to this site. Another component, the upstream elements, specifies the frequency of initiation; such elements can either be proximal (50–200 bp) or distal (1000–10⁵ bp) to the promoter as shown. Among the best studied of the proximal elements is the CAAT box, but several other elements (bound by the transactivator proteins Sp1, NF1, AP1, etc; Table 36-3) may be used in various genes. The distal elements enhance or repress expression, several of which mediate the response to various signals, including hormones, heat shock, heavy metals, and chemicals. Tissue-specific expression also involves specific sequences of this sort. The orientation dependence of all the elements is indicated by the arrows within the boxes. For example, the proximal promoter elements (TATA box, INR, DPE) must be in the 5′→3′ orientation, while the proximal upstream elements often work best in the 5′→3′ orientation, most can be reversed. The locations of some elements are not fixed with respect to the transcription start site. Indeed, some elements responsible for regulated expression can be located interspersed with the upstream elements or can be located downstream from the start site, within, or even downstream of the regulated gene itself.

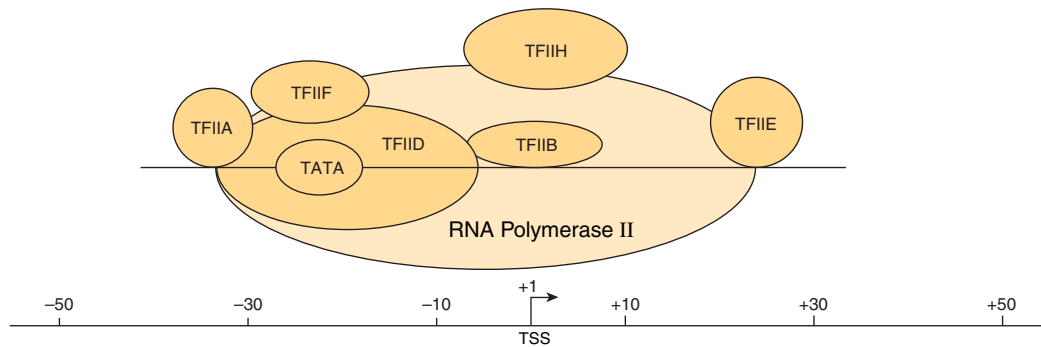

FIGURE 36–9 The eukaryotic basal transcription complex. Formation of the basal transcription complex begins when TFIID binds, via its TATA binding protein (TBP) subunit and several of its 14 TBP-associated Factor (TAF) subunits, to the TATA box. TFIID then directs the assembly of several other components by protein-DNA and protein-protein interactions; TFIIA, B, E, F, H, and polymerase II (pol II). The entire complex spans DNA from position -30 to $+30$ relative to the TSS at $+1$ (marked by bent arrow). The atomic level, X-ray-derived structures of RNA polymerase II alone and of the TBP subunit of TFIID bound to TATA promoter DNA in the presence of either TFIIB or TFIIA have all been solved at 3 \AA resolution. The structures of TFIID and TFIIH complexes have been determined by electron microscopy at 30 \AA resolution, as has the structure of complete TBP-directed pol II+GTF PICs. Thus, the molecular structures of the transcription machinery in action are beginning to be elucidated. Much of this structural information is consistent with the models presented here.

A large number of eukaryotic mRNA-encoding genes lack a consensus TATA box. In such instances, additional DNA *cis*-elements, an **initiator sequence (Inr)** and/or the **downstream promoter element (DPE)**, direct the RNA polymerase II transcription machinery to the promoter and in so doing provide basal transcription starting from the correct site. The Inr element spans the start site (from -3 to $+5$) and consists of the general consensus sequence $\text{TCA}_{+1}\text{G/T T T/C}$ (A_{+1} indicates the first nucleotide transcribed, ie, TSS). The proteins that bind to Inr in order to direct pol II binding include TFIID. Promoters that have both a TATA box and an Inr may be “stronger” or more frequently transcribed than those that have just one of these elements. The DPE has the consensus sequence A/gGA/TCGTG and is localized about 25-bp downstream of the $+1$ TSS. Like the Inr, DPE sequences are also bound by the TAF subunits of TFIID. In a survey of thousands of eukaryotic protein coding genes, roughly 30% contained a TATA box and Inr, 25% contained Inr and DPE, 15% contained all three elements, whereas $\sim 30\%$ contained just the Inr.

Sequences generally, though not always, just upstream from the start site contribute importantly how frequently transcription occurs. Mutations in these regions reduce the frequency of transcription initiation 10-fold to 20-fold. Typical of these DNA elements are the GC and CAAT boxes, so named because of the DNA sequences involved. As illustrated in Figure 36–7, each of these DNA elements are bound by a specific protein, Sp1 in the case of the GC box and CTF by the CAAT box; both bind through their distinct **DNA-binding domains (DBDs)**. The frequency of transcription initiation is a consequence of these protein-DNA interactions and complex interactions between particular domains of the transcription factors (distinct from the DBD domains—so-called **activation domains; ADs**) and the rest of the transcription machinery (RNA polymerase II, the **basal, or general factors, GTFs, TFIIA, B, D, E, F, H** and other coregulatory factors

such as Mediator, chromatin remodelers and chromatin modifying factors). (See below and **Figures 36–9** and **36–10**.) The protein-DNA interactions at the TATA box involving RNA polymerase II and other components of the basal transcription machinery ensures the fidelity of initiation.

Together, the promoter plus promoter-proximal *cis*-active upstream elements confer fidelity and modulate the frequency of initiation upon a gene respectively. The TATA box has a particularly rigid requirement for both position and orientation. As with bacterial promoters, single-base changes in any of these *cis*-elements can have dramatic effects on function by reducing the binding affinity of the cognate *trans*-factors (either TFIID/TBP or Sp1, CTF, and similar factors). The spacing of the TATA box, Inr, and DPE is also critical.

A third class of sequence elements also increase or decrease the rate of transcription of eukaryotic genes. These elements are called either **enhancers** or **repressors (or silencers)**, depending on how they effect transcription. They have been found in a variety of locations, both upstream and downstream of the transcription start site, and even within the transcribed protein coding portions of some genes. Enhancers and silencers can exert their effects when located thousands or even many tens of thousands of bases away from transcription units located on the same chromosome. Surprisingly, enhancers and silencers can function in an orientation-independent fashion. Literally, hundreds of these elements have been described. In some cases, the sequence requirements for binding are rigidly constrained; in others, considerable sequence variation is allowed. Some sequences bind only a single protein; however the majority of these regulatory sequences are bound by several different proteins. Together, these many transactors binding to promoter distal and proximal *cis*-elements regulate transcription in response to a vast array of biological signals. Such transcriptional regulatory events contribute importantly to control of gene expression.

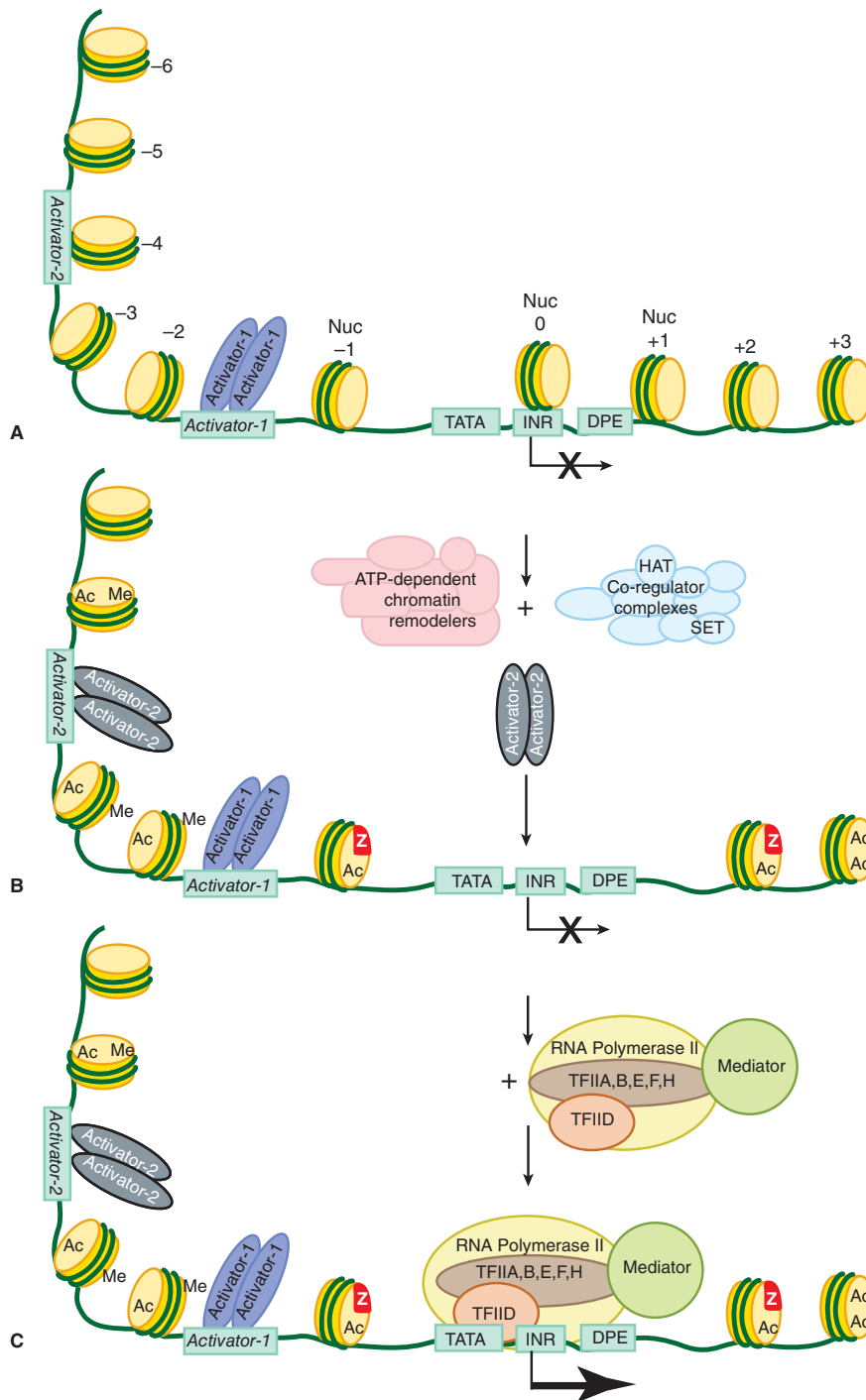

FIGURE 36-10 Nucleosome covalent modifications, remodeling and eviction by chromatin-active coregulators modulate PIC formation and transcription. Shown in **A**, is an inactive mRNA encoding gene (see X over TSS) with a single dimeric transcription factor (*Activator-1*; violet ovals) bound to its cognate enhancer binding site (*Activator-1*). This particular enhancer element was nucleosome-free and hence available for interaction with its cognate activator binding protein. However, this gene is still inactive (X over TSS) due to the fact that a portion of its enhancer (in this illustration the enhancer is bipartite and composed of *Activator-1* and *Activator-2*, DNA-binding sites) and the promoter are covered by nucleosomes. Recall that nucleosomes have ~150 bp of DNA wound around the histone octamer. Hence, the single nucleosome over the promoter will occlude access of the transcription machinery (pol II+GTFs) to the TATA, Inr and/or DPE promoter elements. **(B)** Enhancer DNA-bound *Activator-1* interacts with any of a number of distinct ATP-dependent chromatin remodelers and chromatin-modifying Co-regulator complexes. These coregulators together have the ability to both move, or remodel (ie. change the octameric histone content, and/or remove nucleosomes) through the action of various ATP-dependent remodelers as well as to covalently modify nucleosomal histones using intrinsic acetylases (HAT; resulting in acetylation [Ac]) and methylases (SET; resulting in methylation [Me], among other PTMs; Table 35-1) carried by subunits of these complexes. **(C)** The resulting changes in nucleosome position and nucleosome occupancy (ie. nucleosome -4 and nucleosome 0), composition (nucleosome -1 and nucleosome +1) thus allow for the binding of the second *Activator-2* dimer to *Activator-2* DNA sequences, which leads to the binding of the transcription machinery (TFIIA,B,D,E,F,H; Polymerase II and Mediator) to the promoter (TATA-INR-DPE) and the formation of an active PIC, which leads to activated transcription.

Specific Signals Regulate Transcription Termination

The **signals for the termination of transcription** by eukaryotic RNA polymerase II are only poorly understood. It appears that the termination signals exist far downstream of the coding sequence of eukaryotic genes. For example, the transcription termination signal for mouse β -globin occurs at several positions 1000–2000 bases beyond the site at which the mRNA poly(A) tail will eventually be added. Less is known about the termination process or whether specific termination factors similar to the bacterial ρ factor might be involved. However, it is known that formation of the mRNA 3' terminal, which is generated post-transcriptionally, is somehow coupled to events or structures formed at the time and site of initiation. Moreover, mRNA formation, and in this case mRNA 3'-end formation depends on a special structure present on the C-terminus of the largest subunit of RNA polymerase II, the **C-terminal domain**, or **CTD** (see below), and this process appears to involve at least two steps as follows. After RNA polymerase II has traversed the region of the transcription unit encoding the 3' end of the transcript, RNA endonucleases cleave the primary transcript at a position about 15 bases 3' of the consensus sequence **AAUAAA** that serves in eukaryotic transcripts as a cleavage and polyadenylation signal. Finally, this newly formed 3' terminal is polyadenylated in the nucleoplasm, as described below.

THE EUKARYOTIC TRANSCRIPTION COMPLEX

A complex apparatus consisting of as many as 50 unique proteins provides accurate and regulatable transcription of eukaryotic genes. The RNA polymerase enzymes (pol I, pol II, and pol III) transcribe information contained in the template strand of DNA into RNA. These polymerases must recognize a specific site in the promoter in order to initiate transcription at the proper nucleotide. In contrast to the situation in prokaryotes though, eukaryotic RNA polymerases alone are not able to discriminate between promoter sequences and other, non-promoter regions of DNA in the test tube. All eukaryotic RNA polymerases require other proteins known as general transcription factors or GTFs. RNA polymerase II requires TFIIA, B, D (or TBP), E, F, and H to both facilitate promoter-specific binding of the enzyme and formation of the PIC. RNA polymerases I and III require their own polymerase-specific GTFs. Moreover, RNA polymerase II and GTFs do not respond to activator proteins and can only catalyze basal or (non)-unregulated transcription *in vitro*. Another set of proteins—the **coactivators**, or **coregulators**—work in conjunction with the DNA-binding transactivator proteins described above to communicate with Pol II/GTFs to regulate the rate of transcription (see below).

Formation of the Pol II Transcription Complex

In bacteria, a σ -factor–polymerase holoenzyme complex, $E\sigma$, selectively and directly binds to promoter DNA to form the PIC. The situation is much more complex in eukaryotic genes. mRNA-encoding genes, which are transcribed by pol II, are described as an example. In the case of pol II-transcribed genes, the function of σ -factors is assumed by a number of proteins. PIC formation requires pol II and the six GTFs (TFIIA, TFIIB, TFIID, TFIIE, TFIIIF, TFIIF). These GTFs serve to promote RNA polymerase II transcription on essentially all genes. Some of these GTFs are composed of multiple subunits. **TFIID**, which binds to the TATA box promoter element through its TBP subunit, is the only one of these factors that is independently capable of specific, high affinity binding to promoter DNA. TFIID consists of 15 subunits, TBP and 14 TBP Associated Factors, or TAFs.

TBP binds to the TATA box in the minor groove of DNA (most transcription factors bind in the major groove) and causes an approximately 100-degree bend or kink of the DNA helix. This bending is thought to facilitate the interaction of TAFs with other components of the transcription initiation complex, the multicomponent eukaryotic promoter and possibly with factors bound to upstream elements. Although initially defined as a component solely required for transcription of pol II gene promoters, TBP, by virtue of its association with distinct, polymerase-specific sets of TAFs, is also an important component of pol I and pol III transcription initiation complexes even if they do not contain TATA boxes.

The binding of TFIID marks a specific promoter for transcription. Of several subsequent *in vitro* steps, the first is the binding of TFIIA, then TFIIB to the TFIID-promoter complex. This results in a stable ternary complex, which is then more precisely located and more tightly bound at the transcription initiation site. This complex then attracts and tethers the pol II–TFIIF complex to the promoter. Addition of TFIIE and TFIIF are the final steps in the assembly of the PIC. TFIIE appears to join the complex with pol II–TFIIF, and TFIIF is then recruited. Each of these binding events extends the size of the complex so that finally about 60 bp (from –30 to +30 relative to the +1 TSS) are covered (Figure 36–9). The PIC is now complete and capable of basal transcription initiated from the correct nucleotide. In genes that lack a TATA box, the same factors are required. In such cases, the Inr and/or DPE serve to (see Figure 36–8) position the complex for accurate initiation of transcription.

Promoter Accessibility and Hence PIC Formation Is Often Modulated by Nucleosomes

On certain eukaryotic genes, the transcription machinery (pol II, etc.) cannot access the promoter sequences (ie, TATA–INR–DPE) because these essential promoter elements are wrapped

up in nucleosomes (see Figures 35–2, 35–3 and 36–10). Only after transcription factors bind to enhancer DNA upstream of the promoter and recruit chromatin remodeling and modifying coregulatory factors such as the Swi/Snf, SRC-1, p300/CBP (see Chapter 42) P/CAF or other factors, are the repressing nucleosomes removed (Figure 36–10). Once the promoter is “open” following nucleosome eviction, GTFs and RNA polymerase II can bind and initiate mRNA gene transcription. Note that the binding of transactivators and coregulators can be sensitive to, and/or directly control the composition and/or covalent modification status of the DNA and the histones within the nucleosomes in and around the promoter and enhancer, and thereby increase or decrease the ability of all the other components required for PIC formation to interact with a particular gene. This so-called **epigenetic code of DNA, histone and protein modifications** can contribute importantly to gene transcription control. Indeed, mutations in proteins that catalyze (code writers), remove (code erasers), or differentially bind (code readers) modified DNA and/or histones can lead to human disease.

Phosphorylation Activates Pol II

Eukaryotic pol II consists of 12 subunits. As noted above the two largest subunits of pol II (MW 220 and 150 kDa) are homologous to the bacterial β' and β subunits. In addition to the increased number of subunits, eukaryotic pol II differs from its prokaryotic counterpart in that it has a series of heptad repeats with consensus sequence Tyr-Ser-Pro-Thr-Ser-Pro-Ser at the carboxyl terminus of the largest pol II subunit. This **carboxy terminal domain (CTD)** has 26 repeated units in yeast and 52 units in mammals. The CTD is a substrate for several enzymes (kinases, phosphatases, prolyl isomerases, glycosylases); phosphorylation of the CTD was the first CTD PTM discovered. Among other proteins the kinase subunit of TFIIH can modify the CTD. Covalently modified CTD is the binding site for a wide array of proteins, and it has been shown to interact with many mRNA modifying and processing enzymes and nuclear transport proteins. The association of these factors with the CTD of RNA polymerase II (and other components of the basal machinery) thus serves to couple transcription initiation with mRNA capping, splicing, 3' end formation and transport to the cytoplasm (see below). Pol II polymerization is activated when phosphorylated on the Ser and Thr residues and displays reduced activity when the CTD is dephosphorylated. CTD phosphorylation/dephosphorylation is critical for promoter clearance, elongation, termination, and even appropriate mRNA processing. Pol II lacking the CTD tail is incapable of activating transcription, and cells expressing pol II lacking the CTD are inviable. These results underscore the importance of this domain to mRNA biogenesis.

Pol II can associate with other proteins termed **Mediator** or **Med** proteins to form a complex sometimes referred to as the pol II holoenzyme; this complex can form on the promoter or in solution prior to PIC formation (see below). The Med proteins (over 30 proteins; Med1–Med31) are essential for appropriate regulation of pol II transcription by serving myriad roles,

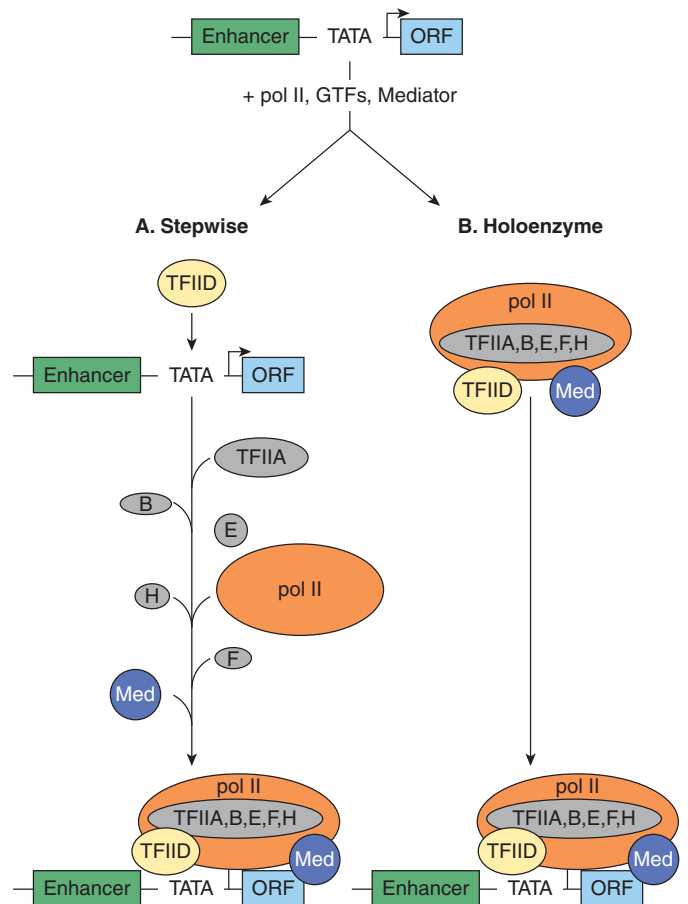

FIGURE 36–11 Models for the formation of an RNA polymerase II preinitiation complex. Shown at top is a typical mRNA encoding gene transcription unit: enhancer-promoter (TATA)-TSS (bent arrow) and ORF (open reading frame) within the transcribed region. PICs have been shown to form by at least two distinct mechanisms: **(A)** the stepwise binding of GTFs, pol II, and Mediator (Med), or **(B)** by the binding of a single multiprotein complex composed of pol II, Med, and the six GTFs. DNA-binding transactivator proteins specifically bind enhancers and in part facilitate PIC formation (or PIC function) by binding directly to the TFIIID-TAF subunits or Med subunits of Mediator (not shown, see Figure 36–10); the molecular mechanism(s) by which such protein–protein interactions stimulate transcription remain a subject of intense investigation.

both activating and repressing transcription. Thus Mediator, like TFIIID is a transcriptional coregulator (**Figure 36–11**).

The Role of Transcription Activators & Coregulators

TFIIID was originally considered to be a single protein, TBP. However, several pieces of evidence led to the important discovery that TFIIID is actually a complex consisting of TBP and the 14 TAFs. The first evidence that TFIIID was more complex than just the TBP molecules came from the observation that TBP binds to a 10-bp segment of DNA, immediately over the TATA box of the gene, whereas native holo-TFIIID covers a 35 bp or larger region (Figure 36–9). Second, purified recombinant *E. coli*-expressed TBP has a molecular mass of 20–40 kDa

TABLE 36-3 Some of the Mammalian RNA Polymerase II Transcription Control Elements, Their Consensus Sequences, and the Factors That Bind to Them

Element	Consensus Sequence	Factor
TATA box	TATAAA	TBP/TFIID
Inr	T/CT/cANt/AT/CT/C	TFIID
DPE	A/GGA/tCGTG	TFIID
CAAT box	CCAATC	C/EBP*, NF-Y*
GC box	GGGCGG	Sp1*
	CAACTGAC	Myo D
	T/cGGA/cN ₅ GCCAA	NF1*
Ig octamer	ATGCAAAT	Oct1, 2, 4, 6*
AP1	TGAg/cTC/AA	Jun, Fos, ATF*
Serum response	GATGCCATA	SRF
Heat shock	(NGAAN) ₃	HSF

Note: All elements listed are written 5' to 3' and only the top strand of the duplex element is shown. A complete list would include hundreds of examples. The asterisks signify that there are several members of this family. Nucleotides separated by a / indicate that either of two nucleotides can be at that position (ie, T/C in the Inr first position implies that either T or C can occupy that position; N, implies any of the four DNA bases A, G, C or T can occupy that particular position in the indicated cis-element.

(depending on the species), whereas the native TFIID complex has a mass of about 1000 kDa. Finally, and perhaps most importantly, TBP supports basal transcription but not the augmented transcription provided by certain activators, for example, Sp1 bound to the GC box. TFIID, on the other hand, supports both basal and enhanced transcription by Sp1, Oct1, AP1, CTF, ATF, etc. (Table 36-3). The TAFs are essential for this activator-enhanced transcription. There are likely several forms of TFIID that differ slightly in their complement of TAFs. Thus different combinations of TAFs with TBP—or one of several recently discovered TBP-like factors (TLFs)—bind to different promoters, and recent reports suggest that this may account for the tissue or cell-selective gene activation noted in various promoters and for the different strengths of certain promoters. TAFs, since they are required for the action of activators, are often called coactivators or coregulators. There are thus three classes of transcription factors involved in the regulation of pol II genes: pol II and GTFs, coregulators, and DNA-binding activator-repressors (Table 36-4). How these classes of proteins interact to govern both the site and frequency of transcription is a question of central importance and active investigation. It is currently thought that coregulators both act as a bridge between the DNA-binding transactivators and pol II/GTFs, and act to modify chromatin.

Two Models Can Explain the Assembly of the Preinitiation Complex

The formation of the PIC described above is based on the sequential addition of purified components as observed

TABLE 36-4 Three Classes of Transcription Factors Involved in mRNA Gene Transcription

General Mechanisms	Specific Components
Basal components	RNA Polymerase II, TBP, TFIIA, B, D, E, F, and H
Coregulators	TAFs (TBP + TAFs) = TFIID; certain genes
	Mediator, Meds
	Chromatin modifiers
	Chromatin remodelers
Activators	SP1, ATF, CTF, AP1, etc

through in vitro experiments. An essential feature of this model is that PIC assembly takes place on a DNA template where the transcription proteins all have ready access to DNA. Accordingly, transcription activators, which have autonomous DNA binding and activation domains (see Chapter 38), are thought to function by stimulating PIC formation. Here the TAF or mediator complexes are viewed as bridging factors that communicate between the upstream-bound activators, and the GTFs and pol II. This view assumes that there is **step-wise assembly** of the PIC—promoted by various interactions between activators, coactivators, and PIC components, and is illustrated in panel A of Figure 36-11. This model is supported by observations that many of these proteins can indeed bind to one another in vitro.

Recent evidence suggests that there is another possible mechanism of PIC formation and thus transcription regulation. First, large preassembled complexes of GTFs and pol II are found in cell extracts, and these complexes can associate with the promoter in a single step. Second, the rate of transcription achieved when activators are added to limiting concentrations of pol II holoenzyme can be matched by artificially increasing the concentration of pol II and GTFs in the absence of activators. Thus, at least in vitro, one can establish conditions where activators are not in themselves absolutely essential for PIC formation. These observations led to the **“recruitment” hypothesis**, which has now been tested experimentally. Simply stated, the role of activators and some coactivators may be solely to recruit a preformed holoenzyme-GTF complex to the promoter. The requirement for an activation domain is circumvented when either a component of TFIID or the pol II holoenzyme is artificially tethered, using recombinant DNA techniques, to the DBD of an activator. This anchoring, through the DBD component of the activator molecule, leads to a transcriptionally competent structure, and there is no further requirement for the activation domain of the activator. In this view, the role of activation domains is to direct preformed holoenzyme-GTF complexes to the promoter; they do not assist in PIC assembly (see panel B, Figure 36-11). In this model, the efficiency of the recruitment process directly determines the rate of transcription at a given promoter.

RNA MOLECULES ARE PROCESSED BEFORE THEY BECOME FUNCTIONAL

In prokaryotic organisms, the primary transcripts of mRNA-encoding genes begin to serve as translation templates even before their transcription has been completed. This can occur because the site of transcription is not compartmentalized into the nucleus as it is in eukaryotic organisms. Thus, transcription and translation are coupled in prokaryotic cells. Consequently, prokaryotic mRNAs are subjected to little processing prior to carrying out their intended function in protein synthesis. Indeed, appropriate regulation of some genes (eg, the *Trp* operon) relies upon this coupling of transcription and translation. Prokaryotic rRNA and tRNA molecules are transcribed in units considerably longer than the ultimate molecule. In fact, many of the tRNA transcription units encode more than one tRNA molecule. Thus, in prokaryotes, the processing of these rRNA and tRNA precursor molecules is required for the generation of the mature functional molecules.

Nearly all eukaryotic RNA primary transcripts undergo extensive processing between the time they are synthesized and the time at which they serve their ultimate function, whether it be as mRNA, miRNAs, or as a component of the translation machinery such as rRNA or tRNA. Processing

occurs primarily within the nucleus. The processes of **transcription, RNA processing, and even RNA transport from the nucleus, are highly coordinated.** Indeed, a transcriptional coactivator termed SAGA in yeasts and P/CAF in human cells is thought to link transcription activation to RNA processing by recruiting a second complex termed TREX to transcription elongation, splicing, and nuclear export. **TREX (transcription-export)** represents a likely molecular link between transcription elongation complexes, the RNA splicing machinery, and nuclear export (see **Figure 36–12**). This coupling presumably dramatically increases both the fidelity and rate of processing and movement of mRNA to the cytoplasm for translation.

The Coding Portions (Exons) of Most Eukaryotic Genes Are Interrupted by Introns

The RNA sequences that appear in mature RNAs are termed **exons**. In mRNA encoding genes exons are often interrupted by long sequences of DNA that neither appear in mature mRNA, nor contribute to the genetic information ultimately translated into the amino acid sequence of a protein molecule (see Chapter 35). In fact, these sequences often interrupt the coding region of structural genes. These **intervening sequences, or introns**, exist within most but not all mRNA encoding genes of higher

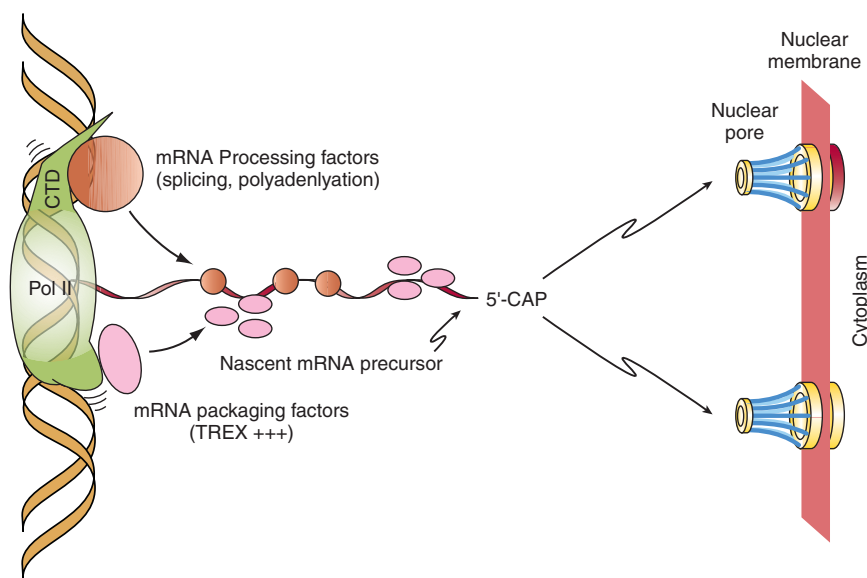

FIGURE 36–12 RNA polymerase II-mediated mRNA gene transcription is cotranscriptionally coupled to RNA processing and transport. Shown is RNA pol II actively transcribing an mRNA encoding gene (elongation top to bottom of figure). RNA processing factors (ie, SR/RRM-motif-containing splicing factors as well as polyadenylation and termination factors) interact with the C-terminal domain (CTD), composed of multiple copies of a heptapeptide with consensus sequence $-YSP\text{TSPS}-$ of pol II, while mRNA packaging factors such as THO/TREX complex (pink ovals) are recruited to the nascent mRNA primary transcript either through direct pol II interactions as shown or through interactions with SR/splicing factors (brown circles) resident on the nascent mRNA. Note that the CTD is not drawn to scale. The evolutionarily conserved CTD of the Rpb1 subunit of pol II is in reality 5–10 times the length of the polymerase due to its many prolines and consequent unstructured nature, and thus a significant docking site for RNA processing and transport proteins. In both cases, nascent mRNA chains are thought to be more rapidly and accurately processed due to the immediate recruitment of these many factors to the growing mRNA (precursor) chain. Following appropriate mRNA processing, the mature mRNA is delivered to the nuclear pores (Figures 36–17; 46–4) dotting the nuclear membrane, where, upon transport through the pores, the mRNAs can be engaged by ribosomes and translated into protein. (Adapted from Jensen et al: *Mol Cell*. 2005;11:1129–1138.)

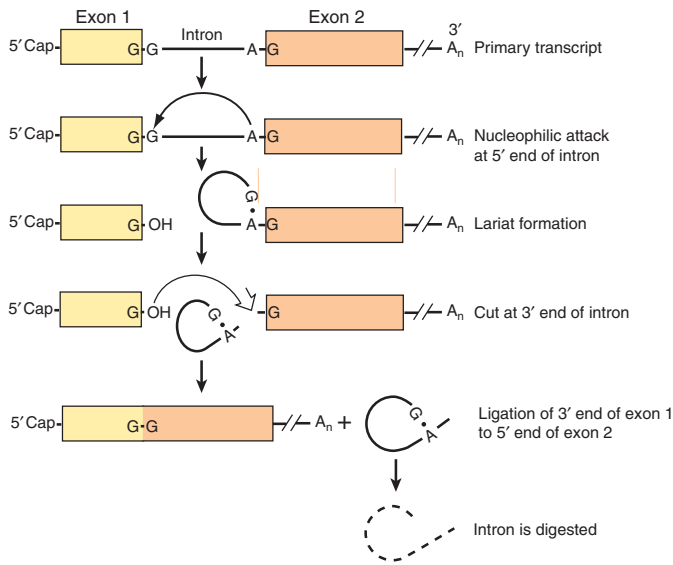

FIGURE 36-13 The processing of the primary transcript to mRNA. In this hypothetical transcript, the 5' (left) end of the intron is cut (→) and a structure resembling a lariat forms between the G at the 5' end of the intron and an A near the 3' end, in the consensus sequence UACUAAC. This sequence is called the branch site, and it is the 3' most A that forms the 5'–2' bond with the G. The 3' (right) end of the intron is then cut (↓). This releases the lariat, which is digested, and exon 1 is joined to exon 2 at G residues.

eukaryotes. In human mRNA encoding genes, exons average ~150 nt, while introns are much more heterogeneous, ranging from 10–100 nt to 30,000 nucleotides in length. The intron RNA sequences are cleaved out of the transcript, and the exons of the transcript are appropriately spliced together in the nucleus before the resulting mRNA molecule appears in the cytoplasm for translation (Figures 36-13 and 36-14).

Introns Are Removed & Exons Are Spliced Together

Several different splicing reaction mechanisms for intron removal have been described. The one most frequently used in eukaryotic cells is described below. Although the sequences of nucleotides in the introns of the various eukaryotic transcripts—and even those within a single transcript—are quite heterogeneous, there are reasonably conserved sequences at each of the two exon–intron (splice) junctions and at the branch site, which is located 20–40 nucleotides upstream from the 3' splice site (see consensus sequences in Figure 36-14). A special multicomponent complex, the **spliceosome**, is involved in

converting the primary transcript into mRNA. Spliceosomes consist of the primary transcript, five snRNAs (U1, U2, U4, U5, and U6) and more than 60 proteins, many of which contain conserved **RRM (RNA recognition)** and **SR (serine-arginine)** protein motifs. Collectively, the five snRNAs and RRM/SR-containing proteins form a **small nuclear ribonucleoprotein** termed a **snRNP complex**. It is likely that this penta-snRNP spliceosome forms prior to interaction with mRNA precursors. snRNPs are thought to position the exon and intron RNA segments for the necessary splicing reactions. The splicing reaction starts with a cut at the junction of the 5'-exon (donor or left) and intron (Figure 36-13). This is accomplished by a nucleophilic attack by an adenylyl residue in the branch point sequence located just upstream from the 3' end of this intron. The free 5' terminal then forms a loop or lariat structure that is linked by an unusual 5'–2' phosphodiester bond to the reactive A in the PyNPyPyPuAPy branch site sequence (Figure 36-14). This adenylyl residue is typically located 20–30 nucleotides upstream from the 3' end of the intron being removed. The branch site identifies the 3' splice site. A second cut is made at the junction of the intron with the 3' exon (donor on right). In this second transesterification reaction, the 3' hydroxyl of the upstream exon attacks the 5' phosphate at the downstream exon–intron boundary, and the lariat structure containing the intron is released and hydrolyzed. The 5' and 3' exons are ligated to form a continuous sequence.

The snRNAs and associated proteins are required for formation of the various structures and intermediates. U1 within the snRNP complex binds first by base pairing to the 5' exon–intron boundary. U2 within the snRNP complex then binds by base pairing to the branch site, and this exposes the nucleophilic A residue. U4/U5/U6 within the snRNP complex mediates an ATP-dependent protein-mediated unwinding that results in disruption of the base-paired U4–U6 complex with the release of U4. U6 is then able to interact first with U2, then with U1. These interactions serve to approximate the 5' splice site, the branch point with its reactive A, and the 3' splice site. This alignment is enhanced by U5. This process also results in the formation of the loop or lariat structure. The two ends are cleaved, probably by the U2–U6 within the snRNP complex. U6 is certainly essential, since yeasts deficient in this snRNA are not viable. It is important to note that RNA serves as the catalytic agent. This sequence of events is then repeated in genes containing multiple introns. In such cases, a definite pattern is followed for each gene, though the introns are not necessarily removed in sequence—1, then 2, then 3, etc.

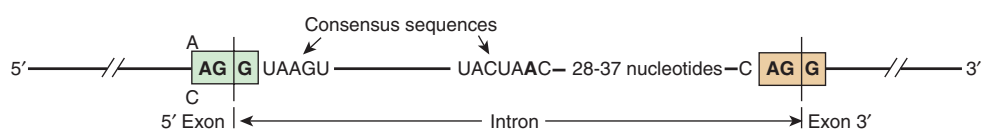

FIGURE 36-14 Consensus sequences at splice junctions. The 5' (donor; left) and 3' (acceptor; right) sequences are shown. Also shown is the yeast consensus sequence (UACUAAC) for the branch site. In mammalian cells, this consensus sequence is PyNPyPyPuAPy, where Py is a pyrimidine, Pu is a purine, and N is any nucleotide. The branch site is located 20–40 nucleotides upstream from the 3' splice site.

Alternative Splicing Provides for Different mRNAs

The processing of mRNA molecules is a site for regulation of gene expression. Alternative patterns of mRNA splicing result from tissue-specific adaptive and developmental control mechanisms. Interestingly, recent studies suggest that alternative splicing is controlled, at least in part, through chromatin epigenetic marks (ie, Table 35–1). This form of coupling of transcription and mRNA processing may either be kinetic and/or mediated through interactions between specific histone PTMs and alternative splicing factors that can load onto nascent mRNA gene transcripts during the process of transcription (Figure 36–12).

As mentioned above, the sequence of exon–intron splicing events generally follows a hierarchical order for a given gene. The fact that very complex RNA structures are formed during splicing—and that a number of snRNAs and proteins are involved—affords numerous possibilities for a change of this order and for the generation of different mRNAs. Similarly, the use of alternative termination–cleavage polyadenylation sites also results in mRNA variability. Some schematic examples of these processes, all of which occur in nature, are shown in Figure 36–15.

Faulty splicing can cause disease. At least one form of β -thalassemia, a disease in which the β -globin gene of hemoglobin is severely under-expressed, appears to result from a nucleotide change at an exon–intron junction, precluding removal of the intron and therefore leading to diminished or absent synthesis of the β -chain protein. This is a consequence of the fact that the normal translation reading frame of the mRNA is disrupted by a defect in the fundamental process of RNA splicing, underscoring the accuracy that the process of RNA–RNA splicing must maintain.

Alternative Promoter Utilization Provides a Form of Regulation

Tissue-specific regulation of gene expression can be provided by alternative splicing, as noted above, by control elements in the promoter or by the use of alternative promoters. The

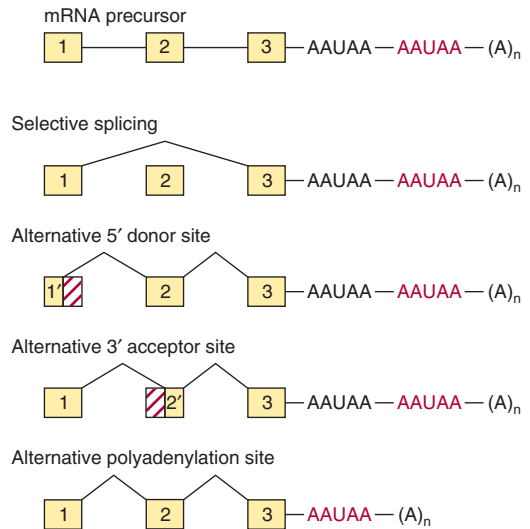

FIGURE 36–15 Mechanisms of alternative processing of mRNA precursors. This form of mRNA processing involves the selective inclusion or exclusion of exons, the use of alternative 5' donor or 3' acceptor sites, and the use of different polyadenylation sites, and dramatically increases the differential protein coding potential of the genome.

glucokinase (*GK*) gene consists of 10 exons interrupted by 9 introns. The sequence of exons 2–10 is identical in liver and pancreatic β cells, the primary tissues in which *GK* protein is expressed. Expression of the *GK* gene is regulated very differently—by two different promoters—in these two tissues. The liver promoter and exon 1L are located near exons 2–10; exon 1L is ligated directly to exon 2. By contrast, the pancreatic β -cell promoter is located about 30 kbp upstream. In this case, the 3' boundary of exon 1B is ligated to the 5' boundary of exon 2. The liver promoter and exon 1L are excluded and removed during the splicing reaction (see Figure 36–16). The existence of multiple distinct promoters allows for cell- and tissue-specific expression patterns of a particular gene (mRNA). In the case of *GK*, insulin and cAMP (see Chapter 42) control *GK* transcription in liver, while glucose controls *GK* expression in β cells.

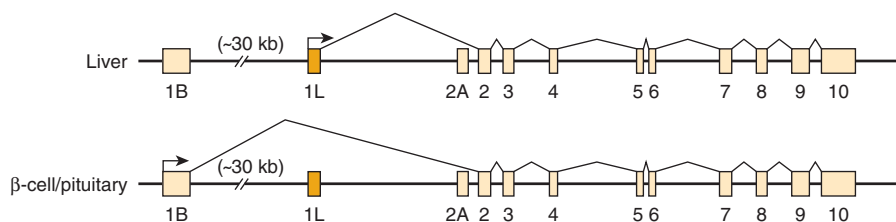

FIGURE 36–16 Alternative promoter use in the liver and pancreatic β -cell glucokinase (*GK*) genes. Differential regulation of the glucokinase gene is accomplished by the use of tissue-specific promoters. The β -cell *GK* gene promoter and exon 1B are located about 30 kbp upstream from the liver promoter and exon 1L. Each promoter has a unique structure and is regulated differently. Exons 2–10 are identical in the two genes, and the *GK* proteins encoded by the liver and β -cell mRNAs have identical kinetic properties.

Both Ribosomal RNAs & Most Transfer RNAs Are Processed from Larger Precursors

In mammalian cells, the three rRNA molecules (28S, 18S, 5.8S) are transcribed as part of a single large 45S precursor molecule. **The precursor is subsequently processed in the nucleolus** to provide these three RNA components for the ribosome subunits found in the cytoplasm. The rRNA genes are located in the nucleoli of mammalian cells. Hundreds of copies of these genes are present in every cell. This large number of genes is required to synthesize sufficient copies of each type of rRNA to form the 10^7 ribosomes required for each cell replication. Whereas a single mRNA molecule may be copied into 10^5 protein molecules, providing a large amplification, the rRNAs are end products. This lack of amplification requires both a large number of genes and a high transcription rate, typically synchronized with cell growth rate. Similarly, tRNAs are often synthesized as precursors, with extra sequences both 5' and 3' of the sequences comprising the mature tRNA. A small fraction of tRNAs contain introns.

RNAs CAN BE EXTENSIVELY MODIFIED

Essentially all RNAs are covalently modified after transcription. It is clear that at least some of these modifications are regulatory.

Messenger RNA Is Modified at the 5' & 3' Ends

As mentioned above, eukaryotic mRNA molecules contain a **7-methylguanosine cap structure** at their 5' terminal (see Figure 34–10), and most have a **poly(A) tail** at the 3' terminal. The cap structure is added to the 5' end of the newly transcribed mRNA precursor in the nucleus very soon after synthesis and prior to transport of the mRNA molecule to the cytoplasm. The 5' cap of the RNA transcript is required both for efficient translation initiation and protection of the 5' end of mRNA from attack by 5' → 3' exonucleases. The secondary methylations of mRNA molecules, those on the 2'-hydroxy and the N⁷ of adenylyl residues, occur after the mRNA molecule has appeared in the cytoplasm.

Poly(A) tails are added to the 3' end of mRNA molecules in a posttranscriptional processing step. The mRNA is first cleaved about 20 nucleotides downstream from an AAUAA recognition sequence. Another enzyme, **poly(A) polymerase**, adds a poly(A) tail which is subsequently extended to as many as 200 A residues. The poly(A) tail both protects the 3' end of mRNA from 3' → 5' exonuclease attack and facilitates translation. The presence or absence of the poly(A) tail does not determine whether a precursor molecule in the nucleus appears in the cytoplasm, because all poly(A)-tailed nuclear mRNA molecules do not contribute to cytoplasmic mRNA, nor do all cytoplasmic mRNA molecules contain poly(A) tails

(histone mRNAs are most notable in this regard). Following nuclear transport cytoplasmic enzymes in mammalian cells can both add and remove adenylyl residues from the poly(A) tails; this process has been associated with an alteration of mRNA stability and translatability.

The size of some cytoplasmic mRNA molecules, even after the poly(A) tail is removed, is still considerably greater than the size required to code for the specific protein for which it is a template, often by a factor of 2 or 3. The extra nucleotides occur in untranslated (nonprotein coding) exonic regions both 5' and 3' of the coding region; the longest untranslated sequences are usually at the 3' end. The **5' UTR and 3' UTR** sequences have been implicated in RNA processing, transport, storage, degradation, and translation; each of these reactions potentially contributes additional levels of control of gene expression. Some of these posttranscriptional events involving mRNAs occur in cytoplasmic organelles termed P bodies (Chapter 37).

Micro-RNAs Are Derived from Large Primary Transcripts Through Specific Nucleolytic Processing

The majority of miRNAs are transcribed by RNA pol II into **primary transcripts** termed **pri-miRNAs**. pri-miRNAs are 5'-capped and 3'-polyadenylated (Figure 36–17). pri-miRNAs are synthesized from transcription units encoding one or several distinct miRNAs; these transcription units are either located independently in the genome or within the intronic DNA of other genes. Given this organization miRNA-encoding genes must therefore minimally possess a distinct promoter, coding region and polyadenylation/termination signals. pri-miRNAs have extensive 2° structure, and this intramolecular structure is maintained following processing by the **Drosha-DGCR8 nuclease**; the portion containing the RNA hairpin is preserved, transported through the nuclear pore via the action of exportin 5, and once in the cytoplasm, further processed by the heterodimeric **dicer nuclease-TRBP complex** to a **21 or 22-mer**. Ultimately, one of the two strands is selected for loading into the **RNA-induced silencing complex (RISC)**, which is composed of one of four **Argonaute proteins (Ago 1→4)**, to form a mature, functional 21-22 nt single stranded miRNA. siRNAs are produced similarly. Once in the RISC complex, miRNAs can modulate mRNA function by one of three mechanisms: (a) promoting mRNA degradation directly; (b) stimulating CCR4/NOT complex-mediated poly A tail degradation; or (c) inhibition of translation by targeting the 5'-methyl cap binding translation factor eIF4 (Figures 37–7 and 37–8) or the ribosome directly. Recent data suggest that regulatory miRNA-encoding genes may be linked, and hence co-evolve with their target genes.

RNA Editing Changes mRNA After Transcription

The central dogma states that for a given gene and gene product there is a linear relationship between the coding sequence in DNA, the mRNA sequence, and the protein sequence

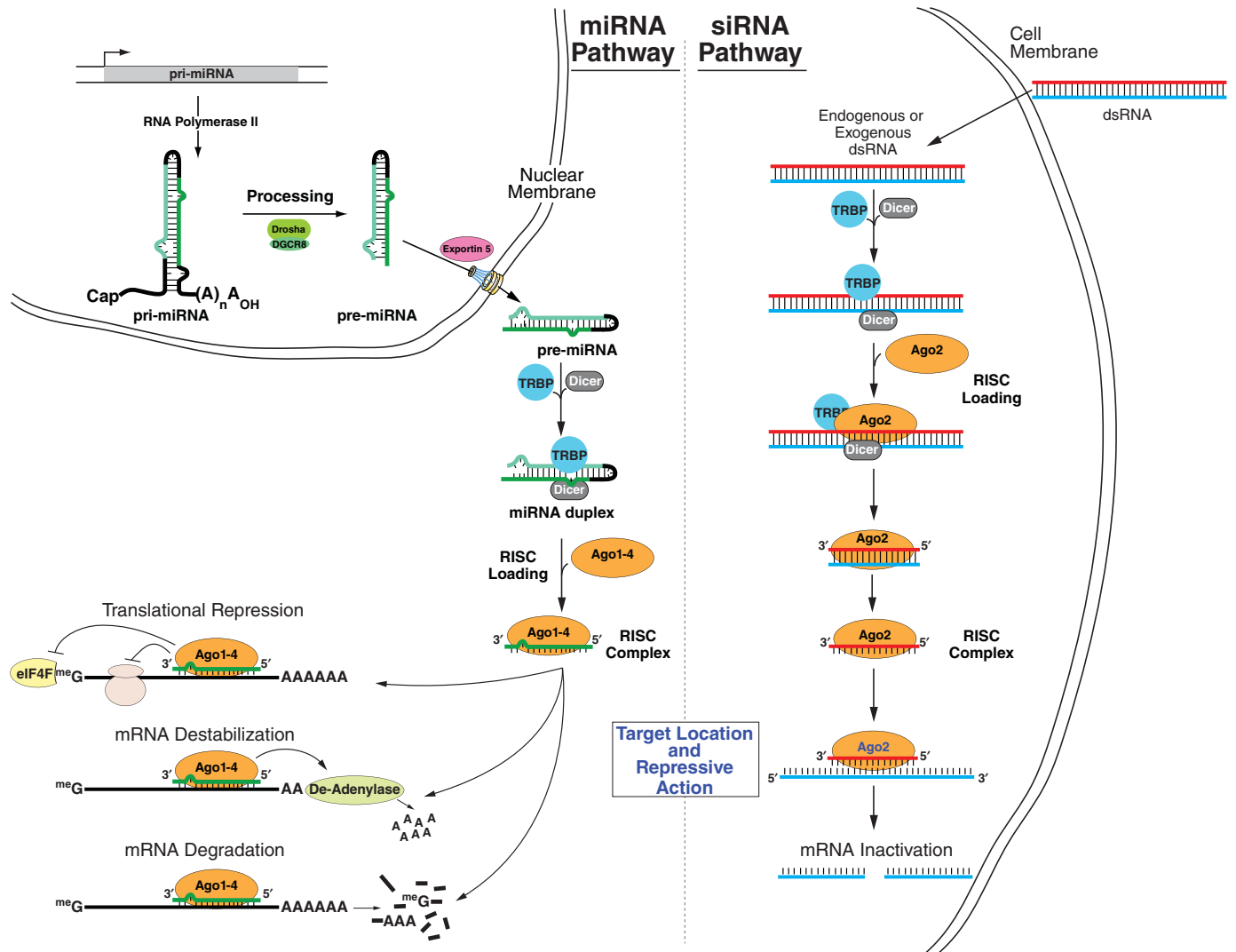

FIGURE 36-17 Biogenesis of micro (mi) and silencing (si)RNAs. (Left) miRNA encoding genes are transcribed by RNA pol II into a primary miRNA (pri-miRNA), which is 5'-capped and polyadenylated as is typical of mRNA coding primary transcripts. This pri-miRNA is subjected to processing within the nucleus by the action of the Drosha-DGCR8 nuclease, which trims sequences from both 5' and 3' ends to generate the pre-miRNA. This partially processed double-stranded RNA is transported through the nuclear pore by exportin-5. The cytoplasmic pre-miRNA is then trimmed further by the action of the heterodimeric nuclease termed Dicer (TRBP-Dicer), to form the 21–22 nt miRNA duplex. One of the two resulting 21–22 nucleotide-long RNA strands is selected, the duplex unwound, and the selected strand loaded into the RNA induced silencing complex, or RISC complex thereby generating the mature, functional miRNA. Following target mRNA location and sequence-specific miRNA-mRNA annealing, the functional miRNA can modulate mRNA function by one of three mechanisms: translational repression, mRNA destabilization by mRNA deadenylation, or mRNA degradation. (Right) The siRNA pathway generates functional siRNAs from large double stranded RNAs that are formed either intracellularly by RNA-RNA hybridization (inter- or intramolecular) or from extracellular sources such as RNA viruses. These viral dsRNAs are again processed to ~22 nt siRNA dsRNA segments via the heterodimeric Dicer nuclease, loaded into the Ago2-containing RISC complex, one strand is then selected to generate the siRNA that locates target RNA sequences via sequence-specific siRNA-RNA annealing. This ternary target RNA-siRNA-Ago2 complex induces RNA cleavage, which inactivates the target RNA.

(see Figure 35-7). Changes in the DNA sequence should be reflected in a change in the mRNA sequence and, depending on codon usage, in protein sequence. However, exceptions to this dogma have been recently documented. Coding information can be changed at the mRNA level by **RNA editing**. In such cases, the coding sequence of the mRNA differs from that in the cognate DNA. An example is the apolipoprotein B (*apoB*) gene and mRNA. In liver, the single *apoB* gene is transcribed into an mRNA that directs the synthesis of a 100-kDa

protein, apoB100. In the intestine, the same gene directs the synthesis of the identical mRNA primary transcript; however, a cytidine deaminase converts a CAA codon in the mRNA to UAA at a single specific site. Rather than encoding glutamine, this codon becomes a termination signal (see Table 37-1), and hence production of a truncated 48-kDa protein (apoB48) results. ApoB100 and apoB48 have different functions in the two organs. A growing number of other examples include a glutamine to arginine change in the glutamate receptor and

several changes in trypanosome mitochondrial mRNAs, generally involving the addition or deletion of uridine. The exact extent of RNA editing is unknown, but current estimates suggest that perhaps 0.01% of mRNAs are edited in this fashion. Recently, editing of miRNAs has been described suggesting that these two forms of posttranscriptional control mechanisms could cooperatively contribute to gene regulation.

Transfer RNA Is Extensively Processed & Modified

As described in Chapters 34 & 37, the tRNA molecules serve as adapter molecules for the translation of mRNA into protein sequences. The tRNAs contain many modifications of the standard bases A, U, G, and C, including methylation, reduction, deamination, and rearranged glycosidic bonds. Further post-transcriptional modification of the tRNA molecules includes nucleotide alkylations and the attachment of the characteristic CpCpA_{OH} terminal at the 3' end of the molecule by the enzyme nucleotidyl transferase. The 3' OH of the A ribose is the point of attachment for the specific amino acid that is to enter into the polymerization reaction of protein synthesis. The methylation of mammalian tRNA precursors probably occurs in the nucleus, whereas the cleavage and attachment of CpCpA_{OH} are cytoplasmic functions, since the terminal nucleotides turn over more rapidly than do the tRNA molecules themselves. Enzymes within the cytoplasm of mammalian cells are required for the attachment of amino acids to the CpCpA_{OH} residues (see Chapter 37).

RNA CAN ACT AS A CATALYST

In addition to the catalytic action served by the snRNAs in the formation of mRNA, several other enzymatic functions have been attributed to RNA. **Ribozymes** are RNA molecules with catalytic activity. These generally involve transesterification reactions, and most are concerned with RNA metabolism (splicing and endoribonuclease).

Recently, a rRNA component has been implicated in hydrolyzing an aminoacyl ester and thus to play a central role in peptide bond function (peptidyl transferases; see Chapter 37). These observations, made using RNA molecules derived from the organelles from plants, yeast, viruses, and higher eukaryotic cells, show that RNA can act as an enzyme, and have revolutionized thinking about enzyme action and the origin of life itself.

SUMMARY

- RNA is synthesized from a DNA template by the enzyme DNA-dependent RNA polymerase.
- While bacteria contain but a single RNA polymerase ($\beta\beta\alpha_2\sigma$) there are three distinct nuclear DNA-dependent RNA polymerases in mammals: RNA polymerases I, II, and III. These enzymes catalyze the transcription of rRNA (Pol I), mRNA/mi/siRNAs/lncRNAs (Pol II), and tRNA and 5S rRNA (Pol III) encoding genes.

- RNA polymerases interact with unique *cis*-active regions of genes, termed promoters, in order to form preinitiation complexes (PICs) capable of initiation. In eukaryotes, the process of pol II PIC formation requires, in addition to polymerase, multiple general transcription factors (GTFs), TFIIA, B, D, E, F, and H.
- Eukaryotic PIC formation can occur on accessible promoters either step-wise—by the sequential, ordered interactions of GTFs and RNA polymerase with DNA promoters—or in one step by the recognition of the promoter by a pre-formed GTF-RNA polymerase holoenzyme complex.
- Transcription exhibits three phases: initiation, elongation, and termination. All are dependent upon distinct DNA *cis*-elements and can be modulated by distinct *trans*-acting protein factors.
- The presence of nucleosomes can either enhance or occlude the binding of both transactors and the transcription machinery to their cognate DNA *cis*-elements, thereby inhibiting transcription.
- Most eukaryotic RNAs are synthesized as precursors that contain excess sequences which are removed prior to the generation of mature, functional RNA. These processing reactions provide additional potential steps for regulation of gene expression.
- Eukaryotic mRNA synthesis results in a pre-mRNA precursor that contains extensive amounts of excess RNA (introns) that must be precisely removed by RNA splicing to generate functional, translatable mRNA composed of exonic coding and 5' and 3' noncoding sequences.
- All steps—from changes in DNA template, sequence, and accessibility in chromatin to RNA stability and translatability—are subject to modulation and hence are potential control sites for eukaryotic gene regulation.

REFERENCES

- Bourbon H-M, Aguilera A, Ansari AZ, et al: A unified nomenclature for protein subunits of mediator complexes linking transcriptional regulators to RNA polymerase II. *Mol Cell* 2004;14:553-537.
- Buchan JR, Parker R: Eukaryotic stress granules: the ins and outs of translation. *Mol Cell* 2009;36:932-941.
- Decker KB, Hinton DM: Transcription regulation at the core: similarities among bacterial, archaeal, and eukaryotic RNA polymerases. *Annu Rev Microbiol* 2013;67:113-139.
- Elkon R, Ugalde AP, Agami R: Alternative cleavage and polyadenylation: extent, regulation and function. *Nat Rev Genet* 2013;14:496-506.
- Marcia M, Pyle AM: Visualizing group II intron catalysis through the stages of splicing. *Cell* 2012;151:497-507.
- Geisler S, Collier J: RNA in unexpected places: long non-coding RNA functions in diverse cellular contexts. *Nat Rev Mol Cell Biol* 2013;14:699-712.
- He Y, Fang J, Taatjes DJ, Nogales E: Structural visualization of key steps in human transcription initiation. *Nature* 2013;495:481-486.
- Hood JL, Emeson RB: Editing of neurotransmitter receptor and ion channel RNAs in the nervous system. *Curr Top Microbiol Immunol* 2012;353:61-90.
- Hsin JP, Manley JL: The RNA polymerase II CTD coordinates transcription and RNA processing. *Genes Dev* 2012;26:2119-2137.

- Kassube SA, Fang J, Grob P, Yakovchuk P, Goodrich JA, Nogales E: Structural insights into transcriptional repression by noncoding RNAs that bind to human Pol II. *J Mol Biol* 2013;425:3639-3648.
- Kawauchi J, Mischo H, Braglia P, et al: Budding yeast RNA polymerases I and II employ parallel mechanisms of transcriptional termination. *Genes Dev* 2008;22:1082-1092.
- Keaveney M, Struhl K: Activator-mediated recruitment of the RNA polymerase machinery is the predominant mechanism for transcriptional activation in yeast. *Mol Cell* 1998;1:917-924.
- Kornblihtt AR, Schor IE, Alló M, Dujardin G, Petrillo E, Muñoz MJ: Alternative splicing: a pivotal step between eukaryotic transcription and translation. *Nat Rev Mol Cell Biol* 2013; 14:153-165.
- Mapendano CK, Lykke-Andersen S, Kjems J, et al: Crosstalk between mRNA 3' end processing and transcription initiation. *Mol Cell* 2010;40:410-422.
- Mauger DM, Siegfried NA, Weeks KM: The genetic code as expressed through relationships between mRNA structure and protein function. *FEBS Lett* 2013 587:1180-1188.
- Murakami K, Elmlund H, Kalisman N, Bushnell DA, Adams CM, Azubel M, Elmlund D, Levi-Kalisman Y, Liu X, Gibbons BJ, Levitt M, Kornberg RD: Architecture of an RNA polymerase II transcription pre-initiation complex. *Science* 2013;342:1238724.
- Nechaev S, Adelman K: Pol II waiting in the starting gates: regulating the transition from transcription initiation into productive elongation. *Biochim Biophys Acta* 2011;1809:34-45.
- Ørom UA, Shiekhattar R: Long noncoding RNAs usher in a new era in the biology of enhancers. *Cell* 2013 154:1190-1193.
- Pawlicki JM, Steitz JA: Nuclear networking fashions pre-messenger RNA and primary microRNA transcripts for function. *Trends Cell Biol* 2010; 20:52-61.
- Proudfoot NJ: Ending the message: poly(A) signals then and now. *Genes Dev* 2011; 25:1770-1782.
- Reed R, Cheng H: TREX, SR proteins and export of mRNA. *Curr Opin Cell Biol* 2005;17:269-273.
- Rhee HS, Pugh BF: Genome-wide structure and organization of eukaryotic pre-initiation complexes. *Nature* 2012;483:295-301.
- Tian B, Manley JL: Alternative cleavage and polyadenylation: the long and short of it. *Trends Biochem Sci* 2013;38:312-320.
- West S, Proudfoot NJ, Dye MJ, et al: Molecular dissection of mammalian RNA polymerase II transcriptional termination. *Mol Cell* 2008;29:600-610.

Protein Synthesis & the Genetic Code

P. Anthony Weil, PhD

OBJECTIVES

After studying this chapter, you should be able to:

- Understand that the genetic code is a three-letter nucleotide code, which is encoded in the linear array of the exon DNA (composed of triplets of A, G, C, and T) of protein coding genes, and that this three-letter code is translated into mRNA (composed of triplets of A, G, C, and U) to specify the linear order of amino acid addition during protein synthesis via the process of translation.
- Appreciate that the universal genetic code is degenerate, unambiguous, nonoverlapping, and punctuation free.
- Explain that the genetic code is composed of 64 codons, 61 of which encode amino acids while 3 induce the termination of protein synthesis.
- Explain how the transfer RNAs (tRNAs) serve as the ultimate informational agents that decode the genetic code of mRNAs.
- Understand the mechanism of the energy-intensive process of protein synthesis that occurs on RNA-protein complexes termed ribosomes.
- Appreciate that protein synthesis, like DNA replication and transcription, is precisely controlled through the action of multiple accessory factors that are responsive to multiple extra- and intracellular regulatory signaling inputs.

BIOMEDICAL IMPORTANCE

The letters A, G, T, and C correspond to the nucleotides found in DNA. Within the protein-coding genes, these nucleotides are organized into three-letter code words called **codons**, and the collection of these codons makes up the **genetic code**. It was impossible to understand protein synthesis—or to explain mutations—before the genetic code was elucidated. The code provides a foundation for explaining the way in which protein defects may cause genetic disease and for the diagnosis and perhaps the treatment of these disorders. In addition, the pathophysiology of many viral infections is related to the ability of these infectious agents to disrupt host cell protein synthesis. Many antibacterial drugs are effective because they selectively disrupt protein synthesis in the invading bacterial cell but do not affect protein synthesis in eukaryotic cells.

GENETIC INFORMATION FLOWS FROM DNA TO RNA TO PROTEIN

The genetic information within the nucleotide sequence of DNA is transcribed in the nucleus into the specific nucleotide sequence of an RNA molecule. The sequence of nucleotides in the RNA transcript is complementary to the nucleotide sequence of the template strand of its gene in accordance with the base-pairing rules. Several different classes of RNA combine to direct the synthesis of proteins.

In prokaryotes there is a linear correspondence between the gene, the **messenger RNA (mRNA)** transcribed from the gene, and the polypeptide product. The situation is more complicated in higher eukaryotic cells, in which the primary transcript is much larger than the mature mRNA. The large mRNA precursors contain coding regions (**exons**) that will form the mature mRNA and long intervening sequences (**introns**)

that separate the exons. The mRNA is processed within the nucleus, and the introns, which make up much more of this RNA than the exons, are removed. Exons are spliced together to form mature mRNA, which is transported to the cytoplasm, where it is translated into protein.

The cell must possess the machinery necessary to translate information accurately and efficiently from the nucleotide sequence of an mRNA into the sequence of amino acids of the corresponding specific protein. Clarification of our understanding of this process, which is termed **translation**, awaited deciphering of the genetic code. It was realized early that mRNA molecules themselves have no affinity for amino acids and, therefore, that the translation of the information in the mRNA nucleotide sequence into the amino acid sequence of a protein requires an intermediate adapter molecule. This adapter molecule must recognize a specific nucleotide sequence on the one hand as well as a specific amino acid on the other. With such an adapter molecule, the cell can direct a specific amino acid into the proper sequential position of a protein during its synthesis as dictated by the nucleotide sequence of the specific mRNA. In fact, the functional groups of the amino acids do not themselves actually come into contact with the mRNA template.

THE NUCLEOTIDE SEQUENCE OF AN mRNA MOLECULE CONTAINS A SERIES OF CODONS THAT SPECIFY THE AMINO ACID SEQUENCE OF THE ENCODED PROTEIN

Twenty different amino acids are required for the synthesis of the cellular complement of proteins; thus, there must be at least 20 distinct codons that make up the genetic code. Since there are only four different nucleotides in mRNA, each codon must consist of more than a single purine or pyrimidine nucleotide. Codons consisting of two nucleotides each could provide for only $16(4^2)$ -distinct codons, whereas codons of three nucleotides could provide $64(4^3)$ -specific codons.

It is now known that each codon consists of a sequence of three nucleotides; that is, **it is a triplet code** (see Table 37–1). The initial deciphering of the **genetic code** depended heavily on in vitro synthesis of nucleotide polymers, particularly triplets in repeated sequence. These synthetic triplet ribonucleotides were used as mRNAs to program protein synthesis in the test tube, and allowed investigators to deduce the genetic code.

THE GENETIC CODE IS DEGENERATE, UNAMBIGUOUS, NONOVERLAPPING, WITHOUT PUNCTUATION, & UNIVERSAL

Three of the 64 possible codons do not code for specific amino acids; these have been termed **nonsense codons**. These nonsense codons are utilized in the cell as **termination signals**;

TABLE 37–1 The Genetic Code^a (Codon Assignments in Mammalian Messenger RNAs)

First Nucleotide	Second Nucleotide				Third Nucleotide
	U	C	A	G	
U	Phe	Ser	Tyr	Cys	U
	Phe	Ser	Tyr	Cys	C
	Leu	Ser	Term	Term ^b	A
	Leu	Ser	Term	Trp	G
C	Leu	Pro	His	Arg	U
	Leu	Pro	His	Arg	C
	Leu	Pro	Gln	Arg	A
	Leu	Pro	Gln	Arg	G
A	Ile	Thr	Asn	Ser	U
	Ile	Thr	Asn	Ser	C
	Ile ^a	Thr	Lys	Arg ^b	A
	Met	Thr	Lys	Arg ^b	G
G	Val	Ala	Asp	Gly	U
	Val	Ala	Asp	Gly	C
	Val	Ala	Glu	Gly	A
	Val	Ala	Glu	Gly	G

^aThe terms first, second, and third nucleotide refer to the individual nucleotides of a triplet codon read 5'-3', left to right. A, adenine nucleotide; C, cytosine nucleotide; G, guanine nucleotide; Term, chain terminator codon; U, uridine nucleotide. AUG, which codes for Met, serves as the initiator codon in mammalian cells and also encodes for internal methionines in a protein. (Abbreviations of amino acids are explained in Chapter 3.)

^bIn mammalian mitochondria, AUA codes for Met and UGA for Trp, and AGA and AGG serve as chain terminators.

they specify where the polymerization of amino acids into a protein molecule is to stop. **The remaining 61 codons code for the 20 naturally occurring amino acids** (Table 37–1). Thus, there is **“degeneracy”** in the genetic code—that is, multiple codons decode the same amino acid. Some amino acids are encoded by several codons; for example, six different codons, UCU, UCC, UCA, UCG, AGU, and AGC all specify serine. Other amino acids, such as methionine and tryptophan, have a single codon. In general, the third nucleotide in a codon is less important than the first two in determining the specific amino acid to be incorporated, and this accounts for most of the degeneracy of the code. However, for any specific codon, only a single amino acid is specified; with rare exceptions, the genetic code is **unambiguous**—that is, given a specific codon, only a single amino acid is indicated. **The distinction between ambiguity and degeneracy is an important concept.**

The unambiguous but degenerate code can be explained in molecular terms. The recognition of specific codons in the mRNA by the tRNA adapter molecules is dependent upon the tRNA **anticodon region** and specific base pairing rules that dictate tRNA-mRNA codon binding. Each tRNA molecule contains a specific sequence, complementary to a

codon, which is termed its anticodon. For a given codon in the mRNA, only a single species of tRNA molecule possesses the proper anticodon. Since each tRNA molecule can be charged with only one specific amino acid, each codon therefore specifies only one amino acid. However, some tRNA molecules can utilize the anticodon to recognize more than one codon. **With few exceptions, given a specific codon, only a specific amino acid will be incorporated—although, given a specific amino acid, more than one codon may be used.**

As discussed below, the reading of the genetic code during the process of protein synthesis does not involve any overlap of codons. **Thus, the genetic code is nonoverlapping.** Furthermore, once the reading is commenced at a specific start codon, there is **no punctuation** between codons, and the message is read in a continuing sequence of nucleotide triplets until a translation stop codon is reached.

Until recently, the genetic code was thought to be universal. It has now been shown that the set of tRNA molecules in mitochondria (which contain their own separate and distinct set of translation machinery) from lower and higher eukaryotes, including humans, reads four codons differently from the tRNA molecules in the cytoplasm of even the same cells. As noted in Table 37-1, in mammalian mitochondria the codon AUA is read as Met, and UGA codes for Trp. In addition, in mitochondria, the codons AGA and AGG are read as stop or chain terminator codons rather than as Arg. As a result of these organelle-specific changes in genetic code, mitochondria require only 22 tRNA molecules to read their genetic code, whereas the cytoplasmic translation system possesses a full complement of 31 tRNA species. These exceptions noted, **the genetic code is universal.** The frequency of use of each amino acid codon varies considerably between species and among different tissues within a species. The specific tRNA levels generally mirror these codon usage biases. Thus, a particular abundantly used codon is decoded by a similarly abundant-specific tRNA which recognizes that particular codon. Tables of **codon usage** are quite accurate now that many genomes have been sequenced and such information is vital for large-scale production of proteins for therapeutic

TABLE 37-2 Features of the Genetic Code

• Degenerate
• Unambiguous
• Nonoverlapping
• Not punctuated
• Universal

purposes (ie, insulin, erythropoietin). Such proteins are often produced in nonhuman cells using recombinant DNA technology (see Chapter 39). The main features of the genetic code are listed in Table 37-2.

AT LEAST ONE SPECIES OF TRANSFER RNA (tRNA) EXISTS FOR EACH OF THE 20 AMINO ACIDS

tRNA molecules have extraordinarily similar functions and three-dimensional structures. The adapter function of the tRNA molecules requires the charging of each specific tRNA with its specific amino acid. Since there is no affinity of nucleic acids for specific functional groups of amino acids, this recognition must be carried out by a protein molecule capable of recognizing both a specific tRNA molecule and a specific amino acid. At least 20-specific enzymes are required for these specific recognition functions and for the proper attachment of the 20 amino acids to specific tRNA molecules. This energy requiring process of **recognition and attachment (charging)** proceeds in two steps and is catalyzed by one enzyme for each of the 20 amino acids. These enzymes are termed **aminoacyl-tRNA synthetases**. They form an activated intermediate of aminoacyl-AMP-enzyme complex (Figure 37-1). The specific aminoacyl-AMP-enzyme complex then recognizes a

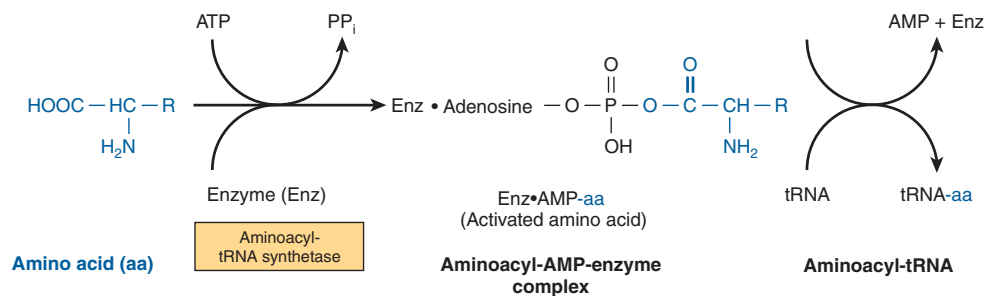

FIGURE 37-1 Formation of aminoacyl-tRNA. A two-step reaction, involving the enzyme aminoacyl-tRNA synthetase, results in the formation of aminoacyl-tRNA. The first reaction involves the formation of an AMP-amino acid-enzyme complex. This activated amino acid is next transferred to the corresponding tRNA molecule. The AMP and enzyme are released, and the latter can be reutilized. The charging reactions have an error rate (ie, esterifying the incorrect amino acid on tRNA_x) of less than 10^{-4} .

specific tRNA to which it attaches the aminoacyl moiety at the 3'-hydroxyl adenosyl terminal. The charging reactions have an error rate of less than 10^{-4} and so are quite accurate. The amino acid remains attached to its specific tRNA in an ester linkage until it is polymerized at a specific position in the fabrication of a polypeptide precursor of a protein molecule.

The regions of the tRNA molecule referred to in Chapter 34 (and illustrated in Figure 34–11) now become important. The ribothymidine pseudouridine cytidine (T Ψ C) arm is involved in binding of the aminoacyl-tRNA to the ribosomal surface at the site of protein synthesis. The D arm is one of the sites important for the proper recognition of a given tRNA species by its proper aminoacyl-tRNA synthetase. The acceptor arm, located at the 3'-hydroxyl adenosyl terminal, is the site of attachment of the specific amino acid.

The anticodon region (arm) consists of seven nucleotides, and it recognizes the three-letter codon in mRNA (Figure 37–2). The sequence read from the 3' to 5' direction in that anticodon loop consists of a variable base (N)—modified purine (Pu*)—XYZ (the anticodon)—pyrimidine (Py)—pyrimidine (Py)—5'. Note that this direction of reading the anticodon is 3'-5', whereas the genetic code in Table 37–1 is read 5'-3', since **the codon and the anticodon loop of the mRNA and tRNA molecules, respectively, are antiparallel in their complementarity** just like all other intermolecular interactions between nucleic acid strands.

The degeneracy of the genetic code resides mostly in the last nucleotide of the codon triplet, suggesting that the base pairing between this last nucleotide and the corresponding nucleotide of the anticodon is not strictly by the Watson-Crick rule. This is called **wobble**; the pairing of the codon and anticodon

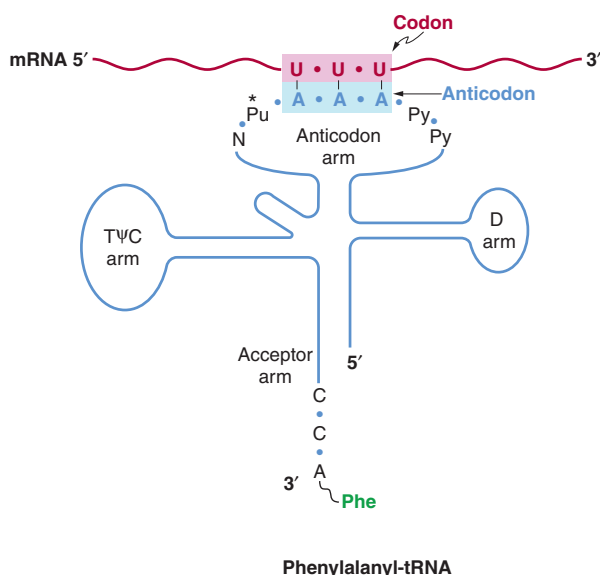

FIGURE 37–2 Recognition of the codon by the anticodon. One of the codons for phenylalanine is UUU. tRNA charged with phenylalanine (Phe) has the complementary sequence AAA; hence, it forms a base-pair complex with the codon. The anticodon region (arm) typically consists of a sequence of seven nucleotides: variable (N), modified purine (Pu*), X, Y, Z (here, A A A), and two pyrimidines (Py) in the 3'-5' direction.

can “wobble” at this specific nucleotide-to-nucleotide pairing site. For example, the two codons for arginine, AGA and AGG, can bind to the same anticodon having a uracil at its 5' end (UCU). Similarly, three codons for glycine—GGU, GGC, and GGA—can form a base pair from one anticodon, 3' CCI 5' (ie, I, inosine, can base pair with U, C, and A). Inosine is generated by deamination of adenine (see Figure 33–2 for structure).

MUTATIONS RESULT WHEN CHANGES OCCUR IN THE NUCLEOTIDE SEQUENCE

Although the initial change may not occur in the template strand of the double-stranded DNA molecule for that gene, after replication, daughter DNA molecules with mutations in the template strand will segregate and appear in the population of organisms.

Some Mutations Occur by Base Substitution

Single-base changes (**point mutations**) may be **transitions** or **transversions**. In the former, a given pyrimidine is changed to the other pyrimidine or a given purine is changed to the other purine. Transversions are changes from a purine to either of the two pyrimidines or the change of a pyrimidine into either of the two purines, as shown in Figure 37–3.

When the nucleotide sequence of a protein-coding gene containing the mutation is transcribed into an mRNA molecule, then the RNA molecule will of course possess the base change at the corresponding location.

Single-base changes in the mRNA may have one of several effects when translated into protein:

1. There may be no detectable effect because of the degeneracy of the code; such mutations are often referred to as **silent mutations**. This would be most likely if the changed base in the mRNA molecule were to be at the third nucleotide of a codon. Because of wobble, the translation of a codon is least sensitive to a change at the third position.
2. A **missense effect** will occur when a different amino acid is incorporated at the corresponding site in the protein molecule. This mistaken amino acid—or missense, depending upon its location in the specific protein—might be acceptable, partially acceptable, or unacceptable to the function of that protein molecule. From a careful examination of

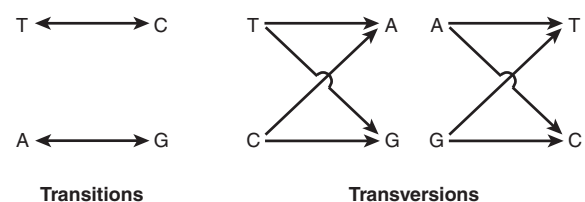

FIGURE 37–3 Diagrammatic representation of transition mutations and transversion mutations.

the genetic code, one can conclude that most single-base changes would result in the replacement of one amino acid by another with rather similar functional groups. This is an effective “buffering” mechanism to avoid drastic change in the physical properties of a protein molecule. If an acceptable missense effect occurs, the resulting protein molecule may not be distinguishable from the normal one. A partially acceptable missense will result in a protein molecule with partial but abnormal function. If an unacceptable missense effect occurs, then the protein molecule will not be capable of functioning normally.

3. A **nonsense** codon may appear that would then result in the **premature termination** of translation and the production of only a fragment of the intended protein molecule. The probability is high that a prematurely terminated protein molecule or peptide fragment will not function in its normal role. Examples of the different types of mutations, and their effects on the coding potential of mRNA are presented in **Figures 37–4** and **37–5**.

Frameshift Mutations Result From Deletion or Insertion of Nucleotides in DNA That Generates Altered mRNAs

The deletion of a single nucleotide from the coding strand of a gene results in an altered reading frame in the mRNA. The machinery translating the mRNA does not recognize that a base was missing, since there is no punctuation in the reading

of codons. Thus, a major alteration in the sequence of polymerized amino acids, as depicted in example 1, Figure 37–5, results. Altering the reading frame results in a garbled translation of the mRNA distal to the single nucleotide deletion. Not only is the sequence of amino acids distal to this deletion garbled, but reading of the message can also result in the appearance of a nonsense codon and thus the production of a polypeptide both garbled and prematurely terminated (example 3, Figure 37–5).

If three nucleotides or a multiple of three nucleotides are deleted from a coding region, translation of the corresponding mRNA will generate a protein that is missing the corresponding number of amino acids (example 2, Figure 37–5). Because the reading frame is a triplet, the reading phase will not be disturbed for those codons distal to the deletion. If, however, deletion of one or two nucleotides occurs just prior to or within the normal termination codon (nonsense codon), the reading of the normal termination signal is disturbed. Such a deletion might result in reading through the now “mutated” termination signal until another nonsense codon is encountered (example 1, Figure 37–5).

Insertions of one or two or nonmultiples of three nucleotides into a gene result in an mRNA in which the reading frame is distorted upon translation, and the same effects that occur with deletions are reflected in the mRNA translation. This may result in garbled amino acid sequences distal to the insertion and the generation of a **nonsense codon** at or distal to the insertion, or perhaps reading through the normal termination codon. Following a deletion in a gene, an insertion (or vice versa) can

	Protein molecule	Amino acid	Codons
Acceptable missense	Hb A, β chain ↓ Hb Hikari, β chain	61 Lysine ↓ Asparagine	AAA or AAG ↓ ↓ AAU or AAC
Partially acceptable missense	Hb A, β chain ↓ Hb S, β chain	6 Glutamate ↓ Valine	GAA or GAG ↓ ↓ GUA or GUG
Unacceptable missense	Hb A, α chain ↓ Hb M (Boston), α chain	58 Histidine ↓ Tyrosine	CAU or CAC ↓ ↓ UAU or UAC

FIGURE 37–4 Examples of three types of missense mutations resulting in abnormal hemoglobin chains. The amino acid alterations and possible alterations in the respective codons are indicated. The hemoglobin Hikari β -chain mutation has apparently normal physiologic properties but is electrophoretically altered. Hemoglobin S has a β -chain mutation and partial function; hemoglobin S binds oxygen but precipitates when deoxygenated; this causes red blood cells to sickle, and represents the cellular and molecular basis of sickle cell disease (see Figure 6–13). Hemoglobin M Boston, an α -chain mutation, permits the oxidation of the heme ferrous iron to the ferric state and so will not bind oxygen at all.

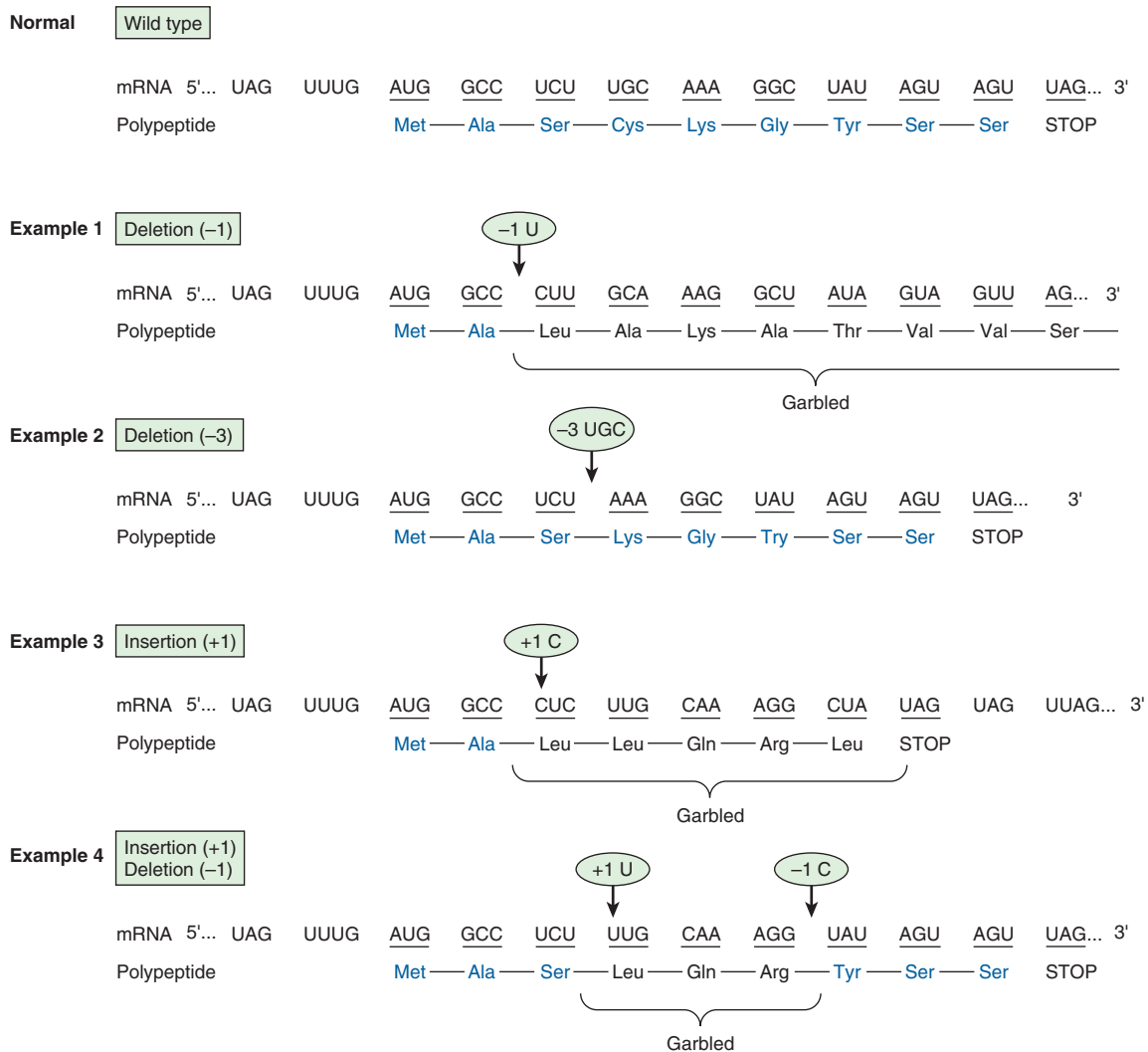

FIGURE 37-5 Examples of the effects of deletions and insertions in a gene on the sequence of the mRNA transcript and of the polypeptide chain translated therefrom. The arrows indicate the sites of deletions or insertions, and the numbers in the ovals indicate the number of nucleotide residues deleted or inserted. Colored type indicates amino acids in correct order.

reestablish the proper reading frame (example 4, Figure 37-5). The corresponding mRNA, when translated, would contain a garbled amino acid sequence between the insertion and deletion. Beyond the reestablishment of the reading frame, the amino acid sequence would be correct. One can imagine that different combinations of deletions, of insertions, or of both would result in formation of a protein wherein a portion is abnormal, but this portion is surrounded by the normal amino acid sequences. Such phenomena have been demonstrated convincingly in a number of human diseases.

Suppressor Mutations Can Counteract Some of the Effects of Missense, Nonsense, & Frameshift Mutations

The above discussion of the altered protein products of gene mutations is based on the presence of normally functioning tRNA molecules. However, in prokaryotic and lower eukaryotic

organisms, abnormally functioning tRNA molecules have been discovered that are themselves the results of mutations. Some of these abnormal tRNA molecules are capable of binding to and decoding altered codons, thereby suppressing the effects of mutations in distinct-mutated mRNA-encoding structural genes. These **suppressor tRNA molecules**, usually formed as a result of alterations in their anticodon regions, are capable of suppressing certain missense mutations, nonsense mutations, and frameshift mutations. However, since the suppressor tRNA molecules are not capable of distinguishing between a normal codon and one resulting from a gene mutation, their presence in the microbial cell usually results in decreased viability. For instance, the nonsense suppressor tRNA molecules can suppress the normal termination signals to allow a read-through when it is not desirable. Frameshift suppressor tRNA molecules may read a normal codon plus a component of a juxtaposed codon to provide a frameshift, also when it is not desirable. Suppressor tRNA molecules may exist

in mammalian cells, since read-through of translation has on occasion been observed. In the laboratory context such suppressor tRNAs, coupled with mutated variants of aminoacyl tRNA synthetases, can be utilized to incorporate unnatural amino acids into defined locations within altered genes that carry engineered nonsense mutations. The resulting labeled proteins can be used for in vivo and in vitro cross-linking and biophysical studies. This new tool adds significantly to biologists interested in studying the mechanisms of a wide range of biological processes.

LIKE TRANSCRIPTION, PROTEIN SYNTHESIS CAN BE DESCRIBED IN THREE PHASES: INITIATION, ELONGATION, & TERMINATION

The general structural characteristics of ribosomes and their self-assembly process are discussed in Chapter 34. These particulate entities serve as the machinery on which the mRNA nucleotide sequence is translated into the sequence of amino acids of the specified protein. The translation of the mRNA commences near its 5' end with the formation of the corresponding amino terminus of the protein molecule. The message is decoded from 5' to 3', concluding with the formation of the carboxyl terminus of the protein. Again, the concept of **polarity** is apparent. As described in Chapter 36, the transcription of a gene into the corresponding mRNA or its precursor first forms the 5' end of the RNA molecule. In prokaryotes, this allows for the beginning of mRNA translation before the transcription of the gene is completed. In eukaryotic organisms, the process of transcription is a nuclear one, while mRNA translation occurs in the cytoplasm, precluding simultaneous transcription and translation in eukaryotic organisms and enabling the processing necessary to generate mature mRNA from the primary transcript.

Initiation Involves Several Protein–RNA Complexes

Initiation of protein synthesis requires that an mRNA molecule be selected for translation by a ribosome (**Figure 37–6**). Once the mRNA binds to the ribosome, the ribosome must locate the initiation codon thereby setting the correct reading frame on the mRNA, and translation begins. This process involves tRNA, rRNA, mRNA, and at least **10 eukaryotic initiation factors (eIFs)**, some of which have multiple (three to eight) subunits. Also involved are GTP, ATP, and amino acids. Initiation can be divided into four steps: (1) dissociation of the ribosome into its 40S and 60S subunits; (2) binding of a ternary complex consisting of the **initiator methionyl-tRNA, (met-tRNAⁱ)**, GTP, and **eIF-2** to the 40S ribosome to form the **43S preinitiation complex**; (3) binding of mRNA to the 40S preinitiation complex to form the **48S initiation complex**; and (4) combination of the 48S initiation complex with the 60S ribosomal subunit to form the **80S initiation complex**.

Ribosomal Dissociation

Two initiation factors, **eIF-3** and **eIF-1A**, bind to the newly dissociated 40S ribosomal subunit. This delays its reassociation with the 60S subunit and allows other translation initiation factors to associate with the 40S subunit.

Formation of the 43S Preinitiation Complex

The first step in this process involves the binding of GTP by eIF-2. This binary complex then binds to met tRNAⁱ, a tRNA specifically involved in binding to the initiation codon AUG. (It is important to note that there are two tRNAs for methionine. One specifies methionine for the initiator codon, the other for internal methionines. Each has a unique nucleotide sequence; both are aminoacylated by the same methionyl-tRNA synthetase.) The GTP-eIF-2-tRNAⁱ ternary complex binds to the 40S ribosomal subunit to form the 43S preinitiation complex, which is subsequently stabilized by association with eIF-3 and eIF-1A.

eIF-2 is one of two control points for protein synthesis initiation in eukaryotic cells. eIF-2 consists of α , β , and γ subunits. **eIF-2 α is phosphorylated** (on serine 51) by at least **four different protein kinases (HCR, PKR, PERK, and GCN2)** that are activated when a cell is under stress and when the energy expenditure required for protein synthesis would be deleterious. Such conditions include amino acid or glucose starvation, virus infection, intracellular presence of large quantities of misfolded proteins, serum deprivation, hyperosmolality, and heat shock. PKR is particularly interesting in this regard. This kinase is activated by viruses and provides a host defense mechanism that decreases protein synthesis, including viral protein synthesis, thereby inhibiting viral replication. Phosphorylated eIF-2 α binds tightly to and inactivates the GTP-GDP recycling protein eIF-2B. Thus preventing formation of the 43S preinitiation complex and blocking protein synthesis.

Formation of the 48S Initiation Complex

As described in Chapter 36 the 5' termini of mRNA molecules in eukaryotic cells are "capped." The 7^{me}G-cap facilitates the binding of mRNA to the 43S preinitiation complex. A **cap-binding protein complex, eIF-4F (4F)**, which consists of **eIF-4E (4E)** and the **eIF-4G (4G)-eIF-4A (4A) complex**, binds to the cap through the 4E protein. Then **eIF-4B (4B)** binds and reduces the complex secondary structure of the 5' end of the mRNA through its ATP-dependent helicase activity. The association of mRNA with the 43S preinitiation complex to form the 48S initiation complex requires ATP hydrolysis. eIF-3 is a key protein because it binds with high affinity to the 4G component of 4F, and it links this complex to the 40S ribosomal subunit. Following association of the 43S preinitiation complex with the mRNA cap, and reduction ("melting") of the secondary structure near the 5' end of the mRNA through the action of the 4B helicase and ATP, the complex translocates 5' → 3' and scans the mRNA for a suitable initiation codon. Generally, this is the 5'-most AUG, but the precise initiation

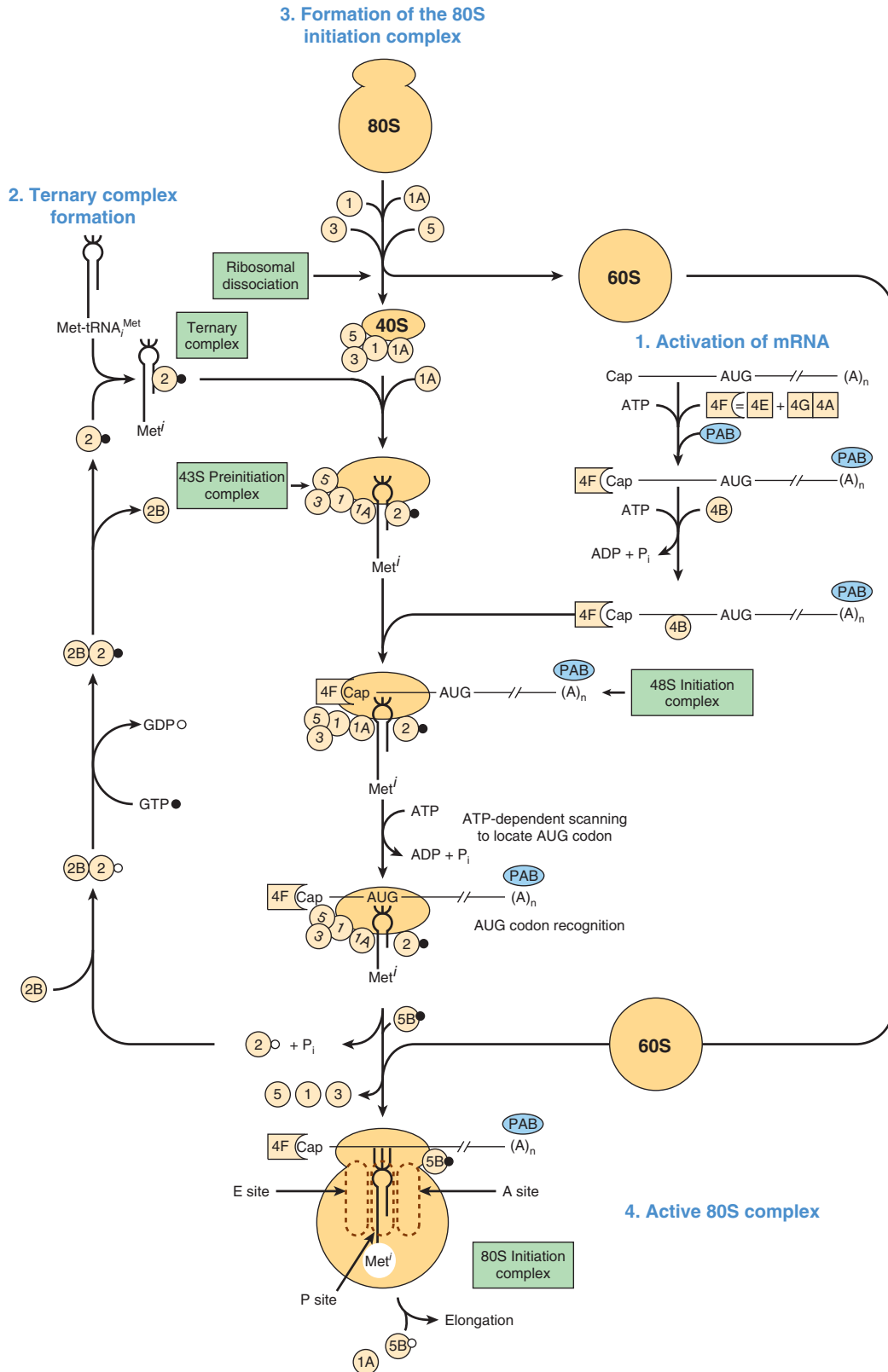

FIGURE 37-6 Diagrammatic representation of the initiation phase of protein synthesis on an eukaryotic mRNA. Eukaryotic mRNAs contain a 5' ^{7m}G-cap (Cap) and 3' poly(A) terminal [(A)_n] as shown. Translation preinitiation complex formation proceeds in several steps: (1) activation of mRNA (**right**); (2) formation of the ternary complex consisting of met-tRNAⁱ, initiation factor eIF-2, and GTP (**left**); (3) scanning in the 43S complex to locate the AUG initiator coding, forming the 48S initiation complex (**center**); and (4) formation of the active 80S initiation complex (**bottom, center**). (See text for details.) (GTP, ●; GDP, ○.) The various initiation factors appear in abbreviated form as circles or squares, for example, eIF-3, (③), eIF-4F, (4F), (4F). 4•F is a complex consisting of 4E and 4A bound to 4G (see Figure 37-7). The poly A binding protein, which interacts with the mRNA 3'-poly A tail, is abbreviated PAB. This collection of protein factors and the 40S ribosomal subunit comprise the 43S preinitiation complex, which after binding to mRNA, forms the 48S preinitiation complex.

codon is determined by so-called **Kozak consensus sequences** that surround the **AUG** initiation codon:



Most preferred is the presence of a purine (Pu) at positions -3 and a G at position $+4$.

Role of the Poly(A) Tail in Initiation

Biochemical and genetic experiments in yeast have revealed that the 3' poly(A) tail and the **poly A binding protein, PAB1**, are both required for efficient initiation of protein synthesis. Further studies showed that the poly(A) tail stimulates recruitment of the 40S ribosomal subunit to the mRNA through a complex set of interactions. PAB (**Figure 37-7**) bound to the poly(A) tail, interacts with eIF-4G, and 4E subunits of cap-bound eIF-4F to form a circular structure that helps direct the 40S ribosomal subunit to the 5' end of the mRNA and also likely stabilizes mRNAs from exonucleolytic degradation. This helps explain how the cap and poly(A) tail structures have a synergistic effect on protein synthesis. Indeed, differential protein-protein interactions between general and specific mRNA translational repressors and eIF-4E result in m⁷G Cap-dependent translation control (**Figure 37-8**).

Formation of the 80S Initiation Complex

The binding of the 60S ribosomal subunit to the 48S initiation complex involves hydrolysis of the GTP bound to eIF-2 by eIF-5. This reaction results in release of the initiation factors bound to the 48S initiation complex (these factors then are recycled) and the rapid association of the 40S and 60S subunits to form the 80S ribosome. At this point, the met-tRNAⁱ is on the P site of the ribosome, ready for the elongation cycle to commence.

The Regulation of eIF-4E Controls the Rate of Initiation

The 4F complex is particularly important in controlling the rate of protein translation. As described above, 4F is a complex consisting of 4E, which binds to the m⁷G cap structure at the 5' end of the mRNA, and 4G, which serves as a scaffolding protein. In addition to binding 4E, 4G binds to eIF-3, which links the complex to the 40S ribosomal subunit. It also binds 4A and 4B, the ATPase-helicase complex that helps unwind the RNA (**Figure 37-8**).

4E is responsible for recognition of the mRNA cap structure, a rate-limiting step in translation. This process is further regulated by phosphorylation. Insulin and mitogenic growth

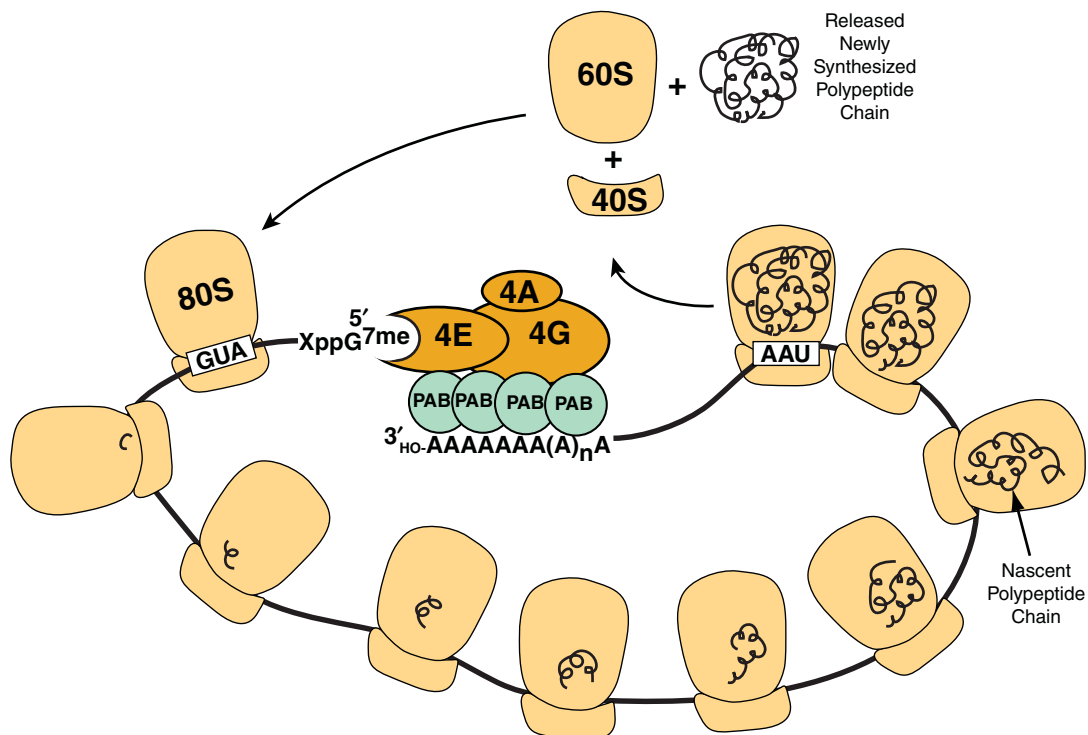

FIGURE 37-7 Schematic illustrating the circularization of mRNA through protein-protein interactions between ^{7me}G cap-bound eIF4F and poly A tail-bound poly A binding protein. eIF4F, composed of eIF4A, 4E, and 4G subunits binds the mRNA 5'-^{7me}G "Cap" (^{7me}GpppX-) upstream of the translation initiation codon (AUG) with high affinity. The eIF4G subunit of the complex also binds poly A binding protein (PAB) with high affinity. Since PAB is bound tightly to the mRNA 3'-poly A tail (5'-(X)_nA(A)_nAAAAAAAA_{OH} 3'), circularization results. Shown are multiple 80S ribosomes that are in the process of translating the circularized mRNA into protein (black curlicues), forming a polysome. Upon encountering a termination codon (here UAA), translation termination occurs leading to release of the newly translated protein and dissociation of the 80S ribosome into 60S, 40S subunits. Dissociated ribosomal subunits can recycle through another round of translation (see **Figure 37-6**).

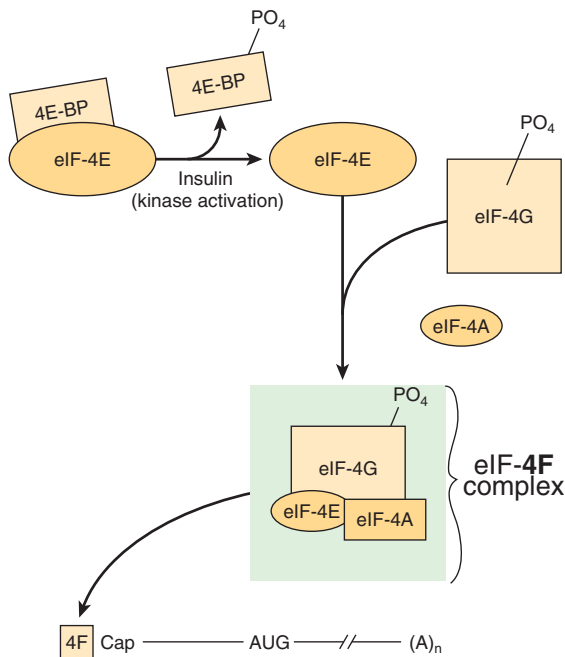

FIGURE 37-8 Activation of eIF-4E by insulin and formation of the cap binding eIF-4F complex. The 4F-cap mRNA complex is depicted as in Figures 37-6 and 37-7. The 4F complex consists of eIF-4E (4E), eIF-4A, and eIF-4G. 4E is inactive when bound by one of a family of binding proteins (4E-BPs). Insulin and mitogenic growth polypeptides, or growth factors (eg, IGF-1, PDGF, interleukin-2, and angiotensin II) activate the PI3 kinase/AKT kinase pathways, which activate the mTOR kinase, and results in the phosphorylation of 4E-BP (see Figure 42-8). Phosphorylated 4E-BP dissociates from 4E, and the latter is then able to form the 4F complex and bind to the mRNA cap. These growth polypeptides also induce phosphorylation of 4G itself by the mTOR and MAP kinase pathways. Phosphorylated 4F binds much more avidly to the cap than does nonphosphorylated 4F, which stimulates 48S initiation complex formation and hence translation.

factors result in the phosphorylation of 4E on Ser209 (or Thr210). Phosphorylated 4E binds to the cap much more avidly than does the nonphosphorylated form, thus enhancing the rate of initiation. Components of the MAP kinase, PI3K, mTOR, RAS, and S6 kinases pathways (see Figure 42-8) can all, under appropriate conditions, be involved in these regulatory phosphorylation reactions.

The activity of 4E is modulated in a second way, and this also involves phosphorylation; a set of proteins bind to and inactivate 4E. These proteins include **4E-BP1 (BP1)**, also known as **PHAS-1**) and the closely related proteins **4E-BP2** and **4E-BP3**. BP1 binds with high affinity to 4E. The [4E]•[BP1] association prevents 4E from binding to 4G (to form 4F). Since this interaction is essential for the binding of 4F to the ribosomal 40S subunit and for correctly positioning it on the capped mRNA, BP-1 effectively inhibits translation initiation.

Insulin and other growth factors result in the phosphorylation of BP-1 at seven unique sites. Phosphorylation of BP-1 results in its dissociation from 4E, and it cannot rebind until critical sites are dephosphorylated. These effects on the activation of 4E explain in part how insulin causes a marked

post-transcriptional increase of protein synthesis in liver, adipose, and muscle tissue.

Elongation Is Also a Multistep, Accessory Factor-Facilitated Process

Elongation is a cyclic process on the ribosome in which one amino acid at a time is added to the nascent peptide chain (Figure 37-9). The peptide sequence is determined by the order of the codons in the mRNA. Elongation involves several steps catalyzed by proteins called **elongation factors (EFs)**. These steps are (1) binding of aminoacyl-tRNA to the A site, (2) peptide bond formation, (3) translocation of the ribosome on the mRNA, and (4) expulsion of the deacylated tRNA from the P- and E-sites.

Binding of Aminoacyl-tRNA to the A Site

In the complete 80S ribosome formed during the process of initiation, both the **A site (aminoacyl or acceptor site)** and **E site (deacylated tRNA exit site)** are free. The binding of the appropriate aminoacyl-tRNA in the A site requires proper codon recognition. **Elongation factor 1A (EF1A)** forms a ternary complex with GTP and the entering aminoacyl-tRNA (Figure 37-9). This complex then allows the correct aminoacyl-tRNA to enter the A site with the release of EF1A•GDP and phosphate. GTP hydrolysis is catalyzed by an active site on the ribosome; hydrolysis induces a conformational change in the ribosome concomitantly increasing affinity for the tRNA. As shown in Figure 37-9, EF1A-GDP then recycles to EF1A-GTP with the aid of other soluble protein factors and GTP.

Peptide Bond Formation

The α -amino group of the new aminoacyl-tRNA in the A site carries out a nucleophilic attack on the esterified carboxyl group of the **peptidyl-tRNA** occupying the **P site (peptidyl or polypeptide site)**. At initiation, this site is occupied by the initiator met-tRNAⁱ. This reaction is catalyzed by a **peptidyl transferase**, a component of the 28S RNA of the 60S ribosomal subunit. This is another example of ribozyme activity and indicates an important—and previously unsuspected—direct role for RNA in protein synthesis (Table 37-3). Because the amino acid on the aminoacyl-tRNA is already “activated,” no further energy source is required for this reaction. The reaction results in attachment of the growing peptide chain to the tRNA in the A site.

Translocation

The now deacylated tRNA is attached by its anticodon to the P site at one end and by the open CCA tail to the E site on the large ribosomal subunit (middle portion of Figure 37-9). At this point, **elongation factor 2 (EF2)** binds to and displaces the peptidyl tRNA from the A site to the P site. In turn, the deacylated tRNA is on the E site, from which it leaves the ribosome. The EF2-GTP complex is hydrolyzed to EF2-GDP, effectively moving the mRNA forward by one codon and leaving the A site open for occupancy by another ternary complex of amino acid tRNA-EF1A-GTP and another cycle of elongation.

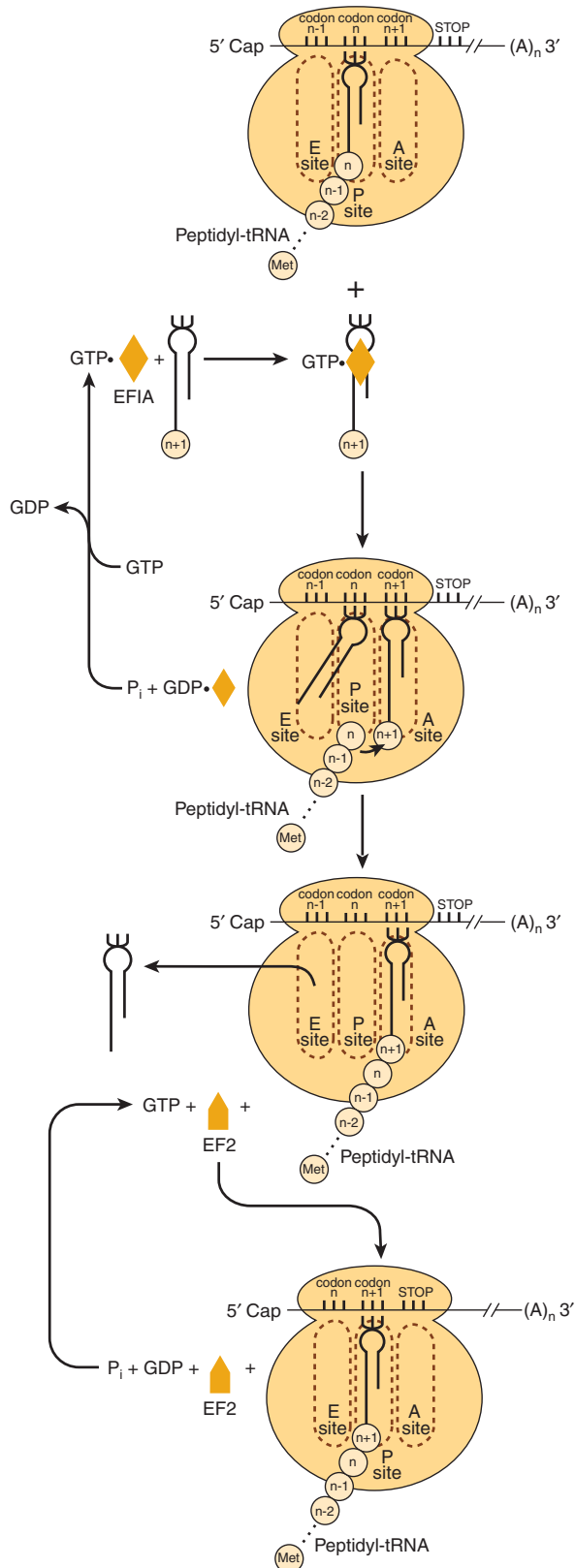

FIGURE 37-9 Diagrammatic representation of the peptide elongation process of protein synthesis. The small circles labeled $n-1$, n , $n+1$, etc. represent the amino acid residues of the newly formed protein molecule (in N-terminal to C-terminal orientation) and the corresponding codons in the mRNA. EF1A and EF2 represent elongation factors 1 and 2, respectively. The peptidyl-tRNA, aminoacyl-tRNA, and exit sites on the ribosome are represented by P site, A site, and E site, respectively.

TABLE 37-3 Evidence That rRNA Is a Peptidyl Transferase

- Ribosomes can make peptide bonds (albeit inefficiently) even when proteins are removed or inactivated.
- Certain parts of the rRNA sequence are highly conserved in all species.
- These conserved regions are on the surface of the RNA molecule.
- RNA can be catalytic in many other chemical reactions.
- Mutations that result in antibiotic resistance at the level of protein synthesis are more often found in rRNA than in the protein components of the ribosome.
- X-ray crystal structure of large subunit bound to tRNAs suggests detailed mechanism.

The charging of the tRNA molecule with the aminoacyl moiety requires the hydrolysis of an ATP to an AMP, equivalent to the hydrolysis of two ATPs to two ADPs and phosphates. The entry of the aminoacyl-tRNA into the A site results in the hydrolysis of one GTP to GDP and phosphate. Translocation of the newly formed peptidyl-tRNA in the A site into the P site by EF2 similarly results in hydrolysis of GTP to GDP and phosphate. Thus, the energy requirements for the formation of one peptide bond include the equivalent of the hydrolysis of two ATP molecules to ADP and of two GTP molecules to GDP, or the hydrolysis of four high-energy phosphate bonds. A eukaryotic ribosome can incorporate as many as six amino acids per second; prokaryotic ribosomes incorporate as many as 18 per second. Thus, the energy requiring process of peptide synthesis occurs with great speed and accuracy until a termination codon is reached.

Termination Occurs When a Stop Codon Is Recognized

In comparison to initiation and elongation, termination is a relatively simple process (Figure 37-10). After multiple cycles of elongation culminating in polymerization of the specific amino acids into a protein molecule, the stop or terminating codon of mRNA (UAA, UAG, UGA) appears in the A site. Normally, there is no tRNA with an anticodon capable of recognizing such a termination signal. **Releasing factor RF1** recognizes that a stop codon resides in the A site (Figure 37-10). RF1 is bound by a complex consisting of **releasing factor RF3** with bound GTP. This complex, with the peptidyl transferase, promotes hydrolysis of the bond between the peptide and the tRNA occupying the P site. Thus, a water molecule rather than an amino acid is added. This hydrolysis releases the protein and the tRNA from the P site. Upon hydrolysis and release, the 80S ribosome dissociates into its 40S and 60S subunits, which are then recycled (Figure 37-7). Therefore, the releasing factors are proteins that hydrolyze the peptidyl-tRNA bond when a stop codon occupies the A site. The mRNA is then released from the ribosome, which dissociates into its component 40S and 60S subunits, and another cycle can be repeated.

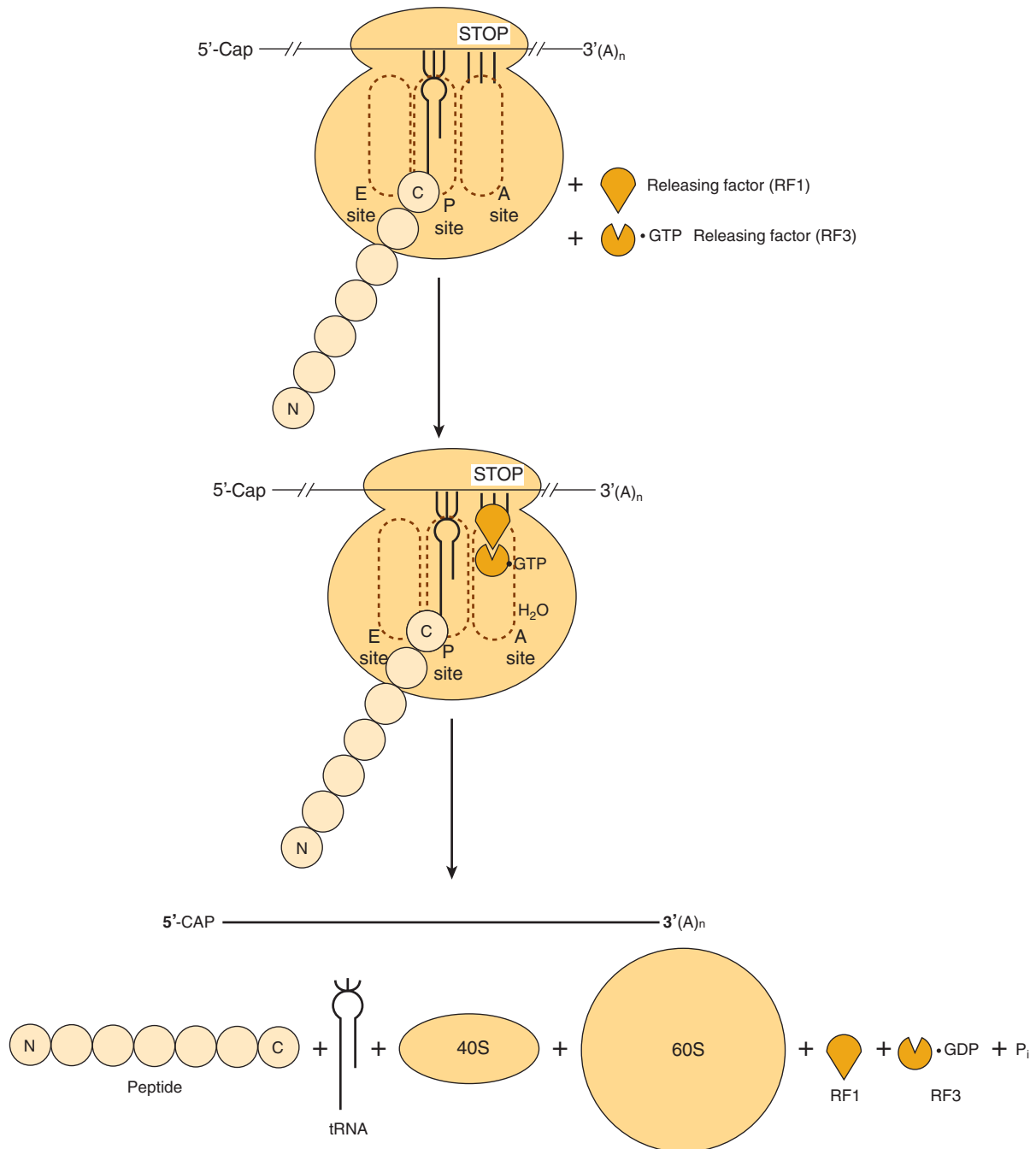

FIGURE 37-10 Diagrammatic representation of the termination process of protein synthesis. The peptidyl-tRNA, aminoacyl-tRNA and exit sites are indicated as P site, A site, and E site, respectively. The termination (stop) codon is indicated by the three vertical bars and stop. Releasing factor RF1 binds to the stop codon in the A site. Releasing factor RF3, with bound GTP, binds to RF1. Hydrolysis of the peptidyl-tRNA complex is shown by the entry of H₂O. N and C indicate the amino- and carboxy-terminal amino acids of the nascent polypeptide chain, respectively, and illustrate the polarity of protein synthesis. Termination results in release of the mRNA, the newly synthesized protein, free tRNA, 40S and 60S subunits, as well as RF1, GDP-bound RF3 and inorganic P_i, as shown at bottom right.

Polysomes Are Assemblies of Ribosomes

Many ribosomes can translate the same mRNA molecule simultaneously. Because of their relatively large size, the ribosome particles cannot attach to an mRNA any closer than 35 nucleotides apart. Multiple ribosomes on the same mRNA molecule form a **polysome**, or “**polysome**” (Figure 37-7). In an unrestricted

system, the number of ribosomes attached to an mRNA (and thus the size of polysomes) correlates positively with the length of the mRNA molecule.

Polysomes actively synthesizing proteins can exist as free particles in the cellular cytoplasm or may be attached to sheets of membranous cytoplasmic material referred to

as **endoplasmic reticulum**. Attachment of the particulate polyribosomes to the endoplasmic reticulum is responsible for its “rough” appearance as seen by electron microscopy. The proteins synthesized by the attached polyribosomes are extruded into the cisternal space between the sheets of rough endoplasmic reticulum and are exported from there. Some of the protein products of the rough endoplasmic reticulum are packaged by the Golgi apparatus for eventual export (see Chapter 46). The polyribosomal particles free in the cytosol are responsible for the synthesis of proteins required for intracellular functions.

Nontranslating mRNAs Can Form Ribonucleoprotein Particles That Accumulate in Cytoplasmic Organelles Termed P Bodies

mRNAs, bound by specific packaging proteins and exported from the nucleus as **ribonucleoproteins particles (mRNPs)** sometimes do not immediately associate with ribosomes to be translated. Instead, specific mRNAs can associate with the protein constituents that form **P bodies**, small dense compartments that incorporate mRNAs as mRNPs (**Figure 37–11**). These cytoplasmic organelles are related to similar small mRNA-containing granules found in neurons and certain maternal cells. P bodies are sites of translation repression and mRNA decay. Over 35 distinct proteins have been suggested to reside exclusively or extensively within P bodies. These proteins range from mRNA decapping enzymes, RNA

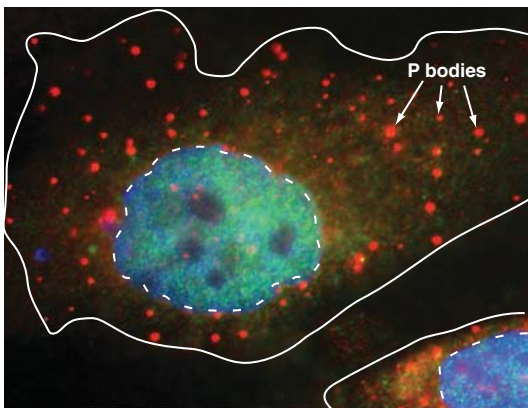

FIGURE 37–11 The P body is a cytoplasmic organelle involved in mRNA metabolism. Shown is a photomicrograph of two mammalian cells in which a single distinct protein constituent of the P body has been visualized using the cognate specific fluorescently labeled antibody. P bodies appear as small red circles of varying size throughout the cytoplasm. The cell plasma membranes are indicated by a solid white line, nuclei by a dashed line. Nuclei were counterstained using a fluorescent dye with different fluorescence excitation/emission spectra from the labeled antibody used to identify P bodies; the nuclear stain intercalates between the DNA base pairs and appears as blue/green. Modified from <http://www.mcb.arizona.edu/parker/WHAT/what.htm>. (Used with permission of Dr Roy Parker.)

helicases and RNA exonucleases (5′-3′ and 3′-5′), to components involved in miRNA function and mRNA quality control. However, incorporation of an mRNP is not an unequivocal mRNA “death sentence.” Indeed, though the mechanisms are not yet fully understood, certain mRNAs appear to be temporarily stored in P bodies and then retrieved and utilized for protein translation. This suggests that an equilibrium exists where the cytoplasmic functions of mRNA (translation and degradation) are controlled by the dynamic interaction of mRNA with polysomes and P bodies.

The Machinery of Protein Synthesis Can Respond to Environmental Threats

Ferritin, an iron-binding protein, prevents ionized iron (Fe^{2+}) from reaching toxic levels within cells. Elemental iron stimulates ferritin synthesis by causing the release of a cytoplasmic protein that binds to a specific region in the 5′ nontranslated region of ferritin mRNA. Disruption of this protein-mRNA interaction activates ferritin mRNA and results in its translation. This mechanism provides for rapid control of the synthesis of a protein that sequesters Fe^{2+} , a potentially toxic molecule (see Figure 52–8). Similarly environmental stress and starvation inhibit the positive roles of mTOR (Figure 37–8; Figure 42–8) on promoting activation of eIF-4F and 48S complex formation.

Many Viruses Co-Opt the Host Cell Protein Synthesis Machinery

The protein synthesis machinery can also be modified in deleterious ways. Viruses replicate by using host cell processes, including those involved in protein synthesis. Some viral mRNAs are translated much more efficiently than those of the host cell (eg, encephalomyocarditis virus). Others, such as reovirus and vesicular stomatitis virus, replicate efficiently, and thus their very abundant mRNAs have a competitive advantage over host cell mRNAs for limited translation factors. Other viruses inhibit host cell protein synthesis by preventing the association of mRNA with the 40S ribosome.

Poliovirus and other picornaviruses gain a selective advantage by disrupting the function of the 4F complex. The mRNAs of these viruses do not have a cap structure to direct the binding of the 40S ribosomal subunit (see above). Instead, the 40S ribosomal subunit contacts an **internal ribosomal entry site (IRES)** in a reaction that requires 4G but not 4E. The virus gains a selective advantage by having a protease that attacks 4G and removes the amino terminal 4E binding site. Now the 4E-4G complex (4F) cannot form, so the 40S ribosomal subunit cannot be directed to host capped mRNAs, abolishing host cell protein synthesis. The 4G fragment can direct binding of the 40S ribosomal subunit to IRES-containing mRNAs, so viral mRNA translation is very efficient (**Figure 37–12**). These viruses also promote the dephosphorylation of BP1 (PHAS-1), thereby decreasing cap (4E)-dependent translation (Figure 37–8).

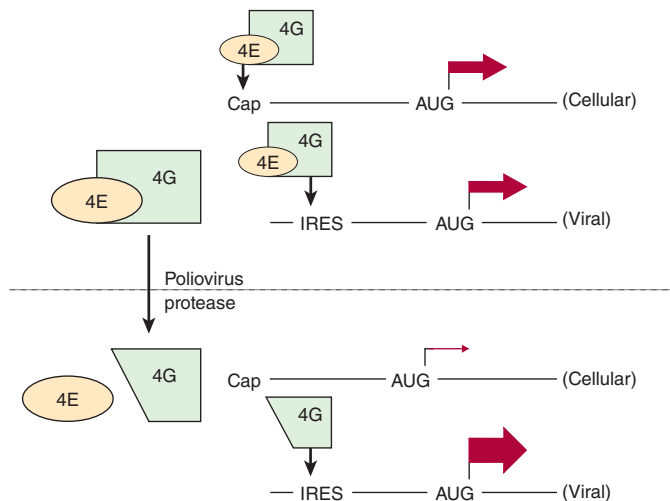

FIGURE 37–12 Picornaviruses disrupt the 4F complex. The 4E-4G complex (4F) directs the 40S ribosomal subunit to the typical capped mRNA (see text). However, 4G alone is sufficient for targeting the 40S subunit to the internal ribosomal entry site (IRES) of certain viral mRNAs. To gain selective advantage, some viruses (eg, poliovirus) express a protease that cleaves the 4E binding site from the amino terminal end of 4G. This truncated 4G can direct the 40S ribosomal subunit to mRNAs that have an IRES but not to those that have a cap (ie, host cell mRNAs). The widths of the arrows indicate the rate of translation initiation from the AUG codon in each example. Other viruses utilize distinct processes to effect selective initiation of translation on their cognate viral mRNAs via IRES elements.

POSTTRANSLATIONAL PROCESSING AFFECTS THE ACTIVITY OF MANY PROTEINS

Some animal viruses, notably HIV, poliovirus, and hepatitis A virus, synthesize long polycistronic proteins from one long mRNA molecule. The protein molecules translated from these long mRNAs are subsequently cleaved at specific sites to provide the several specific proteins required for viral function. In animal cells, many cellular proteins are synthesized from the mRNA template as a precursor molecule, which then must be modified to achieve the active protein. The prototype is insulin, which is a small protein having two polypeptide chains with interchain and intrachain disulfide bridges. The molecule is synthesized as a single chain precursor, or **prohormone**, which folds to allow the disulfide bridges to form. A specific protease then clips out the segment that connects the two chains which form the functional insulin molecule (see Figure 41–12).

Many other peptides are synthesized as proproteins that require modifications before attaining biologic activity. Many of the posttranslational modifications involve the removal of amino terminal amino acid residues by specific aminopeptidases (see Figure 41–14). By contrast, collagen, an abundant protein in the extracellular spaces of higher eukaryotes, is synthesized as procollagen. Three procollagen polypeptide molecules, frequently not identical in sequence, align themselves in a particular way that is dependent upon the existence of specific

amino terminal peptides (see Figure 5–11). Specific enzymes then carry out hydroxylations and oxidations of specific amino acid residues within the procollagen molecules to provide cross-links for greater stability. Amino terminal peptides are cleaved off the molecule to form the final product—a strong, insoluble collagen molecule. Many other posttranslational modifications of proteins occur. Covalent modification by acetylation, phosphorylation, methylation, ubiquitylation, and glycosylation is common, for example (see Chapter 5; Table 35–1).

MANY ANTIBIOTICS WORK BY SELECTIVELY INHIBITING PROTEIN SYNTHESIS IN BACTERIA

Ribosomes in bacteria and in the mitochondria of higher eukaryotic cells differ from the mammalian ribosome described in Chapter 34. The bacterial ribosome is smaller (70S vs 80S) and has a different, somewhat simpler complement of RNA and protein molecules. This difference can be exploited for clinical purposes because many effective antibiotics interact specifically with the proteins and RNAs of prokaryotic ribosomes and thus only inhibit bacterial protein synthesis. This results in growth arrest or death of the bacterium. The most useful members of this class of **antibiotics** (eg, **tetracyclines**, **lincomycin**, **erythromycin**, and **chloramphenicol**) do not interact with components of eukaryotic ribosomes and thus are not toxic to eukaryotes. Tetracycline prevents the binding of aminoacyl-tRNAs to the bacterial ribosome A site. Chloramphenicol and the macrolide class of antibiotics work by binding to 23S rRNA, which is interesting in view of the newly appreciated role of rRNA in peptide bond formation through its peptidyl transferase activity. It should be mentioned that the close similarity between prokaryotic and mitochondrial ribosomes can lead to complications in the use of some antibiotics.

Other antibiotics inhibit protein synthesis on all ribosomes (**puromycin**) or only on those of eukaryotic cells (cycloheximide). Puromycin (**Figure 37–13**) is a structural analog of tyrosinyl-tRNA. Puromycin is incorporated via the A site on the ribosome into the carboxyl terminal position of a peptide but causes the premature release of the polypeptide. Puromycin, as a tyrosinyl-tRNA analog, effectively inhibits protein synthesis in both prokaryotes and eukaryotes. Cycloheximide inhibits peptidyl transferase in the 60S ribosomal subunit in eukaryotes, presumably by binding to an rRNA component.

Diphtheria toxin, an exotoxin of *Corynebacterium diphtheriae* infected with a specific lysogenic phage, catalyzes the ADP-ribosylation of EF-2 on the unique amino acid diphthamide in mammalian cells. This modification inactivates EF-2 and thereby specifically inhibits mammalian protein synthesis. Many animals (eg, mice) are resistant to diphtheria toxin. This resistance is due to inability of diphtheria toxin to

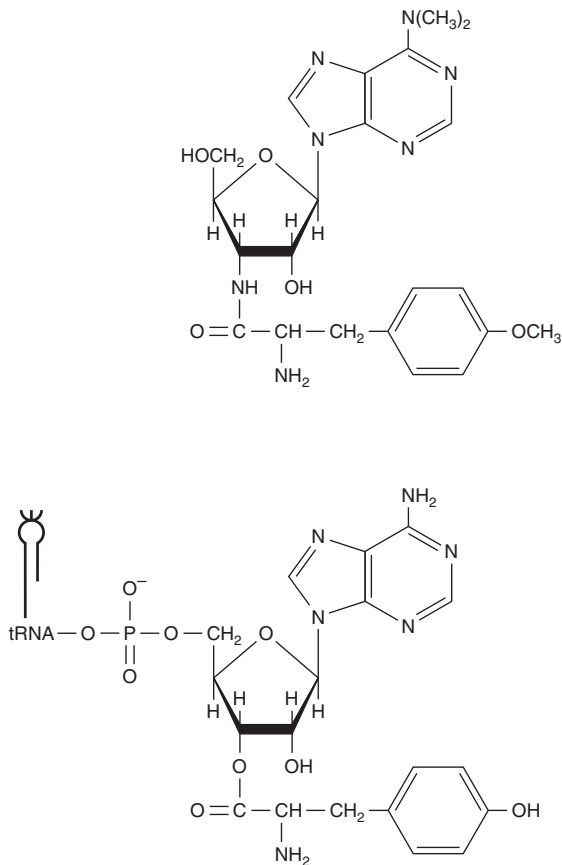

FIGURE 37-13 The comparative structures of the antibiotic puromycin (top) and the 3' terminal portion of tyrosinyl-tRNA (bottom).

cross the cell membrane rather than to insensitivity of mouse EF-2 to diphtheria toxin-catalyzed ADP-ribosylation by NAD.

Ricin, an extremely toxic molecule isolated from the castor bean, inactivates eukaryotic 28S ribosomal RNA by catalyzing the N-glycolytic cleavage or removal of a single adenine.

Many of these compounds—puromycin and cycloheximide in particular—are not clinically useful but have been important in elucidating the role of protein synthesis in the regulation of metabolic processes, particularly enzyme induction by hormones.

SUMMARY

- The flow of genetic information follows the sequence DNA → RNA → protein.
- The genetic information in a gene is transcribed into an RNA molecule such that the sequence of the latter is complementary to that in one strand of the DNA.
- Ribosomal RNA (rRNA), transfer RNA (tRNA), and messenger RNA (mRNA), are directly involved in protein synthesis.
- mi/siRNAs regulate mRNA function at the level of translation and/or stability.
- The information in mRNA is a continuous array of codons, each of which is three nucleotides long.

- The mRNA is read continuously from a start (AUG) to termination (UAA, UAG, UGA) codon.
- The open reading frame, or ORF, of the mRNA is the series of contiguous codons, each specifying a certain amino acid, that determines the precise amino acid sequence of the protein.
- Protein synthesis, like DNA and RNA synthesis, follows the 5' to 3' polarity of mRNA and can be divided into three processes: initiation, elongation, and termination.
- Mutant proteins arise when single-base substitutions result in codons that specify a different amino acid at a given position, when a stop codon results in a truncated protein, or when base additions or deletions alter the reading frame, so different codons are read.
- A variety of compounds, including several antibiotics, inhibit protein synthesis by affecting one or more of the steps involved in protein synthesis.

REFERENCES

- Crick FH, Barnett L, Brenner S, et al: General nature of the genetic code for proteins. *Nature* 1961;192:1227-1232.
- Decker CJ, Parker R: P-bodies and stress granules: possible roles in the control of translation and mRNA degradation. *Cold Spring Harb Perspect Biol* 2012; 4:a012286.doi: 10.1101/cshperspect.a012286.
- Hinnebusch AG: Molecular mechanism of scanning and start codon selection in eukaryotes. *Microbiol Mol Biol Rev* 2011;75:434-467.
- Jenner L, Melnikov S, Garreau de Loubresse N, et al: Crystal structure of the 80S yeast ribosome. *Curr Opin Struct Biol* 2012; 22:759-767.
- Kimball SR, Jefferson LS: Control of translation initiation through integration of signals generated by hormones, nutrients, and exercise. *J Biol Chem* 2009;285:29027-29032.
- Kozak M: Structural features in eukaryotic mRNAs that modulate the initiation of translation. *J Biol Chem* 1991;266:1986-1970.
- Liu CC, Schultz PG: Adding new chemistries to the genetic code. *Annu Rev Biochem* 2010;79:413-444.
- Maquat LE, Tarn WY, Isken O: The pioneer round of translation: features and functions. *Cell* 2010;142:368-374.
- Mauger DM, Siegfried NA, Weeks KM: The genetic code as expressed through relationships between mRNA structure and protein function. *FEBS Lett* 2013 587:1180-1188.
- Moore PB, Steitz TA: The roles of RNA in the synthesis of protein. *Cold Spring Harb Perspect Biol* 2011;3:a003780. doi: 10.1101/cshperspect.a003780.
- Silvera D, Formenti SC, Schneider RJ: Translational control in cancer. *Nat Rev Cancer* 2010;10:254-266.
- Sonenberg N, Hinnebusch AG: Regulation of translation initiation in eukaryotes: mechanisms and biological targets. *Cell* 2010;136:731-745.
- Spriggs KA, Bushell M, Willis AE: Translational regulation of gene expression during conditions of cell stress. *Mol Cell* 2010;40:228-237.
- Thompson SR: Tricks an IRES uses to enslave ribosomes. *Trends Microbiol* 2012;20:558-566.
- Wang Q, Parrish AR, Wang L: Expanding the genetic code for biological studies. *Chem Biol* 2009;16:323-336.
- Weatherall DJ: Thalassaemia: the long road from bedside to genome. *Nat Rev Genet* 2004;5:625-631.
- Wilson DN: Ribosome-targeting antibiotics and mechanisms of bacterial resistance. *Nat Rev Microbiol* 2013;12:35-48.

Regulation of Gene Expression

P. Anthony Weil, PhD

OBJECTIVES

After studying this chapter, you should be able to:

- Explain that the many steps involved in the vectorial processes of gene expression, which range from targeted modulation of gene copy number, to gene rearrangement, to transcription, to mRNA processing and transport from the nucleus, to translation, to protein subcellular compartmentalization, to posttranslational modification and degradation, are all subject to regulatory control, both positive and negative. Changes in any, or multiple of these processes, can increase or decrease the amount and/or activity of the cognate gene product.
- Appreciate that DNA binding transcription factors, proteins that bind to specific DNA sequences that are physically linked to their target transcriptional promoter elements, can either activate or repress gene transcription.
- Recognize that DNA binding transcription factors are often modular proteins that are composed of structurally and functionally distinct domains, which can directly or indirectly control mRNA gene transcription, either through contacts with RNA polymerase and its cofactors, or through interactions with coregulators that modulate nucleosome structure, composition and position via histone covalent modifications and/or nucleosome displacement.
- Understand that nucleosome-directed regulatory events typically increase or decrease the accessibility of the underlying DNA such as enhancer or promoter sequences, although nucleosome modification can also create new binding sites for other coregulators.
- Understand that the processes of gene transcription, RNA processing, and nuclear export of RNA are all coupled.

BIOMEDICAL IMPORTANCE

Organisms alter expression of genes in response to genetic developmental cues or programs, environmental challenges, or disease, by modulating the amount, the spatial, and/or the temporal patterns of gene expression. The mechanisms controlling gene expression have been studied in detail and often involve modulation of gene transcription. Control of transcription ultimately results from changes in the mode of interaction of specific regulatory molecules, usually proteins, with various regions of DNA in the controlled gene. Such interactions can either have a positive or negative effect on transcription. Transcription control can result in tissue-specific gene expression, and gene regulation is influenced by hormones, growth factors, heavy metals, and chemicals.

In addition to transcription level controls, gene expression can also be modulated by gene amplification, gene rearrangement, posttranscriptional modifications, RNA stabilization, translational control, protein modification, protein compartmentalization, and protein stabilization. Many of the mechanisms that control gene expression are used to respond to developmental cues, growth factors, hormones, environmental agents, and therapeutic drugs. Dysregulation of gene expression can lead to human disease. Thus, a molecular understanding of these processes can lead to development of therapeutic agents that alter pathophysiologic mechanisms or inhibit the function or arrest the growth of pathogenic organisms.

REGULATED EXPRESSION OF GENES IS REQUIRED FOR DEVELOPMENT, DIFFERENTIATION, & ADAPTATION

The genetic information present in each normal somatic cell of a metazoan organism is practically identical. The genetically reproducible, hardwired exceptions are found in those few cells that have amplified or rearranged genes in order to perform specialized cellular functions. Of course in various disease states chromosome integrity is altered (ie, cancer; Figure 56–11) sometimes even at the whole chromosome level (eg, trisomy 21, that causes Downs syndrome). Expression of the genetic information must be regulated during ontogeny and differentiation of the organism and its cellular components. Furthermore, in order for the organism to adapt to its environment and to conserve energy and nutrients, the expression of genetic information must be cued to extrinsic signals and respond only when necessary. As organisms have evolved, more sophisticated regulatory mechanisms have appeared which provide the organism and its cells with the responsiveness necessary for survival in a complex environment. Mammalian cells possess about 1000 times more genetic information than does the bacterium *Escherichia coli*. Much of this additional genetic information is probably involved in regulation of gene expression during the differentiation of tissues and biologic processes in the multicellular organism and in ensuring that the organism can respond to complex environmental challenges.

In simple terms, there are only two types of gene regulation: **positive regulation** and **negative regulation** (Table 38–1). When the expression of genetic information is quantitatively increased by the presence of a specific regulatory element, regulation is said to be positive; when the expression of genetic information is diminished by the presence of a specific regulatory element, regulation is said to be negative. The element or molecule mediating negative regulation is said to be a **negative regulator**, a **silencer** or **repressor**; that mediating positive regulation is a **positive regulator**, an **enhancer** or **activator**. However, a **double negative** has the effect of acting as a positive. Thus, an effector that inhibits the function of a negative regulator will appear to bring about a positive regulation. Many regulated

TABLE 38–1 Effects of Positive and Negative Regulation on Gene Expression

	Rate of Gene Expression	
	Negative Regulation	Positive Regulation
Regulator present	Decreased	Increased
Regulator absent	Increased	Decreased

systems that appear to be induced are in fact **derepressed** at the molecular level. (See Chapter 9 for explanation of these terms.)

BIOLOGIC SYSTEMS EXHIBIT THREE TYPES OF TEMPORAL RESPONSES TO A REGULATORY SIGNAL

Figure 38–1 depicts the extent or amount of gene expression in three types of temporal response to an inducing signal. A **type A response** is characterized by an increased extent of gene expression that is dependent upon the continued presence of the inducing signal. When the inducing signal is removed, the amount of gene expression diminishes to its basal level, but the amount repeatedly increases in response to the reappearance of the specific signal. This type of response is commonly observed in prokaryotes in response to sudden changes of the intracellular concentration of a nutrient. It is also observed

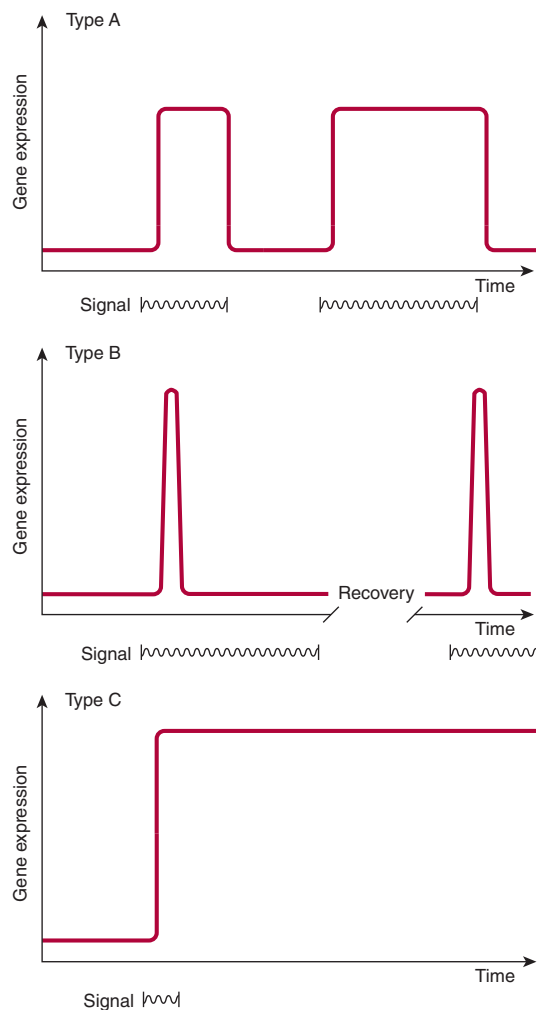

FIGURE 38–1 Diagrammatic representations of the responses of the extent of expression of a gene to specific regulatory signals (such as a hormone) as a function of time.

in many higher organisms after exposure to inducers such as hormones, nutrients, or growth factors (see Chapter 42).

A **type B response** exhibits an increased amount of gene expression that is transient even in the continued presence of the regulatory signal. After the regulatory signal has terminated and the cell has been allowed to recover, a second transient response to a subsequent regulatory signal may be observed. This phenomenon of response-desensitization recovery characterizes the action of many pharmacologic agents, but it is also a feature of many naturally occurring processes. This type of response commonly occurs during development of an organism, when only the transient appearance of a specific gene product is required although the signal persists.

The **type C response** pattern exhibits, in response to the regulatory signal, an increased extent of gene expression that persists indefinitely even after termination of the signal. The signal acts as a trigger in this pattern. Once expression of the gene is initiated in the cell, it cannot be terminated even in the daughter cells; it is therefore an irreversible and inherited alteration. This type of response typically occurs during the development of differentiated function in a tissue or organ.

Simple Unicellular and Multicellular Organisms Serve as Valuable Models for the Study of Gene Expression in Mammalian Cells

Analysis of the regulation of gene expression in prokaryotic cells helped establish the principle that information flows from the gene to a messenger RNA to a specific protein molecule. These studies were aided by the advanced genetic analyses that could be performed in prokaryotic and lower eukaryotic organisms such as baker's yeast, *Saccharomyces cerevisiae*, and the fruit fly, *Drosophila melanogaster*, among others. In recent years, the principles established in these studies, coupled with a variety of molecular biology techniques, have led to remarkable progress in the analysis of gene regulation in higher eukaryotic organisms, including mammals. In this chapter, the initial discussion will center on prokaryotic systems. The impressive genetic studies will not be described, but the physiology of gene expression will be discussed. However, nearly all of the conclusions about this physiology have been derived from genetic studies and confirmed by molecular genetic and biochemical experiments.

Some Features of Prokaryotic Gene Expression Are Unique

Before the physiology of gene expression can be explained, a few specialized genetic and regulatory terms must be defined for prokaryotic systems. In prokaryotes, the genes involved in a metabolic pathway are often present in a linear array called an **operon**, for example, the *lac* operon. An operon can be regulated by a single promoter or regulatory region. The **cistron** is the smallest unit of genetic expression. A single mRNA that encodes more than one separately translated protein is referred

to as a **polycistronic mRNA**. For example, the polycistronic *lac* operon mRNA is translated into three separate proteins (see below). Operons and polycistronic mRNAs are common in bacteria but not in eukaryotes.

An **inducible gene** is one whose expression increases in response to an **inducer** or **activator**, a specific positive regulatory signal. In general, inducible genes have relatively low basal rates of transcription. By contrast, genes with high basal rates of transcription are often subject to down regulation by repressors.

The expression of some genes is **constitutive**, meaning that they are expressed at a reasonably constant rate and not known to be subject to regulation. These are often referred to as **housekeeping genes**. As a result of mutation, some inducible gene products become constitutively expressed. A mutation resulting in constitutive expression of what was formerly a regulated gene is called a **constitutive mutation**.

Analysis of Lactose Metabolism in *E coli* Led to the Discovery of the Basic Principles of Gene Transcription Activation and Repression

Jacob and Monod in 1961 described their **operon model** in a classic paper. Their hypothesis was to a large extent based on observations on the regulation of lactose metabolism by the intestinal bacterium *E coli*. The molecular mechanisms responsible for the regulation of the genes involved in the metabolism of lactose are now among the best-understood in any organism. β -Galactosidase hydrolyzes the β -galactoside lactose to galactose and glucose. The structural gene for β -galactosidase (*lacZ*) is clustered with the genes responsible for the permeation of lactose into the cell (*lacY*) and for thiogalactoside transacetylase (*lacA*). The structural genes for these three enzymes, along with the *lac* promoter and *lac* operator (a regulatory region), are physically associated to constitute the **lac operon** as depicted in **Figure 38–2**. This genetic arrangement of the structural genes and their regulatory genes allows for **coordinate expression** of the three enzymes concerned with lactose metabolism. Each of these linked genes is transcribed into one large polycistronic mRNA molecule that contains multiple independent

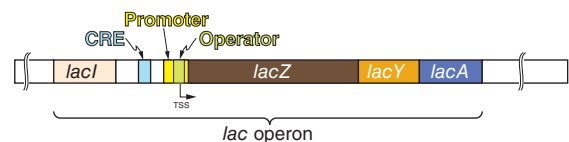

FIGURE 38–2 The positional relationships of the protein coding and regulatory elements of the *lac* operon. *lacZ* encodes β -galactosidase, *lacY* encodes a permease, and *lacA* encodes a thiogalactoside transacetylase. *lacI* encodes the *lac* operon repressor protein. Also shown is the transcription start site for *lac* operon transcription (TSS). Note that the binding site for the *lacI* protein (ie, *lac* repressor)—the *lac* operator (Operator) overlaps the *lac* promoter. Immediately upstream of the *lac* operon promoter is the binding site (CRE) for the cAMP binding protein, CAP, the positive regulator of *lac* operon transcription. See Figure 38-3 for more detail.

translation start (AUG) and stop (UAA) codons for each of the three cistrons. Thus, each protein is translated separately, and they are not processed from a single large precursor protein.

It is now conventional to consider that a gene includes regulatory sequences as well as the region that encodes the primary transcript. Although there are many historical exceptions, a gene is generally italicized in lower case and the encoded protein, when abbreviated, is expressed in roman type with the first letter capitalized. For example, the gene *lacI* encodes the repressor protein LacI. When *E. coli* is presented with lactose or some specific lactose analogs under appropriate nonrepressing conditions (eg, high concentrations of lactose, no or very low glucose in media; see below), the expression of the activities of β -galactosidase, galactoside permease, and thiogalactoside transacetylase is increased 100-fold to 1000-fold. This is a type A response, as depicted in Figure 38-1. The kinetics of induction can be quite rapid; *lac*-specific mRNAs are fully induced within 5 to 6 minutes after addition of lactose to a culture; β -galactosidase protein is maximal within 10 minutes. Under fully induced conditions, there can be up to 5000 β -galactosidase molecules per cell, an amount about 1000 times greater than the basal, uninduced level. Upon removal of the signal, that is, the inducer, the synthesis of these three enzymes declines.

When *E. coli* is exposed to both lactose and glucose as sources of carbon, the organisms first metabolize the glucose and then temporarily stop growing until the genes of the *lac* operon become induced to provide the ability to metabolize lactose as a usable energy source. Although lactose is present from the beginning of the bacterial growth phase, the cell does not induce those enzymes necessary for catabolism of lactose until the glucose has been exhausted. This phenomenon was first thought to be attributable to repression of the *lac* operon by some catabolite of glucose; hence, it was termed catabolite repression. It is now known that catabolite repression is in fact mediated by a **catabolite gene activator protein (CAP)** in conjunction with **cAMP** (see Figure 17-5). This protein is also referred to as the cAMP regulatory protein (CRP). The expression of many inducible enzyme systems or operons in *E. coli* and other prokaryotes is sensitive to catabolite repression, as discussed below.

The physiology of induction of the *lac* operon is well understood at the molecular level (**Figure 38-3**). Expression of the normal *lacI* gene of the *lac* operon is constitutive; it is expressed at a constant rate, resulting in formation of the subunits of the **lac repressor**. Four identical subunits with molecular weights of 38,000 assemble into a tetrameric Lac repressor molecule. The LacI repressor protein molecule, the product of *lacI*, has a very high affinity (dissociation constant, K_d about 10^{-13} mol/L) for the operator locus. The **operator locus** is a region of double-stranded DNA that exhibits a twofold rotational symmetry and an inverted palindrome (indicated by arrows about the dotted axis) in a region that is 21 bp long, as shown below:

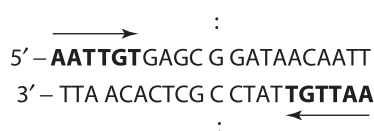

At any one time, only two of the four subunits of the repressor appear to bind to the operator, and within the 21-base-pair region nearly every base of each base pair is involved in LacI recognition and binding. The binding occurs mostly in the **major groove** without interrupting the base-paired, double-helical nature of the operator DNA. The **operator locus** is between the **promoter site**, at which the DNA-dependent RNA polymerase attaches to commence transcription, and the transcription initiation site of the **lacZ gene**, the structural gene for β -galactosidase (Figure 38-2). When bound to the operator locus, the LacI repressor molecule prevents transcription of the distal structural genes, *lacZ*, *lacY*, and *lacA* by interfering with the binding of RNA polymerase to the promoter; RNA polymerase and LacI repressor cannot be effectively bound to the *lac* operon at the same time. Thus, the LacI repressor molecule is a **negative regulator**, and in its presence (and in the absence of inducer; see below), expression from the *lacZ*, *lacY*, and *lacA* genes is very, very low. There are normally 20 to 40 repressor tetramer molecules in the cell, a concentration (20-40 10^{-9} mol/L) of tetramer sufficient to effect, at any given time, >95% occupancy of the one *lac* operator element in a bacterium, thus ensuring low (but not zero) basal *lac* operon gene transcription in the absence of inducing signals.

A lactose analog that is capable of inducing the *lac* operon while not itself serving as a substrate for β -galactosidase is an example of a **gratuitous inducer**. An example is isopropylthiogalactoside (IPTG). The addition of lactose or of a gratuitous inducer such as IPTG to bacteria growing on a poorly utilized carbon source (such as succinate) results in prompt induction of the *lac* operon enzymes. Small amounts of the gratuitous inducer or of lactose are able to enter the cell even in the absence of permease. The LacI repressor molecules—both those attached to the operator loci and those free in the cytosol—have a high affinity for the inducer. Binding of the inducer to repressor molecule induces a conformational change in the structure of the repressor and causes a decrease in operator DNA occupancy because its affinity for the operator is now 10^4 times lower (K_d about 10^{-9} mol/L) than that of LacI in the absence of IPTG. DNA-dependent RNA polymerase can now bind to the promoter (ie, Figures 36-3 and 36-8), and transcription will begin, although this process is relatively inefficient (see below). In such a manner, **an inducer derepresses the lac operon** and allows transcription of the structural genes for β -galactosidase, galactoside permease, and thiogalactoside transacetylase. Translation of the polycistronic mRNA can occur even before transcription is completed. Derepression of the *lac* operon allows the cell to synthesize the enzymes necessary to catabolize lactose as an energy source. Based on the physiology just described, IPTG-induced expression of transfected plasmids bearing the *lac* operator-promoter ligated to appropriate bioengineered constructs is commonly used to express mammalian recombinant proteins in *E. coli*.

In order for the RNA polymerase to form a PIC at the promoter site most efficiently, the cAMP-CAP complex must also be present in the cell. By an independent mechanism, the bacterium accumulates cAMP only when it is starved for a source

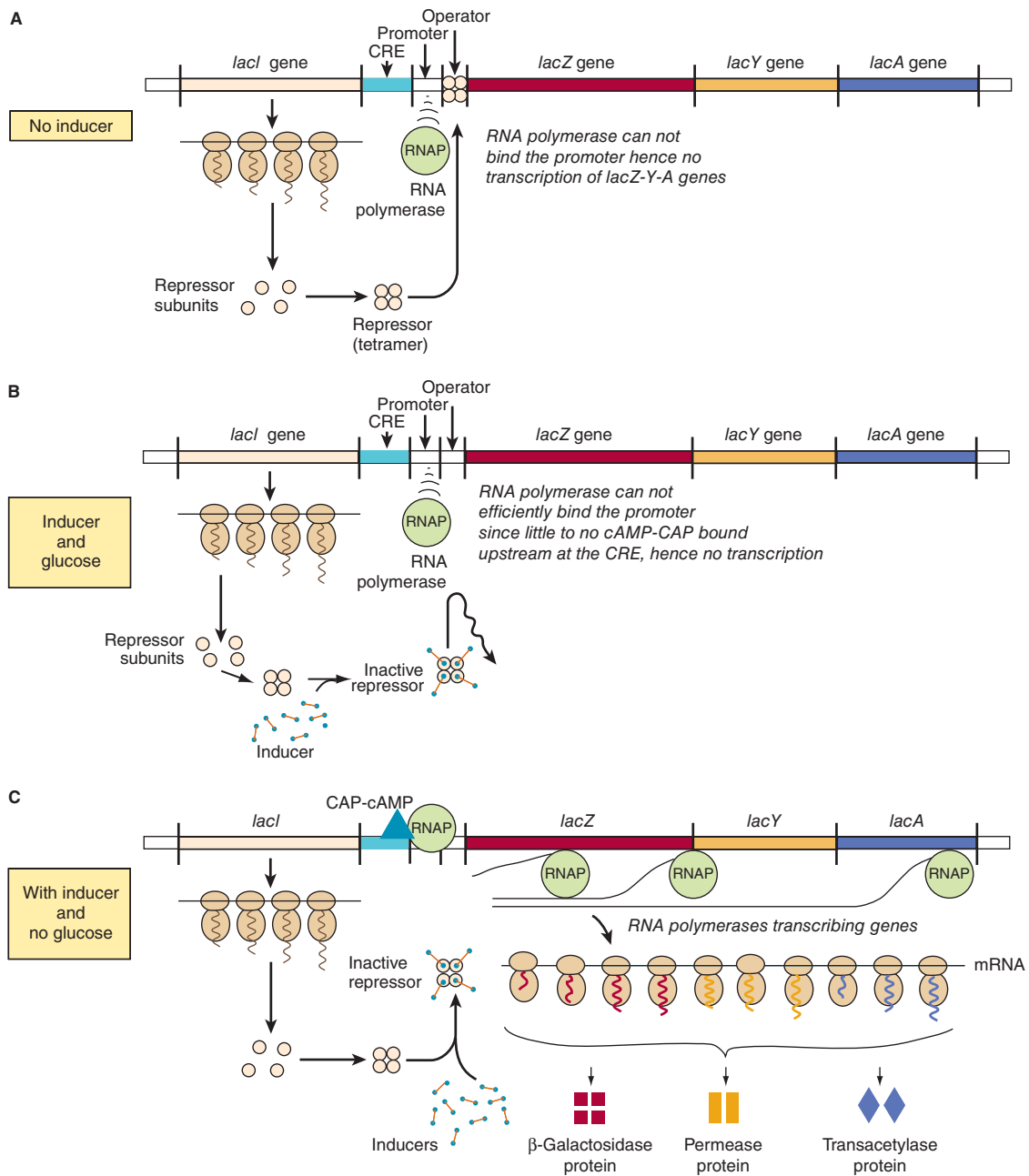

FIGURE 38-3 The mechanism of repression and derepression of the *lac* operon. When no inducer is present (A) the constitutively synthesized *lacI* gene products forms a repressor tetramer that binds to the operator. Repressor-operator binding prevents the binding of RNA polymerase and consequently prevents transcription of the *lacZ*, *lacY*, and *lacA* structural genes into a polycistronic mRNA. When inducer is present, but glucose is also present in the culture medium (B), the tetrameric repressor molecules are conformationally altered by inducer, and cannot efficiently bind to the operator locus (affinity of binding reduced >1000-fold). However, RNA polymerase will not efficiently bind the promoter and initiate transcription because positive protein-protein interactions between CRE-bound CAP protein fail to occur; thus the *lac* operon is not efficiently transcribed. However, when inducer is present and glucose is depleted from the medium (C) adenyl cyclase is activated and cAMP is produced. This cAMP binds with high affinity to its binding protein the Cyclic AMP Activator Protein, or CAP. The CAP-cAMP complex binds to its recognition sequence (CRE, the cAMP Response Element) located ~15 bp upstream of the promoter. Direct protein-protein contacts between the CRE-bound CAP and the RNA polymerase increases promoter binding >20-fold; hence RNAP will efficiently transcribe the *lac* operon and the polycistronic *lacZ*-*lacY*-*lacA* mRNA molecule formed can be translated into the corresponding protein molecules β -galactosidase, permease, and transacetylase as shown. This protein production enables cellular catabolism of lactose as the sole carbon source for growth.

of carbon. In the presence of glucose—or of glycerol in concentrations sufficient for growth—the bacteria will lack sufficient cAMP to bind to CAP because glucose inhibits adenyl cyclase, the enzyme that converts ATP to cAMP (see Chapter 41). Thus, in the presence of glucose or glycerol, cAMP-saturated CAP is lacking, so that the DNA-dependent RNA polymerase cannot initiate transcription of the *lac* operon at the maximal rate. However, in the presence of the CAP-cAMP complex, which binds to DNA just upstream of the promoter site, transcription occurs at maximal levels (Figure 38–3). Studies indicate that a region of CAP directly contacts the RNA polymerase α -subunit, and these protein–protein interactions facilitate the binding of RNAP to the promoter. Thus, the CAP–cAMP regulator is acting as a **positive regulator** because its presence is required for optimal gene expression. The *lac* operon is therefore controlled by two distinct, ligand-modulated DNA binding *trans*-factors; one that acts positively (cAMP-CRP complex) to facilitate productive binding of RNA polymerase to the promoter and one that acts negatively (LacI repressor) that antagonizes RNA polymerase promoter binding. Maximal activity of the *lac* operon occurs when glucose levels are low (high cAMP with CAP activation) and lactose is present (LacI is prevented from binding to the operator).

When the *lacI* gene has been mutated so that its product, LacI, is not capable of binding to operator DNA, the organism will exhibit **constitutive expression** of the *lac* operon. In a contrary manner, an organism with a *lacI* gene mutation that produces a LacI protein which prevents the binding of an inducer to the repressor will remain repressed even in the presence of the inducer molecule, because the inducer cannot bind to the repressor on the operator locus in order to derepress the operon. Similarly, bacteria harboring mutations in their *lac* operator locus such that the operator sequence will not bind a normal repressor molecule will constitutively express the *lac* operon genes. Mechanisms of positive and negative regulation comparable to those described here for the *lac* system have been observed in eukaryotic cells (see below).

The Genetic Switch of Bacteriophage Lambda (λ) Provides Another Paradigm for Understanding the Role of Protein-DNA Interactions and Transcriptional Regulation in Eukaryotic Cells

Like some eukaryotic viruses (eg, herpes simplex virus and HIV), some bacterial viruses can either reside in a dormant state within the host chromosomes or can replicate within the bacterium and eventually lead to lysis and killing of the bacterial host. Some *E. coli* harbor such a “temperate” virus, bacteriophage lambda (λ). When lambda infects an organism of that species, it injects its 45,000-bp, double-stranded, linear DNA genome into the cell (Figure 38–4). Depending upon the nutritional state of the cell, the lambda DNA will either **integrate** into the host genome (**lysogenic pathway**) and

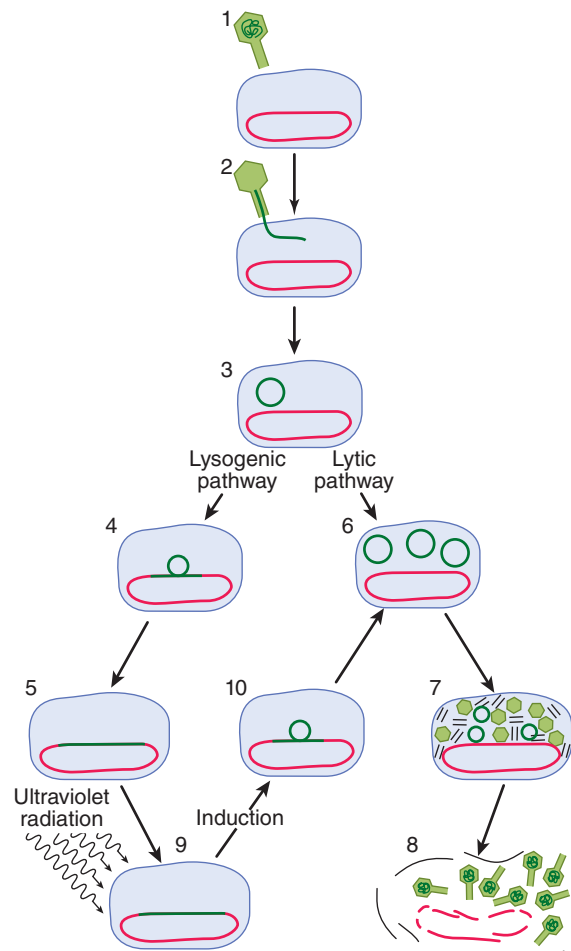

FIGURE 38–4 Alternate lifestyles of bacteriophage lambda.

Infection of the bacterium *E. coli* by phage lambda begins when a virus particle attaches itself to specific receptors on the bacterial cell (1) and injects its DNA (dark green line) into the cell (2, 3). Infection can take either of two courses depending on which of two sets of viral genes is turned on. In the lysogenic pathway, the viral DNA becomes integrated into the bacterial chromosome (red) (4, 5), where it replicates passively as part of the bacterial DNA during *E. coli* cell division. This dormant, genomically integrated virus is called a prophage, and the cell that harbors it is called a lysogen. In the alternative lytic mode of infection, the viral DNA excises from the *E. coli* chromosome and replicates itself (6) in order to direct the synthesis of viral proteins (7). About 100 new virus particles are formed. The proliferating viruses induce lysis of the cell (8). A prophage can be “induced” by a DNA damaging agent such as ultraviolet radiation (9). The inducing agent throws a switch (see text and Figure 38-5; the λ “molecular switch.”), so that a different set of viral genes is turned on. Viral DNA loops out of the chromosome (10) and replicates; the virus then proceeds along the lytic pathway. (Reproduced, with permission, from Ptashne M, Johnson AD, Pabo CO: A genetic switch in a bacterial virus. *Sci Am* [Nov] 1982;247:128.)

remain dormant until activated (see below), or it will commence **replicating** until it has made about 100 copies of complete, protein-packaged virus, at which point it causes lysis of its host (**lytic pathway**). The newly generated virus particles can then infect other susceptible hosts. Poor growth conditions favor lysogeny while good growth conditions promote the lytic pathway of lambda growth.

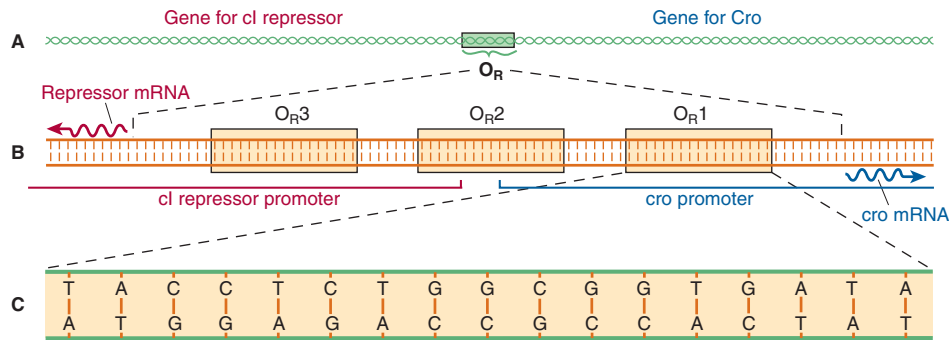

FIGURE 38-5 Genetic organization of the lambda lifestyle “molecular switch.” Right operator (O_R) is shown in increasing detail in this series of drawings. The operator is a region of the viral DNA some 70 bp long (A). To its left lies the gene encoding lambda repressor (*cI*), to its right the gene (*cro*) encoding the regulator protein Cro. When the operator region is enlarged (B), it is seen to include three subregions termed operators: O_{R1} , O_{R2} , and O_{R3} , each 17 bp long. They are recognition sites to which both λ *cI* repressor and Cro proteins can bind. The recognition sites overlap two divergent promoters—sequences of bases to which RNA polymerase binds in order to transcribe these genes into mRNA (wavy lines), that are translated into protein. Site O_{R1} is enlarged (C) to show its base sequence. (Reproduced, with permission, from Ptashne M, Johnson AD, Pabo CO: A genetic switch in a bacterial virus. *Sci Am* [Nov] 1982;247:128.)

When integrated into the host genome in its dormant state, lambda will remain in that state until activated by exposure of its bacterial host to DNA-damaging agents. In response to such a noxious stimulus, the dormant bacteriophage becomes “induced” and begins to transcribe and subsequently translate those genes of its own genome that are necessary for its excision from the host chromosome, its DNA replication, and the synthesis of its protein coat and lysis enzymes. This event acts like a trigger or type C (Figure 38-1) response; that is, once dormant lambda has committed itself to induction, there is no turning back until the cell is lysed and the replicated bacteriophage released. This switch from a dormant or **prophage state** to a **lytic infection** is well understood at the genetic and molecular levels and will be described in detail here; though less well understood at the molecular level, HIV and herpes viruses can behave similarly, transitioning from dormant to active states of infection.

The lytic/lysogenic genetic switching event in lambda is centered around an 80-bp region in its double-stranded DNA genome referred to as the “right operator” (O_R) (Figure 38-5A). The **right operator** is flanked on its left side by the gene for the lambda repressor protein, *cI*, and on its right side by the gene encoding another regulatory protein, the *cro* gene. When lambda is in its prophage state—that is, integrated into the host genome—the *cI* repressor gene is the *only* lambda gene that is expressed. When the bacteriophage is undergoing lytic growth, the *cI* repressor gene is not expressed, but the *cro* gene—as well as many other lambda genes—is expressed. That is, when the ***cI* repressor gene is on, the *cro* gene is off**, and when the ***cro* gene is on, the *cI* repressor gene is off**. As we shall see, these two genes regulate each other’s expression and thus, ultimately, the decision between lytic and lysogenic growth of lambda. This decision between repressor gene transcription and *cro* gene

transcription is a paradigmatic example of a molecular transcriptional switch.

The 80-bp lambda right operator, O_R , can be subdivided into three discrete, evenly spaced, 17-bp *cis*-active DNA elements that represent the binding sites for either of two bacteriophage lambda regulatory proteins. Importantly, the nucleotide sequences of these three tandemly arranged sites are similar but not identical (Figure 38-5B). The three related *cis*-elements, termed operators O_{R1} , O_{R2} , and O_{R3} , can be bound by either *cI* or Cro proteins. However, the relative affinities of *cI* and Cro for each of the sites vary, and this differential binding affinity is central to the appropriate operation of the lambda phage lytic or lysogenic “molecular switch.” The DNA region between the *cro* and repressor genes also contains two promoter sequences that direct the binding of RNA polymerase in a specified orientation, where it commences transcribing adjacent genes. One promoter directs RNA polymerase to transcribe in the rightward direction and, thus, to transcribe *cro* and other distal genes, while the other promoter directs the transcription of the *cI* repressor gene in the leftward direction (Figure 38-5B).

The product of the *cI* repressor gene, the 236-amino-acid λ ***cI* repressor protein** is a **two-domain** molecule with **amino terminal DNA binding domain** and **carboxyl terminal dimerization domain**. Association of one repressor protein with another forms a dimer. *cI* repressor **dimers** bind to operator DNA much more tightly than do monomers (Figure 38-6A to 38-6C).

The product of the *cro* gene, the 66-amino-acid, 9-kDa **Cro protein**, has a single domain but also binds the operator DNA more tightly as a dimer (Figure 38-6D). The Cro protein’s single domain mediates both operator binding and dimerization.

In a lysogenic bacterium—that is, a bacterium containing an integrated dormant lambda prophage—the lambda repressor dimer binds **preferentially** to O_{R1} but in so doing,

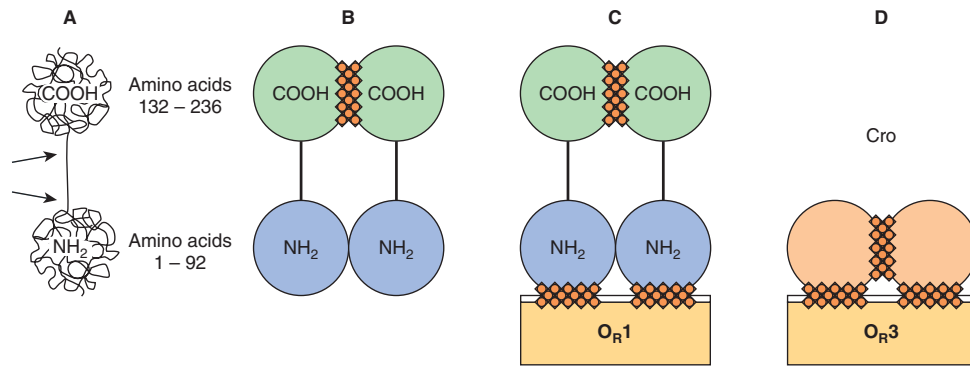

FIGURE 38-6 Schematic molecular structures of lambda regulatory proteins *cI* and *cro*.

The lambda repressor protein is a polypeptide chain 236 amino acids long. The chain folds itself into a dumbbell shape with two substructures: an amino terminal (NH₂) domain and a carboxyl terminal (COOH) domain. The two domains are linked by a region of the chain that is less structured and susceptible to cleavage by proteases (indicated by the two arrows in **A**). Single repressor molecules (monomers) tend to reversibly associate to form dimers. **(B)** A dimer is held together mainly by contact between the carboxyl terminal domains (hatching). *cI* repressor dimers bind to (and can dissociate from) the recognition sites in the operator region; they display differential affinities for the three operator sites, $O_{R1} > O_{R2} > O_{R3}$ **(C)**. It is the DBD of the repressor molecule that makes contact with the DNA (hatching). *Cro* **(D)** has a single domain that promotes *cro*-*cro* dimerization, and a DNA binding domain that promotes binding of dimers to operator. It is important that *cro* exhibits the highest affinity for *O_R3*, opposite the sequence binding preference of the *cI* protein. (Reproduced, with permission, from Ptashne M, Johnson AD, Pabo CO: A genetic switch in a bacterial virus. *Sci Am* [Nov] 1982;247:128.)

by a cooperative interaction, enhances the binding (by a factor of 10) of another repressor dimer to *O_R2* (**Figure 38-7**). The affinity of repressor for *O_R3* is the least of the three operator subregions. The binding of repressor to *O_R1* has two major effects. The occupation of *O_R1* by repressor blocks the binding of RNA polymerase to the rightward promoter and in that way prevents expression of *cro*. Second, as mentioned above, repressor dimer bound to *O_R1* enhances the binding of repressor dimer to *O_R2*. The binding of repressor to *O_R2* has the important added effect of enhancing the binding of RNA polymerase to the leftward promoter that overlaps *O_R3* and thereby enhances transcription and subsequent expression of the repressor gene. This enhancement of transcription is mediated through direct protein-protein interactions between promoter-bound RNA polymerase and *O_R2*-bound repressor, much as described above for CAP protein and RNA polymerase on the *lac* operon. Thus, the λ ***cI* repressor** is both a **negative regulator**, by preventing transcription of *cro*, and a **positive regulator**, by enhancing transcription of its own gene, *cI*. This dual effect of repressor is responsible for the stable state of the dormant lambda bacteriophage; not only does the repressor prevent expression of the genes necessary for lysis, but it also promotes expression of itself to stabilize this state of differentiation. In the event that intracellular repressor protein concentration becomes very high the excess repressor will bind to *O_R3* and by so doing diminish transcription of the repressor gene from the leftward promoter, by blocking RNAP binding to the *cI* promoter, until the repressor concentration drops and repressor dissociates itself from *O_R3*. Interestingly, similar examples of repressor proteins also having the ability to activate transcription have been observed in eukaryotes.

With such a stable, repressive, *cI*-mediated, lysogenic state, one might wonder how the lytic cycle could ever be entered. However, this process does occur quite efficiently. When a DNA-damaging signal, such as ultraviolet light, strikes the lysogenic host bacterium, fragments of single-stranded DNA are generated that activate a specific co-protease coded by a bacterial gene and referred to as *recA* (**Figure 38-7**). The activated *recA* protease hydrolyzes the portion of the repressor protein that connects the amino terminal and carboxyl terminal domains of that molecule (see **Figure 38-6A**). Such cleavage of the repressor domains causes the repressor dimers to dissociate, which in turn causes dissociation of the repressor molecules from *O_R2* and eventually from *O_R1*. The effects of removal of repressor from *O_R1* and *O_R2* are predictable. RNA polymerase immediately has access to the rightward promoter and commences transcribing the *cro* gene, and the enhancement effect of the repressor at *O_R2* on leftward transcription is lost (**Figure 38-7**).

The resulting newly synthesized *Cro* protein also binds to the operator region as a dimer, but its order of preference is opposite to that of repressor (**Figure 38-7**). That is, *Cro* binds most tightly to *O_R3*, but there is no cooperative effect of *Cro* at *O_R3* on the binding of *Cro* to *O_R2*. At increasingly higher concentrations of *Cro*, the protein will bind to *O_R2* and eventually to *O_R1*.

Occupancy of *O_R3* by *Cro* immediately turns off transcription from the leftward *cI* promoter and in that way prevents any further expression of the repressor gene. The molecular switch is thus completely “thrown” in the lytic direction. The *cro* gene is now expressed, and the repressor gene is fully turned off. This event is irreversible, and the expression of other lambda genes

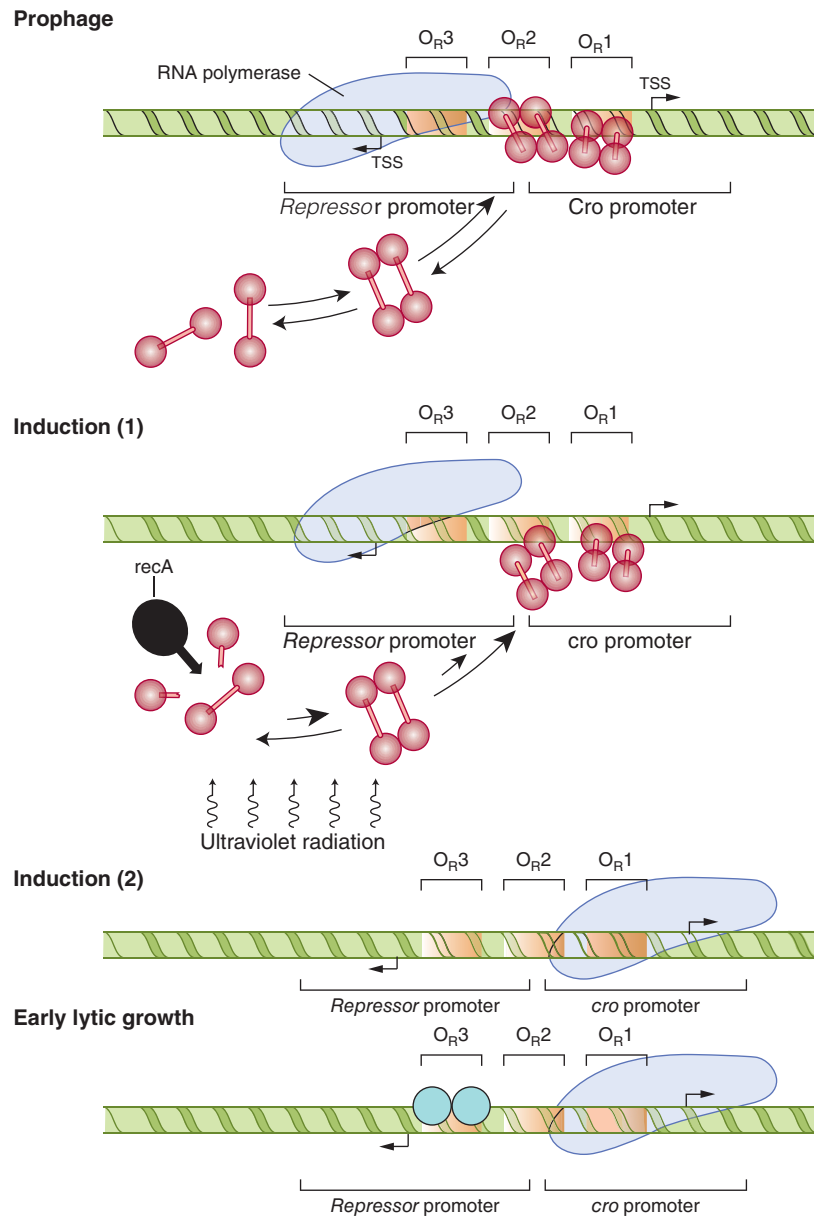

FIGURE 38-7 Configuration of the lytic/lysogenic switch is shown at four stages of the lambda life cycle. The lysogenic pathway (in which the virus remains dormant as a prophage) is selected when a repressor dimer binds to O_R1 , thereby making it likely that O_R2 will be filled immediately by another dimer due to the cooperative nature of cl - O_R DNA binding. In the prophage (**top**), the repressor dimers bound at O_R1 and O_R2 prevent RNA polymerase from binding to the rightward *cro* promoter and so block the synthesis of Cro (negative control). Simultaneously these DNA-bound *cl* proteins enhance the binding of polymerase to the leftward promoter (positive control), with the result that the repressor gene is transcribed into RNA (wavy line; initiation at *cl* gene transcription start site; TSS) and more repressor is synthesized, maintaining the lysogenic state. The prophage is induced (**middle**) when ultraviolet radiation activates the protease *recA*, which cleaves *cl* repressor monomers. The equilibrium of free monomers, free dimers, and bound dimers is thereby shifted by mass action, and dimers dissociate from the operator sites. RNA polymerase is no longer stimulated to bind to the leftward promoter, so that repressor is no longer synthesized. As induction proceeds, all the operator sites become vacant, thus polymerase can bind to the rightward promoter and Cro is synthesized (*cro* TSS shown). During early lytic growth, a single *Cro* dimer binds to O_R3 (light blue shaded circles), the site for which it has the highest affinity thereby occluding the *cl* promoter. Consequently, RNA polymerase cannot bind to the leftward promoter, but the rightward promoter remains accessible. Polymerase continues to bind there, transcribing *cro* and other early lytic genes. Lytic growth ensues (**bottom**). (Reproduced, with permission, from Ptashne M, Johnson AD, Pabo CO: A genetic switch in a bacterial virus. *Sci Am* [Nov] 1982;247:128.)

begins as part of the lytic cycle. When Cro repressor concentration becomes quite high, it will eventually occupy O_R1 and in so doing reduce the expression of its own gene, a process that is necessary in order to effect the final stages of the lytic cycle.

The three-dimensional structures of Cro and of the lambda repressor protein have been determined by x-ray crystallography, and models for their binding and effecting the above-described molecular and genetic events have been proposed and tested. Both bind to DNA using helix-turn-helix DNA-binding domain (DBD) motifs (see below). To date, this system provides arguably the best understanding of the molecular events involved in gene activation and repression.

Detailed analysis of the lambda repressor led to the important concept that transcription regulatory proteins have several functional domains. For example, lambda repressor binds to DNA with high affinity. Repressor monomers form dimers, cooperatively interact with each other, and repressor interacts with RNA polymerase, to enhance or block promoter binding or RNAP open complex formation (see Figure 36–3). The protein–DNA interface and the three protein–protein interfaces all involve separate and distinct domains of the repressor molecule. As will be noted below (see Figure 38–19), this is a characteristic shared by most (perhaps all) molecules that regulate transcription.

SPECIAL FEATURES ARE INVOLVED IN REGULATION OF EUKARYOTIC GENE TRANSCRIPTION

Most of the DNA in prokaryotic cells is organized into genes, and since the DNA is not compacted with nucleosomal histones it always has the potential to be transcribed if appropriate positive and negative *trans*-factors are activated. A very different situation exists in eukaryotic cells where relatively little of the total DNA is organized into mRNA encoding genes and their associated regulatory regions. The function of the extra DNA is being actively investigated (ie, Chapter 39; the ENCODE Projects). More importantly, as described in Chapter 35, the DNA in eukaryotic cells is extensively folded and packed into the protein–DNA complex called chromatin. Histones are an important part of this complex since they both form the structures known as nucleosomes (see Chapter 35) and also factor significantly into gene regulatory mechanisms as outlined below.

The Chromatin Template Contributes Importantly to Eukaryotic Gene Transcription Control

Chromatin structure provides an additional level of control of gene transcription. As discussed in Chapter 35, large regions of chromatin are transcriptionally inactive while others are either active or potentially active. With few exceptions,

each cell contains the same complement of genes hence, the development of specialized organs, tissues, and cells, and their function in the intact organism depend upon the differential expression of genes.

Some of this differential expression is achieved by having different regions of chromatin available for transcription in cells from various tissues. For example, the DNA containing the β -globin gene cluster is in “**active**” **chromatin** in the reticulocyte but in “**inactive**” **chromatin** in muscle cells. All the factors involved in the determination of active chromatin have not been elucidated. The presence of nucleosomes and of complexes of histones and DNA (see Chapter 35) certainly provides a barrier against the ready association of transcription factors with specific DNA regions. The dynamics of the formation and disruption of nucleosome structure are therefore an important part of eukaryotic gene regulation.

Histone covalent modification, also dubbed the **histone code**, is an important determinant of gene activity. Histones are subjected to a wide range of specific posttranslational modifications (see Table 35–1). These modifications are dynamic and reversible. Histone acetylation and deacetylation are best understood. The surprising discovery that histone acetylase and other enzymatic activities are associated with the coregulators involved in regulation of gene transcription (see Chapter 42) has provided a new concept of gene regulation. Acetylation is known to occur on lysine residues in the amino terminal tails of histone molecules, and has been consistently correlated with transcription, or alternatively, transcriptional potential. Histone acetylation reduces the positive charge of these tails and likely contributes to a decrease in the binding affinity of histone for the negatively charged DNA. Moreover, such covalent modification of the histones creates new binding sites for additional proteins such as ATP-dependent chromatin remodeling complexes that contain subunits that carry structural domains that specifically bind to histones that have been subjected to coregulator-deposited PTMs. These complexes can increase accessibility of adjacent DNA sequences by removing nucleosomal histones. Together then coregulators (chromatin modifiers and chromatin remodellers), working in conjunction, can open up gene promoters and regulatory regions, facilitating binding of other *trans*-factors and RNA polymerase II and GTFs (see Figures 36–10 and 36–11). Histone deacetylation catalyzed by transcriptional corepressors would have the opposite effect. Different proteins with specific acetylase and deacetylase activities are associated with various components of the transcription apparatus. The proteins that catalyze the histone PTMs are sometimes referred to as “**code writers**” while the proteins that recognize, bind and thus interpret these histone PTMs are termed “**code readers**” and the enzymes that remove histone PTMs are called “**code erasers**.” Collectively then, these histone PTMs represent a very dynamic, potentially information-rich source of regulatory information. The exact rules and mechanisms defining the specificity of these various processes are under investigation. Some specific examples are illustrated in Chapter 42. A variety of commercial enterprises are working to develop

drugs that specifically alter the activity of the proteins that orchestrate the histone code.

As described in Chapter 35 there is evidence that the **methylation of deoxycytidine residues, 5MeC**, (in the sequence 5'-^mCpG-3') in DNA may effect changes in chromatin so as to preclude its active transcription. For example, in mouse liver, only the unmethylated ribosomal genes can be expressed, and there is evidence that many animal viruses are not transcribed when their DNA is methylated. Acute demethylation of 5MeC residues in specific regions of steroid hormone inducible genes has been associated with an increased rate of transcription of the gene. However, it is not yet possible to generalize that methylated DNA is transcriptionally inactive, that all inactive chromatin is methylated, or that active DNA is not methylated.

Finally, the binding of specific transcription factors to cognate DNA elements may result in disruption of nucleosomal structure. Most eukaryotic genes have multiple protein-binding DNA elements. The serial binding of transcription factors to these elements—in a combinatorial fashion—may either directly disrupt the structure of the nucleosome, prevent its re-formation, or recruit, via protein-protein interactions, multiprotein coregulator complexes that have the ability to covalently modify and/or remodel nucleosomes. These reactions result in chromatin-level structural changes that in the end increase or decrease DNA accessibility to other factors and the transcription machinery.

Eukaryotic DNA that is in an “active” region of chromatin can be transcribed. As in prokaryotic cells, a **promoter** dictates where the RNA polymerase will initiate transcription, but the promoter in mammalian cells (see Chapter 36) is more complex. Additional complexity is added by elements or factors that enhance or repress transcription, define tissue-specific expression, and modulate the actions of many effector molecules. Finally, recent results suggest that gene activation and repression might occur when particular genes move into or out of different subnuclear compartments or locations.

Epigenetic Mechanisms Contribute Importantly to the Control of Gene Transcription

The molecules and regulatory biology described above contributes importantly to transcriptional regulation. Indeed, in recent years the role of covalent modification of DNA and histone (and nonhistone) proteins and the newly discovered ncRNAs has received tremendous attention in the field of gene regulation research, particularly through investigation into how such chemical modifications and/or molecules stably alter gene expression patterns without altering the underlying DNA gene sequence. This field of study has been termed **epigenetics**. As mentioned in Chapter 35, one aspect of these mechanisms, PTMs of histones has been dubbed the **histone code** or histone epigenetic code. The term “epigenetics” means “above genetics” and refers to the fact that these regulatory mechanisms do not change the underlying regulated DNA

sequence, but rather simply the expression patterns of this DNA. Epigenetic mechanisms play key roles in the establishment, maintenance, and reversibility of transcriptional states. A key feature of epigenetic mechanisms is that the controlled transcriptional on/off states can be maintained through multiple rounds of cell division. This observation indicates that there must be robust mechanisms to maintain and stably propagate these epigenetic states.

Two forms of epigenetic signals, *cis*- and *trans*-epigenetic signals, can be described; these are schematically illustrated in **Figure 38–8**. A simple *trans*-signaling event composed of positive transcriptional feedback mediated by an abundant, diffusible transactivator that partitions between mother and daughter cell at each division is depicted in Figure 38–8A. So long as the indicated, transcription factor is expressed at a sufficient level to allow all subsequent daughter cells to inherit the *trans*-epigenetic signal (transcription factor), such cells will have the cellular or molecular phenotype dictated by the other target genes of this transcriptional activator. Shown in Figure 38–8 panel B is an example of how a *cis*-epigenetic signal (here as a specific 5MeCpG methylation mark) can be stably propagated to the two daughter cells following cell division. The hemi-methylated (ie, only one of the two DNA strands is 5MeC modified) DNA mark generated during DNA replication directs the methylation of the newly replicated strand through the action of ubiquitous maintenance DNA methylases. This 5MeC methylation results in both DNA daughter strands having the complete *cis*-epigenetic mark.

Both *cis*- and *trans*-epigenetic signals can result in stable and heritable expression states, and therefore generally represent type C gene expression responses (ie, Figure 38–1). However, it is important to note that both states can be reversed if either the *trans*- or *cis*-epigenetic signals are removed by, for example, extinguishing the expression of the enforcing transcription factor (*trans*-signal) or by completely removing a DNA *cis*-epigenetic signal (via DNA demethylation). Enzymes have been described that can remove both protein PTMs and 5MeC modifications.

Stable transmission of epigenetic on/off states can be effected by multiple molecular mechanisms. Shown in **Figure 38–9** are three ways by which *cis*-epigenetic marks can be propagated through a round of DNA replication. The first example of epigenetic mark transmission involves the propagation of DNA 5MeC marks, and occurs as described above in Figure 38–8. The second example of epigenetic state transmission illustrates how a nucleosomal histone PTM (in this example, Lysine K-27 trimethylated histone H3; H3K27me3) can be propagated. In this example immediately following DNA replication, both H3K27me3-marked and H3-unmarked nucleosomes randomly reform on both daughter DNA strands. The polycomb repressive complex 2 (PRC2), composed of EED-SUZ12-EZH2 and RbAP subunits, binds to the nucleosome containing the preexisting H3K27me3 mark via the EED subunit. Binding of PRC2 to this histone mark stimulates the methylase activity of the EZH2 subunit of PRC2, which results in the local methylation

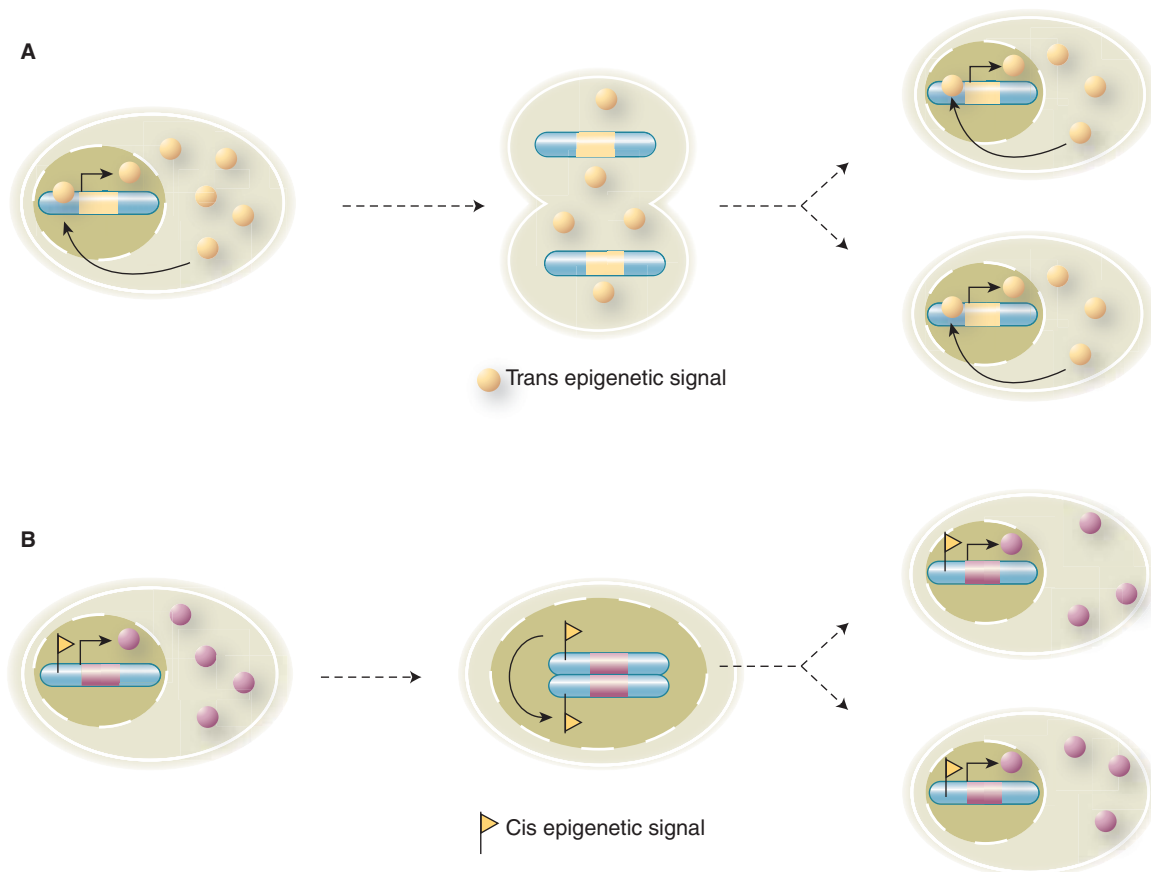

FIGURE 38-8 *cis-* and *trans-*epigenetic signals. **(A)** An example of an epigenetic signal that acts in *trans*. A DNA binding transactivator protein (yellow circle) is transcribed from its cognate gene (yellow bar) located on a particular chromosome (blue). The expressed protein is freely diffusible between nuclear and cytoplasmic compartments. Note that excess transactivator reenters the nucleus following cell division, binds to its own gene and activates transcription in both daughter cells. This cycle reestablishes the positive feedback loop in effect prior to cell division, and thereby enforces stable expression of this transcriptional activator protein in both cells. **(B)** A *cis*-epigenetic signal; a gene (pink) located on a particular chromosome (blue) carries a *cis*-epigenetic signal (small yellow flag) within the regulatory region upstream of the pink gene transcription unit. In this case, the epigenetic signal is associated with active gene transcription and subsequent gene product production (pink circles). During DNA replication, the newly replicated chromatid serves as a template that both elicits and templates the introduction of the same epigenetic signal, or mark, on the newly synthesized, unmarked chromatid. Consequently, both daughter cells contain the pink gene in a similarly *cis*-epigenetically marked state, which ensures expression in an identical fashion in both cells. See text for more detail. (Image taken from: Roberto Bonasio, R, Tu, S, Reinberg D: Molecular signals of epigenetic states. *Science* 2010;330:612–616. Reprinted with permission from AAAS.)

of nucleosomal H3. Histone H3 methylation thus causes the full, stable transmission of the H3K27me3 epigenetic mark to both chromatids. Finally, locus/sequence-specific targeting of nucleosomal histone epigenetic *cis*-signals can be attained through the action of lncRNAs as depicted in Figure 38-9, panel C. Here a specific ncRNA interacts with target DNA sequences and the resulting RNA-DNA complex is recognized by RBP, an RNA-binding protein. Then, likely through a specific adaptor protein (A), the RNA-DNA-RBP complex recruits a chromatin modifying complex (CMC) that locally modifies nucleosomal histones. Again, this mechanism leads to the transmission of a stable epigenetic mark.

Additional work will be required to establish the complete molecular details of these epigenetic processes, determine how ubiquitously these mechanisms operate, identify the full

complement of molecules involved, and genes controlled. Epigenetic signals are critically important to gene regulation as evidenced by the fact that mutations and/or overexpression of many of the molecules that contribute to epigenetic control lead to human disease.

Certain DNA Elements Enhance or Repress Transcription of Eukaryotic Genes

In addition to gross changes in chromatin affecting transcriptional activity, certain DNA elements facilitate or enhance initiation at the promoter and hence are termed **enhancers**. Enhancer elements, which typically contain multiple binding sites for transactivator proteins, differ from the promoter in notable ways. They can exert their positive influence on

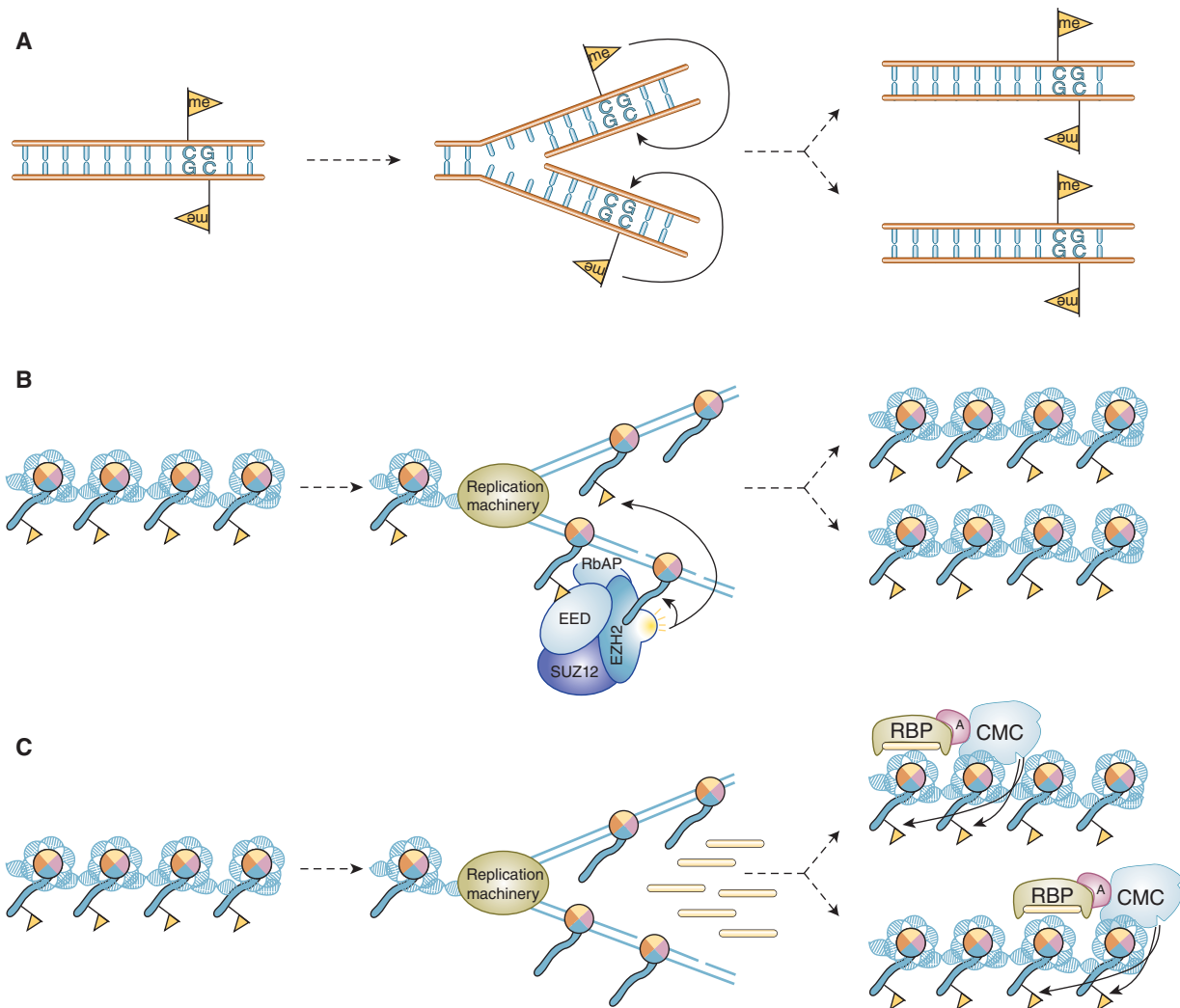

FIGURE 38-9 Mechanisms for the transmission and propagation of epigenetic signals following a round of DNA replication. **(A)** Propagation of a 5MeC signal (yellow flag; see Figure 38-8B). **(B)** Propagation of a histone PTM epigenetic signal (H3K27me) that is mediated through the action of the PRC2, a chromatin modifying complex, or CMC. PRC2 is composed of EED, EZH2 histone methylase, RbAP and SUZ12 subunits. Note that in this context PRC2 is a both a histone code reader (via the methylated histone binding domain in EED) and histone code writer (via the SET domain histone methylase within EZH2). Location-specific deposition of the histone PTM *cis*-epigenetic signal is targeted by the recognition of the H3K27me marks in preexisting nucleosomal histones (yellow flag). **(C)** Another example of the transmission of a histone epigenetic signal (yellow flag) except here signal-targeting is mediated through the action of small ncRNAs that work in concert with an RNA-binding protein (RBP), an Adaptor (A) protein, and a CMC. See text for more detail. (Image taken from: Roberto Bonasio, R, Tu, S, Reinberg D: Molecular signals of epigenetic states. *Science* 2010;330:612–616. Reprinted with permission from AAAS.)

transcription even when separated by tens of thousands of base pairs from a promoter; they work when oriented in either direction; and they can work upstream (5') or downstream (3') from the promoter. Enhancers are promiscuous; they can stimulate any promoter in the vicinity and may act on more than one promoter. The viral SV40 enhancer can exert an influence on, for example, the transcription of β -globin by increasing its transcription 200-fold in cells containing both the SV40 enhancer and the β -globin gene on the same plasmid (see below and **Figure 38-10**); in this case the SV40 enhancer β -globin gene was constructed using recombinant DNA technology—see Chapter 39. The enhancer element does not produce a product that in turn acts on the promoter, since it is

active only when it exists within the same DNA molecule as (ie, in *cis*, or physically linked to) the promoter. Enhancer-binding proteins are responsible for this effect. The exact mechanisms by which these transcription activators work are subject to intensive investigation. Enhancer-binding *trans*-factors have been shown to interact with a plethora of other transcription proteins. These interactions include chromatin-modifying co-activators, Mediator, as well as the individual components of the basal RNA polymerase II transcription machinery. Ultimately, transfactor-enhancer DNA-binding events result in an increase in the binding and/or activity of the basal transcription machinery on the linked promoter. Enhancer elements and associated binding proteins often

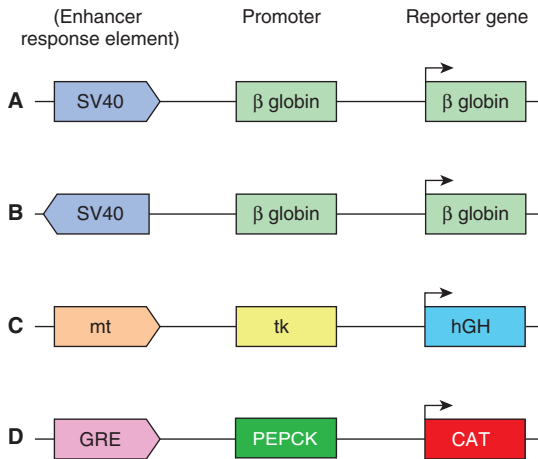

FIGURE 38-10 A schematic illustrating the methods used to study the organization and action of enhancers and other *cis*-acting regulatory elements. These model chimeric genes, all constructed by recombinant DNA techniques *in vitro* (Chapter 39), consist of a reporter gene that encodes a protein that can be readily assayed, and that is not normally produced in the cells to be studied, a promoter that ensures accurate initiation of transcription, and the indicated enhancers (regulatory response) elements. In all cases, high-level transcription from the indicated chimeras depends upon the presence of enhancers, which stimulate transcription ≥ 100 -fold over basal transcriptional levels (ie, transcription of the same chimeric genes containing just promoters fused to the indicated reporter genes). Examples (A) and (B) illustrate the fact that enhancers (eg, here SV40) work in either orientation and upon a heterologous promoter. Example (C) illustrates that the metallothionein (*mt*) regulatory element (which under the influence of cadmium or zinc induces transcription of the endogenous *mt* gene and hence the metal-binding *mt* protein) will work through the *Herpes simplex virus* (HSV) thymidine kinase (*tk*) gene promoter to enhance transcription of the human growth hormone (*hGH*) reporter gene. This engineered genetic construct was introduced into the male pronuclei of single-cell mouse embryos and the embryos placed into the uterus of a surrogate mother to develop as transgenic animals. Offspring have been generated under these conditions, and in some the addition of zinc ions to their drinking water effects an increase in growth hormone expression in liver. In this case, these transgenic animals have responded to the high levels of growth hormone by becoming twice as large as their normal litter mates. Example (D) illustrates that a glucocorticoid response element (GRE) enhancer will work through homologous (*PEPCK* gene) or heterologous gene promoters (not shown; ie, HSV *tk*) promoter, SV40 promoter, β -globin promoter, etc) to drive expression of the chloramphenicol acetyl transferase (*CAT*) reporter gene.

convey nuclease hypersensitivity to those regions where they reside (Chapter 35). A summary of the properties of enhancers is presented in **Table 38-2**.

One of the best-understood mammalian enhancer systems is that of the β -interferon gene. This gene is induced upon viral infection of mammalian cells. One goal of the cell, once virally infected, is to attempt to mount an antiviral response—if not to save the infected cell, then to help to save the entire organism from viral infection. Interferon production is one mechanism by which this is accomplished. This family of proteins is secreted by virally infected cells. Secreted interferon interacts with neighboring cells to cause an inhibition of viral replication

TABLE 38-2 Summary of the Properties of Enhancers

- | |
|--|
| • Work when located long distances from the promoter |
| • Work when upstream or downstream from the promoter |
| • Work when oriented in either direction |
| • Can work with homologous or heterologous promoters |
| • Work by binding one or more proteins |
| • Work by recruiting chromatin-modifying coregulatory complexes |
| • Work by facilitating binding of the basal transcription complex to the <i>cis</i> -linked promoter |

by a variety of mechanisms, thereby limiting the extent of viral infection. The enhancer element controlling induction of the β -interferon gene, which is located between nucleotides -110 and -45 relative to the transcription start site ($+1$), is well characterized. This enhancer consists of four distinct clustered *cis*-elements, each of which is bound by unique *trans*-factors. One *cis*-element is bound by the transacting factor NF- κ B (see Figures 42-10 and 42-13) one by a member of the IRF (interferon regulatory factor) family of transactivator-factors, and a third by the heterodimeric leucine zipper factor ATF-2/*c-Jun* (see below). The fourth factor is the ubiquitous, abundant architectural transcription factor known as HMG I(Y). Upon binding to its A+T-rich binding sites, HMG I(Y) induces a significant bend in the DNA. There are four such HMG I(Y) binding sites interspersed throughout the enhancer. These sites play a critical role in forming a particular 3D structure, along with the aforementioned three *trans*-factors, by inducing a series of critically spaced DNA bends. Consequently, HMG I(Y) induces the cooperative formation of a unique, stereospecific, 3D structure within which all four factors are active when viral infection signals are sensed by the cell. The structure formed by the cooperative assembly of these four factors is termed the β -interferon enhanceosome (see **Figure 38-11**), so named because of its obvious structural similarity to the nucleosome, which is also a unique three-dimensional protein-DNA structure that wraps DNA about a core assembly of proteins (see Figures 35-1 and 35-2). The enhanceosome, once formed, induces a large increase in β -interferon gene transcription upon virus infection. It is not simply the protein occupancy of the linearly apposed *cis*-element sites that induces β -interferon gene transcription—rather, it is the formation of the enhanceosome proper that provides appropriate surfaces for the recruitment of coactivators that results in the enhanced formation of the PIC on the *cis*-linked promoter and thus transcription activation.

The *cis*-acting elements that decrease or **repress/silence** the expression of specific genes have also been identified. Because fewer of these elements have been studied, it is not possible to formulate generalizations about their mechanism of action—though again, as for gene activation, chromatin level covalent modifications of histones and other proteins by repressor-recruited multisubunit corepressors have been implicated.

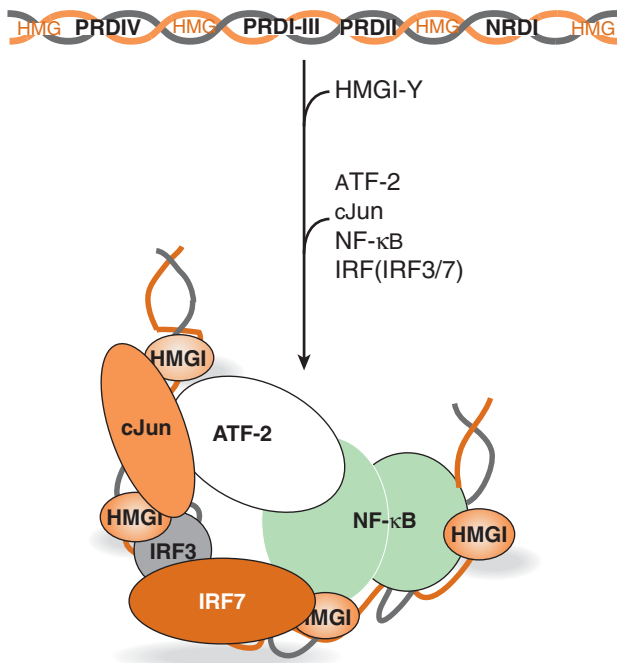

FIGURE 38–11 Formation and putative structure of the enhaneosome formed on the human β -interferon gene enhancer. Diagrammatically represented at the top is the distribution of the multiple *cis*-elements (HMG, PRDIV, PRDI-III, PRDII, NRDI) composing the β -interferon gene enhancer. The intact enhancer mediates transcriptional induction of the β -interferon gene (*IFNB1*) over 100-fold upon virus infection of human cells. The *cis*-elements of this modular enhancer represent the binding sites for the *trans*-factors HMG I(Y), cJun-ATF-2, IRF3-IRF7 and NF- κ B, respectively. The factors interact with these DNA elements in an obligatory, ordered, and highly cooperative fashion as indicated by the arrow. Initial binding of four HMG I(Y) proteins induces sharp DNA bends in the enhancer, causing the entire 70 to 80 bp region to assume a high level of curvature. This curvature is integral to the subsequent highly cooperative binding of the other *trans*-factors since bending enables the DNA-bound factors to make critical direct protein-protein interactions that both contribute to the formation and stability of the enhaneosome and generate a unique 3D surface that serves to recruit chromatin-modifying coregulators that carry enzymatic activities (eg, Swi/Snf: ATPase, chromatin remodeler and P/CAF: histone acetyltransferase) as well as the general transcription machinery (RNA polymerase II and GTFs). Although four of the five *cis*-elements (PRDIV, PRDI-III, PRDII, NRDI) independently can modestly stimulate (~10-fold) transcription of a reporter gene in transfected cells (see Figures 38–10 and 38–12), all five *cis*-elements, in appropriate order, are required to form an enhancer that can appropriately stimulate transcription of *IFNB1* (ie, ≥ 100 -fold) in response to viral infection of a human cell. This distinction indicates the strict requirement for appropriate enhaneosome architecture for efficient *trans*-activation. Similar enhaneosomes, involving distinct *cis*- and *trans*-factors and coregulators, are proposed to form on many other mammalian genes.

Tissue-Specific Expression May Result From Either the Action of Enhancers or Repressors or a Combination of Both *Cis*-Acting Regulatory Elements

Many thousands of genes are now recognized to harbor enhancer elements in various locations relative to their coding regions. In addition to being able to enhance gene transcription, some of these enhancer elements clearly possess the ability to do so in

a tissue-specific manner. By fusing known or suspected tissue-specific enhancers to reporter genes (see below) and introducing these chimeric enhancer-reporter constructs via microinjection into single-cell embryos, one can create a transgenic animal (see Chapter 39), and rigorously test whether a given test enhancer or silencers truly modulates expression in a cell- or tissue-specific fashion. This **transgenic animal** approach has proved useful in studying tissue-specific gene expression.

Reporter Genes Are Used to Define Enhancers & Other Regulatory Elements That Modulate Gene Expression

By ligating regions of DNA suspected of harboring regulatory sequences to various reporter genes (the **reporter** or **chimeric gene approach**) (Figures 38–10, 38–12, and 38–13), one can

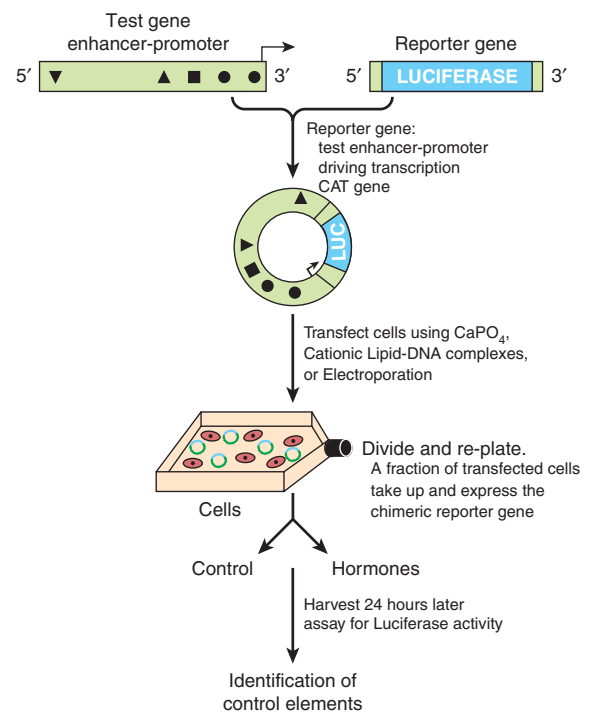

FIGURE 38–12 The use of reporter genes to define DNA regulatory elements. A DNA fragment bearing regulatory *cis*-elements (triangles, square, circles in diagram) from the gene in question—in this example, approximately 2 kb of 5′-flanking DNA and cognate promoter—is ligated into a plasmid vector that contains a suitable reporter gene—in this case, the enzyme firefly luciferase, abbreviated LUC. As noted in Figure 38–10 in such experiments, the reporter cannot be present endogenously in the cells transfected. Consequently, any detection of these activities in a cell extract means that the cell was successfully transfected by the plasmid. Not shown here, but typically one cotransfects an additional reporter such as Renilla luciferase to serve as a transfection efficiency control. Assay conditions for the firefly and Renilla luciferases are different, hence the two activities can be sequentially assayed using the same cell extract. An increase of firefly luciferase activity over the basal level, for example, after addition of one or more hormones, means that the region of DNA inserted into the reporter gene plasmid contains functional hormone response elements (HRE). Progressively shorter pieces of DNA, regions with internal deletions, or regions with point mutations can be constructed and inserted upstream of the reporter gene to pinpoint the response element (see Figure 38–13).

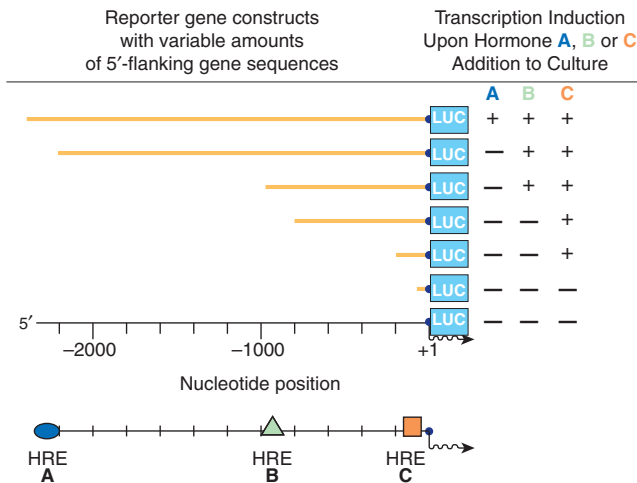

FIGURE 38-13 Mapping distinct hormone response elements (HREs) (A), (B), and (C) using the reporter gene-transfection approach. A family of reporter genes, constructed as described in Figures 38-10 and 38-12, can be transfected individually into a recipient cell. By analyzing when certain hormone responses are lost in comparison to the 5' deletion end point, specific hormone-response enhancer elements can be located and defined, ultimately with nucleotide-level precision.

determine which regions in the vicinity of structural genes have an influence on their expression. Pieces of DNA thought to harbor regulatory elements, often identified by bioinformatic sequence alignments, are ligated to a suitable reporter gene and introduced into a host cell (Figure 38-12). Basal expression of the reporter gene will be increased if the DNA contains an enhancer. Addition of a hormone or heavy metal to the culture medium will increase expression of the reporter gene if the DNA contains a hormone (HRE) or metal response (MRE) element (Figure 38-13). The location of the element can be pinpointed by using progressively shorter pieces of DNA, deletions, or point mutations (Figure 38-13).

This strategy, typically **using transfected cells in culture** (ie, cells induced to take up exogenous DNAs), has led to the identification of hundreds of enhancers, silencers/repressors such as tissue-specific elements, and hormone, heavy metal, and drug-response elements. The activity of a gene at any moment reflects the interaction of these numerous *cis*-acting DNA elements with their respective *trans*-acting factors. Overall, transcriptional output is determined by the balance of positive and negative signaling to the transcription machinery. The challenge now is to figure out exactly how this regulation occurs at the molecular level so that we might ultimately have the ability to modulate gene transcription in a therapeutic context.

Combinations of DNA Elements & Associated Proteins Provide Diversity in Responses

Prokaryotic genes are often regulated in an on-off manner in response to simple environmental cues. Some eukaryotic genes are regulated in the simple on-off manner, but

the process in most genes, especially in mammals, is much more complicated. Signals representing a number of complex environmental stimuli may converge on a single gene. The response of the gene to these signals can have several physiologic characteristics. First, the response may extend over a considerable range. This is accomplished by having additive and synergistic positive responses counterbalanced by negative or repressing effects. In some cases, either the positive or the negative response can be dominant. Also required is a mechanism whereby an effect or such as a hormone can activate some genes in a cell while repressing others and leaving still others unaffected. When all of these processes are coupled with tissue-specific element factors, considerable flexibility is afforded. These physiologic variables obviously require an arrangement much more complicated than an on-off switch. The collection and organization of DNA elements in a promoter specifies—via associated factors—how a given gene will respond, and how long a particular response is maintained. Some simple examples are illustrated in Figure 38-14.

Transcription Domains Can Be Defined by Locus Control Regions & Insulators

The large number of genes in eukaryotic cells and the complex arrays of transcription regulatory factors present an organizational problem. Why are some genes available for

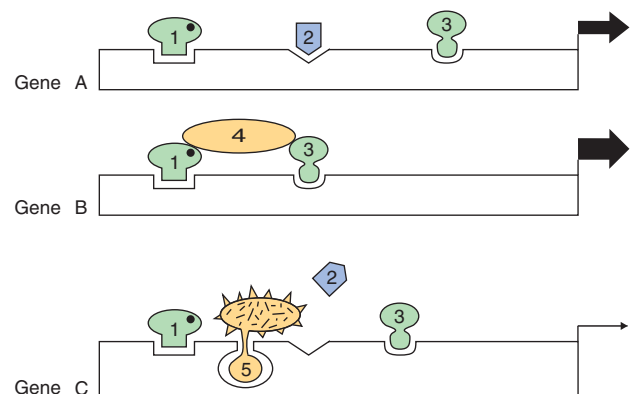

FIGURE 38-14 Combinations of DNA elements and proteins provide diversity in the response of a gene. Gene A is activated (the width of the arrow indicates the extent) by the combination of transcriptional activator proteins 1, 2, and 3 (probably with coactivators, as shown in Figures 36-10 and 38-11). Gene B is activated, in this case more effectively, by the combination of factors one, three, and four; note that transcription factor 4 does not contact DNA directly in this example. The activators could form a linear bridge that links the basal machinery to the promoter, or alternatively, this could be accomplished by DNA looping. In either case, the purpose is to direct the basal transcription machinery to the promoter. Gene C is inactivated by the combination of transcription factors 1, 5, and 3; in this case, factor 5 is shown to preclude the essential binding of factor 2 to DNA, as occurs in example A. If activator 1 promotes cooperative binding of repressor protein 5, and if activator 1 promotes cooperative binding of repressor protein 5, and if activator 1 promotes cooperative binding of repressor protein 5, and if activator 1 promotes cooperative binding of repressor protein 5, it can be seen how the ligand could activate one gene in a cell (gene A) and repress another (gene C) in the same cell.

transcription in a given cell whereas others are not? If enhancers can regulate several genes from tens of kilobase distances and are not position- and orientation-dependent, how are they prevented from triggering transcription of all *cis*-linked genes in the vicinity? Part of the solution to these problems is arrived at by having the chromatin arranged in functional units that restrict patterns of gene expression. This may be achieved by having the chromatin form a structure with the nuclear matrix or other physical entity or compartment, within the nucleus. Alternatively, some regions are controlled by complex DNA elements called **locus control regions (LCRs)**. An LCR—with associated bound proteins—controls the expression of a cluster of genes. The best-defined LCR regulates expression of the globin gene family over a large region of DNA. Another mechanism is provided by **insulators**. These DNA elements, also in association with one or more proteins, prevent an enhancer from acting on a promoter on the other side of an insulator in another transcription domain. Insulators thus serve as transcriptional **boundary elements**.

SEVERAL MOTIFS COMPOSE THE DNA BINDING DOMAINS OF REGULATORY TRANSCRIPTION FACTOR PROTEINS

The specificity involved in the control of transcription requires that regulatory proteins bind with high affinity and specificity to the correct region of DNA. Three unique motifs—the **helix-turn-helix**, the **zinc finger**, and the **leucine zipper**—account for many of these specific protein-DNA interactions. Examples of proteins containing these motifs are given in **Table 38–3**.

TABLE 38–3 Examples of Transcription Factors That Contain Various DNA Binding Motifs

Binding Motif	Organism	Regulatory Protein
Helix-turn-helix	<i>E coli</i>	lac repressor, CAP
	Phage	λ cl, cro, and 434 repressors
	Mammals	Homeobox proteins Pit-1, Oct1, Oct2
Zinc finger	<i>E coli</i>	Gene 32 protein
	Yeast	Gal4
	<i>Drosophila</i>	Serendipity, hunchback
	Xenopus	TFIIIA
	Mammals	Steroid receptor family, Sp1
Leucine zipper	Yeast	GCN4
	Mammals	C/EBP, fos, Jun, Fra-1, CRE binding protein (CREB), c-myc, n-myc, l-myc

Comparison of the binding activities of the proteins that contain these motifs leads to several important generalizations.

1. Binding must be of high affinity to the specific site and of low affinity to other DNA.
2. Small regions of the protein make direct contact with DNA; the rest of the protein, in addition to providing the *trans*-activation domains, may be involved in the dimerization of monomers of the binding protein, may provide a contact surface for the formation of heterodimers, may provide one or more ligand-binding sites, or may provide surfaces for interaction with coactivators, corepressors or the transcription machinery.
3. The protein-DNA interactions made by these proteins are maintained by hydrogen bonds, ionic interactions and van der Waals forces.
4. The motifs found in these proteins are class-specific; their presence in a protein of unknown function suggests that the protein may bind to DNA.
5. Proteins with the helix-turn-helix or leucine zipper motifs form dimers, and their respective DNA-binding sites are symmetric palindromes. In proteins with the zinc finger motif, the binding site is repeated two to nine times. These features allow for cooperative interactions between binding sites and enhance the degree and affinity of binding.

The Helix-Turn-Helix Motif

The first motif described was the **helix-turn-helix**. Analysis of the 3D structure of the lambda Cro transcription regulator has revealed that each monomer consists of three antiparallel β sheets and three α helices (**Figure 38–15**). The dimer forms by association of the antiparallel β_3 sheets. The α_3 helices form the DNA recognition surface, and the rest of the molecule appears to be involved in stabilizing these structures. The average diameter of an α helix is 1.2 nm, which is the approximate width of the major groove in the B form of DNA.

The DNA recognition domain of each Cro monomer interacts with 5 bp and the dimer binding sites span 3.4 nm, allowing fit into successive half turns of the major groove on the same surface (**Figure 38–15**). X-ray analyses of the λ cI repressor, CAP (the cAMP receptor protein of *E coli*), tryptophan repressor, and phage 434 repressor, all also display this dimeric helix-turn-helix structure that is present in eukaryotic DNA-binding proteins as well (see **Table 38–3**).

The Zinc Finger Motif

The **zinc finger** was the second DNA binding motif whose atomic structure was elucidated. It was known that the protein TFIIIA, a positive regulator of 5S RNA gene transcription, required zinc for activity. Structural and biophysical analyses revealed that each TFIIIA molecule contains nine zinc ions in a repeating coordination complex formed by closely

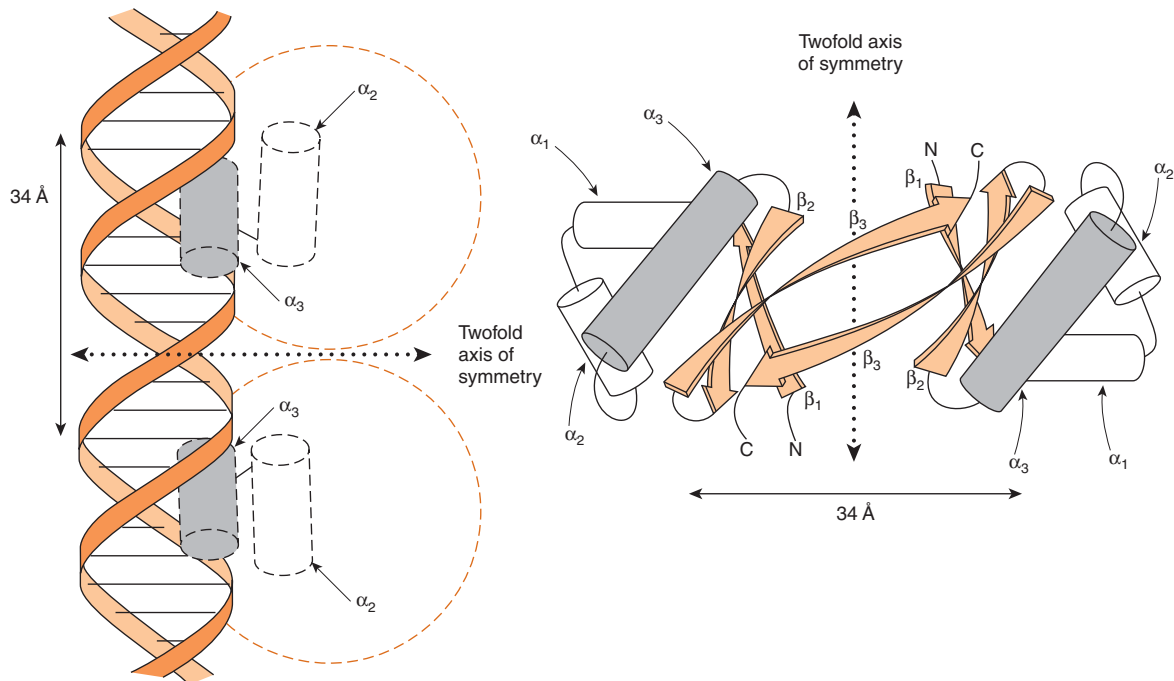

FIGURE 38-15 A schematic representation of the 3D structure of Cro protein and its binding to DNA by its helix-turn-helix motif (left). The Cro monomer consists of three antiparallel β sheets (β_1 - β_3) and three α -helices (α_1 - α_3). The helix-turn-helix (HTH) motif is formed because the α_3 and α_2 helices are held at about 90° to each other by a turn of four amino acids. The α_3 helix of Cro is the DNA recognition surface (shaded). Two monomers associate through interactions between the two antiparallel β_3 sheets to form a dimer that has a twofold axis of symmetry (right). A Cro dimer binds to DNA through its α_3 helices, each of which contacts about 5 bp on the same face of the major groove (see Figures 34-2 and 38-6). The distance between comparable points on the two DNA α -helices is 34 Å, the distance required for one complete turn of the double helix. (Courtesy of B Mathews.)

spaced cysteine-cysteine residues followed 12 to 13 amino acids later by a histidine-histidine pair (Figure 38-16). In some instances—notably the steroid-thyroid nuclear hormone receptor family—the His-His doublet is replaced by a second Cys-Cys pair. The zinc finger motifs of the protein lie on one face of the DNA helix, with successive fingers alternatively

positioned in one turn in the major groove. As is the case with the recognition domain in the helix-turn-helix protein, each TFIIIA zinc finger contacts about 5 bp of DNA. The importance of this motif in the action of steroid hormones is underscored by an “experiment of nature.” A single amino acid mutation in either of the two zinc fingers of the $1,25(\text{OH})_2\text{-D}_3$ receptor protein results in resistance to the action of this hormone and the clinical syndrome of rickets.

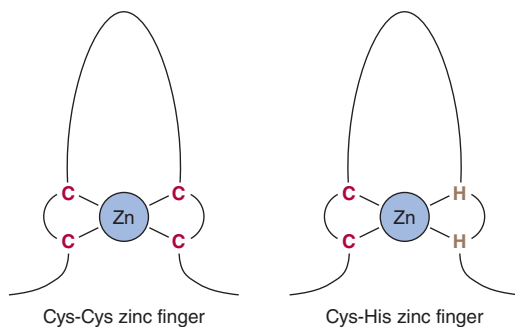

FIGURE 38-16 Zinc fingers are a series of repeated domains (two to nine) in which each is centered on a tetrahedral coordination with zinc. In the case of the DNA binding transcription factor TFIIIA, the coordination is provided by a pair of cysteine residues (C) separated by 12 to 13 amino acids from a pair of histidine (H) residues. In other zinc finger proteins, the second pair also consists of C residues. Zinc fingers bind in the major groove, with adjacent fingers making contact with 5 bp along the same face of the helix.

The Leucine Zipper Motif

Careful analysis of a 30-amino-acid sequence in the carboxyl terminal region of the enhancer binding protein C/EBP revealed a novel structure, the leucine zipper motif. As illustrated in Figure 38-17, this region of the protein forms an α helix in which there is a periodic repeat of leucine residues at every seventh position. This occurs for eight helical turns and four leucine repeats. Similar structures have been found in a number of other proteins associated with the regulation of transcription in mammalian and yeast cells. This structure allows two identical or nonidentical monomers (eg, Jun-Jun or Fos-Jun) to “zip together” in a coiled coil and form a tight dimeric complex (Figure 38-17). This protein-protein interaction may serve to enhance the association of the separate DBDs with their target (Figure 38-17).

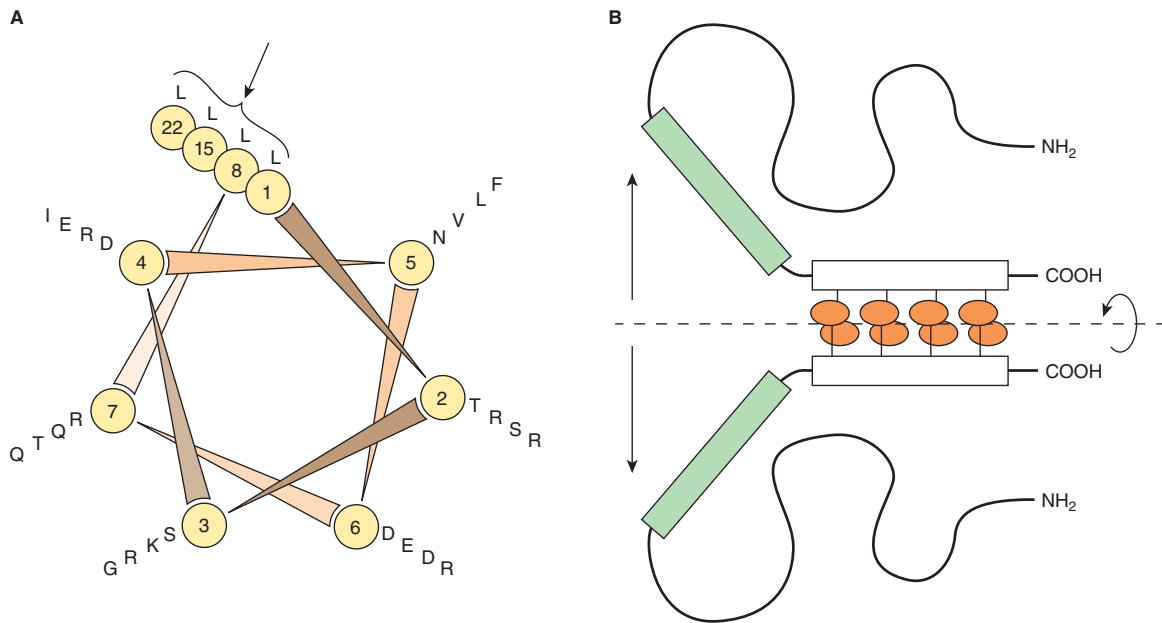

FIGURE 38-17 The leucine zipper motif. (A) Shown is a helical wheel analysis of a carboxyl terminal portion of the DNA binding protein C/EBP (Table 36-3). The amino acid sequence is displayed end-to-end down the axis of a schematic α -helix. The helical wheel consists of seven spokes that correspond to the seven amino acids that comprise every two turns of the α -helix. Note that leucine residues (L) occur at every seventh position (in this schematic C/EBP amino acid residues 1, 8, 15, 22; see arrow). Other proteins with “leucine zippers” have a similar helical wheel pattern. (B) A schematic model of the DNA-binding domain of C/EBP. Two identical C/EBP polypeptide chains are held in dimer formation by the leucine zipper domain of each polypeptide (denoted by the white rectangles and attached orange shaded ovals). This association is required to hold the DNA binding domains of each polypeptide (the green shaded rectangles) in the proper conformation and register for DNA binding. (Courtesy of S McKnight.)

THE DNA BINDING & TRANSACTIVATION DOMAINS OF MOST REGULATORY PROTEINS ARE SEPARATE

DNA binding could result in a general conformational change that allows the bound protein to activate transcription, or these two functions could be served by separate and independent domains. Domain swap experiments suggest that the latter is typically the case.

The *GAL1* gene product is involved in galactose metabolism in yeast. Transcription of this gene is positively regulated by the GAL4 protein, which binds to an upstream activator sequence (UAS), or enhancer, through an amino terminal domain. The amino terminal 73-amino-acid DBD of GAL4 was removed and replaced with the DBD of LexA, an *E coli* DNA-binding protein. This domain swap resulted in a molecule that did not bind to the *GAL1* UAS and, of course, did not activate the *GAL1* gene (Figure 38-18). If, however, the *lexA* operator—the DNA sequence normally bound by the *lexA* DBD—was inserted into the promoter region of the *GAL* gene thereby replacing the normal *GAL1* enhancer, the hybrid protein bound to this promoter (at the *lexA* operator) and it activated transcription of *GAL1*. This experiment, which has been repeated many times, demonstrates that the carboxyl terminal region of GAL4 contains a transcriptional activation domain. These data also demonstrate that the DBD and transactivation

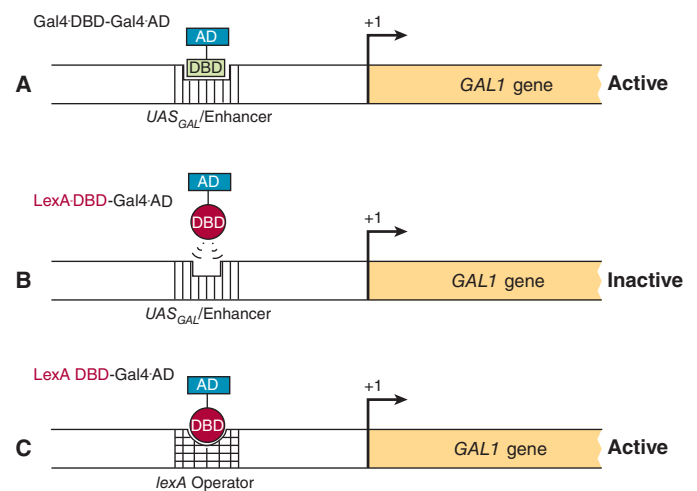

FIGURE 38-18 Domain-swap experiments demonstrate the independent nature of DNA binding and transcription activation domains. The yeast *GAL1* gene contains an upstream activating sequence (UAS) or enhancer that is bound by the regulatory transcription activation factor GAL4 (A). GAL4, like the lambda cI protein is modular, and contains an N-terminal DBD and an C-terminal activation domain, or AD. When the GAL4 transcription factor binds the *GAL1* UAS enhancer, activation of *GAL1* gene transcription ensues (Active). A chimeric protein, in which the amino terminal DNA-binding domain (DBD) of GAL4 is removed and replaced with the DBD of the *E coli* protein LexA, the resulting chimeric LexA DBD-GAL4 AD protein fails to stimulate *GAL1* transcription because the LexA DBD cannot bind to the *GAL1* enhancer/UAS (B). By contrast (C), the LexA DBD-GAL4 AD fusion protein does increase *GAL1* transcription when the *lexA* operator (the natural target for the LexA DBD) is inserted into the *GAL1* promoter region, replacing the normal *GAL1* UAS.

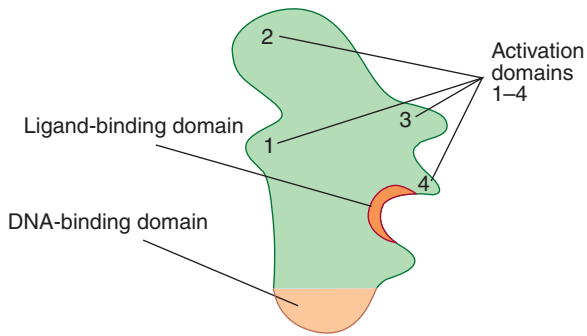

FIGURE 38–19 Proteins that regulate transcription have several domains. This hypothetical transcription factor has a DBD that is distinct from a ligand-binding domain (LBD) and several activation domains (ADs) (1–4). Other proteins may lack the DBD or LBD and all may have variable numbers of domains that contact other proteins, including coregulators and those of the basal transcription complex (see also Chapters 41 and 42).

domains (ADs) are independent. The hierarchy involved in assembling gene transcription-activating complexes includes proteins that bind DNA and transactivate; others that form protein-protein complexes which bridge DNA-binding proteins to transactivating proteins; and others that form protein-protein complexes with components of coregulators or the basal transcription apparatus. A given protein may thus have several modular surfaces or domains that serve different functions (Figure 38–19). (Not shown here, but DNA binding repressor proteins are organized similarly with separable DBD and silencing domains.) As described in Chapter 36, the primary purpose of these complex assemblies is to facilitate the assembly and/or activity of the basal transcription apparatus on the *cis*-linked promoter.

GENE REGULATION IN PROKARYOTES & EUKARYOTES DIFFERS IN IMPORTANT RESPECTS

In addition to transcription, eukaryotic cells employ a variety of mechanisms to regulate gene expression (Table 38–4). Many more steps, especially in RNA processing, are involved in the expression of eukaryotic genes than of prokaryotic genes, and these steps provide additional sites for regulatory influences that cannot exist in prokaryotes. These RNA processing steps in eukaryotes, described in detail in Chapter 36, include capping of the 5′ ends of the primary transcripts, addition of a polyadenylate tail to the 3′ ends of transcripts, and excision of intron regions to generate spliced exons in the mature mRNA molecule. To date, analyses of eukaryotic gene expression provide evidence that regulation occurs at the level of **transcription, nuclear RNA processing, mRNA stability, and translation**. In addition, **gene amplification and rearrangement influence gene expression**.

TABLE 38–4 Gene Expression Is Regulated by Transcription and in Numerous Other Ways at the RNA Level in Eukaryotic Cells

• Gene amplification
• Gene rearrangement
• RNA processing
• Alternate mRNA splicing
• Transport of mRNA from nucleus to cytoplasm
• Regulation of mRNA stability
• Compartmentalization
• ncRNA silencing and activation

Owing to the advent of recombinant DNA technology and high throughput DNA and RNA sequencing (Chapter 39), much progress has been made in recent years in the understanding of eukaryotic gene expression. However, because most eukaryotic organisms contain so much more genetic information than do prokaryotes and because manipulation of their genes is so much more difficult, molecular aspects of eukaryotic gene regulation are less well understood than the examples discussed earlier in this chapter. This section briefly describes a few different types of eukaryotic gene regulation.

ncRNAs Modulate Gene Expression by Altering mRNA Function

As noted in Chapter 35 the recently discovered class of ubiquitous eukaryotic noncoding RNAs, termed mi/siRNAs and lncRNAs contribute importantly to the control of gene expression. The mechanism of action of the small miRNA and siRNAs are best understood. These ~22 nucleotide RNAs regulate the function/expression of specific mRNAs by either inhibiting translation or inducing mRNA degradation via different mechanisms; in a very few cases miRNAs have been shown to stimulate mRNA function. At least a portion of the miRNA-driven modulation of mRNA activity is thought to occur in the **P body** (see Figure 37–11). miRNA action can result in dramatic changes in protein production and hence gene expression. These small ncRNAs have been implicated in numerous human diseases such as heart disease, cancer, muscle wasting, viral infection and diabetes.

miRNAs and siRNAs, like the DNA-binding transcription factors described in detail above, are transactive, and once synthesized and appropriately processed, interact with specific proteins and bind target mRNAs (see Figure 36–17). Binding of miRNAs to mRNA targets is directed by normal base-pairing rules. In general, if miRNA-mRNA base pairing has one or more mismatches, translation of the cognate “target” mRNA is inhibited, whereas if miRNA-mRNA base pairing is perfect over all 22 nucleotides, the corresponding mRNA is degraded.

Given the tremendous and ever growing importance of miRNAs, many scientists and biotechnology companies are

actively studying miRNA biogenesis, transport, and function in hopes of curing human disease. Time will tell the magnitude and universality of ncRNA-mediated gene regulation.

Eukaryotic Genes Can Be Amplified or Rearranged During Development or in Response to Drugs

During early development of metazoans, there is an abrupt increase in the need for specific molecules such as ribosomal RNA and messenger RNA molecules for proteins that make up specific cell or tissue types. One way to increase the rate at which such molecules can be formed is to increase the number of genes available for transcription of these specific molecules. Among the repetitive DNA sequences within the genome are hundreds of copies of ribosomal RNA genes. These genes preexist repetitively in the DNA of the gametes and thus are transmitted in high copy numbers from generation to generation. In some specific organisms such as the fruit fly (*Drosophila*), there occurs during oogenesis an amplification of a few preexisting genes such as those for the chorion (eggshell) proteins. Subsequently, these amplified genes, presumably generated by a process of repeated initiations during DNA synthesis, provide multiple sites for gene transcription (Figures 36–4 and 38–20). The dark side of specific gene amplification is the fact that in human cells drug resistance can develop upon extended therapeutic treatment due to the amplification and increased expression of genes that encode proteins that either degrade, or pump, drugs for target cells.

As noted in Chapter 36, the coding sequences responsible for the generation of specific protein molecules are frequently not contiguous in the mammalian genome. In the case of antibody encoding genes, this is particularly true. As described in detail in Chapter 52, immunoglobulins are composed of two polypeptides, the so-called heavy (about 50 kDa) and light (about 25 kDa) chains. The mRNAs encoding these two protein subunits are encoded by gene sequences that are subjected to extensive DNA sequence-coding changes. These DNA coding changes are integral to generating the requisite recognition diversity central to appropriate immune function.

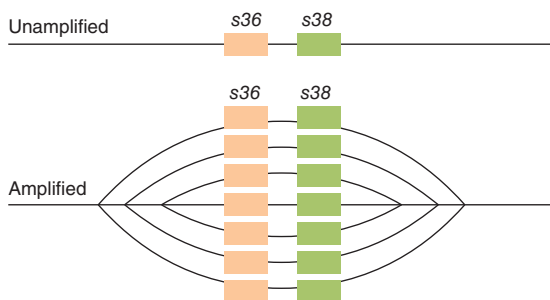

FIGURE 38–20 Schematic representation of the amplification of chorion protein genes *s36* and *s38*. (Reproduced, with permission, from Chisholm R: Gene amplification during development. Trends Biochem Sci 1982;7:161. Copyright © 1982. Reprinted, with permission, from Elsevier.)

IgG heavy and light chain mRNAs are encoded by several different segments that are tandemly repeated in the germline. Thus, for example, the IgG light chain consists of variable (V_L), joining (J_L), and constant (C_L) domains or segments. For particular subsets of IgG light chains, there are roughly 300 tandemly repeated V_L gene coding segments, 5 tandemly arranged J_L coding sequences, and roughly 10 C_L gene coding segments. All of these multiple, distinct coding sequences are located in the same region of the same chromosome, and each type of coding segment (V_L , J_L , and C_L) is tandemly repeated in head-to-tail fashion within the segment repeat region. By having multiple V_L , J_L , and C_L segments to choose from, an immune cell has a greater repertoire of sequences to work with to develop both immunologic flexibility and specificity. However, a given functional IgG light chain transcription unit—like all other “normal” mammalian transcription units—contains only the coding sequences for a single protein. Thus, before a particular IgG light chain can be expressed, *single* V_L , J_L , and C_L coding sequences must be recombined to generate a *single*, contiguous transcription unit excluding the multiple nonutilized segments (ie, the other approximately 300 unused V_L segments, the other 4 unused J_L segments, and the other 9 unused C_L segments). This deletion of unused genetic information is accomplished by selective DNA recombination that removes the unwanted coding DNA while retaining the required coding sequences: one V_L , one J_L , and one C_L sequence. (V_L sequences are subjected to additional point mutagenesis to generate even more variability—hence the name.) The newly recombined sequences thus form a single transcription unit that is competent for RNA polymerase II-mediated transcription into a single monocistronic mRNA. Although the IgG genes represent one of the best-studied instances of directed DNA rearrangement modulating gene expression, other cases of gene regulatory DNA rearrangement have been described in the literature.

Alternative RNA Processing Is Another Control Mechanism

In addition to affecting the efficiency of promoter utilization, eukaryotic cells employ alternative RNA processing to control gene expression. This can result when alternative promoters, intron-exon splice sites, or polyadenylation sites are used. Occasionally, heterogeneity within a cell results, but more commonly the same primary transcript is processed differently in different tissues. A few examples of each of these types of regulation are presented below.

The use of **alternative transcription start sites** results in a different 5′ exon on mRNAs encoding mouse amylase and myosin light chain, rat glucokinase, and *Drosophila* alcohol dehydrogenase and actin. **Alternative polyadenylation sites** in the μ immunoglobulin heavy chain primary transcript result in mRNAs that are either 2700 bases long (μ_m) or 2400 bases long (μ_s). This results in a different carboxyl terminal region of the encoded proteins such that the μ_m protein remains attached to the membrane of the B lymphocyte and the μ_s immunoglobulin

is secreted. **Alternative splicing and processing** results in the formation of seven unique α -tropomyosin mRNAs in seven different tissues. It is not clear how these processing-splicing decisions are made or whether these steps can be regulated.

Regulation of Messenger RNA Stability Provides Another Control Mechanism

Although most mRNAs in mammalian cells are very stable (half-lives measured in hours), some turn over very rapidly (half-lives of 10–30 minutes). In certain instances, mRNA stability is subject to regulation. This has important implications since there is usually a direct relationship between mRNA amount and the translation of that mRNA into its cognate protein. Changes in the stability of a specific mRNA can therefore have major effects on biologic processes.

Messenger RNAs exist in the cytoplasm as **ribonucleo-protein particles (RNPs)**. Some of these proteins protect the mRNA from digestion by nucleases, while others may under certain conditions promote nuclease attack. It is thought that mRNAs are stabilized or destabilized by the interaction of proteins with these various structures or sequences. Certain effectors, such as hormones, may regulate mRNA stability by increasing or decreasing the amount of these proteins.

It appears that the ends of mRNA molecules are involved in mRNA stability (**Figure 38–21**). The 5' cap structure in eukaryotic mRNA prevents attack by 5' exonucleases, and the poly(A) tail prohibits the action of 3' exonucleases. In mRNA molecules with those structures, it is presumed that a single endonucleolytic cut allows exonucleases to attack and digest the entire molecule. Other structures (sequences) in the 5' untranslated region (5' UTR), the coding region, and the 3' UTR are thought to promote or prevent this initial endonucleolytic action (**Figure 38–21**). A few illustrative examples will be cited.

Deletion of the 5' UTR results in a threefold to fivefold prolongation of the half-life of *c-myc* mRNA. Shortening the coding region of histone mRNA results in a prolonged half-life. A form of autoregulation of mRNA stability indirectly involves

the coding region. Free tubulin binds to the first four amino acids of a nascent chain of tubulin as it emerges from the ribosome. This appears to activate an RNase associated with the ribosome which then digests the tubulin mRNA.

Structures at the 3' end, including the poly(A) tail, enhance or diminish the stability of specific mRNAs. The absence of a poly(A) tail is associated with rapid degradation of mRNA, and the removal of poly(A) from some RNAs results in their destabilization. Histone mRNAs lack a poly(A) tail but have a sequence near the 3' terminal that can form a stem-loop structure, and this appears to provide resistance to exonucleolytic attack. Histone H4 mRNA, for example, is degraded in the 3'-5' direction but only after a single endonucleolytic cut occurs about nine nucleotides from the 3' end in the region of the putative stem-loop structure. Stem-loop structures in the 3' noncoding sequence are also critical for the regulation, by iron, of the mRNA encoding the transferrin receptor. Stem-loop structures are also associated with mRNA stability in bacteria, suggesting that this mechanism may be commonly employed.

Other sequences in the 3' ends of certain eukaryotic mRNAs appear to be involved in the destabilization of these molecules. Some of this is mediated through the action of specific miRNAs as discussed above. In addition, of particular interest are AU-rich regions, many of which contain the sequence AUUUA. This sequence appears in mRNAs that have a very short half-life, including some encoding oncogene proteins and cytokines. The importance of this region is underscored by an experiment in which a sequence corresponding to the 3' UTR of the short-half-life colony-stimulating factor (CSF) mRNA, which contains the AUUUA motif, was added to the 3' end of the β -globin mRNA. Instead of becoming very stable, this hybrid β -globin mRNA now had the short-half-life characteristic of CSF mRNA. Much of this mRNA metabolism likely occurs in cytoplasmic P bodies.

From the few examples cited, it is clear that a number of mechanisms are used to regulate mRNA stability and hence function—just as several mechanisms are used to regulate the synthesis of mRNA. Coordinate regulation of these two processes confers on the cell remarkable adaptability.

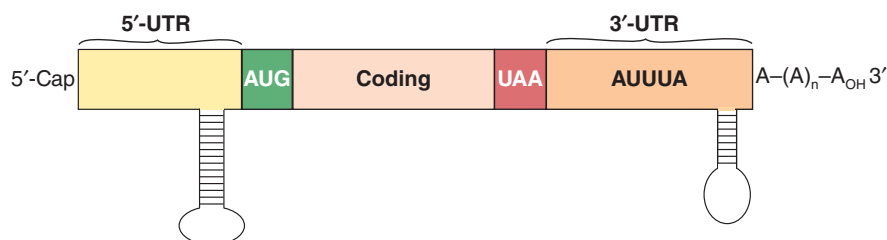

FIGURE 38–21 Structure of a typical eukaryotic mRNA showing elements that are involved in regulating mRNA stability. The typical eukaryotic mRNA has a 5' noncoding sequence (NCS), or untranslated exonic region (5' UTR), a coding region, and a 3' exonic untranslated NCS region (3' UTR). Essentially all mRNAs are capped at the 5' end, and most have a 100 to 200 nt polyadenylate sequence at their 3' end. The 5' cap and 3' poly(A) tail protect the mRNA against exonuclease attack and are bound by specific proteins that interact to facilitate translation (see **Figure 37–7**). Stem-loop structures in the 5' and 3' NCS, and the AU-rich region in the 3' NCS are thought to represent the binding sites for specific proteins that modulate mRNA stability.

SUMMARY

- The genetic constitutions of metazoan somatic cells are nearly all identical.
- Phenotype (tissue or cell specificity) is dictated by differences in gene expression of the cellular complement of genes.
- Alterations in gene expression allow a cell to adapt to environmental changes, developmental cues, and physiological signals.
- Gene expression can be controlled at multiple levels by changes in transcription, RNA processing, localization, and stability or utilization. Gene amplification and rearrangements also influence gene expression.
- Transcription controls operate at the level of protein-DNA and protein-protein interactions. These interactions display protein domain modularity and high specificity.
- Several different classes of DNA-binding domains have been identified in transcription factors.
- Chromatin and DNA modifications contribute importantly in eukaryotic transcription control by modulating DNA accessibility and specifying recruitment of specific coactivators and corepressors to target genes.
- Several epigenetic mechanisms for gene control have been described and the molecular mechanisms through which these processes operate are being elucidated at the molecular level.
- ncRNAs modulate gene expression. The short miRNA and siRNAs modulate mRNA translation and stability; these mechanisms complement transcription controls to regulate gene expression.

REFERENCES

- Bonasio R, Tu S, Reinberg D: Molecular signals of epigenetic states. *Science* 2010;330:612–616.
- Elkon R, Ugalde AP, Agami R: Alternative cleavage and polyadenylation: extent, regulation and function. *Nat Rev Genet* 2013;14:496–506.
- Geisler S, Collier J: RNA in unexpected places: long non-coding RNA functions in diverse cellular contexts. *Nat Rev Mol Cell Biol* 2013;14:699–712.
- Hsin JP, Manley JL: The RNA polymerase II CTD coordinates transcription and RNA processing. *Genes Dev* 2012;26:2119–2137.
- Ishihama A: Prokaryotic genome regulation: a revolutionary paradigm. *Proc Jpn Acad Ser B Phys Biol Sci.* 2012;88:485–508.
- Jacob F, Monod J: Genetic regulatory mechanisms in protein synthesis. *J Mol Biol* 1961;3:318–356.
- Klug A: The discovery of zinc fingers and their applications in gene regulation and genome manipulation. *Annu Rev Biochem* 2010;79:213–231.
- Kornblihtt AR, Schor IE, Alló M, Dujardin G, Petrillo E, Muñoz MJ: Alternative splicing: a pivotal step between eukaryotic transcription and translation. *Nat Rev Mol Cell Biol* 2013;14:153–165.
- Lemon B, Tjian R: Orchestrated response: a symphony of transcription factors for gene control. *Genes Dev* 2000;14:2551–2569.
- Margueron R, Reinberg D: The polycomb complex PRC2 and its mark in life. *Nature* 2011;469:343–349.
- Nabel CS, Kohli RM: Demystifying DNA demethylation. *Science* 2011;333:1229–1230.
- Ørom UA, Shiekhattar R: Long noncoding RNAs usher in a new era in the biology of enhancers. *Cell* 2013;154:1190–1193.
- Pawlicki JM, Steitz JA: Nuclear networking fashions pre-messenger RNA and primary microRNA transcripts for function. *Trends Cell Biol* 2010;20:52–61.
- Ptashne M: *A Genetic Switch*, 2nd ed. Cell Press and Blackwell Scientific Publications, 1992.
- Pugh BF: A preoccupied position on nucleosomes. *Nat Struct Mol Biol* 2010;17:923.
- Roeder RG: Transcriptional regulation and the role of diverse coactivators in animal cells. *FEBS Lett* 2005;579:909–915.
- Schleif RF: Modulation of DNA binding by gene-specific transcription factors. *Biochemistry* 2013;52:6755–6765.
- Small EM, Olson EN: Pervasive roles of microRNAs in cardiovascular biology. *Nature* 2011;469:336–342.
- Weingarten-Gabbay S, Segal E: The grammar of transcriptional regulation. *Human Genetics* 2014;133:701–711.
- Zhang Z, Pugh BF: High-resolution genome-wide mapping of the primary structure of chromatin. *Cell* 2011;144:175–186.

Molecular Genetics, Recombinant DNA, & Genomic Technology

C H A P T E R

39

P. Anthony Weil, PhD

OBJECTIVES

*After studying this chapter,
you should be able to:*

- Explain the basic procedures and methods involved in recombinant DNA technology and genetic engineering.
- Appreciate the rationale behind the methods used to synthesize, analyze, and sequence DNA and RNA.
- Explain how to identify and quantify individual proteins, both soluble and insoluble (ie, membrane bound or compartmentalized intracellularly) proteins, as well as proteins bound to specific sequences of genomic DNA and RNA.

BIOMEDICAL IMPORTANCE*

The development of recombinant DNA, high-density DNA microarrays, high-throughput screening, low-cost genome-scale analyses, DNA sequencing and other molecular genetic methodologies has revolutionized biology and is having an increasing impact on clinical medicine. Though much has been learned about human genetic disease from pedigree analysis and study of affected proteins, in many cases where the specific genetic defect is unknown, these approaches cannot be used. The new technologies circumvent these limitations by going directly to cellular DNA and RNA molecules for information. Manipulation of a DNA sequence and the construction of chimeric molecules—so-called genetic engineering—provide a means of studying how a specific segment of DNA works. New biochemical and molecular genetic tools allow investigators to query and manipulate genomic sequences as well as to examine the entire complement of cellular RNA, protein and protein PTM status at the molecular level.

Understanding molecular genetics technology is important for several reasons: (1) it offers a rational approach to understanding the molecular basis diseases. For example, familial hypercholesterolemia, sickle-cell disease, the thalassemias, cystic fibrosis, muscular dystrophy as well as more complex multifactorial diseases like vascular and heart disease, Alzheimer disease, cancer, obesity and diabetes. (2) Human proteins can be produced in abundance for therapy (eg, insulin, growth hormone, tissue plasminogen activator). (3) Proteins for vaccines (eg, hepatitis B) and for diagnostic testing (eg, Ebola and AIDS tests) can be obtained. (4) This technology is used both to diagnose existing diseases as well as to predict the risk of developing

a given disease and individual response to pharmacological therapeutics. (5) Special techniques have led to remarkable advances in forensic medicine. (6) Gene therapy for potentially curing diseases caused by a single-gene deficiency such as sickle-cell disease, the thalassemias, adenosine deaminase deficiency, and others may be devised.

RECOMBINANT DNA TECHNOLOGY INVOLVES ISOLATION & MANIPULATION OF DNA TO MAKE CHIMERIC MOLECULES

Isolation and manipulation of DNA, including end-to-end joining of sequences from very different sources to make chimeric molecules (eg, molecules containing both human and bacterial DNA sequences in a sequence-independent fashion), is the essence of recombinant DNA research. This involves several unique techniques and reagents.

Restriction Enzymes Cleave DNA Chains at Specific Locations

Certain endonucleases—enzymes that cut DNA at specific DNA sequences within the molecule (as opposed to exonucleases, which processively digest from the ends of DNA molecules)—are a key tool in recombinant DNA research. These enzymes were called **restriction enzymes** because their presence in a given bacterium restricted (ie, prevented) the growth of certain bacterial viruses called bacteriophages. Restriction enzymes cut DNA of any source into unique, short pieces in a sequence-specific

*See glossary of terms at the end of this chapter.

manner—in contrast to most other enzymatic, chemical, or physical methods, which break DNA randomly. These defensive enzymes (hundreds have been discovered) protect the host bacterial DNA from the DNA genome of foreign organisms (primarily infective phages) by specifically inactivating the invading phage DNA by digestion. The viral RNA-inducible interferon system (see Chapter 38; Figure 38–11) provides the same sort of molecular defense against RNA viruses in mammalian cells. However, restriction endonucleases are present only in cells that also have a companion enzyme that site-specifically methylates the host DNA, rendering it an unsuitable substrate for digestion by that particular restriction enzyme. Thus, **site-specific DNA methylases** and restriction enzymes that target the exact same sites always exist in pairs in a bacterium.

Restriction enzymes are named after the bacterium from which they are isolated. For example, *EcoRI* is from *Escherichia coli*, and *BamHI* is from *Bacillus amyloliquefaciens* (Table 39–1). The first three letters in the restriction enzyme name consist of the first letter of the genus (*E*) and the first two letters of the species (*co*). These may be followed by a strain designation (*R*) and a roman numeral (*I*) to indicate the order of discovery (eg, *EcoRI* and *EcoRII*). Each enzyme recognizes and cleaves a specific double-stranded DNA sequence that is typically 4 to 7 bp long. These DNA cuts result in **blunt ends** (eg, *HpaI*) or overlapping (**sticky or cohesive ends**) (eg, *BamHI*) (Figure 39–1), depending on the mechanism used by the enzyme. Sticky ends are particularly useful in constructing hybrid or chimeric DNA molecules (see below). If the four nucleotides are distributed randomly in a given DNA molecule, one can calculate how frequently a given enzyme will cut a length of DNA. For each position in the DNA molecule, there are four possibilities (A, C, G, and T); therefore, a restriction enzyme that recognizes a 4-bp sequence cuts, on average, once every 256 bp (4^4), whereas another enzyme that recognizes a 6-bp sequence cuts once every 4096 bp (4^6). A given piece of DNA has a characteristic linear array of sites for the various enzymes dictated by the linear sequence of its bases; hence, a **restriction map** can be constructed. When DNA is digested with a particular enzyme, the ends of all the fragments have the same DNA sequence. The fragments produced can be isolated by electrophoresis on agarose or polyacrylamide gels (see the discussion of blot transfer, below); this is an essential step in DNA cloning as well as various DNA analyses, and a major use of these enzymes.

A number of other enzymes that act on DNA and RNA are an important part of recombinant DNA technology. Many of these are referred to in this and subsequent chapters (Table 39–2).

Restriction Enzymes, Endonucleases, Recombinases & DNA Ligase Are Used to Modify and Prepare Chimeric DNA Molecules

Sticky, or complementary cohesive-end ligation of DNA fragments is technically easy, but some special techniques are often required to overcome problems inherent in this approach.

TABLE 39–1 Selected Restriction Endonucleases and Their Sequence Specificities

Endonuclease	Sequence Recognized Cleavage Sites Shown	Bacterial Source
<i>BamHI</i>	↓ GGATCC CCTACC ↑	<i>Bacillus amyloliquefaciens</i> H
<i>BglIII</i>	↓ AGATCT TCTAGA ↑	<i>Bacillus globigii</i>
<i>EcoRI</i>	↓ GAATTC CTTAAC ↑	<i>Escherichia coli</i> RY13
<i>EcoRII</i>	↓ CCTGG GGACC ↑	<i>Escherichia coli</i> R245
<i>HindIII</i>	↓ AAGCTT TTCGAA ↑	<i>Haemophilus influenzae</i> R ₄
<i>HhaI</i>	↓ GCGC CGCG ↑	<i>Haemophilus haemolyticus</i>
<i>HpaI</i>	↓ GTTAAC CAATTC ↑	<i>Haemophilus Parainfluenza</i>
<i>MstII</i>	↓ CCTnAGG GGAnTCC ↑	<i>Microcoleus</i> strain
<i>PstI</i>	↓ CTGCAG GACGTC ↑	<i>Providencia stuartii</i> 164
<i>TaqI</i>	↓ TCGA AGCT ↓	<i>Thermus aquaticus</i> YTI

Abbreviations: A, adenine; C, cytosine; G, guanine, T, thymine. Arrows show the site of cleavage; depending on the site, the ends of the resulting cleaved double-stranded DNA are termed sticky ends (*BamHI*) or blunt ends (*HpaI*). The length of the recognition sequence can be 4 bp (*TaqI*), 5 bp (*EcoRII*), 6 bp (*EcoRI*), or 7 bp (*MstII*) or longer. By convention, these are written in the 5' to 3' direction for the upper strand of each recognition sequence, and the lower strand is shown with the opposite (ie, 3'-5') polarity. Note that most recognition sequences are palindromes (ie, the sequence reads the same in opposite directions on the two strands). A residue designated n means that any nucleotide is permitted.

Sticky ends of a vector may reconnect with themselves, with no net gain of DNA. Sticky ends of fragments also anneal so that heterogeneous tandem inserts form. Also, sticky-end sites may not be available or in a convenient position. To circumvent these problems, an enzyme that generates blunt ends can

A. Sticky or staggered ends**B. Blunt ends**

FIGURE 39-1 Results of restriction endonuclease digestion. Digestion with a restriction endonuclease can result in the formation of DNA fragments with sticky, or cohesive, ends (**A**), or blunt ends (**B**); phosphodiester backbone, black lines; interstrand hydrogen bonds between purine and pyrimidine bases, blue. This is an important consideration in devising cloning strategies.

be used. Blunt ends can be ligated directly; however, ligation is not directional. Two alternatives thus exist: new ends are added using the enzyme terminal transferase or synthetic sticky ends are added. If poly d(G) is added to the 3' ends of the vector and poly d(C) is added to the 3' ends of the foreign DNA using terminal transferase, the two molecules can only anneal to each other, thus circumventing the problems listed above. This procedure is called homopolymer tailing.

Alternatively, synthetic blunt-ended duplex oligonucleotide linkers containing the recognition sequence for a convenient restriction enzyme sequence are ligated to the blunt-ended DNA. Direct blunt-end ligation is accomplished using the bacteriophage T4 enzyme DNA ligase. This technique, though less efficient than sticky-end ligation, has the advantage of joining together any pairs of ends. If blunt ends or homopolymer tailing methods are used there is no easy way to retrieve

TABLE 39-2 Some of the Enzymes Used in Recombinant DNA Research

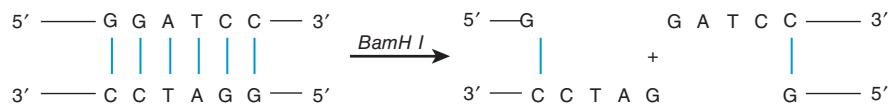
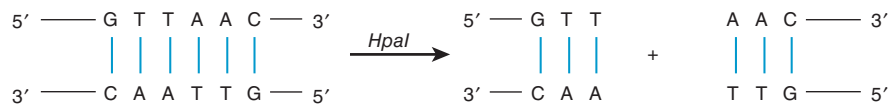
Enzyme	Reaction	Primary Use
Phosphatases	Dephosphorylates 5' ends of RNA and DNA	Removal of 5'-PO ₄ groups prior to kinase labeling; also used to prevent self-ligation
DNA ligase	Catalyzes bonds between DNA molecules	Joining of DNA molecules
DNA polymerase I	Synthesizes double-stranded DNA from single-stranded DNA	Synthesis of double-stranded cDNA; nick translation; generation of blunt ends from sticky ends
Thermostable DNA polymerases	Synthesize DNA at elevated temperatures (60°C-80°C)	Polymerase chain reaction (DNA synthesis)
DNase I	Under appropriate conditions, produces single-stranded nicks in DNA	Nick translation; mapping of hypersensitive sites; mapping protein-DNA interactions
Exonuclease III	Removes nucleotides from 3' ends of DNA	DNA sequencing; ChIP-exo, mapping of DNA-protein interactions
λ Exonuclease	Removes nucleotides from 5' ends of DNA	DNA sequencing
Polynucleotide kinase	Transfers terminal phosphate (γ position) from ATP to 5-OH groups of DNA or RNA	³² P end-labeling of DNA or RNA
Reverse transcriptase	Synthesizes DNA from RNA template	Synthesis of cDNA from mRNA; RNA (5' end) mapping studies
RNAse H	Degrades the RNA portion of a DNA-RNA hybrid	Synthesis of cDNA from mRNA
S1 nuclease	Degrades single-stranded DNA	Removal of "hairpin" in synthesis of cDNA; RNA mapping studies (both 5' and 3' ends)
Terminal transferase	Adds nucleotides to the 3' ends of DNA	Homopolymer tailing
Recombinases (CRE, INT, FLP)	Catalyze site-specific recombination between DNA containing homologous target sequences	Generation of specific chimeric DNA molecules, work both in vitro and in vivo
CRISPER-Cas9	RNA-targeted DNA-directed nuclease	Genome editing and modulation of gene expression

the insert. Alternatively, appropriate cohesive ends can be added through the use of PCR amplification (see below).

As an adjunct to the use of restriction endonucleases scientists have begun utilizing specific prokaryotic or eukaryotic recombinases such as bacterial *lox P* sites, which are recognized by the CRE recombinase, bacteriophage λ att sites recognized by the λ phage encoded INT protein or yeast FRT sites recognized by the yeast F1p recombinase. These recombinase systems all catalyze specific incorporation of two DNA fragments that carry the appropriate recognition sequences and carry out homologous recombination (see Figure 35–9) between the relevant recognition sites. Very recently a novel DNA editing/gene regulatory system termed CRISPR-Cas9 (Clustered Regularly Interspersed Short Palindromic Repeats-CRISPR associated gene 9) has been developed. The CRISPR system, found in many bacteria, represents a form of acquired immunity to infection by bacteriophages, which complements the system of restriction endonucleases and methylases described above. CRISPR uses RNA-based targeting to bring the Cas9 nuclease to foreign (or any complementary) DNA. Within bacteria this CRISPR-RNA-Cas9 complex then degrades and inactivates the targeted DNA. The CRISPR system

has been adapted for use in eukaryotic cells, including human cells. Variations on the use of CRISPR allow for gene deletion, gene editing and even modulation of gene transcription. Thus CRISPR has added an exciting new, highly efficient and very specific technology to the toolbox of methods for the genetic analysis of mammalian cells. The similarities of the CRISPR-Cas RNA-directed targeting and gene inactivation method and mi/siRNA-mediated repression of expression in higher eukaryotes are notable.

Cloning Amplifies DNA

A **clone** is a large population of identical molecules, bacteria, or cells that arise from a common ancestor. Molecular cloning allows for the production of a large number of identical DNA molecules, which can then be characterized or used for other purposes. This technique is based on the fact that chimeric or hybrid DNA molecules can be constructed in **cloning vectors**—typically bacterial plasmids, phages, or cosmids—which then continue to replicate in a host cell under their own control systems. In this way, the chimeric DNA is amplified. The general procedure is illustrated in Figure 39–2.

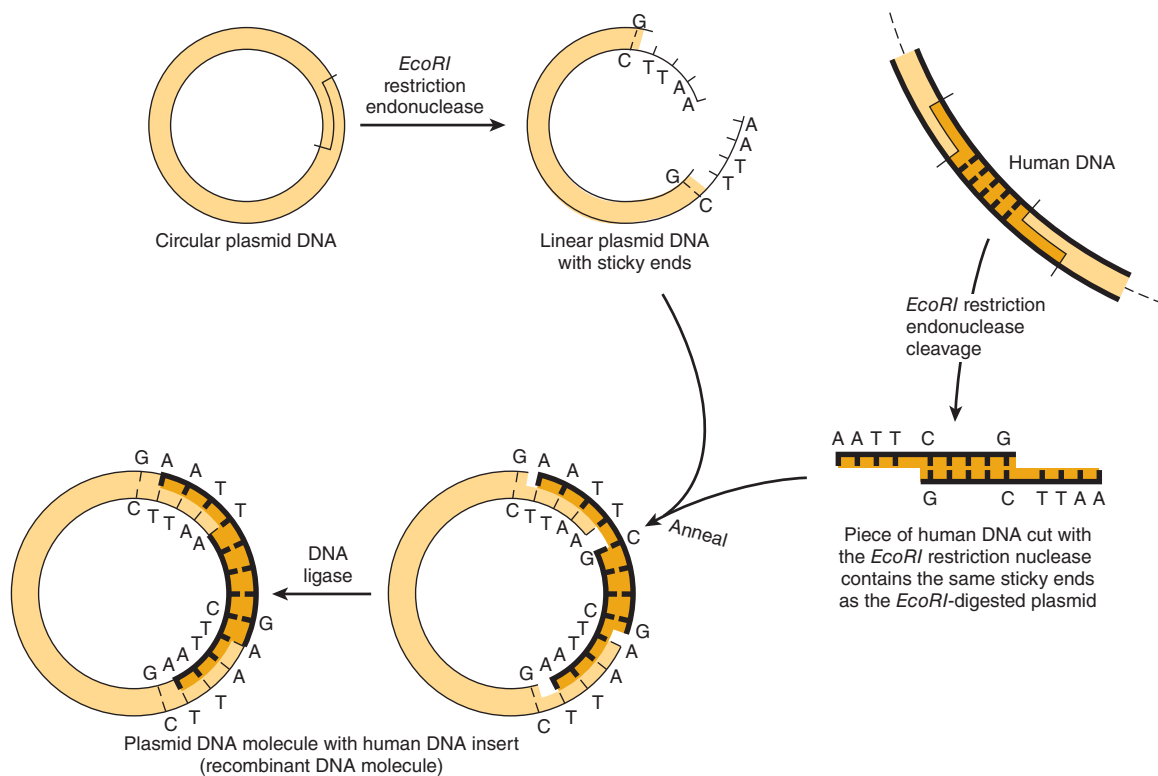

FIGURE 39–2 Use of restriction endonucleases to make new recombinant or chimeric DNA molecules. When inserted back into a bacterial cell (by the process called DNA-mediated transformation), typically only a single plasmid is taken up by a single cell, and the plasmid DNA replicates not only itself but also the physically linked new DNA insert. Since recombining the sticky ends, as indicated, typically regenerates the same DNA sequence recognized by the original restriction enzyme, the cloned DNA insert can be cleanly cut back out of the recombinant plasmid circle with this endonuclease. If a mixture of all of the DNA pieces created by treatment of total human DNA with a single restriction nuclease is used as the source of human DNA, a million or so different types of recombinant DNA molecules can be obtained, each pure in its own bacterial clone. (Modified and reproduced, with permission, from Cohen SN: The manipulation of genes. *Sci Am* [July] 1975;233:25. Copyright © The Estate of Bunji Tagawa.)

Bacterial **plasmids** are small, circular, duplex DNA molecules whose natural function is to confer antibiotic resistance to the host cell. Plasmids have several properties that make them extremely useful as cloning vectors. They exist as single or multiple copies within the bacterium and replicate independently from the bacterial DNA as **episomes** (ie, a genome above or outside the bacterial genome) while using primarily the host replication machinery. The complete DNA sequence of 100s to 1000s of plasmids is known; hence, the precise location of restriction enzyme cleavage sites for inserting the foreign DNA is available. Plasmids are smaller than the host chromosome and are therefore easily biochemically separated from the latter, and the desired plasmid-inserted DNA can be readily removed by cutting the plasmid with the enzyme specific for the restriction site into which the original piece of DNA was inserted.

Phages (bacterial viruses) often have linear DNA molecules into which foreign DNA can be inserted at several restriction enzyme sites. The chimeric DNA is collected after the phage proceeds through its lytic cycle and produces mature, infective phage particles. A major advantage of phage vectors is that while plasmids accept DNA pieces up to about 10 kb long, phages can readily accept DNA fragments 10 to 20 kb long, a limitation imposed by the amount of DNA that can be packed into the phage head during virus propagation.

Larger fragments of DNA can be cloned in **cosmids**, which combine the best features of plasmids and phages. Cosmids are plasmids that contain the DNA sequences, so-called **cos sites**, required for packaging lambda DNA into the phage particle. These vectors grow in the plasmid form in bacteria, but since much of the unnecessary lambda DNA has been removed, more chimeric DNA can be packaged into the particle head. Cosmids can carry inserts of chimeric DNA that are 35 to 50 kb long. Even larger pieces of DNA can be incorporated into bacterial artificial chromosome (**BAC**), yeast artificial chromosome (**YAC**), or *E. coli* bacteriophage P1-based (**PAC**) vectors. These vectors will accept and propagate DNA inserts of several hundred kilobases or more and have largely replaced the plasmid, phage, and cosmid vectors for some cloning and eukaryotic gene mapping/expression applications. A comparison of these vectors is shown in **Table 39–3**.

Because insertion of DNA into a functional region of the vector will interfere with the action of this region, care must

be taken not to interrupt an essential function of the vector. This concept can be exploited, however, to provide a powerful double positive/negative selection technique. For example, a common early plasmid vector **pBR322** has both **Tetracycline (Tet)** and **Ampicillin (Amp)** resistance genes. A single *PstI* restriction enzyme site within the Amp resistance gene is commonly used as the insertion site for a piece of foreign DNA. In addition to having sticky ends (Table 39–1 and Figure 39–1), the DNA inserted at this site disrupts the ampicillin resistance gene (*bla*) that encodes β -lactamase, and makes the bacterium carrying this plasmid Amp-sensitive. Thus, cells carrying the parental plasmid, which provides resistance to both antibiotics, can be readily distinguished and separated from cells carrying the chimeric plasmid, which is resistant only to tetracycline (**Figure 39–3**). YACs contain selection, replication, and segregation functions that work in both bacteria and yeast cells and therefore can be propagated in either organism.

In addition to the vectors described in Table 39–3 that are designed primarily for propagation in bacterial cells, vectors for mammalian cell propagation and insert gene (cDNA)/protein expression have also been developed. These vectors are all based upon various eukaryotic viruses that are composed of RNA or DNA genomes. Notable examples of such **viral vectors** are those utilizing **adenoviral (Ad)**, or **adenovirus-associated viral (AAV)** (DNA-based) and **retroviral** (RNA based) genomes. Though somewhat limited in the size of DNA sequences that can be inserted, such **mammalian viral cloning vectors** make up for this shortcoming because they will efficiently infect a wide range of different cell types. For this reason, various mammalian viral vectors, some with both positive and negative selection genes (*aka* selectable “markers”) as noted above for pBR322, are being investigated for use in **gene therapy** and are commonly used for laboratory experiments.

A Library Is a Collection of Recombinant Clones

The combination of restriction enzymes and various cloning vectors allows the entire genome of an organism to be individually packed into a vector. A collection of these different recombinant clones is called a library. A **genomic library** is prepared from the total DNA of a cell line or tissue. A **cDNA library** comprises complementary DNA copies of the population of mRNAs in a tissue. Genomic DNA libraries are often prepared by performing **partial digestion of total DNA** with a restriction enzyme that cuts DNA frequently (eg, a four base cutter such as *TaqI*). The idea is to generate rather large fragments so that most genes will be left intact. The BAC, YAC, and P1 vectors are preferred since they can accept very large fragments of DNA and thus offer a better chance of isolating an intact eukaryotic mRNA-encoding gene on a single DNA fragment.

A vector in which the protein coded by the gene introduced by recombinant DNA technology is actually synthesized is known as an **expression vector**. Such vectors are now commonly used to detect specific cDNA molecules in libraries

TABLE 39–3 Cloning Capacities of Common Cloning Vectors

Vector	DNA Insert Size (kb)
Plasmid pUC19	0.01-10
Lambda charon 4A	10-20
Cosmids	35-50
BAC, P1	50-250
YAC	500-3000

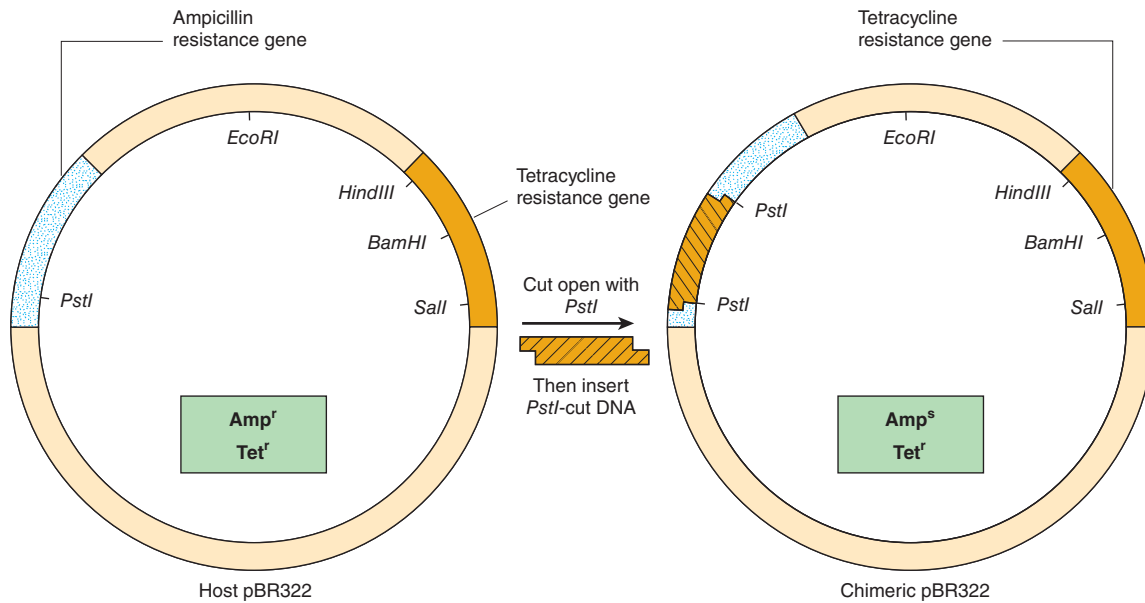

FIGURE 39-3 A method of screening recombinants for inserted DNA fragments. Using the plasmid pBR322, a piece of DNA is inserted into the unique *PstI* site. This insertion disrupts the gene coding for a protein that provides ampicillin resistance to the host bacterium. Hence, cells carrying the chimeric plasmid will no longer grow/survive when grown in liquid or plated on a substrate medium that contains this antibiotic. The differential sensitivity to tetracycline and ampicillin can therefore be used to distinguish clones of plasmid that contain an insert. A similar scheme relying upon production of an in-frame fusion of a newly inserted DNA producing a peptide fragment capable of complementing an inactive, N-terminally truncated form of the enzyme β -galactosidase, a component of the *lac* operon (Figure 38-2) allows for blue-white colony formation on agar plates containing a dye hydrolyzable by β -galactosidase. β -galactosidase-positive colonies are blue; such colonies contain plasmids in which a DNA was successfully inserted.

and to produce proteins by genetic engineering techniques. These vectors are specially constructed to contain very active inducible promoters, proper in-phase translation initiation codons, both transcription and translation termination signals, and appropriate protein processing signals, if needed. Some expression vectors even contain genes that code for protease inhibitors, so that the final yield of product is enhanced. Interestingly, as the cost of synthetic DNA synthesis has dropped, many investigators often synthesize an entire cDNA (gene) of interest (in 100-150 nt segments) incorporating the codon preferences of the host used for expression in order to maximize protein production. New efficiencies in synthetic DNA synthesis now allow for the *de novo* synthesis of complete genes and even genomes. These advances usher in new and exciting possibilities in synthetic biology while concomitantly introducing potential ethical conundrums.

Probes Search Libraries or Complex Samples for Specific Genes or cDNA Molecules

A variety of molecules can be used to “probe” libraries in search of a specific gene or cDNA molecule or to define and quantitate DNA or RNA separated by electrophoresis through various gels. Probes are generally pieces of DNA or RNA labeled with a ^{32}P -containing nucleotide—or fluorescently

labeled nucleotides (more commonly now). Importantly, neither modification (^{32}P or fluorescent-label) affects the hybridization properties of the resulting labeled nucleic acid probes. The probe must recognize a complementary sequence to be effective. A cDNA synthesized from a specific mRNA (or synthetic oligonucleotide) can be used to screen either a cDNA library for a longer cDNA or a genomic library for a complementary sequence in the coding region of a gene. cDNA/oligonucleotide/cRNA probes are used to detect DNA fragments on Southern blot transfers and to detect and quantitate RNA on Northern blot transfers (see below).

Blotting & Hybridization Techniques Allow Visualization of Specific Fragments

Visualization of a specific DNA or RNA fragment among the many thousands of “contaminating” nontarget molecules in a complex sample requires the convergence of a number of techniques, collectively termed **blot transfer**. Figure 39-4 illustrates the **Southern** (DNA), **Northern** (RNA), and **Western** (protein) blot transfer procedures. (The first is named for the person who devised the technique [Edward Southern], and the other names began as laboratory jargon but are now accepted terms.) These procedures are useful in determining how many copies of a gene are in a given tissue or whether there are any alterations in a gene (deletions, insertions, or rearrangements)

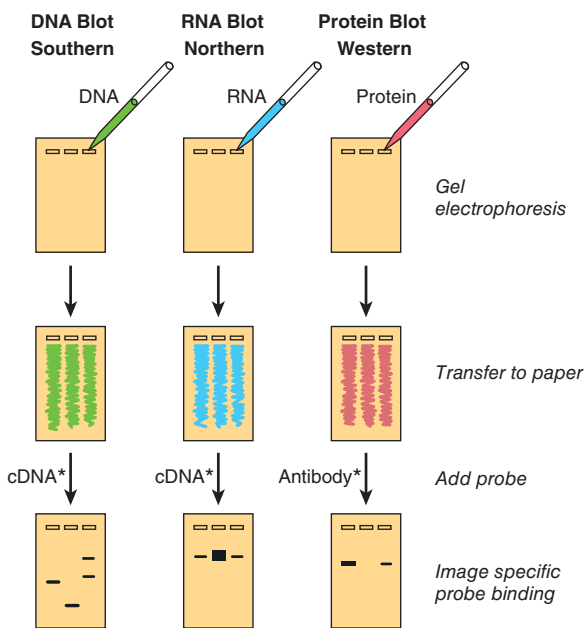

FIGURE 39–4 The blot transfer procedure. In a Southern, or DNA blot transfer, DNA isolated from a cell line or tissue is digested with one or more restriction enzymes. This mixture is pipetted into a well in an agarose or polyacrylamide gel and exposed to a direct electrical current. DNA, being negatively charged, migrates toward the anode; the smaller fragments move the most rapidly. After a suitable time, the DNA within the gel is denatured by exposure to mild alkali and transferred to nitrocellulose or nylon paper, resulting in an exact replica of the pattern on the gel, using the blotting technique devised by Southern. The DNA is bound to the paper by exposure to heat or UV, and the paper is then exposed to the labeled cDNA probe, which hybridizes to complementary strands on the filter. After thorough washing, the paper is exposed to x-ray film or an imaging screen, which is developed to reveal several specific bands corresponding to the DNA fragment(s) that were recognized (hybridized to) the sequences in the cDNA probe. The RNA, or Northern, blot is conceptually similar. RNA is subjected to electrophoresis before blot transfer. This requires some different steps from those of DNA transfer, primarily to ensure that the RNA remains intact, and is generally somewhat more difficult. In the protein, or Western, blot, proteins are electrophoresed and transferred to special paper that avidly binds proteins and then probed with a specific antibody or other probe molecule. (Asterisks signify labeled probes, either radioactive or fluorescent.) In the case of Southwestern blotting (see the text; not shown), a protein blot similar to that shown above under “Western” is exposed to labeled nucleic acid, and protein-nucleic acid complexes formed are detected by autoradiography or imaging.

because the requisite electrophoresis step separates the molecules on the basis of size. Occasionally, if a specific base is changed and a restriction site is altered, these procedures can detect a point mutation (ie, Figure 39–9 below). The Northern and Western blot transfer techniques are used to size and quantitate specific RNA and protein molecules, respectively. A fourth hybridization technique, the **Southwestern** blot, examines protein-DNA interactions (not shown). In this method, proteins are separated by electrophoresis, blotted to a membrane, renatured, and analyzed for an interaction with a particular sequence by incubation with a specific labeled nucleic acid probe.

All of the hybridization procedures discussed in this section depend on the specific base-pairing properties of complementary nucleic acid strands described above. Perfect matches hybridize readily and withstand high temperatures and/or low ionic strength buffer in the hybridization and washing reactions. Less than perfect matches do not tolerate such **stringent conditions** (ie, elevated temperatures and low salt concentrations); thus, hybridization either never occurs or is disrupted during the washing step. Hybridization conditions capable of detecting just a single base-pair (bp) mismatch between probe and target have been devised.

Manual & Automated Techniques Are Available to Determine the Sequence of DNA

The segments of specific DNA molecules obtained by recombinant DNA technology can be analyzed to determine their nucleotide sequence. DNA sequencing depends upon having a large number of identical DNA molecules. This requirement can be satisfied by cloning the fragment of interest, either using the techniques described above, or by using PCR methods (see below). The **manual enzymatic Sanger method** employs specific dideoxynucleotides that terminate DNA strand synthesis at specific nucleotides as the strand is synthesized on purified template nucleic acid. The reactions are adjusted so that a population of DNA fragments representing termination at every nucleotide is obtained. By having a radioactive label incorporated at the termination site, one can separate the fragments according to size using polyacrylamide gel electrophoresis. An autoradiograph is made, and each of the fragments produces an image (band) on an x-ray film or imaging plate. These are read in order to give the DNA sequence (Figure 39–5). Techniques that do not require the use of radioisotopes are employed in automated DNA sequencing. Most commonly employed is an automated procedure in which four different fluorescent labels—one representing each nucleotide—are used. Each emits a specific signal upon excitation by a laser beam of a particular wavelength that is measured by sensitive detectors, and these signals can be recorded by a computer. The newest DNA sequencing machines use fluorescently labeled nucleotides but detect incorporation using microscopic optics. These machines have reduced the cost of DNA sequencing dramatically, over 100 times. These reductions in cost have ushered in the era of personalized genome sequencing. Indeed, using this new technology the genome sequence of the codiscoverer of the double helix, James Watson, was completely determined.

Oligonucleotide Synthesis Is Now Routine

The automated chemical synthesis of moderately long oligonucleotides (~100 nucleotides) of precise sequence is now a routine laboratory procedure. Each synthetic cycle takes but a few minutes such that an entire molecule can be made by synthesizing relatively short segments that can then be ligated to one another. As mentioned above, the process has been

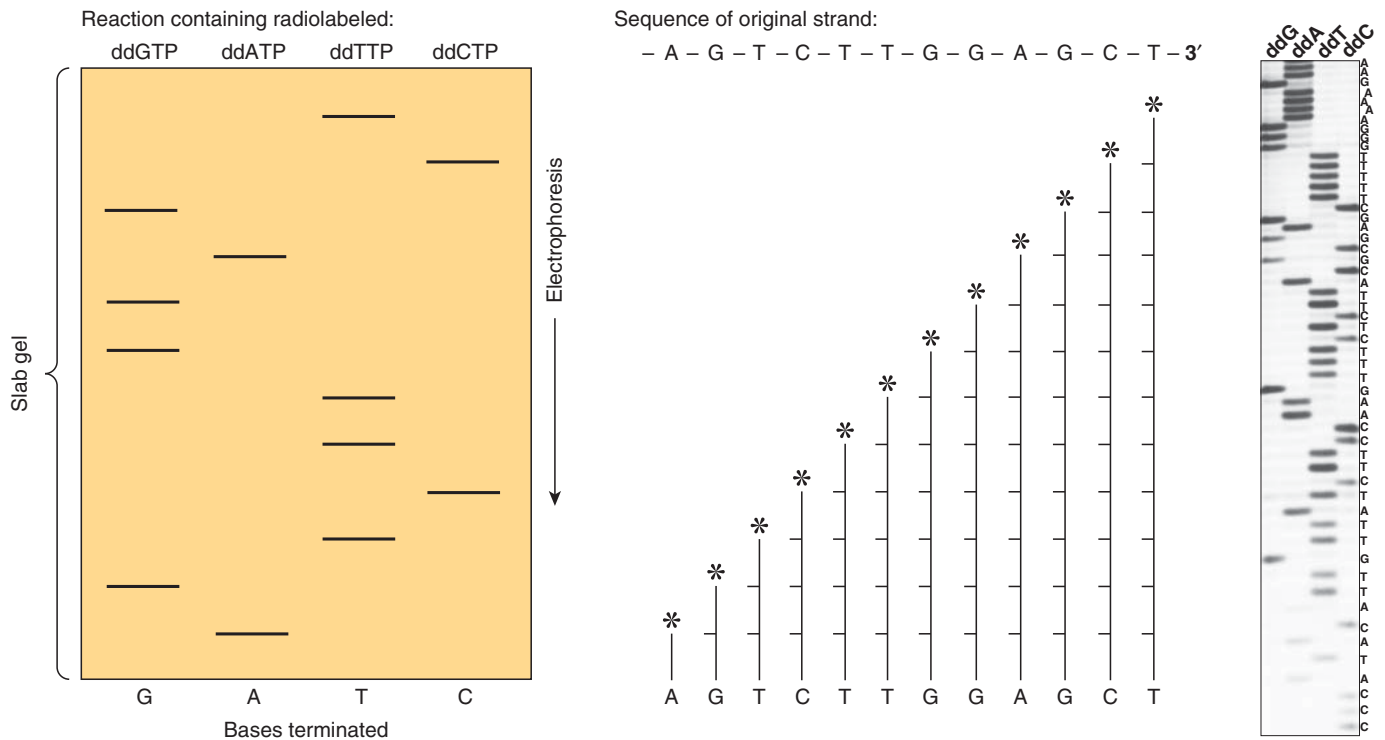

FIGURE 39-5 Sequencing of DNA by the chain termination method devised by Sanger. The ladder-like arrays represent from bottom to top all of the successively longer fragments of the original DNA strand. Knowing which specific dideoxynucleotide reaction was conducted to produce each mixture of fragments, one can determine the sequence of nucleotides from the unlabeled end toward the labeled end (*) by reading up the gel. The base-pairing rules of Watson and Crick (A–T, G–C) dictate the sequence of the other (complementary) strand. (Asterisks signify site of radiolabeling.) Schematically shown (**left, middle**) are the terminated synthesis products of a hypothetical fragment of DNA, sequence listed (**middle, top**). An autoradiogram (**right**) of an actual set of DNA sequencing reactions that utilized the four ^{32}P -labeled dideoxynucleotides indicated at the top of the scanned autoradiogram (ie, dideoxy(dd)G, ddA, ddT, ddC). Electrophoresis was from top to bottom. The deduced DNA sequence is listed on the right side of the gel. Note the log-linear relationship between distance of migration (ie, top to bottom of gel) and DNA fragment length. Current state-of-the-art DNA sequencers no longer utilize gel electrophoresis for fractionation of labeled synthesis products. Moreover in the NGS sequencing platforms, synthesis is followed by monitoring incorporation of the four fluorescently labeled dXTPs.

miniaturized and can be significantly parallelized to allow the synthesis of 100s to 1000s of defined sequence oligonucleotides simultaneously. Oligonucleotides are now indispensable for DNA sequencing, library screening, protein–DNA binding assays, the polymerase chain reaction (PCR) (see below), site-directed mutagenesis, complete synthetic gene synthesis as well as complete (bacterial) genome synthesis and numerous other applications.

The Polymerase Chain Reaction (PCR) Method Amplifies DNA Sequences

The **PCR** is a method of amplifying a target sequence of DNA. The development of PCR has revolutionized the ways in which both DNA and RNA can be studied. PCR provides a sensitive, selective, and extremely rapid means of amplifying any desired sequence of DNA. Specificity is based on the use of two oligonucleotide primers that hybridize to complementary sequences on opposite strands of DNA and flank the target sequence (**Figure 39-6**). The DNA sample is first heat denatured (>90°C) to separate the two strands of the template

DNA containing the target sequence; the primers, added in vast excess, are allowed to anneal to the DNA (typically 50°C–75°C); and each strand is copied by a DNA polymerase, starting at the primer sites in the presence of all four dXTPs (again in vast excess). The two DNA strands each serve as a template for the synthesis of new DNA from the two primers. Repeated cycles of heat denaturation, annealing of the primers to their complementary sequences, and extension of the annealed primers with DNA polymerase result in the exponential amplification of DNA segments of defined length (a doubling at each cycle). DNA synthesis is catalyzed by a heat-stable DNA polymerase purified from one of a number of different thermophilic bacteria, organisms that grow at 70°C to 80°C. Thermostable DNA polymerases withstand short incubations at over 90°, temperatures required to completely denature DNA. These thermostable DNA polymerases have made automation of PCR possible.

DNA sequences as short as 50 to 100 bp and as long as 10 kb can be amplified by PCR. Twenty cycles provide an amplification of 10^6 (ie, 2^{20}) and 30 cycles, 10^9 (2^{30}). Each cycle takes ≤5 to 10 minutes so that even large DNA molecules can be

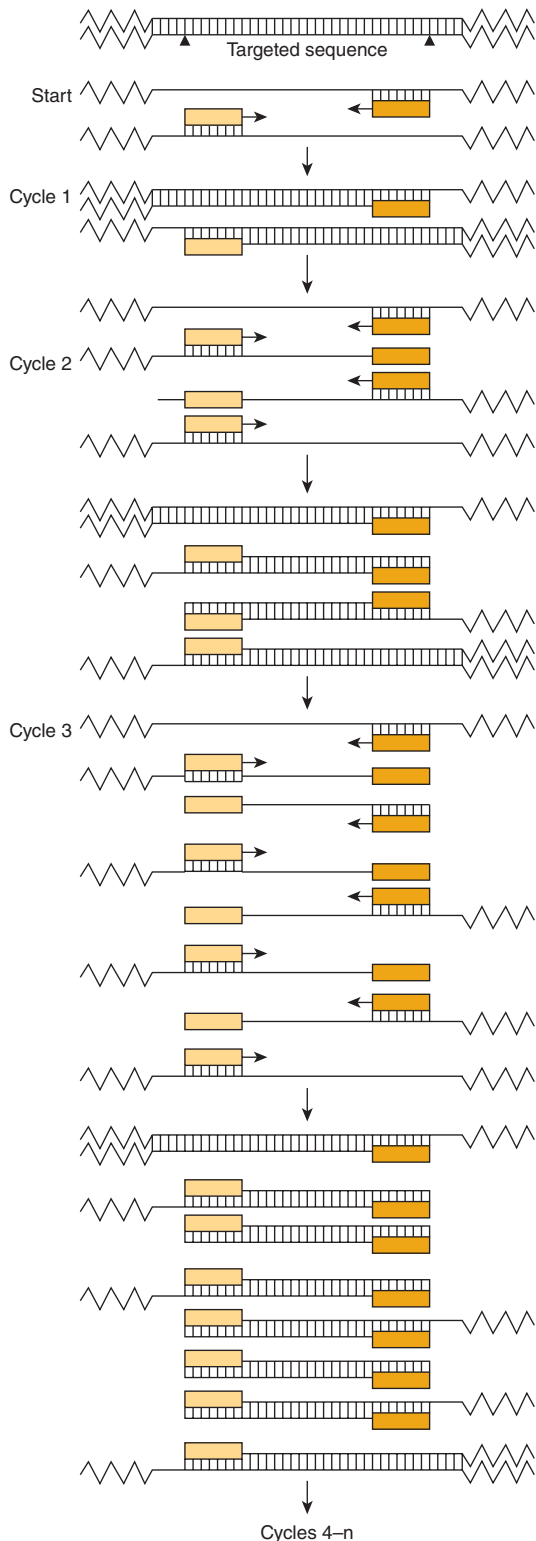

FIGURE 39–6 The polymerase chain reaction is used to amplify specific gene sequences. Double-stranded DNA is heated to separate it into individual strands. These bind two distinct primers that are directed at specific sequences on opposite strands and that define the segment to be amplified. DNA polymerase extends the primers in each direction and synthesizes two strands complementary to the original two. This cycle is repeated several times, giving an amplified product of defined length and sequence. Note that the 4 dXTPs and the two primers are present in vast excess so as not to be limiting for polymerization/amplification.

amplified rapidly. The PCR allows the DNA in a single cell, hair follicle, or spermatozoon to be amplified and analyzed. Thus, the applications of PCR to forensic medicine are obvious. The PCR is also used (1) to detect infectious agents, especially latent viruses; (2) to make prenatal genetic diagnoses; (3) to detect allelic polymorphisms; (4) to establish precise tissue types for transplants; and (5) to study evolution, using DNA from archeological samples (6) for quantitative RNA analyses after RNA copying and mRNA quantitation by the so-called RT-PCR method (cDNA copies of mRNA generated by a retroviral reverse transcriptase) or (7) to score *in vivo* protein-DNA occupancy using chromatin immunoprecipitation assays (see below). New uses of PCR are developed every year.

PRACTICAL APPLICATIONS OF RECOMBINANT DNA TECHNOLOGY ARE NUMEROUS

The isolation of a specific (ca 1000 bp) mRNA-encoding gene from an entire genome requires a technique that will discriminate one part in a million. The identification of a regulatory region that may be only 10 bp in length requires a sensitivity of one part in 3×10^8 ; a disease such as sickle-cell anemia is caused by a single base change, or one part in 3×10^9 . DNA technology is powerful enough to accomplish all these things.

Gene Mapping Localizes Specific Genes to Distinct Chromosomes

Gene localization thus can define a map of the human genome. This is already yielding useful information in the definition of human disease. Somatic cell hybridization and *in situ* hybridization are two techniques used to accomplish this. In ***in situ* hybridization**, the simpler and more direct procedure, a radioactive probe is added to a metaphase spread of chromosomes on a glass slide. The exact area of hybridization is localized by layering photographic emulsion over the slide and, after exposure, lining up the grains with some histologic identification of the chromosome. **Fluorescence *in situ* hybridization (FISH)**, which utilizes fluorescent rather than radioactively labeled probes, is a very sensitive technique that is also used for this purpose. This often places the gene at a location on a given band or region on the chromosome. Some of the human genes localized using these techniques are listed in **Table 39–4**. This table represents only a sampling of mapped genes since tens of thousands of genes have been mapped as a result of the recent sequencing of human genomes. Once the defect is localized to a region of DNA that has the characteristic structure of a gene, a synthetic cDNA copy of the gene can be constructed, which contains only mRNA encoding exons, and expressed in an appropriate vector and its function can be assessed—or the putative polypeptide, deduced from the open reading frame in the coding region, can be synthesized. Antibodies directed against this protein or peptide fragments derived therefrom can be used to assess whether this protein is expressed in

TABLE 39–4 Localization of Human Genes^a

Gene	Chromosome	Disease
Insulin	11p15	Diabetes
Prolactin	6p23-q12	Sheehan syndrome
Growth hormone	17q21-qter	Growth hormone deficiency
α -Globin	16p12-pter	α -Thalassemia
β -Globin	11p12	β -Thalassemia, sickle cell
Adenosine deaminase	20q13-qter	Adenosine deaminase deficiency
Phenylalanine hydroxylase	12q24	Phenylketonuria
Hypoxanthine-guanine phosphoribosyltransferase	Xq26-q27	Lesch-Nyhan syndrome
DNA segment G8	4p	Huntington chorea

^aThis table indicates the chromosomal location of several genes and the diseases associated with deficient or abnormal production of the gene products. The chromosome involved is indicated by the first number or letter. The other numbers and letters refer to precise localizations, as defined in McKusick VA: *Mendelian Inheritance in Man: Catalogs of Autosomal Dominant, Autosomal Recessive, and X-Linked Phenotypes*. Copyright © 1983 Johns Hopkins University Press. Reprinted with permission from the Johns Hopkins University Press.

normal persons and whether it is absent, or altered in those with the genetic syndrome.

Proteins Can Be Produced for Research, Diagnosis, & Commerce

A practical goal of recombinant DNA research is the production of materials for biomedical applications. This technology has two distinct merits: (1) it can supply large amounts of material that could not be obtained by conventional purification methods (eg, interferon, tissue plasminogen activating factor, etc); and (2) It can provide human proteins (eg, insulin and growth hormone). The advantages in both cases are obvious. Although the primary aim is to supply products—generally proteins—for treatment (insulin) and diagnosis (AIDS testing) of human and other animal diseases and for disease prevention (hepatitis B vaccine), there are other potential commercial applications, especially in agriculture. An example of the latter is the attempt to engineer plants that are more resistant to drought or temperature extremes, more efficient at fixing nitrogen, or that produce seeds containing the complete complement of essential amino acids (rice, wheat, corn, etc).

Recombinant DNA Technology Is Used in the Molecular Analysis of Disease

Normal Gene Variations

There is a normal variation of DNA sequence just as is true of more obvious aspects of human structure. Variations of DNA

sequence, **polymorphisms**, occur approximately once in every 500 to 1000 nucleotides. A recent comparison of the nucleotide sequence of the genome of James Watson, the codiscoverer of DNA structure, identified about 3,300,000 single-nucleotide polymorphisms (SNPs) relative to the “standard” initially sequenced human reference genome. Interestingly, >80% of the SNPs found in Watson’s DNA had already been identified in other individuals. There are also genomic deletions and insertions of DNA (ie, **copy number variations; CNV**) as well as single-base substitutions. In healthy people, these alterations obviously occur in noncoding regions of DNA or at sites that cause no change in function of the encoded protein. This heritable polymorphism of DNA structure can be associated with certain diseases within a large kindred and can be used to search for the specific gene involved, as is illustrated below. It can also be used in a variety of applications in forensic medicine.

Gene Variations Causing Disease

Classic genetics taught that most genetic diseases were due to point mutations that resulted in an impaired protein. This may still be true, but if on reading previous chapters one predicted that genetic disease could result from derangement of any of the steps leading from replication to transcription to RNA processing/transport and protein synthesis, PTMs and/or subcellular localization and physical state (ie, aggregation and polymerization) one would have made a proper assessment. This point is again nicely illustrated by examination of the β -globin gene. This gene is located in a cluster on chromosome 11 (**Figure 39–7**), and an expanded version of the gene is illustrated in **Figure 39–8**. Defective production of β -globin results in a variety of diseases and is due to many different lesions in and around the β -globin gene (**Table 39–5**).

Point Mutations

The classic example is **sickle-cell disease**, which is caused by mutation of a single base out of the 3×10^9 in the genome, a T-to-A DNA substitution, which in turn results in an A-to-U change in the mRNA corresponding to the sixth codon of the β -globin gene. The altered codon specifies a different amino acid (valine rather than glutamic acid), and this causes a structural abnormality of the β -globin molecule leading to hemoglobin aggregation and red blood cell “sickling.” Other point mutations in and around the β -globin gene result in decreased or, in some instances, no production of β -globin; β -thalassemia is the result of these mutations. (The thalassemias are characterized by defects in the synthesis of hemoglobin subunits, and so β -thalassemia results when there is insufficient production of β -globin.) **Figure 39–8** illustrates that point mutations affecting each of the many processes involved in generating a normal mRNA (and therefore a normal protein) have been implicated as a cause of β -thalassemia.

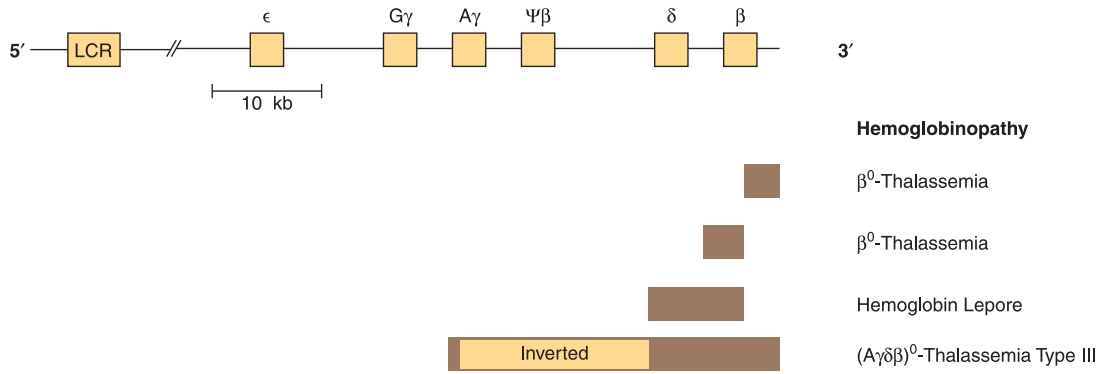

FIGURE 39-7 Schematic representation of the β -globin gene cluster and of the lesions in some genetic disorders. The β -globin gene is located on chromosome 11 in close association with the two γ -globin genes and the δ -globin gene. The β -gene family is arranged in the order 5'- ϵ -G γ -A γ - $\Psi\beta$ - δ - β -3'. The ϵ locus is expressed in early embryonic life (as $\alpha_2\epsilon_2$). The γ genes are expressed in fetal life, making fetal hemoglobin (HbF, $\alpha_2\gamma_2$). Adult hemoglobin consists of HbA ($\alpha_2\beta_2$) or HbA 2 ($\alpha_2\delta_2$). The $\Psi\beta$ is a pseudogene that has sequence homology with β but contains mutations that prevent its expression. A locus control region (LCR), a powerful enhancer located upstream (5') from the gene, controls the rate of transcription of the entire β -globin gene cluster. Deletions (solid darker bars, lower) within the β locus cause β -thalassemia (deficiency or absence [β^0] of β -globin). Meiotic recombination between δ and β causes hemoglobin Lepore, and results in DNA deletion and δ - β coding sequence fusions reducing the levels of HbB (see Figures 6-7 and 35-10). An inversion ($A\gamma\delta\beta$)⁰ in this region (largest bar) disrupts gene function and also results in thalassemia (type III). Each type of thalassemia tends to be found in a certain group of people, eg, the ($A\gamma\delta\beta$)⁰ deletion inversion occurs in persons from India. Many more deletions in this region have been mapped, and each causes some type of thalassemia.

Deletions, Insertions, & Rearrangements of DNA

Studies of bacteria, viruses, yeasts, fruit flies, and now humans show that pieces of DNA can move from one place to another within a genome. The deletion of a critical piece of DNA, the rearrangement of DNA within a gene, or the insertion or amplification of a piece of DNA within a coding or regulatory region can all cause changes in gene expression resulting in disease. Again, a molecular analysis of thalassemias produces numerous examples of these processes—particularly deletions—as causes of disease (Figure 39-7). The globin gene clusters seem particularly prone to this lesion. Deletions in the α -globin cluster, located on chromosome 16, cause α -thalassemia. There is a strong ethnic association for many of these deletions, so that northern Europeans, Filipinos, blacks, and Mediterranean peoples have different lesions all resulting in the absence of hemoglobin A and α -thalassemia.

TABLE 39-5 Structural Alterations of the β -Globin Gene

Alteration	Function Affected	Disease
Point mutations	Protein folding	Sickle cell disease
	Transcriptional control	β -Thalassemia
	Frameshift and nonsense mutations	β -Thalassemia
	RNA processing	β -Thalassemia
Deletion	mRNA production	β^0 -Thalassemia
		Hemoglobin Lepore
Rearrangement	mRNA production	β -Thalassemia type III

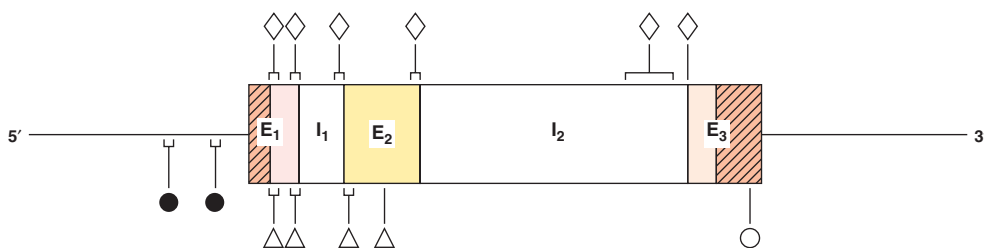

FIGURE 39-8 Mutations in the β -globin gene causing β -thalassemia. The β -globin gene is shown in the 5' to 3' orientation. The cross-hatched areas indicate the 5' and 3' nontranslated regions. Reading from the 5' to 3' direction, the shaded areas are exons 1 to 3 (E_1 , E_2 , E_3) and the clear spaces are introns 1 (I_1) and 2 (I_2). Mutations that affect transcription control (●) are located in the 5' flanking-region DNA. Examples of nonsense mutations (Δ), mutations in RNA processing (\diamond), and RNA cleavage mutations (\circ) have been identified and are indicated. In some regions, many distinct mutations have been found. These are indicated by the size and location of the brackets.

A similar analysis could be made for a number of other diseases. Point mutations are usually defined by sequencing the gene in question, though occasionally, if the mutation destroys or creates a restriction enzyme site, the technique of restriction fragment analysis can be used to pinpoint the lesion. Deletions or insertions of DNA larger than 50 bp can often be detected by the Southern blotting procedure while PCR-based assays can detect much smaller changes in DNA structure.

Pedigree Analysis

Sickle-cell disease again provides an excellent example of how recombinant DNA technology can be applied to the study of human disease. The substitution of T for A in the template strand of DNA in the β -globin gene changes the sequence in the region that corresponds to the sixth codon from



to



and destroys a recognition site for the restriction enzyme *MstII* (CCTNAGG; denoted by the small vertical arrows; Table 39-1).

Other *MstII* sites 5' and 3' from this site (**Figure 39-9**) are not affected and so will be cut. Therefore, incubation of DNA from normal (AA), heterozygous (AS), and homozygous (SS) individuals results in three different patterns on Southern blot transfer (Figure 39-9). This illustrates how a DNA pedigree can be established using the principles discussed in this chapter. Pedigree analysis has been applied to a number of genetic diseases and is most useful in those caused by deletions and insertions or the rarer instances in which a restriction endonuclease cleavage site is affected, as in the example cited here.

A. *MstII* restriction sites around and in the β -globin gene

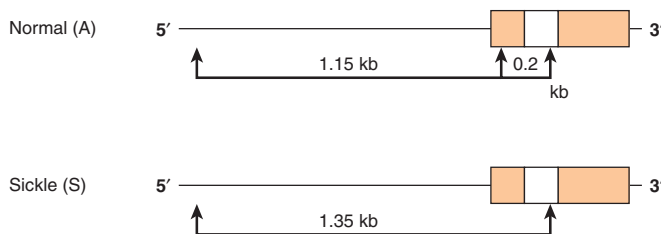

B. Pedigree analysis

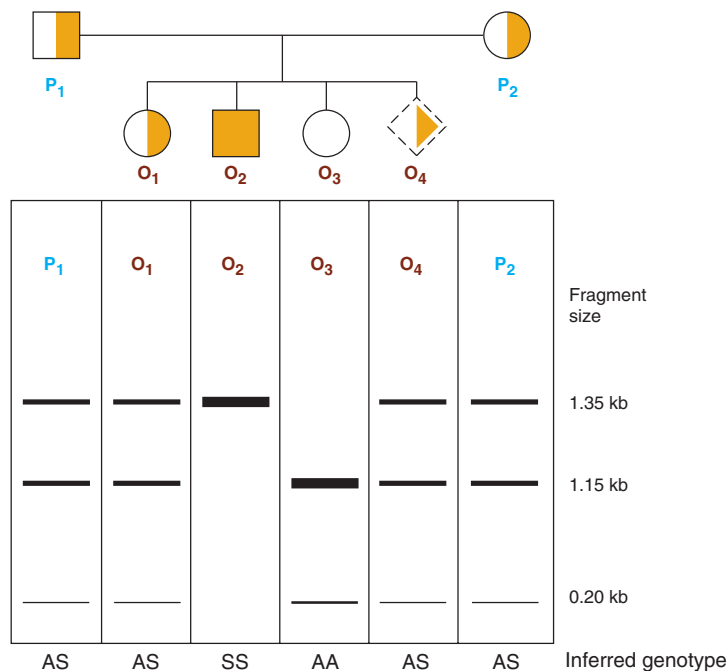

FIGURE 39-9 Pedigree analysis of sickle-cell disease. The top part of the figure (A) shows the first part of the β -globin gene and the *MstII* restriction enzyme sites in the normal (A) and sickle-cell (S) β -globin genes. Digestion with the restriction enzyme *MstII* results in DNA fragments 1.15 kb and 0.2 kb long in normal individuals. The T-to-A change in individuals with sickle-cell disease abolishes one of the three *MstII* sites around the β -globin gene; hence, a single restriction fragment 1.35 kb in length is generated in response to *MstII*. This size difference is easily detected on a Southern blot. (B) Pedigree analysis shows three possibilities: AA = normal (open circle); AS = heterozygous (half-solid circles, half-solid square); SS = homozygous (solid square). This approach can allow for prenatal diagnosis of sickle-cell disease (dash-sided square). See the text.

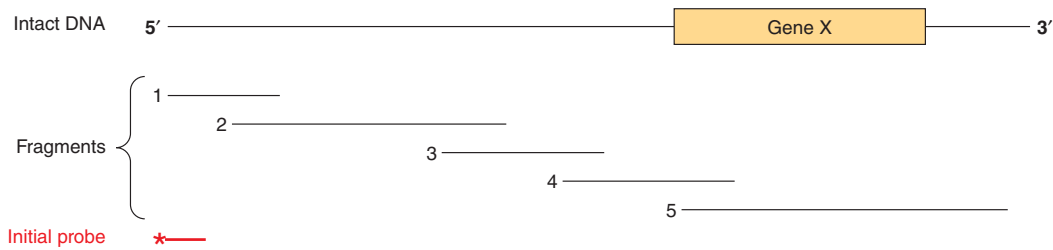

FIGURE 39–10 The technique of chromosome walking. Gene X is to be isolated from a large piece of DNA. The exact location of this gene is not known, but a probe (*—) directed against a fragment of DNA (shown at the 5′ end in this representation) is available, as is a library of clones containing a series of overlapping DNA insert fragments. For the sake of simplicity, only five of these are shown. The initial probe will hybridize only with clones containing fragment 1, which can then be isolated and used as a probe to detect fragment 2. This procedure is repeated until fragment 4 hybridizes with fragment 5, which contains the entire sequence of gene X. A conceptually similar method of DNA sequence overlap is used to assemble the contiguous sequence reads generated by direct NGS/high throughput sequencing of genomic DNA fragments.

Such analyses are now facilitated by the PCR reaction, which can amplify and hence provide sufficient DNA for analysis from just a few nucleated cells.

Prenatal Diagnosis

If the genetic lesion is understood and a specific probe is available, prenatal diagnosis is possible. DNA from cells collected from as little as 10 mL of amniotic fluid (or by chorionic villus biopsy) can be analyzed by Southern blot transfer, and even smaller volumes if PCR-based assays are used. A fetus with the restriction pattern AA in Figure 39–9 neither have sickle-cell disease, nor is it a carrier. A fetus with the SS pattern will develop the disease. Probes are now available for this type of analysis of many genetic diseases.

Restriction Fragment Length Polymorphism and SNPs

The differences in DNA sequence cited above can result in variations of restriction sites and thus in the length of restriction fragments. Similarly, single nucleotide polymorphisms, or **SNPs**, can be detected by the sensitive PCR method. An inherited difference in the pattern of restriction enzyme digestion (eg, a DNA variation occurring in more than 1% of the general population) is known as a **restriction fragment length polymorphism (RFLP)**. Extensive RFLP and SNP maps of the human genome have been constructed. This is proving useful in the Human Genome Analysis Project and is an important component of the effort to understand various single-gene and multigenic diseases. RFLPs result from single-base changes (eg, sickle-cell disease) or from deletions or insertions (CNVs) of DNA into a restriction fragment (eg, the thalassemias) and have proved to be useful diagnostic tools. They have been found at known gene loci and in sequences that have no known function; thus, RFLPs may disrupt the function of the gene or may have no apparent biologic consequences. As mentioned above, 80% of the SNPs in the genome

of a single known individual had already been mapped independently through the efforts of the SNP-mapping component of the International HapMap Project and now supplemented by genomic sequencing.

RFLPs and SNPs are inherited, and they segregate in a mendelian fashion. A major use of SNPs/RFLPs is in the definition of inherited diseases in which the functional deficit is unknown. SNPs/RFLPs can be used to establish linkage groups, which in turn, by the process of **chromosome walking**, will eventually define the disease locus. In chromosome walking (**Figure 39–10**), a fragment representing one end of a long piece of DNA is used to isolate another that overlaps but extends the first. The direction of extension is determined by restriction mapping, and the procedure is repeated sequentially until the desired sequence is obtained. Collections of mapped, overlapping BAC- or PAC-cloned human genomic DNAs are commercially available. The X chromosome-linked disorders are particularly amenable to the approach of chromosome walking since only a single allele is expressed. Hence, 20% of the defined RFLPs are on the X chromosome and a complete linkage map (and genomic sequence) of this chromosome have been determined. The gene for the X-linked disorder, Duchenne-type muscular dystrophy, was found using RFLPs. Similarly, the defect in Huntington disease was localized to the terminal region of the short arm of chromosome 4, and the defect that causes polycystic kidney disease is linked to the α -globin locus on chromosome 16. Genomic sequencing depends upon this “overlap” between sequenced DNA fragments to assemble complete genomic DNA sequences.

Microsatellite DNA Polymorphisms

Short (2–6 bp), inherited, tandem repeat units of DNA occur about 50,000 to 100,000 times in the human genome (Chapter 35). Because they occur more frequently—and in view of the routine application of sensitive PCR methods—they are replacing RFLPs as the marker loci for various genome searches.

RFLPs & VNTRs in Forensic Medicine

Variable numbers of tandemly repeated (VNTR) units are one common type of “insertion” that results in an RFLP. The VNTRs can be inherited, in which case they are useful in establishing genetic association with a disease in a family or kindred; or they can be unique to an individual and thus serve as a molecular fingerprint of that person.

Direct Sequencing of Genomic DNA

As noted above, recent advances in DNA sequencing technology, the so-called next generation (NGS), or high throughput (HTS) sequencing platforms, have dramatically reduced the per base cost of DNA sequencing. The initial sequence of the human genome cost roughly \$350,000,000 (US). The cost of sequencing the same 3×10^9 bp diploid human genome using the new NGS platforms is estimated to be <0.03% of the original. Very recently the technology has been developed to allow for human genome sequencing for \$1000 (US). This dramatic reduction in cost has stimulated various international initiatives to sequence the entire genomes of thousands of individuals of various racial and ethnic backgrounds in order to determine the true extent of DNA/genome polymorphisms present within the population. The resulting cornucopia of genetic information, and the ever-decreasing cost of genomic DNA sequencing is dramatically increasing our ability to diagnose and, ultimately treat human disease. Obviously, when personal genome sequencing does become commonplace, dramatic changes in the practice of medicine will result because therapies will ultimately be custom tailored to the exact genetic makeup of each individual.

Gene Therapy and Stem Cell Biology

Diseases caused by deficiency of a single gene product (Table 39–4) are all theoretically amenable to replacement therapy. The strategy is to clone a normal copy of the relevant gene (eg, the gene that codes for adenosine deaminase) into a vector that will readily be taken up and incorporated into the genome of a host cell. Bone marrow precursor cells are being investigated for this purpose because they presumably will resettle in the marrow and replicate there. The introduced gene would begin to direct the expression of its protein product, and this would correct the deficiency in the host cell.

As an alternative to “replacing” defective genes to cure human disease, many scientists are investigating the feasibility of identifying and characterizing pluripotent stem cells that have the ability to differentiate into any cell type in the body. Recent results in this field have shown that adult human somatic cells can readily be converted into apparent **induced pluripotent stem cells (iPSCs)** by transfection with cDNAs encoding a handful of DNA binding transcription factors. These and other new developments in the fields of gene therapy and stem cell biology promise exciting new potential therapies for curing human disease. Finally, generating iPSCs from diseased patient

cells also offer the opportunity to create authentic models for laboratory studies of the molecular basis of human disease.

Transgenic Animals

The somatic cell gene replacement therapy described above would obviously not be passed on to offspring. Other strategies to alter germ cell lines have been devised but have been tested only in experimental animals. A certain percentage of genes injected into a fertilized mouse ovum will be incorporated into the genome and found in both somatic and germ cells. Hundreds of transgenic animals have been established, and these are useful for analysis of tissue-specific effects on gene expression and effects of overproduction of gene products (eg, those from the growth hormone gene or oncogenes) and in discovering genes involved in development—a process that heretofore has been difficult to study in mammals. The transgenic approach has been used to correct a genetic deficiency in mice. Fertilized ova obtained from mice with genetic hypogonadism were injected with DNA containing the coding sequence for the gonadotropin-releasing hormone (GnRH) precursor protein. This gene was expressed and regulated normally in the hypothalamus of a certain number of the resultant mice, and these animals were in all respects normal. Their offspring also showed no evidence of GnRH deficiency. This is, therefore, evidence of somatic cell expression of the transgene and of its maintenance in germ cells.

Targeted Gene Regulation by Disruption or Knockout, Knockin, Editing, and Controlled Expression

Various technical advances have allowed for the precise, targeted modification of mammalian genes. The exact methods used for genetically engineering mammalian genomes have evolved from tedious, low efficiency methods based upon positive and negative drug selections and homologous recombination (Knockout/Knockin) to the recently described CRISPR-Cas9 system described above. The goal of all of these methods is ultimately to generate a family of genetic variants of a gene of interest that are: (a) a null, or complete loss-of-function allele; (b) recessive, loss-of-function alleles; and (c) ideally, dominant gain-of function alleles. These genetic alterations are generated in pluripotent stem cells, which ultimately allow for introduction and propagation in whole model organisms (flies, fish, worms, rodents, etc). Having all three of these genetic variants allows one to precisely dissect the mechanism of action of any gene. However, complicating genetic analyses of many genes is the fact that their function(s) are essential for viability. To get around this problem cell-type or tissue-specific genetic variants must be generated. This hurdle has been overcome through the use of cell- and tissue-specific enhancers that can drive the conditional (ie, experimentally controlled) expression of the targeting recombinases (ie, CRE-lox) and/or

or nuclease (CRISPR-Cas) that generate the altered genes, either null or loss- or gain-of-function alleles. Alternatively, selected loss-of-function can be generated through equivalent siRNA expression to knock down production of a specific gene product. Collectively these methods allow for sophisticated genetic and biochemical tests of gene function and allow scientists to probe the structure and function of mammalian genes in physiological contexts. Tremendous molecular mechanistic insights have been, and will continue to be, obtained into the molecular etiology of human disease through these and other biochemical approaches. Exciting times lie ahead!

RNA and Protein Profiling, and Protein–DNA Interaction Mapping

The “-omic” revolution of the last decade has culminated in the determination of the complete nucleotide sequence of tens of thousands of genomes, including those of budding and fission yeasts, numerous bacteria, the fruit fly, the worm *Caenorhabditis elegans*, plants, the mouse, rat, chicken, monkey and, most notably, humans. Additional genomes are being sequenced at an accelerating pace. The availability of all of this DNA sequence information, coupled with engineering advances, has led to the development of several revolutionary methodologies, most of which are based upon **high-density microarray technology** or **NGS sequencing** platforms. In the case of microarrays, it is now possible to deposit thousands of specific, known, defined DNA sequences on a glass microscope-style slide, or other inert support, in the space of a few square centimeters. By coupling such DNA microarrays with highly sensitive detection of hybridized fluorescently labeled nucleic acid probes derived from mRNA, investigators can rapidly and accurately generate profiles of gene expression (eg, specific cellular mRNA content) from cell and tissue samples as small as 1 g or less. Thus, entire **transcriptome information** (the entire collection of cellular RNAs) for such cell or tissue sources can readily be obtained in only a few days. In the case of NGS sequencing, mRNAs are converted to cDNAs using reverse transcription, and these cDNAs are amplified and directly sequenced; this method is termed **RNA-Seq**. These methods allow for the quantitative description of the entire transcriptome. Recent reports in the literature have used RNA-Seq to describe the transcriptome of single cells, and when coupled with high sensitivity mass spectrometry-based proteomics (see below) confidently define gene expression profiles.

Recent methodological advances (**GRO-Seq**, Global Run-On sequencing, and **NET-seq**, native elongating transcript sequencing) allow for sequencing of RNA within elongating RNA polymerase-DNA-RNA ternary complexes, thereby allowing nucleotide-level descriptions, genome-wide, of transcription in living cells. Such transcriptome information allows one to quantitatively predict the collection of proteins that might be expressed in a particular cell, tissue, or organ in normal and disease states based upon the mRNAs present in those cells.

Complementing the very high-throughput, transcript-profiling methods described above is the recent development of methods to map the location, or occupancy of specific proteins bound to discrete DNA sequences within living cells. This method, illustrated in **Figure 39–11**, is termed **chromatin immunoprecipitation (ChIP)**. Proteins are cross-linked in situ in cells or tissues, the cellular chromatin is isolated, sheared, and specific cross-linked protein-DNA complexes purified using antibodies that recognize a particular protein, or protein isoform. DNA bound to this protein is recovered and amplified using PCR and analyzed: either using gel electrophoresis, microarray hybridization analysis (**ChIP-chip**), or direct sequencing. There are two versions of the DNA sequencing assay readout. In the first the immunopurified DNA is directly subjected to NGS/high throughput DNA sequencing (**ChIP-Seq**); in the second version, the immunopurified, cross-linked protein-DNA complex is treated with exonucleases to remove cross-linked DNA sequences that are not in intimate contact with the protein of interest; this is termed **ChIP-Exo**. Collectively ChIP-chip and ChIP-Seq methods allow investigators to identify the locations of a single protein genome-wide throughout all the chromosomes. ChIP-Exo has the added advantage of allowing investigators to map in vivo protein occupancy at single nucleotide-level resolution. Finally, methods for high-sensitivity, high-throughput mass spectrometry of metabolites (**metabolomics**), various small molecules (lipids, **lipidomics**; carbohydrates, **glycomics**, etc) and complex protein samples (**proteomics**) have been developed. Newer mass spectrometry methods allow scientists to identify hundreds to thousands of proteins in complex samples extracted from very small numbers of cells (<1 g). Such analyses can now be used to quantify the relative amounts of proteins in two samples, as well as the level of certain PTMs, such as phosphorylation, acetylation etc; and with the use of specific antibodies, define specific protein-protein interactions. This critical information tells investigators which of the many mRNAs detected in transcriptome mapping studies are actually translated into protein, generally the ultimate dictator of phenotype.

New genetic means for identifying protein-protein interactions and protein function have also been devised. Systematic genome-wide gene expression knockdown using siRNAs, synthetic lethal genetic interaction screens, or most recently CRISPR-Cas9 knockdown have been used to assess the contribution of individual genes to a variety of processes in model systems (yeast, worms, and flies) and mammalian cells (human and mouse). Specific network mappings of protein-protein interactions, on a genome-wide basis, have been identified using high-throughput variants of the **two-hybrid interaction** test (**Figure 39–12**). This simple yet powerful method can be performed in bacteria, yeast, or metazoan cells, and allows for detecting specific protein-protein interactions in living cells. Reconstruction experiments indicate that protein-protein interactions with affinities of $K_d \sim 10^{-6}$ mol/L or tighter can readily be detected with this method. Together, these technologies provide powerful tools with which to dissect the intricacies of human biology.

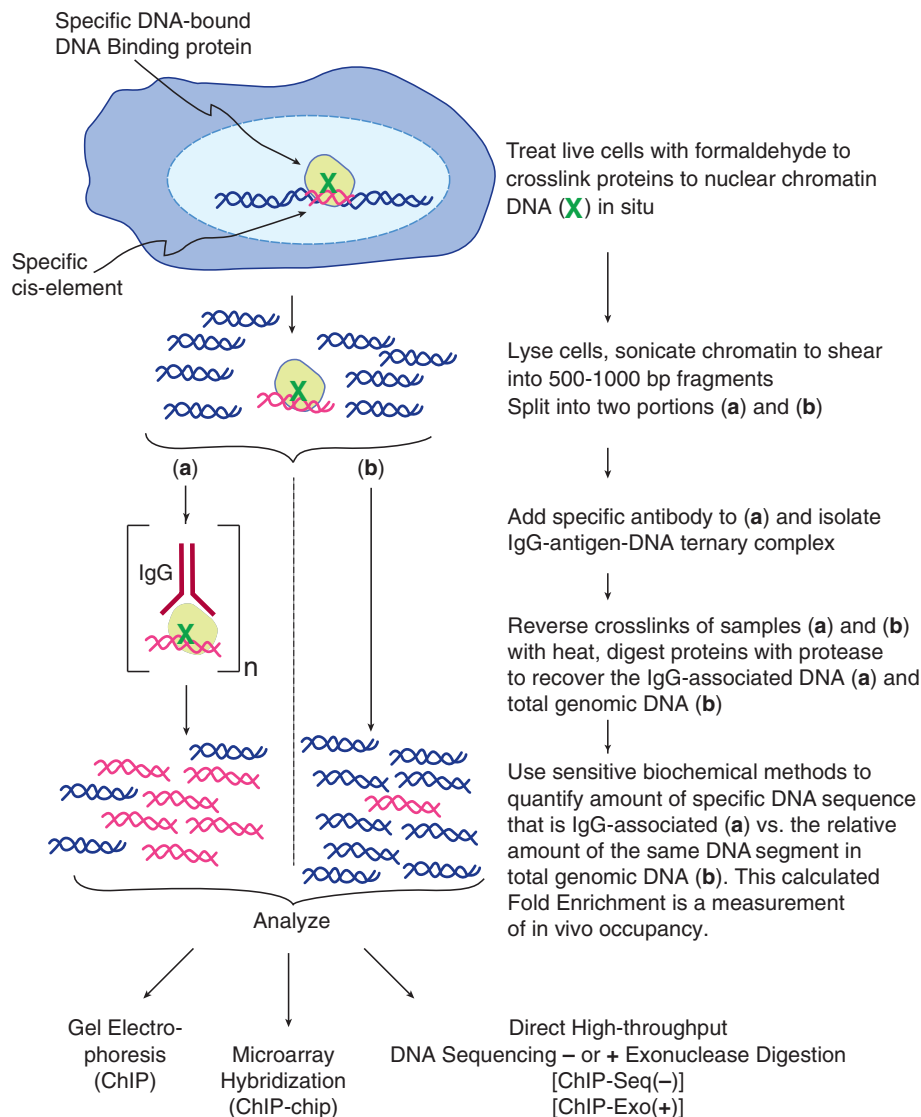

FIGURE 39-11 Outline of the chromatin immunoprecipitation (ChIP) technique. This method allows for the precise localization of a particular protein (or modified protein if an appropriate antibody is available; eg, phosphorylated or acetylated histones, transcription factors, etc) on a particular sequence element in living cells. Depending upon the method used to analyze the immunopurified DNA, quantitative or semiquantitative information, at near nucleotide level resolution, can be obtained. Protein-DNA occupancy can be scored genome-wide in two ways. First, by ChIP-chip, a method that uses a hybridization readout. In ChIP-chip total genomic DNA is labeled with one particular fluorophore and the immunopurified DNA is labeled with a spectrally distinct fluorophore. These differentially labeled DNAs are mixed and hybridized to microarray “chips” (microscope slides) that contain specific DNA fragments, or more commonly now, synthetic oligonucleotide 50 to 70 nucleotides long. These gene-specific oligonucleotides are deposited and covalently attached at predetermined, known X,Y position/coordinates on the slide. The labeled DNAs are hybridized, the slides washed and hybridization to each gene-specific oligonucleotide probe is scored using differential laser scanning and sensitive photodetection at micron resolution. The hybridization signal intensities are quantified and the ratio of IP DNA/genomic DNA signals is used to score occupancy levels. The second method, termed ChIP-Seq, directly sequences immunopurified DNAs using NGS sequencing methods. Two variants of ChIP-Seq are shown: “standard” ChIP-Seq and ChIP-Exo. These two approaches differ in their ability to resolve and map the locations of the bound protein on genomic DNA. Standard ChIP-Seq resolution is $\sim \pm 50$ nt resolution, while ChIP-Exo has near single nt level resolution. Both approaches rely upon efficient bioinformatic algorithms to deal with the very large datasets that are generated. ChIP-chip and ChIP-Seq techniques provide a (semi-) quantitative measure of in vivo protein occupancy. Though not schematized here, similar methods termed RIP (RNA immunoprecipitation) or CLIP (crosslinking protein-RNA and immunoprecipitation), which differ primarily in the method of protein-RNA crosslinking, can score the in vivo binding of specific proteins to specific RNA species (typically mRNAs, though any RNA species can be analyzed by these techniques).

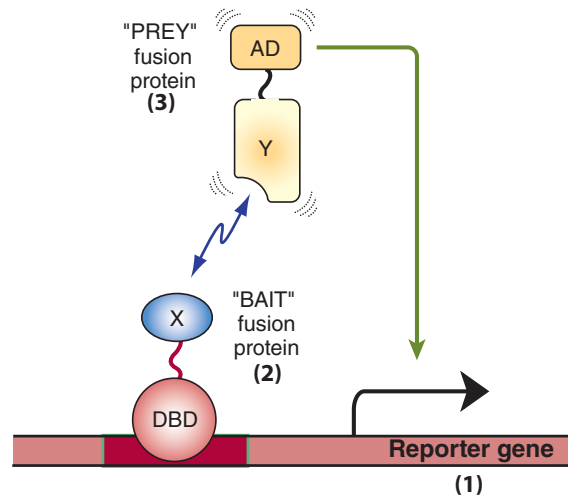

FIGURE 39–12 Overview of two hybrid system for identifying and characterizing protein–protein interactions. Shown are the basic components and operation of the two hybrid systems, originally devised by Fields and Song (Nature 340:245–246 [1989]) to function in the baker’s yeast system. **(1)** A reporter gene, either a selectable marker (ie, a gene conferring prototrophic growth on selective media, or producing an enzyme for which a colony colorimetric assay exists, such as β -galactosidase) that is expressed only when a transcription factor binds upstream to a *cis*-linked enhancer (dark red bar). **(2)** A “bait” fusion protein (**DBD-X**) produced from a chimeric gene expressing a modular DNA binding domain (**DBD**; often derived from the yeast Gal 4 protein or the bacterial Lex A protein, both high-affinity, high-specificity DNA binding proteins) fused in-frame to a protein of interest, here X. In two hybrid experiments, one is testing whether any protein can interact with protein X. Prey protein X may be fused in its entirety or often alternatively just a portion of protein X is expressed in-frame with the DBD. **(3)** A “prey” protein (**Y-AD**), which represents a fusion of a specific protein fused in-frame to a transcriptional activation domain (**AD**; often derived from either the *Herpes simplex* virus VP16 activator protein or the yeast GAL4 protein). This system serves as a useful test of protein–protein interactions between proteins X and Y because in the absence of a functional transactivator binding to the indicated enhancer, no transcription of the reporter gene occurs (ie, see Figure 38–16). Thus, one observes transcription only if protein X–protein Y interaction occurs, thereby bringing a functional AD to the *cis*-linked transcription unit, in this case activating transcription of the reporter gene. In this scenario, protein DBD-X alone fails to activate reporter transcription because the X-domain fused to the DBD does not contain an AD. Similarly, protein Y-AD alone fails to activate reporter gene transcription because it lacks a DBD to target the Y-AD protein to the enhancer–promoter–reporter gene. Only when both proteins are expressed in a single cell and bind the enhancer and, via DBD-X–Y-AD protein–protein interactions, regenerate a functional transactivator binary “protein,” does reporter gene transcription result in activation and mRNA synthesis (green line from AD to reporter gene).

SYSTEMS BIOLOGY AIMS TO INTEGRATE THE FLOOD OF –OMIC DATA IN ORDER TO DECIPHER FUNDAMENTAL BIOLOGICAL REGULATORY PRINCIPLES

Microarray techniques, high-throughput genomic DNA sequencing, ChIP-Seq genome-wide two-hybrid genetic knockdown, and synthetic lethal screens coupled with mass spectrometric protein and metabolite identification experiments have led to the generation of enormous amounts of data. Appropriate data management and interpretation of the deluge of information forthcoming from such studies have relied upon the application of statistical methods and novel algorithms for analyzing or “mining” and visualizing such huge datasets, and has led to the development of the field of **bioinformatics** (see also Chapter 11). These new technologies, coupled with the flood of experimental data, has further led to the development of the field of **systems biology**, a discipline whose goal is to quantitatively analyze, and integrate

this flood of biologically important information. Future work at the intersection of bioinformatics, engineering, biophysics, genetics, transcript-protein/PTM profiling, and systems biology will revolutionize our understanding of physiology and medicine and ultimately human health.

SUMMARY

- In DNA cloning, a particular segment of DNA is either directly synthesized, or is removed from its normal environment using PCR or one of many DNA-directed endonucleases. Such DNA is then ligated into a vector in which the DNA segment can be amplified and produced in abundance.
- Manipulation of the DNA to change its structure, so-called genetic engineering, is a key element in cloning (eg, the construction of chimeric molecules) and can also be used to study the function of a certain fragment of DNA and to analyze how genes are regulated.
- A variety of very sensitive techniques can now be applied to the isolation and characterization of genes and to the quantitation of gene products in both static (ie, equilibrium) and dynamic (kinetic) modes. These methods allow for the identification of the genes responsible for diseases, and for the study of how faulty gene/gene regulation causes disease.

- Mammalian genomes can now be precisely engineered to knockin (add/replace a gene), knockout (delete or inactivate) and/or actively and conditionally manipulate specific genes using novel genome editing enzymes (recombinases) and enzyme-RNA systems (CRISPR-Cas).

REFERENCES

- Abecasis GR, Auton A, Brooks LD, et al: The 1000 Genomes Project Consortium. An integrated map of genetic variation from 1,092 human genomes. *Nature* 2012;491:56–65.
- Brass AL, Dykxhoorn DM, Benita Y, et al: Identification of host proteins required for HIV infection through a functional genomic screen. *Science* 2008;319:921.
- Churchman LS, Weissman JS: Nascent transcript sequencing visualizes transcription at nucleotide resolution. *Nature* 2011;469:368–373.
- Core LJ, Waterfall JJ, Lis JT: Nascent RNA sequencing reveals widespread pausing and divergent initiation at human promoters. *Science* 2008;322:1845–1848.
- Costanzo M, Baryshnikova A, Myers CL, et al: Charting the genetic interaction map of a cell. *Curr Opin Biotechnol* 2011 Feb;22(1):66–74.
- Deng Q, Ramsköld D, Reinius B, et al: Single-cell RNA-seq reveals dynamic, random monoallelic gene expression in mammalian cells. *Science* 2014;343:193–196.
- Denny JC, Bastarache L, Ritchie MD, et al: Systematic comparison of phenome-wide association study of electronic medical record data and genome-wide association study data. *Nat Biotechnol* 2013;31:1102–1111.
- Gandhi TK, Zhong J, Mathivanan S, et al: Analysis of the human protein interactome and comparison with yeast, worm and fly interaction datasets. *Nat Genet* 2006;38:285.
- Gibson DG, Glass JI, Lartigue C, et al: Creation of a bacterial cell controlled by a chemically synthesized genome. *Science* 2010;329:52–56.
- Gilchrist DA, Fargo DC, Adelman K: Using ChIP-chip and ChIP-seq to study the regulation of gene expression: genome-wide localization studies reveal widespread regulation of transcription elongation. *Methods* 2009;48:398–408.
- Green, MR, Sambrook J: *Molecular Cloning: A Laboratory Manual*. Fourth Edition, Cold Spring Harbor Laboratory Press, 2012.
- Horvath P, Barrangou R: CRISPR/Cas, the immune system of bacteria and archaea. *Science* 2010;327:167–170.
- Isaacs FJ, Carr PA, Wang HH, et al: Precise manipulation of chromosomes in vivo enables genome-wide codon replacement. *Science* 2011;333:348–353.
- Kodzius R, Kojima M, Nishiyori H, et al: CAGE: cap analysis of gene expression. *Nat Meth* 2006;3:211–222.
- Liebler DC, Zimmerman LJ: Targeted quantitation of proteins by mass spectrometry. *Biochemistry* 2013;52:3797–3806.
- Martin JB, Gusella JF: Huntington's disease: pathogenesis and management. *N Engl J Med* 1986;315:1267.
- Myers RM, Stamatoyannopoulos J, Snyder M, et al: A user's guide to the encyclopedia of DNA elements (ENCODE). *PLoS Biol* 2011;9:e1001046.
- Petrocca F, Altschuler G, Tan SM, et al: A genome-wide siRNA screen identifies proteasome addiction as a vulnerability of basal-like triple-negative breast cancer cells. *Cancer Cell* 2013;24:182–196.
- Sampson TR, Weiss DS: Exploiting CRISPR/Cas systems for biotechnology. *Bioessays* 2014;36:34–38.
- Plass C, Pfister SM, Lindroth AM, et al: Mutations in regulators of the epigenome and their connections to global chromatin patterns in cancer. *Nat Rev Genet*. 2013 Nov;14(11):765–780.
- Rhee HS, Pugh BF: Comprehensive genome-wide protein-DNA interactions detected at single-nucleotide resolution. *Cell* 2011;147:1408–1419.
- Takahashi K, Tanabe K, Ohnuki M, et al: Induction of pluripotent stem cells from adult human fibroblasts by defined factors. *Cell* 2007;131:861.
- Telese F, Gamliel A, Skowronska-Krawczyk D: “Seq-ing” insights into the epigenetics of neuronal gene regulation. *Neuron* 2013;77:606–623.
- Wang L, Wheeler DA: Genomic sequencing for cancer diagnosis and therapy. *Ann Rev Medicine* 2014;65:25.1–25.16.
- Wang T, Wei JJ, Sabatini DM, Lander ES: Genetic screens in human cells using the CRISPR-Cas9 system. *Science* 2014;343:80–84.
- Weatherall DJ: *The New Genetics and Clinical Practice*, 3rd ed. Oxford University Press, 1991.
- Wernig M, Meissner A, Foreman R, et al: In vitro reprogramming of fibroblasts into a pluripotent ES-cell-like state. *Nature* 2007;448:318.
- Wheeler DA, Srinivasan M, Egholm M, et al: The complete genome of an individual by massively parallel DNA sequencing. *Nature* 2008;451:872.

GLOSSARY

ARS: Autonomously replicating sequence; the origin of replication in yeast.

Autoradiography: The detection of radioactive molecules (eg, DNA, RNA, and protein) by visualization of their effects on photographic or x-ray film.

Bacteriophage: A virus that infects a bacterium.

Blunt-ended DNA: Two strands of a DNA duplex having ends that are flush with each other.

CAGE: Cap analysis of gene expression. A method that allows the selective capture, amplification, cloning, and sequencing of mRNAs via the 5'-Cap structure.

cDNA: A single-stranded DNA molecule that is complementary to an mRNA molecule and is synthesized from it by the action of reverse transcriptase.

Chimeric molecule: A molecule (eg, DNA, RNA, and protein) containing sequences derived from two different species.

ChIP, chromatin immunoprecipitation: A technique that the determination of the exact localization of a particular protein, or protein isoform, on any particular genomic location in a living cell. The method is based upon cross-linking of living cells, cell disruption, DNA fragmentation, and immunoprecipitation with specific antibodies that purify the cognate protein cross-linked to DNA. Cross-links are reversed, associated DNA purified and specific sequences that are purified are measured using any of several different methods.

ChIP-chip, chromatin immunoprecipitation assayed via a microarray chip hybridization read-out: A hybridization-based method that uses chromatin immunoprecipitation (ChIP) techniques to map, genome-wide, the in vivo sites of binding of specific proteins within chromatin in living cells. Sequence-binding is determined by annealing fluorescently labeled DNA samples to microarrays (array).

ChIP-Exo, chromatin immunoprecipitation assayed via a NGS/deep sequencing readout after treatment of immunoprecipitated

- protein-DNA complexes with exonucleases.** A variation on ChIP-Seq (see below) that allows nucleotide-level precision in the mapping and description of DNA cis-elements bound by a particular protein.
- ChIP-Seq, chromatin immunoprecipitation assayed via a NGS sequencing read-out:** Genomic DNA binding location in a ChIP determined by high-throughput sequencing, rather than hybridization to microarrays.
- CLIP: a method that uses UV crosslinking to induce covalent attachment of distinct proteins to specific RNAs in vivo.** RNAs that are protein-bound can subsequently be purified from cell lysates by immunoprecipitation and subsequent sequencing.
- Clone:** A large number of organisms, cells or molecules that are identical with a single parental organism cell or molecule.
- Copy number variation (CNV):** Change in the copy number of specific genomic regions of DNA between two or more individuals. CNVs can be as large as 10^6 bp of DNA and include deletions or insertions.
- Cosmid:** A plasmid into which the DNA sequences from bacteriophage lambda that are necessary for the packaging of DNA (λ *cos* sites) have been inserted; this permits the plasmid DNA to be packaged in vitro.
- CRISPER/Cas:** A prokaryotic 'immune system' conferring resistance to external genes from bacteriophage. This system provides a bacterial version of acquired immunity. CRISPR (Clustered Regularly Interspaced Short Palindromic Repeats) spacer-derived RNA combines with the Cas nuclease to target and specifically cleave the DNA of invading phage, thereby inactivating these invading genomes and protecting the bacterium from productive phage infection and lysis.
- ENCODE project:** Encyclopedia of DNA elements project; an effort of multiple laboratories throughout the world to provide a detailed, biochemically informative representation of the human genome using high-throughput sequencing methods to identify and catalog the functional elements within the human genome.
- Endonuclease:** An enzyme that cleaves internal bonds in DNA or RNA.
- Epigenetic code:** The patterns of modification of chromosomal DNA (ie, cytosine methylation) and nucleosomal histone posttranslational modifications. These changes in modification status can lead to dramatic alterations in gene expression. Notably though, the actual underlying DNA sequence involved does not change.
- Excinuclease:** The excision nuclease involved in nucleotide exchange repair of DNA.
- Exome:** The nucleotide sequence of the entire complement of mRNA exons expressed in a particular cell, tissue, organ or organism. The exome differs from the transcriptome that represents the entire collection of genome transcripts; the exome represents a subset of the RNA sequences composing the transcriptome.
- Exon:** The sequence of a gene that is represented (expressed) as mRNA.
- Exonuclease:** An enzyme that cleaves nucleotides from either the 3' or 5' ends of DNA or RNA.
- Fingerprinting:** The use of RFLPs or repeat sequence DNA to establish a unique pattern of DNA fragments for an individual.
- FISH:** Fluorescence in situ hybridization, a method used to map the location of specific DNA sequences within fixed nuclei.
- Footprinting:** DNA with protein bound is resistant to digestion by DNase enzymes. When a sequencing reaction is performed using such DNA, a protected area, representing the "footprint" of the bound protein, will be detected because nucleases are unable to cleave the DNA directly bound by the protein.
- GRO-Seq, global run-on sequencing:** A method where nascent transcripts are specifically captured and sequenced using NGS sequencing. This methods allows for the mapping of the location of active transcription complexes.
- Hairpin:** A double-helical stretch formed by base pairing between neighboring complementary sequences of a single strand of DNA or RNA.
- Hybridization:** The specific reassociation of complementary strands of nucleic acids (DNA with DNA, DNA with RNA, or RNA with RNA).
- Insert:** An additional length of base pairs in DNA, generally introduced by the techniques of recombinant DNA technology.
- Intron:** The sequence of an mRNA-encoding gene that is transcribed but excised before translation. tRNA genes can also contain introns.
- Library:** A collection of cloned fragments that represents, in aggregate, the entire genome. Libraries may be either genomic DNA (in which both introns and exons are represented) or cDNA (in which only exons are represented).
- Ligation:** The enzyme-catalyzed joining in phosphodiester linkage of two stretches of DNA or RNA into one; the respective enzymes are DNA and RNA ligases.
- Lines:** Long interspersed repeat sequences.
- Microsatellite polymorphism:** Heterozygosity of a certain microsatellite repeat in an individual.
- Microsatellite repeat sequences:** Dispersed or group repeat sequences of 2 to 5 bp repeated up to 50 times. May occur at 50 to 100 thousand locations in the genome.
- miRNAs:** MicroRNAs, 21 to 22 nucleotide long RNA species derived from RNA polymerase II transcription units, and 500 to 1500 bp in length via RNA processing. These RNAs play crucial roles in gene regulation by altering mRNA function.
- NET-seq, native elongating sequencing:** Genome-wide analysis of eukaryotic mRNA nascent chain 3'-ends mapped at nucleotide-level resolution. RNA Polymerase II elongation complexes are captured by immunopurification with anti-Pol II antibodies and nascent RNAs containing a free 3' OH group are tagged via ligation with an RNA linker and subsequently amplified by PCR and subjected to NGS sequencing.
- Nick translation:** A technique for labeling DNA based on the ability of the DNA polymerase from *E coli* to degrade a strand of DNA that has been nicked and then to resynthesize the strand; if a radioactive nucleoside triphosphate is employed, the rebuilt strand becomes labeled and can be used as a radioactive probe.
- Northern blot:** A method for transferring RNA from an agarose or polyacrylamide gel to a nitrocellulose or nylon filter, upon which the RNA can be detected by a suitable probe by base-specific hybridization.
- Oligonucleotide:** A short, defined sequence of nucleotides joined together in the typical phosphodiester linkage.
- Ori:** The origin of DNA replication.
- PAC:** A high-capacity (70-95 kb) cloning vector based upon the lytic *E coli* bacteriophage P1 that replicates in bacteria as an extrachromosomal element.
- Palindrome:** A sequence of duplex DNA that is the same when the two strands are read in opposite directions.

- Plasmid:** A small, extrachromosomal, circular molecule of DNA, or episome, that replicates independently of the host DNA.
- Polymerase chain reaction (PCR):** An enzymatic method for the repeated copying (and thus amplification) of the two strands of DNA that make up a particular gene sequence.
- Primosome:** The mobile complex of helicase and primase that is involved in DNA replication.
- Probe:** A molecule used to detect the presence of a specific fragment of DNA or RNA in, for instance, a bacterial colony that is formed from a genetic library or during analysis by blot transfer techniques; common probes are cDNA molecules, synthetic oligodeoxynucleotides of defined sequence, or antibodies to specific proteins.
- Proteome:** The entire collection of expressed proteins in an organism.
- Pseudogene:** An inactive segment of DNA arising by mutation of a parental active gene; typically generated by transposition of a cDNA copy of an mRNA.
- Recombinant DNA:** The altered DNA that results from the insertion of a sequence of deoxynucleotides not previously present into an existing molecule of DNA by enzymatic or chemical means.
- Restriction enzyme:** An endodeoxynuclease that causes cleavage of both strands of DNA at highly specific sites dictated by the base sequence.
- Reverse transcription:** RNA-directed synthesis of DNA catalyzed by reverse transcriptase.
- RNA-Seq:** A method where cellular RNA populations are converted, via linker ligation and PCR into cDNAs that are then subjected to deep sequencing to determine the complete sequence of essentially all RNAs in the preparation.
- RIP: An RNA immunoprecipitation method, performed like ChIP, which is used to score specific binding of a protein to a specific RNA in vivo.** RIP uses formaldehyde crosslinking to induce covalent attachment of proteins to RNA (see also CLIP).
- RT-PCR:** A method used to quantitate mRNA levels that relies upon a first step of cDNA copying of mRNAs catalyzed by reverse transcriptase prior to PCR amplification and quantitation.
- Signal:** The end product observed when a specific sequence of DNA or RNA is detected by autoradiography or some other method. Hybridization with a complementary radioactive polynucleotide (eg, by Southern or Northern blotting) is commonly used to generate the signal.
- Sines:** Short interspersed repeat sequences.
- siRNAs:** Silencing RNAs, 21 to 25 nt in length generated by selective nucleolytic degradation of double-stranded RNAs of cellular or viral origin. siRNAs anneal to various specific sites within target in RNAs leading to mRNA degradation, hence gene “knockdown.”
- SNP:** Single nucleotide polymorphism. Refers to the fact that single nucleotide genetic variation in genome sequence exists at discrete loci throughout the chromosomes. Measurement of allelic SNP differences is useful for gene mapping studies.
- snRNA:** Small nuclear RNA. This family of RNAs is best known for its role in mRNA processing.
- Southern blot:** A method for transferring DNA from an agarose gel to nitrocellulose filter, on which the DNA can be detected by a suitable probe (eg, complementary DNA or RNA).
- Southwestern blot:** A method for detecting protein-DNA interactions by applying a labeled DNA probe to a transfer membrane that contains a renatured protein.
- Spliceosome:** The macromolecular complex responsible for precursor mRNA splicing. The spliceosome consists of at least five small nuclear RNAs (snRNA; U1, U2, U4, U5, and U6) and many proteins.
- Splicing:** The removal of introns from RNA accompanied by the joining of its exons.
- Sticky-ended DNA:** Complementary single strands of DNA that protrude from opposite ends of a DNA duplex or from the ends of different duplex molecules (see also Blunt-ended DNA, above).
- Tandem:** Used to describe multiple copies of the same sequence (eg, DNA) that lie adjacent to one another.
- Terminal transferase:** An enzyme that adds nucleotides of one type (eg, deoxyadenonucleotidyl residues) to the 3' end of DNA strands.
- Transcription:** Template DNA-directed synthesis of nucleic acids, typically DNA-directed synthesis of RNA.
- Transcriptome:** The entire collection of expressed RNAs in a cell, tissue, organ, or organism; includes both mRNAs and ncRNAs.
- Transgenic:** Describing the introduction of new DNA into germ cells by its injection into the nucleus of the ovum.
- Translation:** Synthesis of protein using mRNA as template.
- Vector:** A plasmid or bacteriophage into which foreign DNA can be introduced for the purposes of cloning.
- Western blot:** A method for transferring protein to a nitrocellulose filter, on which the protein can be detected by a suitable probe (eg, an antibody).

Exam Questions

Section VII – Structure, Function, & Replication of Informational Macromolecules

- Which of the following statements about β,γ -methylene and β,γ -imino derivatives of purine and pyrimidine triphosphates is CORRECT?
 - They are potential anticancer drugs.
 - They are precursors of B vitamins.
 - They readily undergo hydrolytic removal of the terminal phosphate.
 - They can be used to implicate involvement of nucleotide triphosphates by effects other than phosphoryl transfer.
 - They serve as polynucleotide precursors.
- Which of the following statements about nucleotide structures is NOT CORRECT?
 - Nucleotides are polyfunctional acids.
 - Caffeine and theobromine differ structurally solely with respect to the number of methyl groups attached to their ring nitrogens.
 - The atoms of the purine ring portion of pyrimidines are numbered in the same direction as those of a pyrimidine.
 - NAD⁺, FMN, “active methionine” and coenzyme A all are derivatives of ribonucleotides.
 - 3',5'-Cyclic AMP and GMP (cAMP and cGMP) serve as second messengers in human biochemistry.
- Which of the following statements about purine nucleotide metabolism is NOT CORRECT?
 - An early step in purine biosynthesis is the formation of PRPP (phosphoribosyl 1-pyrophosphate).
 - Inosine monophosphate (IMP) is a precursor of both AMP and GMP.
 - Orotic acid is an intermediate in pyrimidine nucleotide biosynthesis.
 - Humans catabolize uridine and pseudouridine by analogous reactions.
 - Ribonucleotide reductase converts nucleoside diphosphates to the corresponding deoxyribonucleoside diphosphates.
- Which of the following statements is NOT CORRECT?
 - Metabolic disorders are only infrequently associated with defects in the catabolism of purines.
 - Immune dysfunctions are associated both with a defective adenosine deaminase and with a defective purine nucleoside phosphorylase.
 - The Lesch-Nyhan syndrome reflects a defect in hypoxanthine-guanine phosphoribosyl transferase.
 - Xanthine lithiasis can be due to a severe defect in xanthine oxidase.
 - Hyperuricemia can result from conditions such as cancer characterized by enhanced tissue turnover.
- Which of the following components are found in DNA?
 - A phosphate group, adenine, and ribose
 - A phosphate group, guanine, and deoxyribose
 - Cytosine and ribose
 - Thymine and deoxyribose
 - A phosphate group and adenine
- The backbone of a DNA molecule consists of which of the following?
 - Alternating sugars and nitrogenous bases
 - Nitrogenous bases alone
 - Phosphate groups alone
 - Alternating phosphate and sugar groups
 - Five carbon sugars alone
- The interconnecting bonds that connecting the nucleotides of RNA and DNA are termed:
 - N*-glycosidic bonds
 - 3'-5'-phosphodiester linkages
 - Phosphomonoesters
 - 2'-phosphodiester linkages
 - Peptide nucleic acid bonds
- Which component of the DNA duplex causes the molecule to have a net negative charge at physiological pH?
 - Deoxyribose
 - Ribose
 - Phosphate groups
 - Chlorine ion
 - Adenine
- Which molecular feature listed causes duplex DNA to exhibit a near constant width along its long axis?
 - A purine nitrogenous base always pairs with another purine nitrogenous base.
 - A pyrimidine nitrogenous base always pairs with another pyrimidine nitrogenous base.
 - A pyrimidine nitrogenous base always pairs with a purine nitrogenous base.
 - Repulsion between phosphate groups keeps the strands a uniform distance apart.
 - Attraction between phosphate groups keeps the strands a uniform distance apart.
- The model for DNA replication first proposed by Watson and Crick's posited that every newly replicated double stranded daughter duplex DNA molecule.
 - Was composed of the two strands from the parent DNA molecule
 - Contained solely the two newly synthesized strands of DNA
 - Contained two strands that are random mixtures of new and old DNA within each strand
 - Was composed of one strand derived from the original parental DNA duplex and one strand that was newly synthesized
 - Was composed of nucleotide sequences completely distinct from either parental DNA strand

11. Name the mechanism through which RNAs are synthesized from DNA.
 - A. Replicational duplication
 - B. Translation
 - C. Translesion repair
 - D. Transesterification
 - E. Transcription
12. Which of the forces or interactions listed below play the predominant role in driving RNA secondary and tertiary structure formation?
 - A. Hydrophilic repulsion
 - B. Formation of complementary base pair regions
 - C. Hydrophobic interaction
 - D. van der Waals interactions
 - E. Salt bridge formation
13. Name the enzyme that synthesizes RNA from a double stranded DNA template.
 - A. RNA-dependent RNA polymerase
 - B. DNA-dependent RNA convertase
 - C. RNA-dependent replicase
 - D. DNA-dependent RNA polymerase
 - E. Reverse transcriptase
14. Define the most notable characteristic difference with regard to gene expression between eukaryotes and prokaryotes.
 - A. Ribosomal RNA nucleotide lengths
 - B. Mitochondria
 - C. Lysosomes and peroxisomes
 - D. Sequestration of the genomic material in the nucleus
 - E. Chlorophyll
15. Which entry below correctly describes the approximate number of bp of DNA _____, which is separated into _____ chromosomes in atypical diploid human cell in a nonreplicating state?
 - A. 64 billion, 23
 - B. 6.4 trillion, 46
 - C. 23 billion, 64
 - D. 64 billion, 46
 - E. 6.4 billion, 46
16. What is the approximate number of base pairs associated with a single nucleosome?
 - A. 146
 - B. 292
 - C. 73
 - D. 1460
 - E. 900
17. All but one of the following histones are found located within the superhelix formed between DNA and the histone octamer; this histone is
 - A. Histone H2B
 - B. Histone H3
 - C. Histone H1
 - D. Histone H3
 - E. Histone H4
18. Chromatin can be broadly defined as active and repressed; a subclass of chromatin that is specifically inactivated at certain times within an organism's life and/or in particular sets of differentiated cells is termed
 - A. Constitutive euchromatin
 - B. Facultative heterochromatin
 - C. Euchromatin
 - D. Constitutive heterochromatin
19. Which of the following hypothesizes that the physical and functional status of a certain region of genomic chromatin is dependent upon the patterns of specific histone posttranslational modifications (PTMs), and/or DNA methylation status?
 - A. Morse code
 - B. PTM hypothesis
 - C. Nuclear body hypothesis
 - D. Epigenetic code
 - E. Genetic code
20. What is the name of the unusual repeated stretch of DNA localized at the tips of all eukaryotic chromosomes?
 - A. Kinetochores
 - B. Telomere
 - C. Centriole
 - D. Chromomere
 - E. Micromere
21. Given that DNA polymerases are unable to synthesize DNA without a primer, what molecule serves as the primer for these enzymes during DNA replication?
 - A. Five carbon sugars
 - B. Deoxyribose alone
 - C. A short RNA molecule
 - D. Proteins with free hydroxyl groups
 - E. Phosphomonoester
22. The discontinuous DNA replication that occurs during replication is catalyzed via the production of small DNA segments termed
 - A. Okazaki fragments
 - B. Toshihiro pieces
 - C. Onishi oligonucleotides
 - D. Crick strands
 - E. Watson fragments
23. What molecule or force supplies the energy that drives the relief of mechanical strain by DNA gyrase?
 - A. Pyrimidine to purine conversion
 - B. Hydrolysis of GTP
 - C. Hydrolysis of ATP
 - D. Glycolysis
 - E. A proton gradient molecule or force
24. What is the name of the phase of the cell cycle between the conclusion of cell division and the beginning of DNA synthesis?
 - A. G₁
 - B. S
 - C. G₂
 - D. M
 - E. G₀
25. At what stage of the cell cycle are key protein kinases, like cyclin-dependent kinase, activated?
 - A. Right before mitosis
 - B. At the beginning of S phase
 - C. Near the end of G₁ phase
 - D. At the end of the G₂ phase
 - E. All of the above

26. What disease is often associated with a breakdown of a cell's ability to regulate/control its own division?
- Kidney disease
 - Cancer
 - Emphysema
 - Diabetes
 - Heart disease
27. What is the molecular mechanism that is responsible for the quick decrease in the Cdk activity that leads to exit from the M phase and the entry into G_1 ?
- Drop in mitotic cyclin concentration
 - Decreased G_1 cyclin concentration
 - Rise in G_2 cyclin concentration
 - Rise in mitotic cyclin concentration
 - Rise in G_1 cyclin concentration
28. The site to which RNA polymerase binds on the DNA template prior to the initiation of transcription.
- Intron/exon junction
 - Open reading frame DNA
 - Terminator
 - Initiator methionine codon
 - Promoter
29. The large eukaryotic rRNA genes, such as 18S and 28S RNA-encoding genes, are transcribed by which of the following RNA polymerases?
- RNA polymerase III
 - RNA-dependent RNA polymerase δ
 - RNA polymerase I
 - RNA polymerase II
 - Mitochondrial RNA polymerase
30. Eukaryotic RNA polymerases all have a requirement for a large variety of accessory proteins to enable them to bind promoters and form physiologically relevant transcription complexes; these proteins are termed
- Basal or general transcription factors
 - Activators
 - Accessory factors
 - Elongation factors
 - Facilitator polypeptides
31. The DNA segment from which the primary transcript is copied or transcribed is called
- Coding strand
 - Initiator methionine domain
 - Translation unit
 - Transcriptome
 - Initial codon
32. What class of DNA are the eukaryotic rDNA cistrons?
- Single copy DNA
 - Highly repetitive DNA
 - Moderately repetitive DNA
 - Mixed sequence DNA
33. Modifications to the nucleotides of the pre-tRNAs, pre-rRNAs and pre-mRNAs occur
- Postprandially
 - Postmitotically
 - Pretranscriptionally
 - Posttranscriptionally
 - Prematurely
34. RNA polymerase II promoters are located on which side of the transcription unit?
- Internal
 - 3' downstream
 - Nearest the C-terminus
 - Nearest the N-terminus
 - 5' upstream
35. With regard to eukaryotic mRNAs, one of the following is not a normal property of mRNAs.
- Eukaryotic mRNAs have special modifications at their 5' (cap) and 3' (poly(A) tail) termini.
 - Are attached to ribosomes when they are translated.
 - They are found in the cytoplasm within peroxisomes.
 - Most have a significant noncoding segment that does not direct assembly of amino acids.
 - Contain continuous nucleotide sequences that encode a particular polypeptide.
36. The bond connecting the initiation nucleotide of the mRNA with the 5^{me}-G Cap structure is a 3
- 3'-5' phosphodiester bridge
 - 5'-5' triphosphate bridge
 - 3'-3' triphosphate bridge
 - 3'-5' triphosphate bridge
 - 5'-3' triphosphate bridge
37. What sequence feature of mature mRNAs listed below is thought to protect mRNAs from degradation?
- Special posttranslational modifications
 - 3' Poly(C)_n tail
 - 5^{me}-G Cap
 - Introns
 - Lariat structures
38. What could the consequences of inaccurate mRNA splicing be for the RNA?
- A single base error at a splice junction will cause a large deletion.
 - A single base error at a splice junction will cause a large insertion.
 - A single base error at a splice junction will cause a large inversion.
 - C and E.
 - A single base error at a splice junction will change the reading frame and result in mRNA mistranslation.
39. What is the macromolecular complex that associates with introns during mRNA splicing?
- Splicer
 - Dicer
 - Nuclear body
 - Spliceosome
 - Slicer
40. What reaction does reverse transcriptase catalyze?
- Translation of RNA to DNA
 - Transcription of DNA to RNA
 - Conversion of ribonucleotides into deoxyribonucleotides
 - Transcription of RNA to DNA
 - Conversion of a ribonucleotide to deoxynucleotides in the DNA double helix

41. RNAi or dsRNA-mediated RNA interference mediates
- RNA ligation
 - RNA silencing
 - RNA inversion
 - RNA restoration
 - RNA quelling
42. While the genetic code has 64 codons, there are only 20 naturally occurring amino acids. Consequently, some amino acids are encoded by more than one codon. This feature of the genetic code is an illustration of the genetic code being
- Degenerate
 - Duplicative
 - Nonoverlapping
 - Overlapping
 - Redundant
43. The genetic code contains _____ termination codons?
- 3
 - 21
 - 61
 - 64
 - 20
44. If a tRNA has the sequence 5'-CAU-3', what codon would it recognize (ignore wobble base pairing).
- 3'-UAC-5'
 - 3'-AUG-5'
 - 5'-ATG-3'
 - 5'-AUC-3'
 - 5'-AUG-3'
45. What is on the 3' end of all functional, mature tRNAs?
- The cloverleaf loop
 - The anticodon
 - The sequence CCA
 - The codon
46. Most aminoacyl-tRNA synthetases possess an activity that is shared with DNA polymerases. This activity is a _____ function.
- Proofreading
 - Hydrogenase
 - Proteolytic
 - Helicase
 - Endonucleolytic
47. The three distinct phases of protein synthesis, in the CORRECT order are
- Initiation, termination, elongation
 - Termination, initiation, elongation
 - Initiation, elongation, termination
 - Elongation, initiation, termination
 - Elongation, termination, initiation
48. Which amino acid is the initiating amino acid for essentially all proteins?
- Cysteine
 - Threonine
 - Tryptophan
 - Methionine
 - Glutamic acid
49. The initiator tRNA is placed within the active 80S complex at which of the three canonical ribosomal "sites" during protein synthesis
- E site
 - I site
 - P site
 - A site
 - Releasing factor binding site
50. Name the enzyme that forms the peptide bond during protein synthesis and define its chemical composition.
- Pepsynthase, protein
 - Peptidyl transferase, RNA
 - Peptidase, glycolipid
 - Peptidyl transferase, protein
 - GTPase, glycopeptide
51. Mutations in the middle of an open reading frame that create a stop codon are termed
- Frameshift mutation
 - Missense mutation
 - No-nonsense mutation
 - Point mutation
 - Nonsense mutation
52. What is the directionality of polypeptide synthesis?
- C-terminal to N-terminal direction
 - N-terminal to 3' direction
 - N-terminal to C-terminal direction
 - 3' to 5' direction
 - 5' to 3' direction
53. Which of the following cis-acting elements typically resides adjacent to or overlaps with many prokaryotic promoters?
- Regulatory gene
 - Structural gene(s)
 - Repressor
 - Operator
 - Terminator
54. What is the term applied to a segment of a bacterial chromosome where genes for the enzymes of a particular metabolic pathway are clustered and subject to coordinate control?
- Operon
 - Operator
 - Promoter
 - Terminal controller
 - Origin
55. What is the term applied to the complete collection of proteins present in a particular cell type?
- Genome
 - Peptide collection
 - Transcriptome
 - Translatome
 - Proteome
56. How does nucleosome formation on genomic DNA affect the initiation and/or elongation phases of transcription?
- Nucleosomes inhibit access of enzymes involved in all phases of transcription.
 - Nucleosomes recruit histone and DNA modifying enzymes, and the actions of these recruited enzymes affect the access of transcription proteins to DNA.

- C. Nucleosomes induce DNA degradation where the DNA contacts the histones.
 D. Nucleosomes have no significant effect on transcription.
57. Which types of molecules interact with eukaryotic mRNA gene core promoter sites to facilitate the association of RNA polymerase II?
 A. Termination factors
 B. Sequence-specific transcription factors (transactivators)
 C. Elongation factors
 D. GTPases
 E. General, or basal transcription factors (ie, the GTFs)
58. Most eukaryotic transcription factors contain at least two domains, each of which mediate different aspects of transcription factor function; these domains are
 A. RNA-binding domain and repression domain
 B. Activation domain and repression domain
 C. DNA-binding domain and activation domain
 D. DNA-binding domain and ligand binding domain
 E. RNA-binding domain and the activation domain
59. Transcription factors bound at enhancers stimulate the initiation of transcription at the cis-linked core promoter through the action of intermediaries termed
 A. Coactivators
 B. Cotranscription proteins
 C. Corepressors
 D. Receptors
 E. Coordinators
60. What reactions among transcription proteins greatly expand the diversity of regulatory factors that can be generated from a small number of polypeptides?
 A. Recombination
 B. Homodimerization
 C. Heterozygosity
 D. Heterodimerization
 E. Trimerization
61. The gene region containing the TATA box and extending to the transcription start site (TSS) is often termed the _____.
 A. Polymerase home
 B. Initiator
 C. Start selector
 D. Core promoter
 E. Operator
62. Which of the following possible mechanisms for how enhancers can stimulate transcription from great distances are currently thought to be CORRECT?
 A. Enhancers can reversibly excise the intervening DNA between enhancers and promoters.
 B. RNA polymerase II binds avidly to enhancer sequences.
 C. Enhancers unwind DNA.
 D. Enhancers can search through DNA and bind directly to the associated core promoter.
 E. Enhancers and core promoters are brought into close proximity through DNA loop formation mediated by DNA binding proteins.
63. Which of the following histone amino acids are typically acetylated?
 A. Lysine
 B. Arginine
 C. Asparagine
 D. Histidine
 E. Leucine
64. Place the following steps in order; what are the steps that occur sequentially during a transcription activation event following the binding of a transcriptional activator to its cognate activator binding site on genomic DNA.
 1. The chromatin remodeling complex binds to the core histones at the target region.
 2. The combined actions of the various molecular complexes increase promoter accessibility to the transcriptional machinery.
 3. The activator recruits a coactivator to a region of chromatin targeted for transcription.
 4. Transcriptional machinery assembles at the site where transcription will be initiated.
 5. The coactivator acetylates the core histones of nearby nucleosomes.
 A. 1 – 2 – 3 – 4 – 5
 B. 3 – 1 – 5 – 2 – 4
 C. 3 – 5 – 1 – 2 – 4
 D. 5 – 3 – 1 – 2 – 4
 E. 3 – 5 – 1 – 4 – 2
65. What strategy in transcription factor research allows for the simultaneous identification of all of the genomic sites bound by a given transcription factor under a given set of physiological conditions?
 A. Systematic deletion mapping
 B. DNase I sensitivity
 C. Chromatin immunoprecipitation-sequencing (ChIP-seq)
 D. FISH
 E. Fluorescence lifetime imaging microscopy
66. Which sequences extend between the 5' methylguanosine cap present on eukaryotic mRNAs to the AUG initiation codon?
 A. Stop codon
 B. Last exon
 C. Last intron
 D. 3' UTR
 E. 5' UTR
67. Which of the following features of eukaryotic mRNA contribute importantly to message half-life?
 A. 5' UTR sequences
 B. The promoter
 C. The operator
 D. 3' UTR and poly(A) tail
 E. The first intron

This page intentionally left blank

Membranes: Structure & Function

Robert K. Murray, MD, PhD & P. Anthony Weil, PhD

OBJECTIVES

After studying this chapter, you should be able to:

- Know that biological membranes are mainly composed of a lipid bilayer and associated proteins and glycoproteins. The major lipids are phospholipids, cholesterol, and glycosphingolipids.
- Appreciate that membranes are asymmetric, dynamic structures containing a mixture of integral and peripheral proteins.
- Know the fluid mosaic model of membrane structure and that it is widely accepted, with lipid rafts, caveolae, and tight junctions being specialized features.
- Understand the concepts of passive diffusion, facilitated diffusion, active transport, endocytosis, and exocytosis.
- Recognize that transporters, ion channels, the Na⁺ – K⁺-ATPase, receptors, and gap junctions are important participants in membrane function.
- Know that a variety of disorders result from abnormalities of membrane structure and function, including familial hypercholesterolemia, cystic fibrosis, hereditary spherocytosis, and many others.

BIOMEDICAL IMPORTANCE

Membranes are highly fluid, dynamic structures consisting of a lipid bilayer and associated proteins. **Plasma membranes** form closed compartments around the cytoplasm to define cell boundaries. The plasma membrane has **selective permeabilities** and acts as a barrier, thereby maintaining differences in composition between the inside and outside of the cell. Selective membrane molecular permeability is generated through the action of specific **transporters** and **ion channels**. The plasma membrane also exchanges material with the extracellular environment by **exocytosis** and **endocytosis**, and there are special areas of membrane structure—**gap junctions**—through which adjacent cells may exchange material. In addition, the plasma membrane plays key roles in **cell-cell interactions** and in **transmembrane signaling**.

Membranes also form **specialized compartments** within the cell. Such intracellular membranes help **shape** many of the morphologically distinguishable structures (organelles), for example, mitochondria, ER, Golgi, secretory granules, lysosomes, and the nucleus. Membranes localize **enzymes**, function as integral elements in **excitation-response coupling**, and provide sites of **energy transduction**, such as in photosynthesis (chloroplasts) and oxidative phosphorylation (mitochondria).

Changes in membrane components can affect water balance and ion flux, and therefore many processes within the cell. Specific deficiencies or alterations of certain membrane components (eg, caused by mutations in genes encoding membrane proteins) lead to a variety of **diseases** (see Table 40–7). In short, normal cellular function depends on normal membranes.

MAINTENANCE OF A NORMAL INTRA- & EXTRACELLULAR ENVIRONMENT IS FUNDAMENTAL TO LIFE

Life originated in an aqueous environment; enzyme reactions, cellular and subcellular processes have therefore evolved to work in this milieu, encapsulated within a cell.

The Body's Internal Water Is Compartmentalized

Water makes up about 60% of the lean body mass of the human body and is distributed in two large compartments.

Intracellular Fluid (ICF)

This compartment constitutes **two-thirds** of total body water and provides a specialized environment for the cell (1) to make, store, and utilize energy; (2) to repair itself; (3) to replicate; and (4) to perform cell-specific functions.

Extracellular Fluid (ECF)

This compartment contains about **one-third** of total body water and is distributed between the plasma and interstitial compartments. The extracellular fluid is a **delivery system**. It brings to the cells nutrients (eg, glucose, fatty acids, and amino acids), oxygen, various ions and trace minerals, and a variety of regulatory molecules (hormones) that coordinate the functions of widely separated cells. Extracellular fluid **removes** CO₂, waste products, and toxic or detoxified materials from the immediate cellular environment.

The Ionic Compositions of Intracellular & Extracellular Fluids Differ Greatly

As illustrated in Table 40–1, the **internal environment** is rich in K⁺ and Mg²⁺, and phosphate is its major inorganic anion.

TABLE 40–1 Comparison of the Mean Concentrations of Various Molecules Outside and Inside a Mammalian Cell

Substance	Extracellular Fluid	Intracellular Fluid
Na ⁺	140 mmol/L	10 mmol/L
K ⁺	4 mmol/L	140 mmol/L
Ca ²⁺ (free)	2.5 mmol/L	0.1 μmol/L
Mg ²⁺	1.5 mmol/L	30 mmol/L
Cl ⁻	100 mmol/L	4 mmol/L
HCO ₃ ⁻	27 mmol/L	10 mmol/L
PO ₄ ³⁻	2 mmol/L	60 mmol/L
Glucose	5.5 mmol/L	0–1 mmol/L
Protein	2 g/dL	16 g/dL

The cytosol of cells contains a high concentration of protein that acts as a major intracellular buffer. **Extracellular fluid** is characterized by high Na⁺ and Ca²⁺ content, and Cl⁻ is the major anion. These ionic differences are maintained due to various membranes found in cells. These membranes have unique lipid and protein compositions. A fraction of the protein constituents of membrane proteins are specialized to generate and maintain the differential ionic compositions of the extra- and intracellular compartments.

MEMBRANES ARE COMPLEX STRUCTURES COMPOSED OF LIPIDS, PROTEINS, & CARBOHYDRATE-CONTAINING MOLECULES

We shall mainly discuss the membranes present in eukaryotic cells, although many of the principles described also apply to the membranes of prokaryotes. The various cellular membranes have different lipid (see below) and protein compositions. The ratio of protein to lipid in different membranes is presented in Figure 40–1, and is responsible for the many

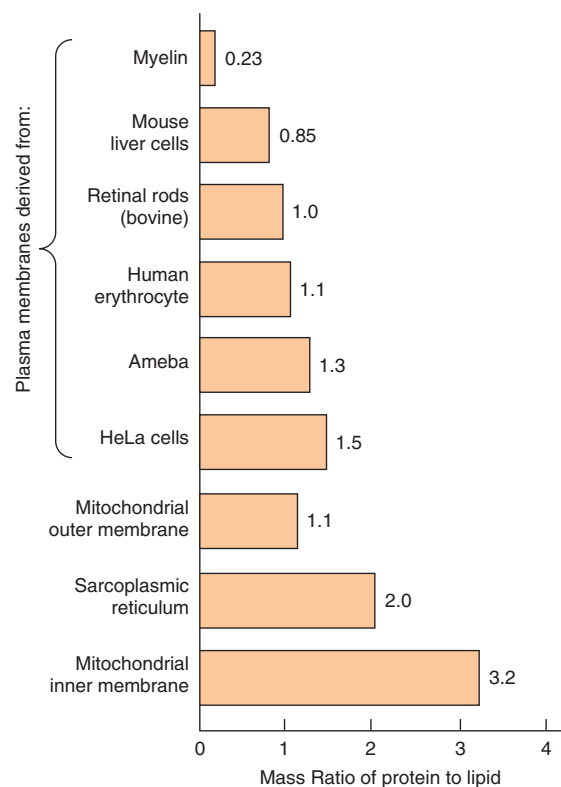

FIGURE 40–1 Membrane protein content is highly variable.

The amount of proteins equals or exceeds the quantity of lipid in nearly all membranes. The outstanding exception is myelin, an electrical insulator found on many nerve fibers.

divergent functions of cellular organelles. Membranes are sheet-like enclosed structures consisting of an asymmetric lipid bilayer with distinct inner and outer surfaces or leaflets. These structures and surfaces are protein-studded, sheet-like, noncovalent assemblies that form spontaneously in water due to the amphipathic nature of lipids and the proteins contained within the membrane.

The Major Lipids in Mammalian Membranes Are Phospholipids, Glycosphingolipids & Cholesterol

Phospholipids

Of the two major phospholipid classes present in membranes, **phosphoglycerides** are the more common and consist of a glycerol-phosphate backbone to which are attached two fatty acids in ester linkages and an alcohol (Figure 40–2). The **fatty acid** constituents are usually even-numbered carbon molecules, most commonly containing 16 or 18 carbons. They are unbranched and can be saturated or unsaturated with one or more double bonds. The simplest phosphoglyceride is **phosphatidic acid**, a 1,2-diacylglycerol 3-phosphate, a key intermediate in the formation of other phosphoglycerides (see Chapter 24). In most phosphoglycerides present in membranes, the 3-phosphate is esterified to an **alcohol** such as choline, ethanolamine, glycerol, inositol or serine (see Chapter 21). Phosphatidylcholine is generally the major phosphoglyceride by mass in the membranes of human cells.

The second major class of phospholipids comprises **sphingomyelin** (see Figure 21–13), a phospholipid that contains a sphingosine rather than a glycerol backbone. A fatty acid is attached by an amide linkage to the amino group of sphingosine, forming **ceramide**. When the primary hydroxyl group of sphingosine is esterified to phosphorylcholine, sphingomyelin is formed. As the name suggests, sphingomyelin is prominent in myelin sheaths.

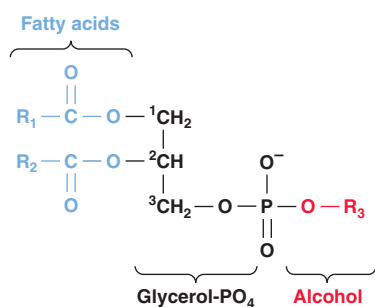

FIGURE 40–2 A phosphoglyceride showing the fatty acids (R_1 and R_2), glycerol, and a phosphorylated alcohol component. Saturated fatty acids are usually attached to carbon 1 of glycerol, and unsaturated fatty acids to carbon 2. In phosphatidic acid, R_3 is hydrogen.

Glycosphingolipids

The glycosphingolipids (GSLs) are sugar-containing lipids built on a backbone of **ceramide**. GSLs include **galactosyl-** and **glucosyl-ceramides** (cerebrosides) and the **gangliosides** (see structures in Chapter 21), and are mainly located in the plasma membranes of cells, displaying their sugar components to the exterior of the cell.

Sterols

The most common sterol in the membranes of animal cells is **cholesterol** (see Chapter 21). The majority of cholesterol resides within **plasma membranes**, but smaller amounts are found within mitochondrial, Golgi complex, and nuclear membranes. Cholesterol intercalates among the phospholipids of the membrane, with its hydrophilic hydroxyl group at the aqueous interface and the remainder of the molecule buried within the lipid bilayer leaflet. From a nutritional viewpoint, it is important to know that cholesterol is not present in plants.

Lipids can be separated from one another and quantified by techniques such as column, thin-layer, and gas-liquid chromatography and their structures established by mass spectrometry and other techniques (see Chapter 4).

Membrane Lipids Are Amphipathic

All major lipids in membranes contain both hydrophobic and hydrophilic regions and are therefore termed **amphipathic**. If the hydrophobic region were separated from the rest of the molecule, it would be insoluble in water but soluble in organic solvents. Conversely, if the hydrophilic region were separated from the rest of the molecule, it would be insoluble in organic solvents but soluble in water. The amphipathic nature of a phospholipid is represented in Figure 40–3 and also Figure 21–24. Thus, the **polar head groups** of the phospholipids and the hydroxyl group of cholesterol interface with the

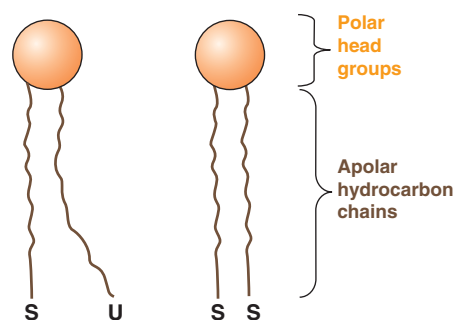

FIGURE 40–3 Diagrammatic representation of a phospholipid or other membrane lipid. The polar head group is hydrophilic, and the hydrocarbon tails are hydrophobic or lipophilic. The fatty acids in the tails are saturated (S) or unsaturated (U); the former are usually attached to carbon 1 of glycerol and the latter to carbon 2 (see Figure 40–2). Note the kink in the tail of the unsaturated fatty acid (U), which is important in conferring increased membrane fluidity.

aqueous environment; a similar situation applies to the **sugar moieties** of the GSLs (see below).

Saturated fatty acids form relatively straight tails, whereas unsaturated fatty acids, which generally exist in the *cis* form in membranes, form “kinked” tails (Figure 40–3; see also Figures 21–1, 21–6). As the number of double bonds within the lipid side chains increase, the number of kinks in the tails increases. As a consequence, the membrane lipids become less tightly packed and the membrane more fluid. The problem caused by the presence of **trans fatty acids** in membrane lipids is described in Chapter 21.

Detergents are amphipathic molecules that are important in biochemistry as well as in the household. The molecular structure of a detergent is not unlike that of a phospholipid. Certain detergents are widely used to **solubilize** and purify membrane proteins. The hydrophobic end of the detergent binds to hydrophobic regions of the proteins, displacing most of their bound lipids. The polar end of the detergent is free, bringing the proteins into solution as detergent-protein complexes, usually also containing some residual lipids.

Membrane Lipids Form Bilayers

The amphipathic character of phospholipids suggests that the two regions of the molecule have incompatible solubilities. However, in a solvent such as water, phospholipids spontaneously organize themselves into **micelles** (Figure 40–4 and Figure 21–24), an assembly that thermodynamically satisfies the solubility requirements of the two chemically distinct regions of these molecules. Within the micelle the hydrophobic regions of the amphipathic phospholipids are shielded from water, while the hydrophilic polar groups are immersed in the aqueous environment. Micelles are usually relatively

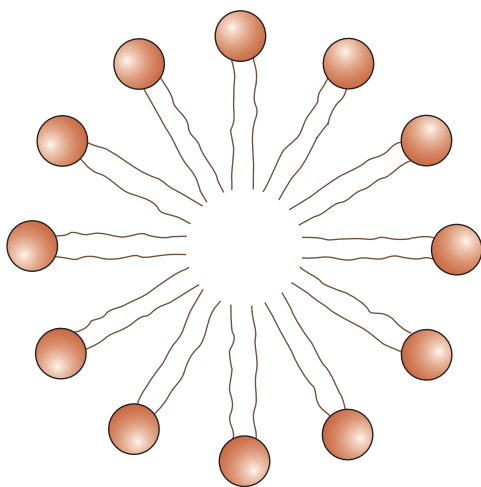

FIGURE 40–4 Diagrammatic cross-section of a micelle. The polar head groups are bathed in water, whereas the hydrophobic hydrocarbon tails are surrounded by other hydrocarbons and thereby protected from water. Micelles are relatively small (compared with lipid bilayers) spherical structures.

small in size (eg, ~200 nm) and consequently are limited in their potential to form membranes. Detergents commonly form micelles.

Phospholipids and similar amphipathic molecules can form another structure, the **bimolecular lipid bilayer**, which also satisfies the thermodynamic requirements of amphipathic molecules in an aqueous environment. Bilayers are the key structures in biological membranes. Bilayers exist as sheets wherein the hydrophobic regions of the phospholipids are sequestered from the aqueous environment, while the hydrophilic, charged portions are exposed to water (Figure 40–5 and Figure 21–24). The ends or edges of the bilayer sheet can be eliminated by folding the sheet back upon itself to form an enclosed vesicle with no edges. The closed bilayer provides one of the most essential properties of membranes. The lipid bilayer is **impermeable to most water-soluble molecules** since such charged molecules would be insoluble in the hydrophobic core of the bilayer. The **self-assembly of lipid bilayers** is driven by the **hydrophobic effect** (see Chapter 2). When lipid molecules come together in a bilayer, the entropy of the surrounding solvent molecules increases due to the release of immobilized water.

Two questions arise from consideration of the information described above. First, how many biologically important molecules are **lipid-soluble** and can therefore readily enter the cell? Gases such as oxygen, CO₂, and nitrogen—small molecules with little interaction with solvents—readily diffuse through the hydrophobic regions of the membrane. The **permeability coefficients** of several ions and a number of other molecules in a lipid bilayer are shown in Figure 40–6. The electrolytes Na⁺, K⁺, and Cl⁻ cross the bilayer much more slowly than water. In general, the permeability coefficients of small molecules in a lipid bilayer **correlate with their solubilities in nonpolar solvents**. For instance, **steroids** more readily traverse the lipid bilayer compared with electrolytes. The high permeability coefficient of **water** itself is surprising, but

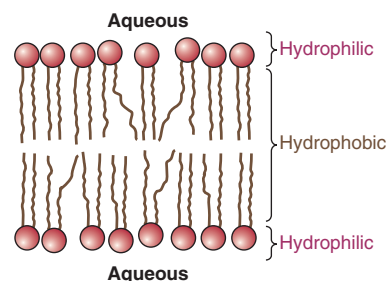

FIGURE 40–5 Diagram of a section of a bilayer membrane formed from phospholipid molecules. The unsaturated fatty acid tails are kinked and lead to more spacing between the polar head groups, hence to more room for movement. This in turn results in increased membrane fluidity. (Slightly modified and reproduced, with permission, from Stryer L: *Biochemistry*, 2nd ed. Freeman, 1981. Copyright ©1981 by W. H. Freeman and Company.)

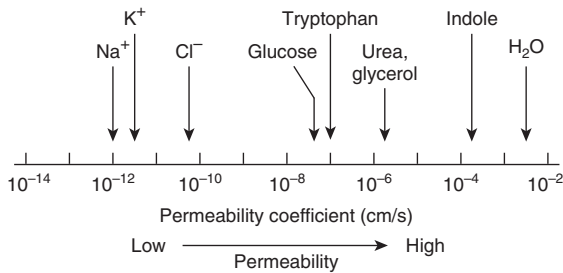

FIGURE 40-6 Permeability coefficients of water, some ions, and other small molecules in lipid bilayer membranes. The permeability coefficient is a measure of the ability of a molecule to diffuse across a permeability barrier. Molecules that move rapidly through a given membrane are said to have a high permeability coefficient. (Slightly modified and reproduced, with permission, from Stryer L: *Biochemistry*, 2nd ed. Freeman, 1981. Copyright © 1981.)

is partly explained by its small size and relative lack of charge. Many **drugs** are hydrophobic and can readily cross membranes and enter cells.

The second question concerns **non-lipid-soluble molecules**. How are the transmembrane concentration gradients for these molecules maintained? The answer is that **membranes contain proteins**, many of which span the lipid bilayer. These proteins either form **channels** for the movement of ions and small molecules or serve as **transporters** for molecules that otherwise could not readily traverse the lipid bilayer (membrane). The nature, properties, and structures of membrane channels and transporters are described below.

Membrane Proteins Are Associated With the Lipid Bilayer

Membrane **phospholipids** act as a solvent for membrane proteins, creating an environment in which the latter can function. As described in Chapter 5, the **α -helical structure of proteins** minimizes the hydrophilic character of the peptide bonds themselves. Thus, proteins can be amphipathic and form an integral part of the membrane by having hydrophilic regions protruding at the inside and outside faces of the membrane but connected by a hydrophobic region traversing the hydrophobic core of the bilayer. In fact, those portions of membrane proteins that traverse membranes do contain substantial numbers of hydrophobic amino acids and almost invariably have a high α -helical content. For most membranes, a stretch of ~20 amino acids in an α -helical configuration will span the lipid bilayer.

It is possible to calculate whether a particular sequence of amino acids present in a protein is consistent with a **trans-membrane location**. This can be done by consulting a table that lists the hydrophobicities of each of the 20 common amino acids and the free energy values for their transfer from the interior of a membrane to water. Hydrophobic amino acids have positive values; polar amino acids have negative values. The total free energy values for transferring successive sequences of 20 amino acids in the protein are plotted, yielding

a so-called **hydropathy plot**. Values of over 20 kcal mol⁻¹ are consistent with—but do not prove—the interpretation that the hydrophobic sequence is a transmembrane segment.

Another aspect of the interaction of lipids and proteins is that some proteins are anchored to one leaflet of the bilayer by covalent linkages to certain lipids; this process is termed **protein lipidation**. Lipidation can occur at protein termini (N- or C-) or internally. Common protein lipidation events are: C-terminal protein **isoprenylation**, **cholesterylation** and **glycophosphatidylinositol (GPI)** (see Chapter 46); N-terminal protein **myristoylation** and internal cysteine **S-prenylation** and **S-acylation**. Such lipidation only occurs on a specific subset of proteins.

Different Membranes Have Different Protein Compositions

The **number of different proteins** in a membrane varies from less than a dozen very abundant proteins in the sarcoplasmic reticulum of muscle cells to hundreds in plasma membranes. Proteins are the **major functional molecules** of membranes and consist of **enzymes**, **pumps** and **transporters**, **channels**, **structural components**, **antigens** (eg, for histocompatibility), and **receptors** for various molecules. Because every type of membrane possesses a different complement of proteins, there is no such thing as a typical membrane structure. The enzymes associated with several different membranes are shown in **Table 40-2**.

Membranes Are Dynamic Structures

Membranes and their components are dynamic structures. Membrane lipids and proteins undergo turnover, just as they do in other compartments of the cell. Different lipids have different turnover rates, and the turnover rates of individual species of membrane proteins may vary widely. In some instances the membrane itself can turn over even more rapidly than any

TABLE 40-2 Enzymatic Markers of Different Membranes^a

Membrane	Enzyme	
Plasma	5'-Nucleotidase	
	Adenylyl cyclase	
	Na ⁺ -K ⁺ -ATPase	
Endoplasmic reticulum	Glucose-6-phosphatase	
Golgi apparatus	<i>Cis</i>	GlcNAc transferase I
	<i>Medial</i>	Golgi mannosidase II
	<i>Trans</i>	Galactosyl transferase
	<i>Trans Golgi Network</i>	Sialyl transferase
Inner mitochondrial membrane	ATP synthase	

^aMembranes contain many proteins, some of which have enzymatic activity. Some of these enzymes are located only in certain membranes and can therefore be used as markers to follow the purification of these membranes.

of its constituents. This is discussed in more detail in the section on endocytosis.

Another indicator of the dynamic nature of membranes is that a variety of studies have shown that lipids and certain proteins exhibit **lateral diffusion** in the plane of their membranes. Many nonmobile proteins do not exhibit lateral diffusion because they are anchored to the underlying actin cytoskeleton. By contrast, the **transverse** movement of lipids across the membrane (**flip–flop**) is extremely slow (see below) and does not appear to occur at an appreciable rate in the case of membrane proteins.

Membranes Are Asymmetric Structures

Proteins have unique orientations in membranes, making the **outside surfaces different from the inside surfaces**. An **inside-outside asymmetry** is also provided by the external location of the carbohydrates attached to membrane proteins. In addition, specific proteins are located exclusively on the outsides or insides of membranes.

There are also **regional heterogeneities** in membranes. Some, such as occur at the villous borders of mucosal cells, are almost macroscopically visible. Others, such as those at gap junctions, tight junctions, and synapses, occupy much smaller regions of the membrane and generate correspondingly smaller local asymmetries.

There is also inside-outside **asymmetry of the phospholipids**. The **choline-containing phospholipids** (phosphatidylcholine and sphingomyelin) are located mainly in the **outer leaflet**; the **aminophospholipids** (phosphatidylserine and phosphatidylethanolamine) are preferentially located in the **inner leaflet**. Obviously, if this asymmetry is to exist at all, there must be limited transverse mobility (flip-flop) of the membrane phospholipids. In fact, phospholipids in synthetic bilayers exhibit an **extraordinarily slow rate of flip-flop**; the half-life of the asymmetry in these synthetic bilayers is on the order of several weeks.

The mechanisms involved in the **establishment of lipid asymmetry** are not well understood. The enzymes involved in the synthesis of phospholipids are located on the cytoplasmic side of microsomal membrane vesicles. Translocases (**flippases**) exist that transfer certain phospholipids (eg, phosphatidylcholine) from the inner to the outer leaflet. Specific **proteins that preferentially bind** individual phospholipids also appear to be present in the two leaflets; thus lipid binding also contributes to the asymmetric distribution of specific lipid molecules. In addition, **phospholipid exchange proteins** recognize certain phospholipids and transfer them from one membrane (eg, the endoplasmic reticulum [ER]) to others (eg, mitochondrial and peroxisomal). A related issue is **how lipids enter membranes**. This has not been studied as intensively as the topic of how proteins enter membranes (see Chapter 49) and knowledge is still relatively meager. Many membrane lipids are synthesized in the ER. At least three pathways have been recognized: (1) transport from the ER in vesicles, which then transfer the contained lipids to the recipient membrane; (2) entry via direct contact of one membrane (eg, the ER) with

another, facilitated by specific proteins; and (3) transport via the phospholipid exchange proteins (also known as lipid transfer proteins) mentioned above, which only exchanges lipids, but does not cause net transfer.

There is **further asymmetry** with regard to glycosphingolipids and **glycoproteins**; the **sugar moieties** of these molecules all **protrude outward** from the plasma membrane and are absent from its inner face.

Membranes Contain Integral & Peripheral Proteins

It is useful to classify membrane proteins into two types: **integral** and **peripheral** (Figure 40–7). Most membrane proteins fall into the **integral class**, meaning that they interact extensively with the phospholipids and **require the use of detergents** for their solubilization. Also, they generally span the bilayer as a bundle of α -helical transmembrane segments. Integral proteins are usually globular and are themselves amphipathic. They consist of two hydrophilic ends separated by an intervening hydrophobic region that traverses the hydrophobic core of the bilayer. As the structures of integral membrane proteins were being elucidated, it became apparent that certain ones (eg, transporter molecules, ion channels, various receptors, and G proteins) span the bilayer many times, whereas other simple membrane proteins (eg, glycophorin A) span the membrane only once (see Figures 42–4 and 52–5). Integral proteins are asymmetrically distributed across the membrane bilayer. This asymmetric orientation is conferred at the time of their insertion in the lipid bilayer during biosynthesis in the ER. The molecular mechanisms involved in insertion of proteins into membranes and the topic of membrane assembly are discussed in Chapter 49.

Peripheral proteins do not interact directly with the hydrophobic cores of the phospholipids in the bilayer and thus **do not require use of detergents** for their release. They are bound to the hydrophilic regions of specific integral proteins and head groups of phospholipids and can be released from them by treatment with salt solutions of high ionic strength. For example, ankyrin, a peripheral protein, is bound to the inner aspect of the integral protein “band 3” of the erythrocyte membrane. Spectrin, a cytoskeletal structure within the erythrocyte, is in turn bound to ankyrin and thereby plays an important role in maintenance of the biconcave shape of the erythrocyte.

ARTIFICIAL MEMBRANES MODEL MEMBRANE FUNCTION

Artificial membrane systems can be prepared by appropriate techniques. These systems generally consist of mixtures of one or more phospholipids of natural or synthetic origin that have been treated by using **mild sonication** to induce the formation of spherical vesicles in which the lipids form a bilayer. Such vesicles, surrounded by a lipid bilayer with an aqueous interior, are termed **liposomes** (see Figure 21–24).

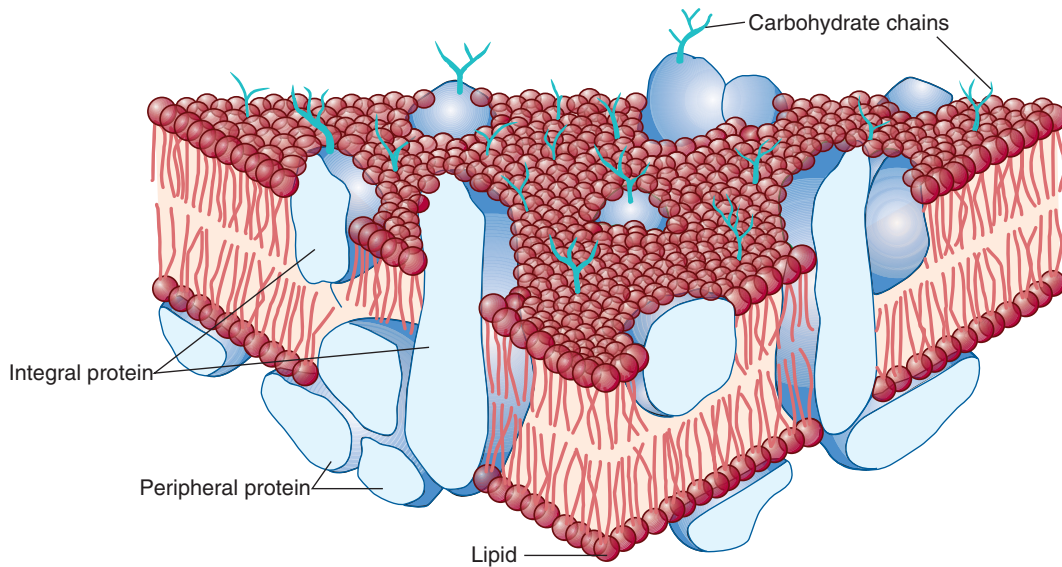

FIGURE 40-7 The fluid mosaic model of membrane structure. The membrane consists of a bimolecular lipid layer with proteins inserted in it or bound to either surface. Integral membrane proteins are firmly embedded in the lipid layers. Some of these proteins completely span the bilayer and are called transmembrane proteins, while others are embedded in either the outer or inner leaflet of the lipid bilayer. Loosely bound to the outer or inner surface of the membrane are the peripheral proteins. Many of the proteins and all the glycolipids have externally exposed oligosaccharide carbohydrate chains. (Reproduced, with permission, from Junqueira LC, Carneiro J: *Basic Histology: Text & Atlas*, 10th ed., McGraw-Hill, 2003.)

The advantages and uses of artificial membrane systems for the biochemical study of membrane function are:

1. The **lipid content** of the membranes can be varied, allowing systematic examination of the effects of varying lipid composition on certain functions.
2. **Purified membrane proteins or enzymes** can be incorporated into these vesicles in order to assess what factors (eg, specific lipids or ancillary proteins) the proteins require to reconstitute their function.
3. The **environment** of these systems can be rigidly controlled and systematically varied (eg, ion concentrations and ligands).
4. When liposomes are formed, they can be made to **entrap** certain compounds within the vesicle such as drugs and isolated genes. There is interest in using liposomes to distribute drugs to certain tissues, and if components (eg, antibodies to certain cell surface molecules) could be incorporated into liposomes so that they would be targeted to specific tissues or tumors, the therapeutic impact would be considerable. **DNA** entrapped inside liposomes appears to be less sensitive to attack by nucleases; this approach may prove useful in attempts at **gene therapy**.

THE FLUID MOSAIC MODEL OF MEMBRANE STRUCTURE IS WIDELY ACCEPTED

The **fluid mosaic model** of membrane structure proposed in 1972 by Singer and Nicolson (**Figure 40-7**) is now widely accepted. The model is often likened to integral membrane

protein “icebergs” floating in a sea of (predominantly) fluid phospholipid molecules. Early evidence for the model was the finding that well characterized, fluorescently labeled integral membrane proteins could be seen microscopically to rapidly and randomly redistribute within the plasma membrane of a hybrid cell formed by the artificial fusion of two different (mouse and human) parent cells (one labeled the other not). It has subsequently been demonstrated that **phospholipids** undergo even more rapid lateral diffusion with subsequent redistribution within the plane of the membrane. Measurements indicate that within the plane of the membrane, one molecule of phospholipid can move several micrometers per second.

The **phase changes**—and thus the **fluidity** of membranes—are largely dependent upon the lipid composition of the membrane. In a lipid bilayer, the hydrophobic chains of the fatty acids can be highly aligned or ordered to provide a rather stiff structure. As the temperature increases, the hydrophobic side chains undergo a **transition** from the **ordered state** (more gel-like or crystalline phase) to a **disordered** one, taking on a more liquid-like or fluid arrangement. The temperature at which membrane structure undergoes the transition from ordered to disordered (ie, melts) is called the “**transition temperature**” (T_m). Longer and more saturated fatty acid chains interact more strongly with each other via their extended hydrocarbon chains and thus cause higher values of T_m —that is, higher temperatures are required to increase the fluidity of the bilayer. On the other hand, **unsaturated bonds** that exist in the **cis configuration** tend to increase the fluidity of a bilayer by decreasing the compactness of the side chain packing without diminishing hydrophobicity (Figures 40-3 and 40-5).

The phospholipids of cellular membranes generally contain at least one unsaturated fatty acid with at least one *cis* double bond.

Cholesterol acts as a buffer to modify the fluidity of membranes. At temperatures below the T_m , it interferes with the interaction of the hydrocarbon tails of fatty acids and thus increases fluidity. At temperatures above the T_m , it limits disorder because it is more rigid than the hydrocarbon tails of the fatty acids and cannot move in the membrane to the same extent, thus limiting fluidity. At high cholesterol-phospholipid ratios, transition temperatures are altogether indistinguishable.

The fluidity of a membrane significantly affects its functions. As membrane fluidity increases, so does its permeability to water and other small hydrophilic molecules. The lateral mobility of integral proteins increases as the fluidity of the membrane increases. If the active site of an integral protein involved in a given function is exclusively in its hydrophilic regions, changing lipid fluidity will probably have little effect on the activity of the protein; however, if the protein is involved in a transport function in which transport components span the membrane, lipid-phase effects may significantly alter the transport rate. The insulin receptor (see Figure 42–8) is an excellent example of altered function with changes in fluidity. As the concentration of unsaturated fatty acids in the membrane is increased (by growing cultured cells in a medium rich in such molecules), fluidity increases. Increased fluidity alters the receptor such that it binds more insulin. At normal body temperature (37°C), the lipid bilayer is in a fluid state. Underscoring the importance of membrane fluidity, it has been shown that bacteria can modify the composition of their membrane lipids to adapt to changes in temperature.

Lipid Rafts, Caveolae, & Tight Junctions Are Specialized Features of Plasma Membranes

Plasma membranes contain **certain specialized structures** whose biochemical natures have been investigated in some detail.

Lipid rafts are specialized areas of the exoplasmic (outer) leaflet of the lipid bilayer enriched in cholesterol, sphingolipids, and certain proteins (Figure 40–8). They have been hypothesized to be involved in **signal transduction** and **other processes**. It is thought that clustering certain components of signaling systems closely together may increase the efficiency of their function.

Caveolae may derive from lipid rafts. Many, if not all, contain the protein **caveolin-1**, which may be involved in their formation from rafts. Caveolae are observable by electron microscopy as flask-shaped indentations of the cell membrane into the cytosol (Figure 40–9). Proteins detected in caveolae include various components of the signal transduction system (eg, the insulin receptor and some G proteins), the folate receptor, and endothelial nitric oxide synthase (eNOS). Caveolae and lipid rafts are active areas of research, and ideas concerning them and their possible roles in various biological processes are rapidly evolving.

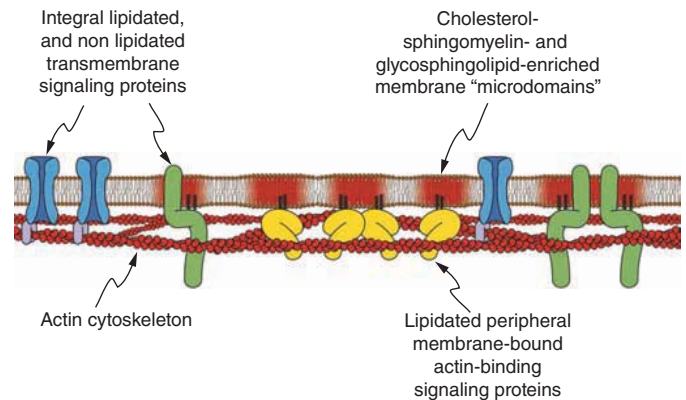

FIGURE 40–8 Schematic diagram of a lipid raft. Shown in schematic form are multiple lipid rafts (red membrane shading) that represent localized microdomains rich in the indicated lipids and signaling proteins (blue, green, yellow). Lipid rafts are stabilized through interactions (direct and indirect) with the actin cytoskeleton (red helical chains; see Figure 51–3). (Figure modified from: The lipid raft hypothesis revisited—new insights on raft composition and function from super-resolution fluorescence microscopy. *Bioessays* 2012;34:739–747. Wiley Periodical, Inc. Copyright © 2012.)

Tight junctions are other structures found in surface membranes. They are often located below the apical surfaces of epithelial cells and **prevent the diffusion of macromolecules between cells**. They are composed of various proteins, including occludin, various claudins, and junctional adhesion molecules.

Yet **other specialized structures** found in surface membranes include **desmosomes**, **adherens junctions**, and **microvilli**; their chemical natures and functions are not discussed here. The nature of **gap junctions** is described below.

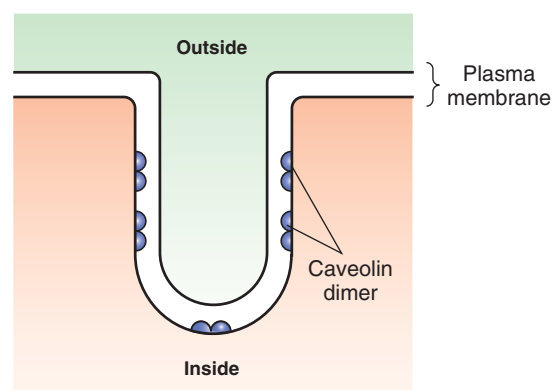

FIGURE 40–9 Schematic diagram of a caveola. A caveola is an invagination in the plasma membrane. The protein caveolin appears to play an important role in the formation of caveolae and occurs as a dimer. Each caveolin monomer is anchored to the inner leaflet of the plasma membrane by three palmitoyl molecules (not shown).

MEMBRANE SELECTIVITY ALLOWS ADJUSTMENTS OF CELL COMPOSITION & FUNCTION

If the plasma membrane is relatively impermeable, how do most molecules enter a cell? How is selectivity of this movement established? Answers to such questions are important in understanding how cells adjust to a constantly changing extracellular environment. Metazoan organisms also must have means of communicating between adjacent and distant cells, so that complex biologic processes can be coordinated. These signals must arrive at and be transmitted by the membrane, or they must be generated as a consequence of some interaction with the membrane. Some of the major mechanisms used to accomplish these different objectives are listed in **Table 40–3**.

Passive Diffusion Involving Transporters & Ion Channels Moves Many Small Molecules Across Membranes

Molecules can **passively** traverse the bilayer down electrochemical gradients by **simple diffusion** or by **facilitated diffusion**. This spontaneous movement toward equilibrium contrasts with **active transport**, which **requires energy** because it constitutes movement against an electrochemical gradient. **Figure 40–10** provides a schematic representation of these mechanisms.

TABLE 40–3 Transfer of Material and Information Across Membranes

Cross-membrane movement of small molecules
Diffusion (passive and facilitated)
Active transport
Cross-membrane movement of large molecules
Endocytosis
Exocytosis
Signal transmission across membranes
Cell surface receptors
1. Signal transduction (eg, glucagon → cAMP)
2. Signal internalization (coupled with endocytosis, eg, the LDL receptor)
Movement to intracellular receptors (steroid hormones; a form of diffusion)
Intercellular contact and communication
Passive (simple) diffusion is the flow of solute from a higher to a lower concentration due to random thermal movement
Facilitated diffusion is passive transport of a solute from a higher concentration to a lower concentration, mediated by a specific protein transporter
Active transport is transport of a solute across a membrane in the direction of increasing concentration, and thus requires energy (frequently derived from the hydrolysis of ATP); a specific transporter (pump) is involved

The other terms used in this table are explained later in this chapter or elsewhere in this text.

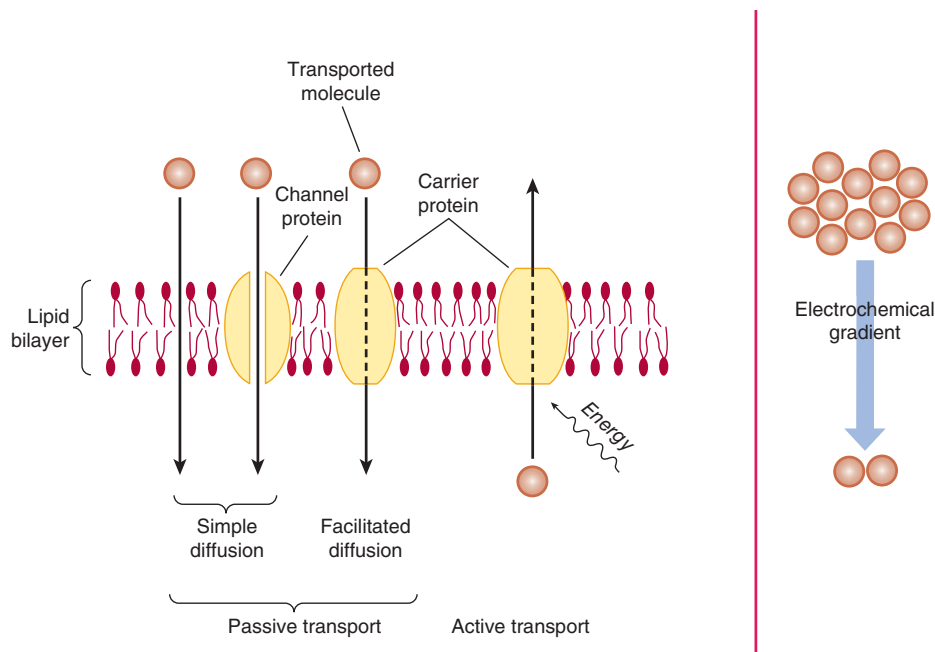

FIGURE 40–10 Many small, uncharged molecules pass freely through the lipid bilayer by simple diffusion. Larger uncharged molecules, and some small uncharged molecules, are transferred by specific carrier proteins (transporters) or through channels or pores. Passive transport is always down an electrochemical gradient (shown schematically, right), toward equilibrium. Active transport is against an electrochemical gradient and requires an input of energy, whereas passive transport does not. (Redrawn and reproduced, with permission, from Alberts B, et al: *Molecular Biology of the Cell*. Garland, 1983.)

Simple diffusion is the passive flow of a solute from a higher to a lower concentration due to random thermal movement. By contrast, **facilitated diffusion** is passive transport of a solute from a higher to a lower concentration mediated by a specific protein transporter. **Active transport** is vectorial movement of a solute across a membrane against a concentration gradient, and thus requires energy (frequently derived from the hydrolysis of ATP); a specific transporter (**pump**) is involved.

As mentioned earlier in this chapter, some solutes such as gases can enter the cell by diffusing down an electrochemical gradient across the membrane and do not require metabolic energy. **Simple diffusion** of a solute across the membrane is limited by three factors: (1) the thermal agitation of that specific molecule; (2) the concentration gradient across the membrane; and (3) the solubility of that solute (the permeability coefficient, Figure 40–6) in the hydrophobic core of the membrane bilayer. Solubility is inversely proportional to the number of hydrogen bonds that must be broken in order for a solute in the external aqueous phase to become incorporated in the hydrophobic bilayer. Electrolytes, poorly soluble in lipid, do not form hydrogen bonds with water, but they do acquire a shell of water from hydration by electrostatic interaction. The size of the shell is directly proportional to the charge density of the electrolyte. Electrolytes with a large charge density have a larger shell of hydration and thus a slower diffusion rate. Na^+ , for example, has a higher charge density than K^+ . Hydrated Na^+ is therefore larger than hydrated K^+ ; hence, the latter tends to move more easily through the membrane.

The following affect **net diffusion** of a substance: (1) concentration gradient across the membrane—solute moves from high to low concentration; (2) electrical potential across the membrane: solutes move toward the solution that has the opposite charge. The inside of the cell usually has a negative charge; (3) permeability coefficient of the substance for the membrane; (4) hydrostatic pressure gradient across the membrane: increased pressure will increase the rate and force of the collision between the molecules and the membrane; and (5) temperature, since increased temperature will increase particle motion and thus increase the frequency of collisions between external particles and the membrane.

Facilitated diffusion involves either certain transporters or ion channels (Figure 40–11). Active transport is mediated

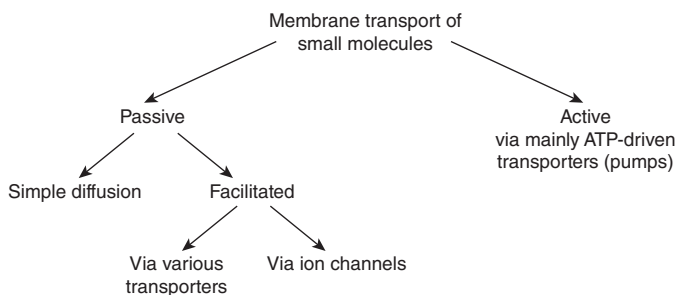

FIGURE 40–11 A schematic diagram of the two types of membrane transport of small molecules.

TABLE 40–4 Comparison of Transporters and Ion Channels

Transporters	Ion Channels
Bind solute and undergo conformational changes, transferring the solute across the membrane	Form pores in membranes
Involved in passive (facilitated diffusion) and active transport	Involved only in passive transport
Transport is significantly slower than via ion channels	Transport is significantly faster than via transporters

Note: Transporters are also known as carriers or permeases. Active transporters are often called pumps.

by other transporters most of which are ATP-driven. A multitude of transporters and channels exist in biological membranes that route the entry of ions into and out of cells. **Table 40–4** summarizes some important differences between transporters and ion channels.

Transporters Are Specific Proteins Involved in Facilitated Diffusion & Also Active Transport

Transport systems can be described in a functional sense according to the number of molecules moved and the direction of movement (Figure 40–12) or according to whether movement is toward or away from equilibrium. The following **classification** depends primarily on the former. A **uniport** system moves one type of molecule bidirectionally. In **cotransport** systems, the transfer of one solute depends upon the stoichiometric simultaneous or sequential transfer of another solute. A **symport** moves two solutes in the same direction. Examples are the proton-sugar transporter in bacteria and the Na^+ -sugar transporters

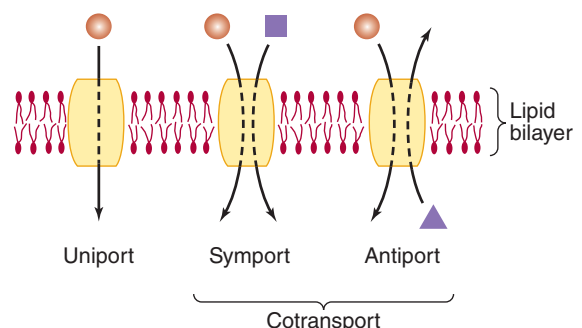

FIGURE 40–12 Schematic representation of types of transport systems. Transporters can be classified with regard to the direction of movement and whether one or more unique molecules are moved. A uniport can also allow movement in the opposite direction, depending on the concentrations inside and outside a cell of the molecule transported. (Redrawn and reproduced, with permission, from Alberts B, et al: *Molecular Biology of the Cell*. Garland, 1983.)

(for glucose and certain other sugars) and Na^+ -amino acid transporters in mammalian cells. **Antiport** systems move two molecules in opposite directions (eg, Na^+ in and Ca^{2+} out).

Hydrophilic molecules that cannot pass freely through the lipid bilayer membrane do so passively by **facilitated diffusion** or by **active transport**. Passive transport is driven by the transmembrane gradient of substrate. Active transport always occurs against an electrical or chemical gradient, and so it requires energy, usually ATP. Both types of transport involve **specific carrier proteins** (transporters) and both show **specificity** for ions, sugars, and amino acids. Passive and active transports **resemble a substrate–enzyme interaction**. Points of resemblance of both to enzyme action are as follows: (1) There is a specific binding site for the solute. (2) The carrier is saturable, so it has a maximum rate of transport (V_{\max} ; **Figure 40–13**). (3) There is a binding constant (K_m) for the solute, and so the whole system has a K_m (**Figure 40–13**). (4) Structurally similar competitive inhibitors block transport. Transporters are thus like enzymes, but generally do not modify their substrates.

Cotransporters use the gradient of one substrate created by active transport to drive the movement of the other substrate. The Na^+ gradient produced by the Na^+ - K^+ -ATPase is used to drive the transport of a number of important metabolites. The ATPase is a very important example of **primary transport**, while the Na^+ -dependent systems are examples of **secondary transport** that rely on the gradient produced by another system. Thus, inhibition of the Na^+ - K^+ -ATPase in cells also blocks the Na^+ -dependent uptake of substances like glucose.

Facilitated Diffusion Is Mediated by a Variety of Specific Transporters

Some specific solutes diffuse down electrochemical gradients across membranes more rapidly than might be expected from their size, charge, or partition coefficient. This is because

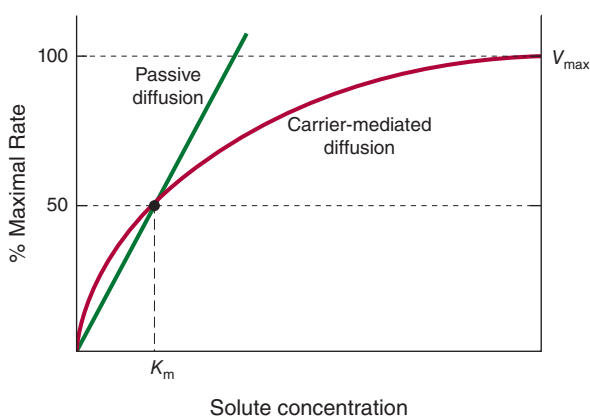

FIGURE 40–13 A comparison of the kinetics of carrier-mediated (facilitated) diffusion with passive diffusion. The rate of movement in the latter is directly proportionate to solute concentration, whereas the process is saturable when carriers are involved. The concentration at half-maximal velocity is equal to the binding constant (K_m) of the carrier for the solute. (V_{\max} , maximal rate.)

specific transporters are involved. This **facilitated diffusion** exhibits properties distinct from those of simple diffusion. The rate of facilitated diffusion, a uniport system, can be saturated; ie, the number of sites involved in diffusion of the specific solutes appears finite. Many facilitated diffusion systems are stereospecific but, like simple diffusion, are driven by the transmembrane electrochemical gradient.

A “**ping-pong**” mechanism (**Figure 40–14**) helps explain facilitated diffusion. In this model, the carrier protein exists in two principal conformations. In the “**ping**” state, it is exposed to high concentrations of solute, and molecules of the solute bind to specific sites on the carrier protein. Binding induces a conformational change that exposes the carrier to a lower concentration of solute (“**pong**” state). This process is completely reversible, and net flux across the membrane depends upon the concentration gradient. The rate at which solutes enter a cell by facilitated diffusion is determined by: (1) the concentration gradient across the membrane; (2) the amount of carrier available (this is a key control step); (3) the affinity of the solute-carrier interaction; (4) the rapidity of the conformational change for both the loaded and the unloaded carrier.

Hormones can regulate facilitated diffusion by changing the number of transporters available. Insulin via a complex signaling pathway increases glucose transport in fat and muscle by recruiting glucose transporters (GLUT) from an intracellular reservoir. Insulin also enhances amino acid transport in liver and other tissues. One of the coordinated actions of glucocorticoid hormones is to enhance transport of amino acids into liver, where the amino acids then serve as a substrate for gluconeogenesis. Growth hormone increases amino acid transport in all cells, and estrogens do this in the uterus. There are at least five different carrier systems for amino acids in animal cells. Each is specific for a group of closely related amino acids, and most operate as Na^+ -symport systems (**Figure 40–12**).

Ion Channels Are Transmembrane Proteins That Allow the Selective Entry of Various Ions

Natural membranes contain transmembrane channels, pore-like structures composed of proteins that constitute selective **ion channels**. Cation-conductive channels have an average diameter of about 5 to 8 nm. The **permeability** of a channel depends upon the size, the extent of hydration, and the extent of charge density on the ion. Specific channels for Na^+ , K^+ , Ca^{2+} , and Cl^- have been identified. The functional α -subunit of a Na^+ channel is schematically illustrated in **Figure 40–15**. The α -subunit is composed of four domains (I–IV) each of which is formed by six contiguous transmembrane α -helices; each of these domains is connected by variable-length intra- and extracellular loops. The amino- and carboxy termini of the α -subunit are located in the cytoplasm. The actual pore in the channel through which Na^+ ions pass is formed by interactions between the four domains, generating a tertiary structure by interactions between the four sets of 5,6 α -helices of domains

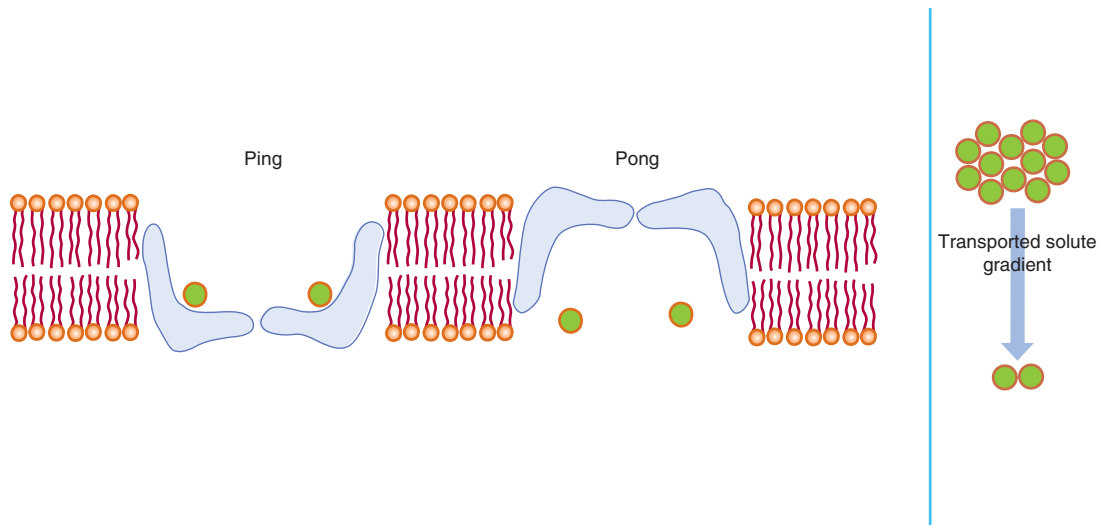

FIGURE 40-14 The “ping-pong” model of facilitated diffusion. A protein carrier (blue structure) in the lipid bilayer associates with a solute in high concentration on one side of the membrane. A conformational change ensues (“ping” to “pong”), and the solute is discharged on the side favoring the new equilibrium (solute concentration gradient shown schematically, right). The empty carrier then reverts to the original conformation (“pong” to “ping”) to complete the cycle.

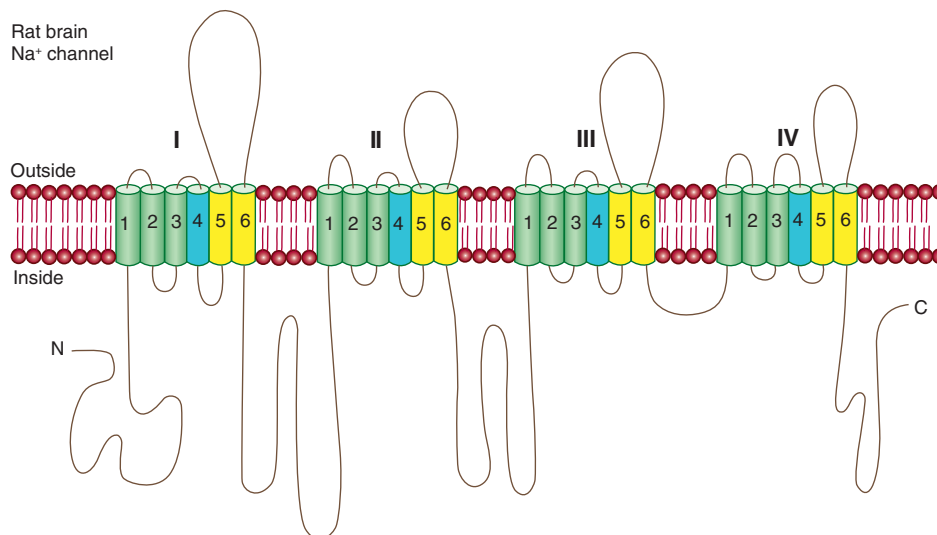

FIGURE 40-15 Diagrammatic representation of the structures of an ion channel (a Na^+ channel of rat brain). The Roman numerals indicate the four domains (I-IV) of the Na^+ channel α -subunit. The α -helical transmembrane domains of each domain are numbered 1 to 6. The four blue-shaded subunits in the different domains represent the voltage-sensing portion of the α -subunit. The actual pore through which the ions (Na^+) pass is not shown, but is formed by apposition of the 5 and 6 transmembrane α -helices of domains I-IV (colored yellow). The specific areas of the subunits involved in the opening and closing of the channel are also not indicated. (After WK Catterall. Modified and reproduced, with permission, from Hall ZW: *An Introduction to Molecular Neurobiology*. Sinauer, 1992.)

I to IV. Na^+ channels are often **voltage sensitive** or **gated**; the voltage sensor of the channel is formed through the interaction domain I-IV the four α -helices-4 formed when domains I to IV interact. This ~5 to 8 nm pore constitutes the center of the tertiary channel structure.

Ion channels are very **selective**, in most cases permitting the passage of only one type of ion (Na^+ , Ca^{2+} , etc). The **selectivity filter** of K^+ channels is made up of a ring of

carbonyl groups donated by the subunits. The carbonyls displace bound water from the ion, and thus restrict its size to appropriate precise dimensions for passage through the channel. Many variations on the structural theme described above for the Na^+ channel have been described. However, all ion channels are basically made up of transmembrane subunits that come together to form a central pore through which ions pass selectively.

TABLE 40-5 Some Properties of Ion Channels

- They are composed of transmembrane protein subunits.
- Most are highly selective for one ion; a few are nonselective.
- They allow impermeable ions to cross membranes at rates approaching diffusion limits.
- They can permit ion fluxes of 10^6 - 10^7 /s.
- Their activities are regulated.
- The main types are voltage-gated, ligand-gated, and mechanically gated.
- They are usually highly conserved across species.
- Most cells have a variety of Na^+ , K^+ , Ca^{2+} , and Cl^- channels.
- Mutations in genes encoding them can cause specific diseases.^a
- Their activities are affected by certain drugs.

^aSome diseases caused by mutations of ion channels are briefly discussed in Chapter 49.

The membranes of nerve cells contain well-studied ion channels that are responsible for the generation of action potentials. The activity of some of these channels is controlled by neurotransmitters; hence, channel activity can be regulated.

Ion channels are open transiently and thus are “gated.” Gates can be controlled by opening or closing. In **ligand-gated channels**, a specific molecule binds to a receptor and opens the channel. **Voltage-gated channels** open (or close) in response to changes in membrane potential. **Mechanically gated channels** respond to mechanical stimuli (pressure and touch). Some properties of ion channels are listed in **Tables 40-4** and **40-5**.

Detailed Studies of a K^+ Channel & of a Voltage-Gated Channel Have Yielded Major Insights Into Their Actions

There are at least four features of ion channels that must be elucidated: (1) their overall structures; (2) how they conduct ions so rapidly; (3) their selectivity; and (4) their gating properties. As described below, considerable progress in tackling these difficult problems has been made.

The **K^+ channel (KvAP)** is an integral membrane protein composed of four identical subunits, each with two transmembrane segments, creating an inverted “V”-like structure (**Figure 40-16**). The part of the channels that confers ion selectivity (the **selectivity filter**) measures 12 Å long (a relatively short length of the membrane, so K^+ does not have far to travel in the membrane) and is situated at the wide end of the inverted “V.” The large, water-filled cavity and helical dipoles shown in **Figure 40-16** help overcome the relatively large electrostatic energy barrier for a cation to cross the membrane. The selectivity filter is lined with carbonyl oxygen atoms (contributed by a TVGYG sequence), providing a number of sites with which K^+ can interact. K^+ ions, which dehydrate as they enter the narrow selectivity filter, fit with proper coordination into the filter, but Na^+ is too small to interact with the carbonyl oxygen atoms in correct alignment and is rejected. Two K^+ ions, when close to each other in the filter, repel one another. This repulsion overcomes interactions between K^+ and the

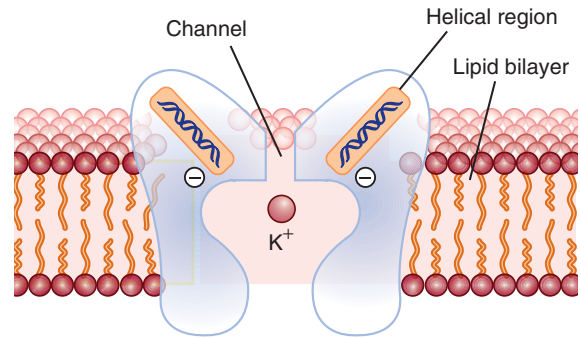

FIGURE 40-16 Schematic diagram of the structure of a K^+ channel (KvAP) from *Streptomyces lividans*. A single K^+ is shown in a large aqueous cavity inside the membrane interior. Two helical regions of the channel protein are oriented with their carboxylate ends pointing to where the K^+ is located. The channel is lined by carbonyl oxygen. (Modified, with permission, from Doyle DA, et al: The structure of the potassium channel: molecular basis of K^+ conduction and selectivity. *Science* 1998;280:69. Reprinted with permission from AAAS.)

surrounding protein molecule and allows very rapid conduction of K^+ with high selectivity.

Other studies on a voltage-gated ion channel (HvAP) in *Aeropyrum pernix* have revealed many features of its voltage-sensing and voltage-gating mechanisms. This channel is made up of four subunits, each with six transmembrane segments. One of the six segments (S4 and part of S3) is the voltage sensor. It behaves like a **charged paddle** (**Figure 40-17**), in that it can move through the interior of the membrane transferring four positive charges (due to four Arg residues in each subunit) from one membrane surface to the other in response to changes in voltage. There are four voltage sensors in each channel, linked to the gate. The gate part of the channel is constructed from S6 helices (one from each of the subunits). Movements of this part of the channel in response to changing voltage effectively close the channel or reopen it, in the latter case allowing a current of ions to cross.

Ionophores Are Molecules That Act as Membrane Shuttles for Various Ions

Certain microbes synthesize small cyclic organic molecules, **ionophores**, such as **valinomycin** that function as shuttles for the movement of ions (K^+ in the case of valinomycin) across membranes. Ionophores contain hydrophilic centers that are surrounded by peripheral hydrophobic regions. Specific ions bind within the hydrophilic center of the molecule, which then diffuses through the membrane efficiently delivering the ion in question to the cytosol. Other ionophores (the polypeptide antibiotic **gramicidin**) fold up to form hollow channels through which ions can traverse the membrane.

Microbial toxins such as **diphtheria toxin** and activated **serum complement components** can produce large pores in cellular membranes and thereby provide macromolecules with

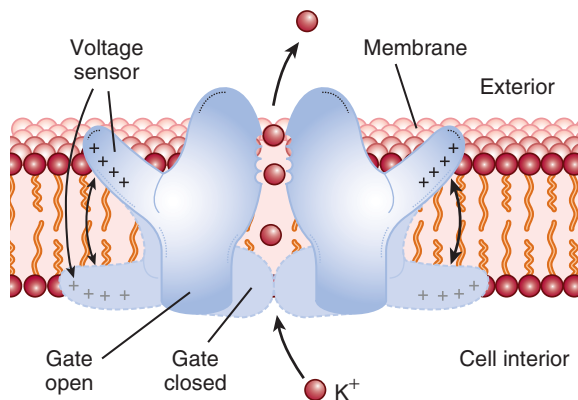

FIGURE 40-17 Schematic diagram of the voltage-gated K^+ channel of *Aeropyrum pernix*. The voltage sensors behave like charged paddles that move through the interior of the membrane. Four voltage sensors (only two are shown here) are linked mechanically to the gate of the channel. Each sensor has four positive charges contributed by arginine residues. (Modified, with permission, from Sigworth FJ: Nature 2003;423:21. Copyright © 2003. Macmillan Publishers Ltd.)

direct access to the internal milieu. The toxin α -hemolysin (produced by certain species of *Streptococcus*) consists of seven subunits that come together to form a β -barrel that allows metabolites like ATP to leak out of cells, resulting in cell lysis.

Aquaporins Are Proteins That Form Water Channels in Certain Membranes

In certain cells (eg, red cells and cells of the collecting ductules of the kidney), the movement of water by simple diffusion is augmented by movement through **water channels**. These channels are composed of tetrameric transmembrane proteins named **aquaporins**. At least 10 distinct aquaporins (AP-1 to AP-10) have been identified. Crystallographic and other studies have revealed how these channels permit passage of water but exclude passage of ions and protons. In essence, the pores are too narrow to permit passage of ions. Protons are excluded by the fact that the oxygen atom of water binds to two asparagine residues lining the channel, making the water unavailable to participate in an H^+ relay, and thus preventing entry of protons. Mutations in the gene encoding AP-2 have been shown to be the cause of one type of **nephrogenic diabetes insipidus**, a condition in which there is an inability to concentrate urine.

ACTIVE TRANSPORT SYSTEMS REQUIRE A SOURCE OF ENERGY

The process of active transport differs from diffusion in that molecules are transported against concentration gradients; hence, energy is required. This energy can come from the hydrolysis of ATP, from electron movement, or from light. The **maintenance of electrochemical gradients** in biologic

TABLE 40-6 Major Types of ATP-Driven Active Transporters

Type	Example With Subcellular Location
P-type	Ca^{2+} ATPase (SR); Na^+-K^+ -ATPase (PM)
F-type	mt ATP synthase of oxidative phosphorylation
V-type	The ATPase that pumps protons into lysosomes and synaptic vesicles
ABC transporter	CFTR protein (PM); MDR-1 protein (PM)

P (in P-type) signifies phosphorylation (these proteins autophosphorylate).

F (in F-type) signifies energy coupling factors.

V (in V-type) signifies vacuolar.

ABC signifies ATP-binding cassette transporter (all have two nucleotide-binding domains and two transmembrane segments).

SR, sarcoplasmic reticulum of muscle; PM, plasma membrane; mt, mitochondrial; CFTR, cystic fibrosis transmembrane regulator protein, a Cl^- transporter, and the protein implicated in the causation of cystic fibrosis (see later in this chapter and also Chapter 57); MDR-1 protein (multidrug resistance-1 protein), a protein that pumps many chemotherapeutic agents out of cancer cells and is thus an important contributor to the resistance of certain cancer cells to treatment.

systems is so important that it consumes approximately **30% of the total energy expenditure** in a cell.

As shown in Table 40-6, **four major classes of ATP-driven active transporters** (P, F, V, and ABC transporters) have been recognized. The nomenclature is explained in the legend to the table. The first example of the P class, the Na^+-K^+ -ATPase, is discussed below. The Ca^{2+} ATPase of muscle is discussed in Chapter 51. The second class is referred to as F-type. The most important example of this class is the mt ATP synthase, described in Chapter 13. V-type active transporters pump protons into lysosomes and other structures. ABC transporters include the **CFTR** protein, a chloride channel involved in the causation of cystic fibrosis (described later in this chapter and in Chapter 58). Another important member of this class is the multidrug resistance-1 protein (**MDR-1** protein). This transporter will pump a variety of drugs, including many anticancer agents, out of cells. It is a very important cause of cancer cells exhibiting resistance to chemotherapy, although many other mechanisms are also implicated.

The Na^+-K^+ -ATPase of the Plasma Membrane Is a Key Enzyme in Regulating Intracellular Concentrations of Na^+ and K^+

As shown in Table 40-1 cells maintain a low intracellular Na^+ concentration and a high intracellular K^+ concentration (Table 40-1), along with a net negative electrical potential inside. The pump that maintains these ionic gradients is an ATPase that is activated by Na^+ and K^+ (**Na^+-K^+ -ATPase**). The Na^+-K^+ -ATPase pumps three Na^+ out and two K^+ into cells (Figure 40-18). This pump is an integral membrane protein that contains a transmembrane domain allowing the passage of ions, and cytosolic domains that couple ATP hydrolysis to transport. There are catalytic centers for both ATP and Na^+ on the cytoplasmic (inner) side of the plasma membrane (PM), while there are K^+ binding sites located on the

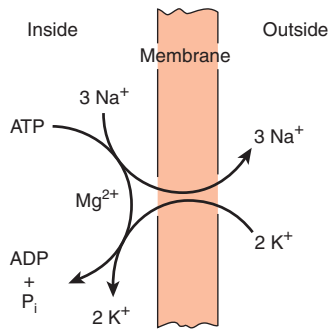

FIGURE 40–18 Stoichiometry of the $\text{Na}^+\text{-K}^+\text{-ATPase}$ pump.

This pump moves three Na^+ ions from inside the cell to the outside and brings two K^+ ions from the outside to the inside for every molecule of ATP hydrolyzed to ADP by the membrane-associated ATPase. Ouabain and other cardiac glycosides inhibit this pump by acting on the extracellular surface of the membrane. (Courtesy of R Post.)

extracellular side of the membrane. Phosphorylation by ATP induces a conformational change in the protein leading to the transfer of three Na^+ ions from the inner to the outer side of the plasma membrane. Two molecules of K^+ bind to sites on the protein on the external surface of the cell membrane, resulting in dephosphorylation of the protein and transfer of the K^+ ions across the membrane to the interior. Thus, three Na^+ ions are transported out for every two K^+ ions entering. This differential ion transport creates a charge imbalance between the inside and the outside of the cell, making the cell interior more negative (an **electrogenic** effect). Two clinically important cardiac drugs **ouabain** and **digitalis**, inhibit the $\text{Na}^+\text{-K}^+\text{-ATPase}$ by binding to the extracellular domain. This enzyme can consume significant amounts of cellular ATP energy. The $\text{Na}^+\text{-K}^+\text{-ATPase}$ can be coupled to various other transporters, such as those involved in transport of glucose (see below).

TRANSMISSION OF NERVE IMPULSES INVOLVES ION CHANNELS AND PUMPS

The membrane enclosing **neuronal cells** maintains an asymmetry of inside-outside voltage (electrical potential) and is also **electrically excitable** due to the presence of voltage-gated channels. When appropriately stimulated by a chemical signal mediated by a specific synaptic membrane receptor (see discussion of the transmission of biochemical signals, below), channels in the membrane are opened to allow the rapid influx of Na^+ or Ca^{2+} (with or without the efflux of K^+), so that the voltage difference rapidly collapses and that segment of the membrane is **depolarized**. However, as a result of the action of the ion pumps in the membrane, the gradient is quickly restored.

When large areas of the membrane are **depolarized** in this manner, the electrochemical disturbance propagates in wave-like form down the membrane, generating a **nerve impulse**. **Myelin sheets**, formed by Schwann cells, wrap around nerve

fibers and provide an **electrical insulator** that surrounds most of the nerve and greatly speeds up the propagation of the wave (signal) by allowing ions to flow in and out of the membrane only where the membrane is free of the insulation (at the **nodes of Ranvier**). The myelin membrane has a very high lipid content that accounts for its excellent insulating property. Relatively few proteins are found in the myelin membrane; those present appear to hold together multiple membrane bilayers to form the hydrophobic insulating structure that is impermeable to ions and water. Certain diseases, for example, **multiple sclerosis** and the **Guillain-Barré syndrome**, are characterized by demyelination and impaired nerve conduction.

TRANSPORT OF GLUCOSE INVOLVES SEVERAL MECHANISMS

A discussion of the transport of glucose summarizes many of the points discussed above. Glucose must enter cells as the first step in energy utilization. A number of different glucose transporters (GLUTs) are involved, varying in different tissues (see Table 19–2). In adipocytes and skeletal muscle, glucose enters by a specific transport system (GLUT4) that is enhanced by insulin. Changes in transport are primarily due to alterations of V_{max} (presumably from more or fewer transporters), but changes in K_m may also be involved.

Glucose transport in the small intestine involves some different aspects of the principles of transport discussed above. Glucose and Na^+ bind to different sites on a **$\text{Na}^+\text{-glucose symporter}$** located at the **apical surface**. Na^+ moves into the cell down its electrochemical gradient and “drags” glucose with it (**Figure 40–19**). Therefore, the greater the Na^+ gradient, the more glucose enters; and if Na^+ in extracellular fluid is low, glucose transport stops. To maintain a steep Na^+ gradient, this $\text{Na}^+\text{-glucose}$ symporter is dependent on gradients generated by the $\text{Na}^+\text{-K}^+\text{-ATPase}$, which maintains a low intracellular Na^+ concentration. Similar mechanisms are used to transport other sugars as well as amino acids across the apical lumen in polarized cells such as are found in the intestine and kidney. The transcellular movement of glucose in this case involves one additional component: a uniporter (**Figure 40–19**) that allows the glucose accumulated within the cell to move across the **basolateral membrane** and involves a **glucose uniporter** (GLUT2).

The treatment of severe cases of **diarrhea** (such as is found in cholera) makes use of the above information. In **cholera** (see Chapter 57), massive amounts of fluid can be passed as watery stools in a very short time, resulting in severe dehydration and possibly death. **Oral rehydration therapy**, consisting primarily of **NaCl and glucose**, has been developed by the World Health Organization (WHO). The transport of glucose and Na^+ across the intestinal epithelium forces (via osmosis) movement of water from the lumen of the gut into intestinal cells, resulting in rehydration. Glucose alone or NaCl alone would not be effective.

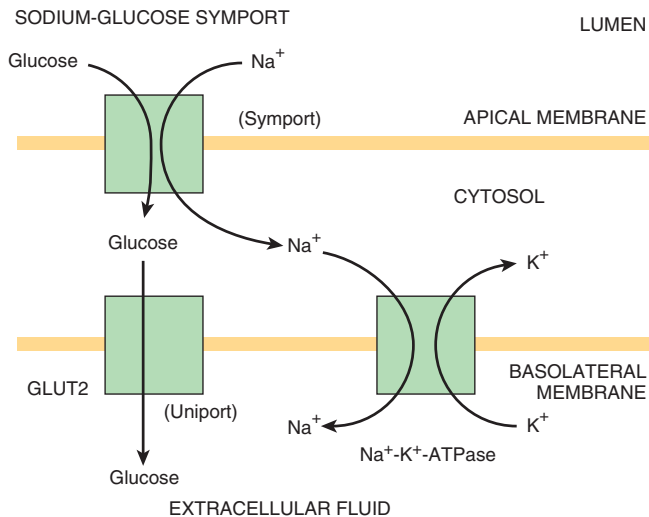

FIGURE 40-19 The transcellular movement of glucose in an intestinal cell. Glucose follows Na^+ across the luminal epithelial membrane. The Na^+ gradient that drives this symport is established by Na^+ - K^+ exchange, which occurs at the basal membrane facing the extracellular fluid compartment via the action of the Na^+ - K^+ -ATPase. Glucose at high concentration within the cell moves “downhill” into the extracellular fluid by facilitated diffusion (a uniport mechanism), via GLUT2 (a glucose transporter, see Table 19-2). The sodium-glucose symport actually carries 2 Na^+ for each glucose.

CELLS TRANSPORT CERTAIN MACROMOLECULES ACROSS THE PLASMA MEMBRANE BY ENDOCYTOSIS AND EXOCYTOSIS

The process by which cells take up large molecules is called **endocytosis**. Some of these molecules (eg, polysaccharides, proteins, and polynucleotides), when hydrolyzed inside the cell, **yield nutrients**. Endocytosis also provides a mechanism for **regulating** the content of certain membrane components, hormone receptors being a case in point. Endocytosis can be used to learn more about how cells function. DNA from one cell type can be used to transfect a different cell and alter the latter’s function or phenotype. A specific gene is often employed in these experiments, and this provides a unique way to study and analyze the regulation of that gene. **DNA transfection** depends upon endocytosis, which is responsible for the entry of DNA into the cell. Such experiments commonly use calcium phosphate since Ca^{2+} stimulates endocytosis and precipitates DNA, which makes the DNA a better object for endocytosis (see Chapter 39). Cells also **release macromolecules** by **exocytosis**. Endocytosis and exocytosis both involve vesicle formation with or from the plasma membrane.

Endocytosis Involves Ingestion of Parts of the Plasma Membrane

Almost all eukaryotic cells are continuously recycling parts of their plasma membranes. Endocytotic vesicles are generated

when segments of the plasma membrane invaginate, enclosing a small volume of extracellular fluid and its contents. The vesicle then pinches off as the fusion of plasma membranes seals the neck of the vesicle at the original site of invagination (**Figure 40-20**). The bilayer lipid membrane, or **vesicle** so generated, then fuses with other membrane structures and thus achieves the transport of its contents to other cellular compartments or even back to the cell exterior. Most endocytotic vesicles fuse with **primary lysosomes** to form **secondary lysosomes**, which contain hydrolytic enzymes and are therefore specialized organelles for intracellular disposal. The macromolecular contents are digested to yield amino acids, simple sugars, or nucleotides, and they are transported out of the vesicles to be reused by the cell. Endocytosis requires (1) energy, usually from the hydrolysis of ATP; (2) Ca^{2+} ; and (3) contractile elements in the cell (probably the microfilament system) (see Chapter 50).

There are **two** general types of endocytosis. **Phagocytosis** occurs only in specialized cells such as macrophages and granulocytes. Phagocytosis involves the ingestion of large particles such as viruses, bacteria, cells, or debris. Macrophages are extremely active in this regard and may ingest 25% of their volume per hour. In so doing, a macrophage may internalize 3% of its plasma membrane each minute or the entire membrane every 30 minutes.

Pinocytosis (“cell drinking”) is a property of all cells and leads to the cellular uptake of fluid and fluid contents.

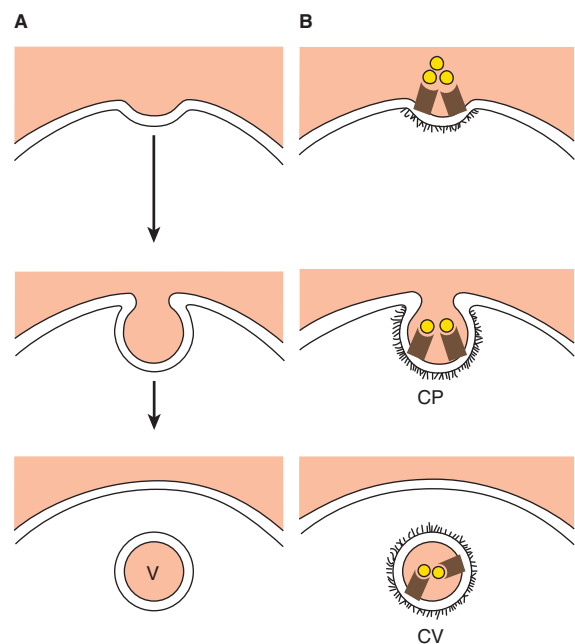

FIGURE 40-20 Two types of pinocytosis. An endocytotic vesicle (V) forms as a result of invagination of a portion of the plasma membrane. Fluid-phase pinocytosis (A) is random and nondirected. Absorptive (receptor-mediated endocytosis) (B) is selective and occurs in coated pits (CP) lined with the protein clathrin (the fuzzy material). Targeting is provided by receptors (brown symbols) specific for a variety of molecules. This results in the formation of an internalized clathrin-coated vesicle (CV).

There are two types. **Fluid-phase pinocytosis** is a nonselective process in which the uptake of a solute by formation of small vesicles is simply proportionate to its concentration in the surrounding extracellular fluid. The formation of these vesicles is an extremely active process. Fibroblasts, for example, internalize their plasma membrane at about one-third the rate of macrophages. This process occurs more rapidly than membranes are made. The surface area and volume of a cell do not change much, so membranes must be replaced by exocytosis or by being recycled as fast as they are removed by endocytosis.

The other type of pinocytosis, **absorptive pinocytosis** or **receptor-mediated endocytosis**, is primarily responsible for the uptake of specific macromolecules for which there are binding sites on the plasma membrane. These high-affinity receptors permit the selective concentration of ligands from the medium, minimize the uptake of fluid or soluble unbound macromolecules, and markedly increase the rate at which specific molecules enter the cell. The vesicles formed during absorptive pinocytosis are derived from invaginations (pits) that are coated on the cytoplasmic side with a filamentous material and are appropriately named **coated pits**. In many systems, the protein **clathrin** is the filamentous material. It has a three-limbed structure (called a **triskelion**), with each limb being made up of one light and one heavy chain of clathrin. The polymerization of clathrin into a vesicle is directed by **assembly particles**, composed of four **adapter proteins**. These interact with certain amino acid sequences in the receptors that become cargo, ensuring selectivity of uptake. The lipid **phosphatidylinositol 4,5-bisphosphate (PIP₂)** (see Chapter 21) also plays an important role in vesicle assembly. In addition, the protein **dynamin**, which both binds and hydrolyzes GTP, is necessary for the pinching off of clathrin-coated vesicles from the cell surface. Coated pits may constitute as much as 2% of the surface of some cells. Other aspects of vesicles are discussed in Chapter 49.

As an example, the **low-density lipoprotein (LDL)** molecule and its receptor (Chapter 25), are internalized by means of coated pits containing the LDL receptor. Endocytotic vesicles containing the LDL-bound LDL receptor complex fuse to lysosomes in the cell. The receptor is released and recycled back to the cell surface membrane, but the apoprotein of LDL is degraded and the cholesterol esters metabolized. Synthesis of the LDL receptor is regulated by secondary or tertiary consequences of pinocytosis, eg, by metabolic products—

such as cholesterol—released during the degradation of LDL. Disorders of the LDL receptor and its internalization are medically important and are discussed in Chapters 25 and 26.

Absorptive pinocytosis of **extracellular glycoproteins** requires that the glycoproteins carry specific carbohydrate recognition signals. These recognition signals are bound by membrane receptor molecules that play a role analogous to that of the LDL receptor. A **galactosyl receptor** on the surface of hepatocytes is instrumental in the absorptive pinocytosis of **asialoglycoproteins** from the circulation (see Chapter 46). **Acid hydrolases** taken up by absorptive pinocytosis in fibroblasts are recognized by their **mannose 6-phosphate** moieties. Interestingly, the mannose 6-phosphate moiety also seems to play an important role in the intracellular targeting of the acid hydrolases to the lysosomes of the cells in which they are synthesized (see Chapter 46).

There is a problematic side to receptor-mediated endocytosis in that **viruses** which cause such diseases as hepatitis (affecting liver cells), poliomyelitis (affecting motor neurons), and AIDS (affecting T cells) initiate their infectious cycles by entering cells via this mechanism. **Iron toxicity** also begins with excessive uptake due to endocytosis.

Exocytosis Releases Certain Macromolecules From Cells

Most cells release macromolecules to the exterior by **exocytosis**. This process is also involved in membrane remodeling, when the components synthesized in the ER and Golgi are carried in vesicles that fuse with the plasma membrane. The signal for this “classical exocytosis” (see below) is often a hormone which, when it binds to a cell-surface receptor, induces a local and transient change in Ca²⁺ concentration. Ca²⁺ triggers exocytosis. **Figure 40–21** provides a comparison of the mechanisms of exocytosis and endocytosis.

Molecules released by this mode of exocytosis have at least three fates: (1) they are membrane proteins and remain associated with the cell surface; (2) they can become part of the extracellular matrix, for example, collagen and glycosaminoglycans; (3) they can enter extracellular fluid and signal other cells. Insulin, parathyroid hormone, and the catecholamines are all packaged in granules and processed within cells, to be released upon appropriate stimulation.

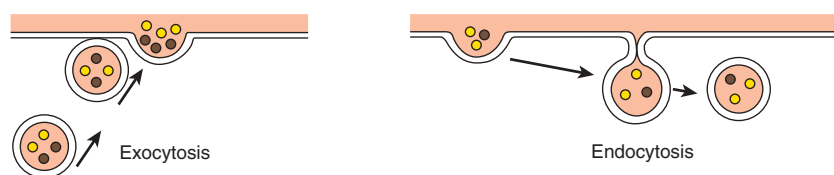

FIGURE 40–21 A comparison of the mechanisms of endocytosis and exocytosis. Exocytosis involves the contact of two inside-surface (cytoplasmic side) monolayers, whereas endocytosis results from the contact of two outer-surface monolayers.

VARIOUS SIGNALS CAN BE TRANSMITTED ACROSS MEMBRANES

Specific biochemical signals such as neurotransmitters, hormones, and immunoglobulins bind to integral transmembrane receptor proteins via their exposed extracellular domains, thereby transmitting information through the membranes to the cytoplasm. This process, called **transmembrane signaling** or **signal transduction**, involves the generation of a number of second messenger signaling molecules, including cyclic nucleotides, calcium, phosphoinositides, and diacylglycerol (see Chapter 42). Many of the steps involve phosphorylation of receptors and downstream proteins.

GAP JUNCTIONS ALLOW DIRECT FLOW OF MOLECULES FROM ONE CELL TO ANOTHER

Gap junctions are structures that permit direct transfer of small molecules (up to ~1200 Da) from one cell to its neighbor. They are composed of a family of proteins called **connexins** that form a bihexagonal structure consisting of 12 such proteins. Six connexins form a connexin hemichannel and join to a similar structure in a neighboring cell to make a complete **connexon channel** (Figure 40–22). One gap junction

contains several connexons. Different connexins are found in different tissues. Mutations in genes encoding connexins have been found to be associated with a number of conditions, including cardiovascular abnormalities, one type of deafness, and the X-linked form of Charcot-Marie-Tooth disease (a demyelinating neurologic disorder).

EXTRACELLULAR VESICLES (EXOSOMES) REPRESENT A NOVEL, AND PREVIOUSLY UNAPPRECIATED MECHANISM OF CELL-CELL COMMUNICATION

In the last decade a class of small, heterogeneous, secreted vesicles, broadly termed **extracellular vesicles**, have been identified and characterized. Extracellular vesicles have been implicated as a new, important mediator of cell-cell communication that likely contribute importantly to both normal and pathological physiology. These vesicles, enclosed by a lipid bilayer, are somewhat heterogeneous in size (30–2000 nm diameter), and are generated by at least two distinct mechanisms (Figure 40–23): **microvesicles** are generated by budding from the plasma membrane of a **source cell**; while **exosomes** are generated from the multivesicular body (MVB), a component of the endocytic membrane trafficking system described above (ie, see Figure 40–12). Exosomes are secreted from the source

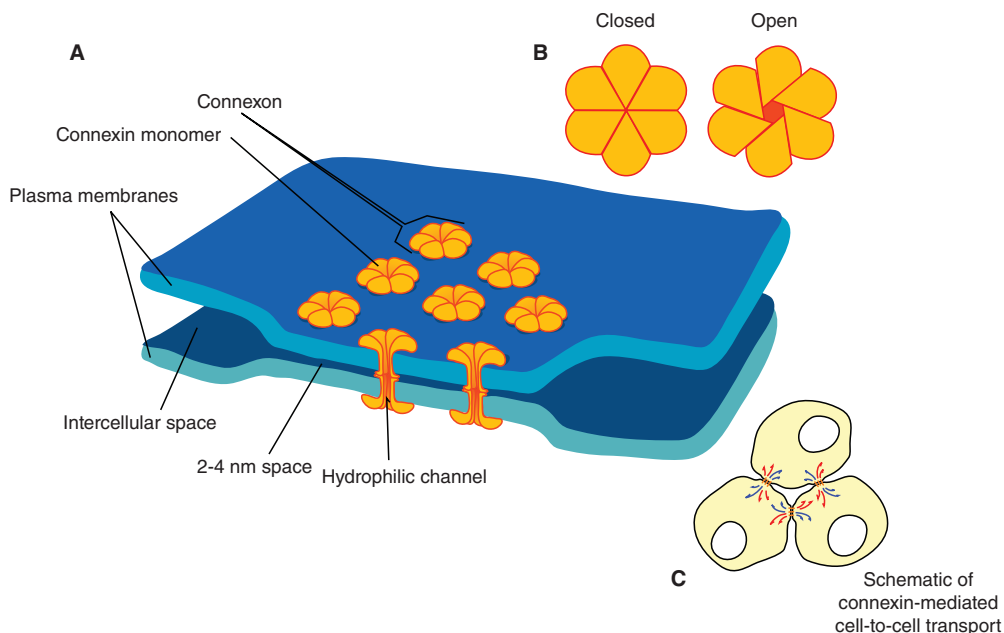

FIGURE 40–22 Schematic diagram of a gap junction. Shown schematically are (A) the relationships between cells containing connexin; (B) open and closed complete connexon channels; and (C) the flow of molecules (blue, red arrows) between a group of three cells. One connexon is made from two hemiconnexons. Each hemiconnexon is made from six connexin molecules. Small solutes are able to diffuse through the central channel when open thereby providing a direct mechanism of cell-cell communication. Note that connexins connect cells that are within 2 to 4 nm of each other. Image source: http://upload.wikimedia.org/wikipedia/commons/b/b7/Gap_cell_junction-en.svg.

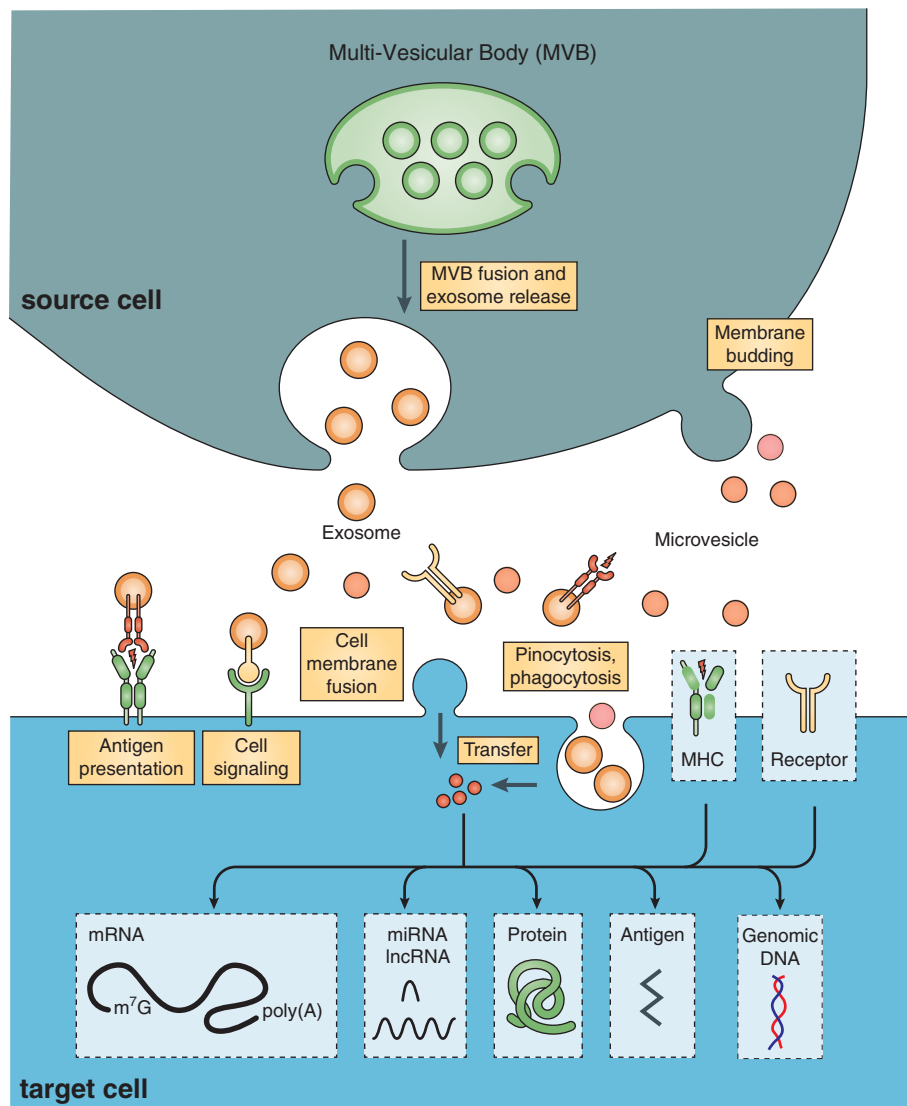

FIGURE 40–23 Cell-cell communication via extracellular vesicles. Shown are the proposed mechanisms for the formation and production of exosomes and microvesicles via endocytosis (exosome) and membrane budding (microvesicle) from a **source cell**. Vesicles produced in the multivesicular body (MVB) can be exocytosed following fusion with the plasma membrane as shown, or budded into the extracellular space. All of these processes involve the collection of proteins, lipids, and signaling molecules previously implicated in exocytosis and budding (not shown). Once released from the source cell the resulting exosomes and/or microvesicles locate their **target cell**, and following the types of vesicle-target cell interactions shown, release their contents (see black arrows within the target cell). Different vesicles have been shown to contain RNA (mRNA, miRNA, lncRNA; see Chapter 36) and DNA, specific bioactive proteins and lipids; antigens; and biologically active small molecules. Importantly, extracellular vesicles have been shown to have both positive and negative biological effects on target cells in both normal and pathological states.

cell upon fusion of the MVB and plasma membrane. In both cases the extracellular vesicles (exosomes and microvesicles) ultimately fuse to their **target cell** to deliver a distinct “payload.” Unfortunately, given the recent discovery of extracellular vesicles, the exact names and terms used to describe these vesicles, their cargos, and relevant source and target cells vary. Moreover, the terms “microvesicle” and “exosome” are often lumped together as simply “exosomes.”

Vesicle content varies from source cell to source cell and has even been reported to be different from the same source cell grown under different conditions. Vesicle payloads can include a variety of cytoplasmic and nuclear proteins, membrane-bound proteins ranging from channels to receptors, major histocompatibility complex (MHC) molecules, lipid raft-interacting proteins, DNA, mRNA, large and small ncRNAs, as well as small protein and bioactive small molecules

(Figure 40–23). Given the rich and broad diversity of vesicle/exosome contents, it is not surprising that these structures have been implicated in a very broad range of biology. Moreover, given their membrane protein content and the fact that extracellular vesicles appear to target specific recipient cells, the potential value of exosomes as therapeutic delivery systems is receiving significant interest and attention in the pharmaceutical and biotechnology industries. Future work will determine whether this new and exciting area of biomedical research on extracellular vesicles lives up to this promise.

MUTATIONS AFFECTING MEMBRANE PROTEINS CAUSE DISEASES

In view of the fact that membranes are located in so many organelles and are involved in so many processes, it is not surprising that mutations affecting their protein constituents should result in many diseases or disorders. While some mutations directly affect the function of membrane proteins, the majority cause protein misfolding that impair membrane trafficking at any of a number of steps (see Chapter 49) from their site of synthesis in the ER to the plasma membrane or other intracellular sites/organelles. Examples of diseases or disorders due to abnormalities in membrane proteins are listed in **Table 40–7**. These mainly reflect mutations in proteins of the plasma membrane, with one affecting lysosomal function (I-cell disease).

Proteins in plasma membranes can be classified as receptors, transporters, ion channels, enzymes, and structural components. Members of all of these classes are often glycosylated, so that mutations affecting this process (see Chapter 46) may alter their function. Mutations in receptors can cause defects in transmembrane signaling, a common occurrence in cancer (see Chapter 56). Many genetic diseases or disorders have been ascribed to mutations affecting various proteins involved in the transport of amino acids, sugars, lipids, urate, anions, cations, water, and vitamins across the plasma membrane.

Mutations in genes encoding proteins in other membrane-bounded compartments can also have harmful consequences. For example, mutations in genes encoding mitochondrial membrane proteins involved in oxidative phosphorylation can cause neurologic and other problems (eg, **Leber hereditary optic neuropathy [LHON]**, a condition in which some success with gene therapy has reported).

Membrane proteins can also be affected by conditions other than mutations. Formation of autoantibodies to the acetylcholine receptor in skeletal muscle causes myasthenia gravis. Ischemia can quickly affect the integrity of various ion channels in membranes. Overexpression of P-glycoprotein (MDR-1), a drug pump, results in multidrug resistance (MDR) in cancer cells. Abnormalities of membrane constituents other than proteins can also be harmful. With regard to lipids, excess of cholesterol (eg, in familial hypercholesterolemia), of lysophospholipid (eg, after bites by certain snakes, whose venom contains phospholipases), or of glycosphingolipids (eg, in

a sphingolipidosis), can all affect membrane structure and hence function.

Cystic Fibrosis Is due to Mutations in the Gene Encoding CFTR, a Chloride Transporter

Cystic fibrosis (CF) is a recessive genetic disorder prevalent among whites in North America and certain parts of northern Europe. CF is characterized by chronic bacterial infections of the airways and sinuses, fat maldigestion due to pancreatic exocrine insufficiency, infertility in males due to abnormal development of the vas deferens, and elevated levels of chloride in sweat (>60 mmol/L). It is now known that mutations in a gene encoding a protein named **cystic fibrosis transmembrane regulator protein (CFTR)** is responsible for CF. CFTR is a cyclic AMP-regulated Cl⁻ transporter. The major clinical features of CF and further information about the gene responsible for CF and about CFTR are presented in Case 5, Chapter 57.

TABLE 40–7 Some Diseases or Pathologic States Resulting From or Attributed to Abnormalities of Membranes^a

Disease	Abnormality
Achondroplasia (OMIM 100800)	Mutations in the gene encoding the fibroblast growth factor receptor 3
Familial hypercholesterolemia (OMIM 143890)	Mutations in the gene encoding the LDL receptor
Cystic fibrosis (OMIM 219700)	Mutations in the gene encoding the CFTR protein, a Cl ⁻ transporter
Congenital long QT syndrome (OMIM 192500)	Mutations in genes encoding ion channels in the heart
Wilson disease (OMIM 277900)	Mutations in the gene encoding a copper-dependent ATPase
I-cell disease (OMIM 252500)	Mutations in the gene encoding GlcNAc phosphotransferase, resulting in absence of the Man 6-P signal for lysosomal localization of certain hydrolases
Hereditary spherocytosis (OMIM 182900)	Mutations in the genes encoding spectrin or other structural proteins in the red cell membrane
Metastasis of cancer cells	Abnormalities in the oligosaccharide chains of membrane glycoproteins and glycolipids are thought to be of importance
Paroxysmal nocturnal hemoglobinuria (OMIM 311770)	Mutation resulting in deficient attachment of the GPI anchor (see Chapter 46) to certain proteins of the red cell membrane

^aThe disorders listed are discussed further in other chapters. The table lists examples of mutations affecting two receptors, one transporter, several ion channels (ie, congenital long QT syndrome), two enzymes, and one structural protein. Examples of altered or defective glycosylation of glycoproteins are also presented. Most of the conditions listed involve the plasma membrane.

SUMMARY

- Membranes are complex dynamic structures composed of lipids, proteins, and carbohydrate-containing molecules.
- The basic structure of all membranes is the lipid bilayer. This bilayer is formed by two sheets of phospholipids in which the hydrophilic polar head groups are directed away from each other and are exposed to the aqueous environment on the outer and inner surfaces of the membrane. The hydrophobic nonpolar tails of these molecules are oriented toward each other, in the direction of the center of the membrane.
- Membranes are very dynamic structures. Lipids and certain proteins show rapid lateral diffusion. Flip-flop is very slow for lipids and almost nonexistent for proteins.
- The fluid mosaic model forms a useful basis for thinking about membrane structure.
- Membrane proteins are classified as integral if they are firmly embedded in the bilayer and as peripheral if they are attached to the outer or inner membrane surface.
- The 20 or so membranes in a mammalian cell have different compositions and functions and they define essential compartments, or specialized environments, within the cell that have specific functions (eg, lysosomes).
- Certain hydrophobic molecules freely diffuse across membranes, but the movement of others is restricted because of their size and/or charge.
- Various passive and active (usually ATP-dependent) mechanisms are employed to maintain gradients of many different molecules across different membranes.
- Certain solutes, eg, glucose, enter cells by facilitated diffusion along a downhill gradient from high to low concentration using specific carrier proteins (transporters).
- The major ATP-driven pumps are classified as P (phosphorylated), F (energy factors), V (vacuolar), and ABC transporters. Member of these classes include the Na⁺-K⁺-ATPase and the Ca²⁺ ATPase of the sarcoplasmic reticulum; the mt ATP synthase; the ATPase acidifying lysosomes; and the CFTR protein and the MDR-1 protein.

- Ligand- or voltage-gated ion channels are often employed to move charged molecules (Na⁺, K⁺, Ca²⁺, etc) across membranes down their electrochemical gradients.
- Large molecules can enter or leave cells through mechanisms such as endocytosis or exocytosis. These processes often require binding of the molecule to a receptor, which affords specificity to the process.
- Extracellular vesicles (exosomes) allow direct movement of macromolecules from cell to cell via small vesicles. Exosome payloads can include specific lipids, proteins (receptors, channels, signaling proteins) DNA, RNAs and small bioactive molecules. This new area of membrane trafficking and cell-cell communication has tremendous potential to impact thinking and practice about normal and abnormal biology.
- Mutations that affect the structure of membrane proteins (receptors, transporters, ion channels, enzymes, and structural proteins) may cause diseases; examples include cystic fibrosis and familial hypercholesterolemia.

REFERENCES

- Alberts B, Johnson A, Lewis J, et al: *Molecular Biology of the Cell*, 5th ed. Garland Science, 2008.
- Cooper GM, Hausman RE: *The Cell, A Molecular Approach*. Sinauer Assoc Inc., 2013.
- Doherty GJ, McMahon HT: Mechanisms of endocytosis. *Annu Rev Biochem* 2009;78:857.
- Lodish H, Berk A, Kaiser CA, et al: *Molecular Cell Biology*, 7th ed. WH Freeman & Co, 2012.
- Longo N: Inherited defects of membrane transport. In: *Harrison's Principles of Internal Medicine*, 17th ed. Fauci AS, et al (editors). Chapter 359. McGraw-Hill, 2008.
- Pollard TD, Earnshaw WC: *Cell Biology*, 2nd ed. Saunders Elsevier, 2008.
- Raposo G, Stoorvogel W: Extracellular vesicles: exosomes, microvesicles, and friends. *J Cell Biol* 2013;200:373-383.
- Singer SJ: Some early history of membrane molecular biology. *Annu Rev Physiol* 2004;66:1.
- Vance DE, Vance J (editors): *Biochemistry of Lipids, Lipoproteins and Membranes*, 5th ed. Elsevier, 2008.
- Voelker DR: Genetic and biochemical analysis of non-vesicular lipid traffic. *Annu Rev Biochem* 2009;78:827.

The Diversity of the Endocrine System

P. Anthony Weil, PhD

OBJECTIVES

After studying this chapter, you should be able to:

- Explain the basic principles of endocrine hormone action, including the determinants of hormone target cell response and the determinants of hormone concentration at target cells.
- Understand the broad diversity and mechanisms of action of endocrine hormones.
- Appreciate the complex steps involved in the production, transport, and storage of hormones.

ACTH	Adrenocorticotrophic hormone	IGF-I	Insulin-like growth factor-I
ANF	Atrial natriuretic factor	LH	Luteotropic hormone
cAMP	Cyclic adenosine monophosphate	LPH	Lipotropin
CBG	Corticosteroid-binding globulin	MIT	Monoiodotyrosine
CG	Chorionic gonadotropin	MSH	Melanocyte-stimulating hormone
cGMP	Cyclic guanosine monophosphate	OHSD	Hydroxysteroid dehydrogenase
CLIP	Corticotropin-like intermediate lobe peptide	PNMT	Phenylethanolamine- <i>N</i> -methyltransferase
DBH	Dopamine β -hydroxylase	POMC	Pro-opiomelanocortin
DHEA	Dehydroepiandrosterone	SHBG	Sex hormone-binding globulin
DHT	Dihydrotestosterone	StAR	Steroidogenic acute regulatory (protein)
DIT	Diiodotyrosine	TBG	Thyroxine-binding globulin
DOC	Deoxycorticosterone	TEBG	Testosterone-estrogen-binding globulin
EGF	Epidermal growth factor	TRH	Thyrotropin-releasing hormone
FSH	Follicle-stimulating hormone	TSH	Thyrotropin-stimulating hormone
GH	Growth hormone		

BIOMEDICAL IMPORTANCE

The survival of multicellular organisms depends on their ability to adapt to a constantly changing environment. Intercellular communication mechanisms are necessary requirements for this adaptation. The nervous system and the endocrine system provide this intercellular, organism-wide communication. The nervous system was originally viewed as providing a fixed communication system, whereas the endocrine system supplied hormones, which are mobile messages. In fact, there is a remarkable convergence of these regulatory systems. For example, neural regulation of the endocrine system is important in the production and secretion of some hormones; many neurotransmitters resemble hormones in their synthesis, transport, and mechanism of action; and many hormones are synthesized in the nervous system. The word “hormone” is derived from a Greek term that means to arouse to

activity. As classically defined, a hormone is a substance that is synthesized in one organ and transported by the circulatory system to act on another tissue. However, this original description is too restrictive because hormones can act on adjacent cells (paracrine action) and on the cell in which they were synthesized (autocrine action) without entering the systemic circulation. A diverse array of hormones—each with distinctive mechanisms of action and properties of biosynthesis, storage, secretion, transport, and metabolism—has evolved to provide homeostatic responses. This biochemical diversity is the topic of this chapter.

THE TARGET CELL CONCEPT

There are over 200 types of differentiated cells in humans. Only a few produce hormones, but virtually all of the 75 trillion cells in a human are targets of one or more of the 50⁺ known hormones.

TABLE 41-1 Determinants of the Concentration of a Hormone at the Target Cell

The rate of synthesis and secretion of the hormones.
The proximity of the target cell to the hormone source (dilution effect).
The affinity (dissociation constant; K_d) of the hormone with specific plasma transport proteins (if any).
The conversion of inactive or suboptimally active forms of the hormone into the fully active form.
The rate of clearance of hormone from plasma, by other tissues, or by digestion, metabolism, or excretion.

The concept of the target cell is a useful way of looking at hormone action. It was thought that hormones affected a single cell type—or only a few kinds of cells—and that a hormone elicited a unique biochemical or physiologic action. We now know that a given hormone can affect several different cell types; that more than one hormone can affect a given cell type; and that hormones can exert many different effects in one cell or in different cells. With the discovery of specific cell-surface and intracellular hormone receptors, the definition of a target has been expanded to include any cell in which the hormone (ligand) binds to its receptor, whether or not a biochemical or physiologic response has yet been determined.

Several factors determine the response of a target cell to a hormone. These can be thought of in two general ways: (1) as factors that affect the concentration of the hormone at the target cell (**Table 41-1**) and (2) as factors that affect the actual response of the target cell to the hormone (**Table 41-2**).

HORMONE RECEPTORS ARE OF CENTRAL IMPORTANCE

Receptors Discriminate Precisely

One of the major challenges faced in making the hormone-based communication system work is illustrated in **Figure 41-1**. Hormones are present at very low concentrations in the extracellular fluid, generally in the atto- to nanomolar range (10^{-15} to 10^{-9} mol/L). This concentration is much lower than that

TABLE 41-2 Determinants of the Target Cell Response

The number, relative activity, and state of occupancy of the specific receptors on the plasma membrane or in the cytoplasm or nucleus.
The metabolism (activation or inactivation) of the hormone in the target cell.
The presence of other factors within the cell that are necessary for the hormone response.
Up- or downregulation of the receptor consequent to the interaction with its ligand.
Postreceptor desensitization of the cell, including downregulation of the receptor.

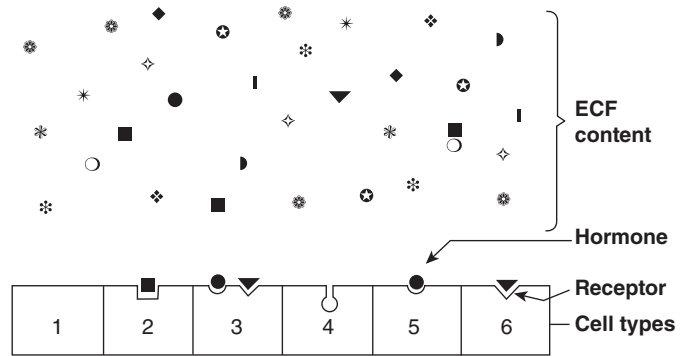

FIGURE 41-1 Specificity and selectivity of hormone receptors. Many different molecules circulate in the extracellular fluid (ECF), but only a few are recognized by hormone receptors. Receptors must select these molecules from among high concentrations of the other molecules. This simplified drawing shows that a cell may have no hormone receptors (Cell type 1), have one receptor (Cell types 2+5+6), have receptors for several hormones (Cell type 3), or have a receptor but no hormone in the vicinity (Cell type 4).

of the many structurally similar molecules (sterols, amino acids, peptides, and proteins) and other molecules that circulate at concentrations in the micro- to millimolar (10^{-6} to 10^{-3} mol/L) range. Target cells, therefore, must distinguish not only between different hormones present in small amounts but also between a given hormone and the 10^6 - to 10^9 -fold excess of other similar molecules. This high degree of discrimination is provided by cell-associated recognition molecules called receptors. Hormones initiate their biologic effects by binding to specific receptors, and since any effective control system also must provide a means of stopping a response, hormone-induced actions generally but not always terminate when the effector dissociates from the receptor (see **Figure 38-1**; Type A response).

A target cell is defined by its ability to selectively bind a given hormone to its cognate receptor. Several biochemical features of this interaction are important in order for hormone-receptor interactions to be physiologically relevant: (1) binding should be specific, ie, displaceable by agonist or antagonist; (2) binding should be saturable; and (3) binding should occur within the concentration range of the expected biologic response.

Both Recognition & Coupling Domains Occur on Receptors

All receptors have at least two functional domains. A recognition domain binds the hormone ligand and a second region generates a signal that couples hormone recognition to some intracellular function. This coupling, or signal transduction, occurs in two general ways. Polypeptide and protein hormones and the catecholamines bind to receptors located in the plasma membrane and thereby generate a signal that regulates various intracellular functions, often by changing the activity of an enzyme. In contrast, steroid, retinoid, and thyroid hormones interact with intracellular receptors, and it is this

ligand-receptor complex that directly provides the signal, generally to specific genes whose rate of transcription is thereby affected.

The domains responsible for hormone recognition and signal generation have been identified in the protein polypeptide and catecholamine hormone receptors. Steroid, thyroid, and retinoid hormone receptors have several functional domains: one site binds the hormone; another binds to specific DNA regions; a third is involved in the interaction with other coregulator proteins that result in the activation (or repression) of gene transcription; and a fourth may specify binding to one or more other proteins that influence the intracellular trafficking of the receptor (see Figure 38–19).

The dual functions of binding and coupling ultimately define a receptor, and it is the coupling of hormone binding to signal transduction—so-called **receptor-effector coupling**—that provides the first step in amplification of the hormonal response. This dual purpose also distinguishes the target cell receptor from the plasma carrier proteins that bind hormone but do not generate a signal (see Table 41–6).

Receptors Are Proteins

Several classes of peptide hormone receptors have been defined. For example, the insulin receptor is a heterotetramer composed of two copies of two different protein subunits (α , β) linked by multiple disulfide bonds in which the extracellular α subunit binds insulin and the membrane-spanning β subunit transduces the signal through the tyrosine protein kinase domain located in the cytoplasmic portion of this polypeptide. The receptors for insulin-like growth factor I (IGF-I) and epidermal growth factor (EGF) are generally similar in structure to the insulin receptor. The growth hormone and prolactin receptors also span the plasma membrane of target cells but do not contain intrinsic protein kinase activity. Ligand binding to these receptors, however, results in the association and activation of a completely different protein kinase signaling pathway, the JakStat pathway. Polypeptide hormone and catecholamine receptors, which transduce signals by altering the rate of production of cAMP through G-proteins, are characterized by the presence of seven domains that span the plasma membrane. Protein kinase activation and the generation of cyclic AMP (cAMP, 3′5′-adenylic acid; see Figure 18–5) is a downstream action of this class of receptor (see Chapter 42 for further details).

A comparison of several different steroid receptors with thyroid hormone receptors revealed a remarkable conservation of the amino acid sequence in certain regions, particularly in the DNA-binding domains. This led to the realization that receptors of the steroid or thyroid type are members of a large superfamily of nuclear receptors. Many related members of this family currently have no known ligand and thus are called orphan receptors. The nuclear receptor superfamily plays a critical role in the regulation of gene transcription by hormones, as described in Chapter 42.

HORMONES CAN BE CLASSIFIED IN SEVERAL WAYS

Hormones can be classified according to chemical composition, solubility properties, location of receptors, and the nature of the signal used to mediate hormonal action within the cell. A classification based on the last two properties is illustrated in Table 41–3, and general features of each group are illustrated in Table 41–4.

The hormones in group I are lipophilic. After secretion, these hormones associate with plasma transport or carrier proteins, a process that circumvents the problem of solubility while prolonging the plasma half-life of the hormone. The relative percentages of bound and free hormone are determined by the amount, binding affinity, and binding capacity of the transport protein. The free hormone, which is the biologically active form, readily traverses the lipophilic plasma membrane of all cells and encounters receptors in either the cytosol or nucleus of target cells. The ligand-receptor complex is the intracellular messenger in this group.

The second major group consists of water-soluble hormones that bind to specific receptors spanning the plasma membrane of the target cell. Hormones that bind to these surface receptors of cells communicate with intracellular metabolic processes through intermediary molecules called **second messengers** (the hormone itself is the first messenger), which are generated as a consequence of the ligand-receptor interaction. The second messenger concept arose from an observation that epinephrine binds to the plasma membrane of certain cells and increases intracellular cAMP. This was followed by a series of experiments in which cAMP was found to mediate the effects of many hormones. Hormones that employ this mechanism are shown in group II.A of Table 41–3. Atrial natriuretic factor (ANF) uses cGMP as its second messenger (group II.B). Several hormones, many of which were previously thought to affect cAMP, appear to use ionic calcium (Ca^{2+}) or metabolites of complex phosphoinositides (or both) as the intracellular second messenger signal. These are shown in group II.C of the table. The intracellular messenger for group II.D is a protein kinase-phosphatase cascades; several have been identified, and a given hormone may use more than one kinase cascade. A few hormones fit into more than one category, and assignments change as new information is discovered.

DIVERSITY OF THE ENDOCRINE SYSTEM

Hormones Are Synthesized in a Variety of Cellular Arrangements

Hormones are synthesized in discrete organs designed solely for this specific purpose, such as the thyroid (triiodothyronine), adrenal (glucocorticoids and mineralocorticoids), and the pituitary (TSH, FSH, LH, growth hormone, prolactin, ACTH). Some organs are designed to perform two distinct

TABLE 41-3 Classification of Hormones by Mechanism of Action

I. Hormones that bind to intracellular receptors
Androgens
Calcitriol (1,25(OH) ₂ -D ₃)
Estrogens
Glucocorticoids
Mineralocorticoids
Progestins
Retinoic acid
Thyroid hormones (T ₃ and T ₄)
II. Hormones that bind to cell surface receptors
A. The second messenger is cAMP
α ₂ -Adrenergic catecholamines
β-Adrenergic catecholamines
Adrenocorticotrophic hormone (ACTH)
Antidiuretic hormone (vasopressin)
Calcitonin
Chorionic gonadotropin, human (CG)
Corticotropin-releasing hormone
Follicle-stimulating hormone (FSH)
Glucagon
Lipotropin (LPH)
Luteinizing hormone (LH)
Melanocyte-stimulating hormone (MSH)
Parathyroid hormone (PTH)
Somatostatin
Thyroid-stimulating hormone (TSH)
B. The second messenger is cGMP
Atrial natriuretic factor
Nitric oxide
C. The second messenger is calcium or phosphatidylinositols (or both)
Acetylcholine (muscarinic)
α ₁ -Adrenergic catecholamines
Angiotensin II
Antidiuretic hormone (vasopressin)
Cholecystokinin
Gastrin
Gonadotropin-releasing hormone
Oxytocin
Platelet-derived growth factor (PDGF)
Substance P
Thyrotropin-releasing hormone (TRH)
D. The second messenger is a kinase or phosphatase cascade
Adiponectin
Chorionic somatomammotropin
Epidermal growth factor (EGF)
Erythropoietin (EPO)
Fibroblast growth factor (FGF)
Growth hormone (GH)
Insulin
Insulin-like growth factors I and II
Leptin
Nerve growth factor (NGF)
Platelet-derived growth factor
Prolactin

but closely related functions. For example, the ovaries produce mature oocytes and the reproductive hormones estradiol and progesterone. The testes produce mature spermatozoa and testosterone. Hormones are also produced in specialized cells within other organs such as the small intestine (glucagon-like peptide), thyroid (calcitonin), and kidney (angiotensin II).

TABLE 41-4 General Features of Hormone Classes

	Group I	Group II
Types	Steroids, iodothyronines, calcitriol, retinoids	Polypeptides, proteins, glycoproteins, catecholamines
Solubility	Lipophilic	Hydrophilic
Transport proteins	Yes	No
Plasma half-life	Long (hours to days)	Short (minutes)
Receptor	Intracellular	Plasma membrane
Mediator	Receptor-hormone complex	cAMP, cGMP, Ca ²⁺ , metabolites of complex phosphoinositols, kinase cascades

Finally, the synthesis of some hormones requires the parenchymal cells of more than one organ—for example, the skin, liver, and kidney are required for the production of 1,25(OH)₂-D₃ (calcitriol). Examples of this diversity in the approach to hormone synthesis, each of which has evolved to fulfill a specific purpose, are discussed below.

Hormones Are Chemically Diverse

Hormones are synthesized from a wide variety of chemical building blocks. A large series is derived from cholesterol. These include the glucocorticoids, mineralocorticoids, estrogens, progestins, and 1,25(OH)₂-D₃ (Figure 41-2). In some cases, a steroid hormone is the precursor molecule for another hormone. For example, progesterone is a hormone in its own right but is also a precursor in the formation of glucocorticoids, mineralocorticoids, testosterone, and estrogens. Testosterone is an obligatory intermediate in the biosynthesis of estradiol and in the formation of dihydrotestosterone (DHT). In these examples, described in detail below, the final product is determined by the cell type and the associated set of enzymes in which the precursor exists.

The amino acid tyrosine is the starting point in the synthesis of both the catecholamines and thyroid hormones tetraiodothyronine (thyroxine; T₄) and triiodothyronine (T₃) (Figure 41-2). T₃ and T₄ are unique in that they require the addition of iodine (as I⁻) for bioactivity. Since dietary iodine is very scarce in many parts of the world, an intricate mechanism for accumulating and retaining I⁻ has evolved.

Many hormones are polypeptides or glycoproteins. These range in size from the small thyrotropin-releasing hormone (TRH), a tripeptide, to single-chain polypeptides like adrenocorticotrophic hormone (ACTH; 39 amino acids), parathyroid hormone (PTH; 84 amino acids), and growth hormone (GH; 191 amino acids) (Figure 41-2). Insulin is an AB chain heterodimer of 21 and 30 amino acids, respectively. Follicle-stimulating hormone (FSH), luteinizing hormone (LH), thyroid-stimulating hormone (TSH), and chorionic gonadotropin (CG) are glycoprotein hormones of αβ heterodimeric structure. The α chain is

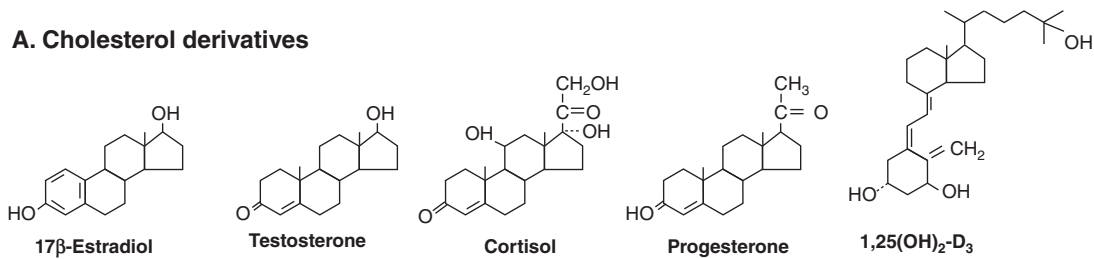
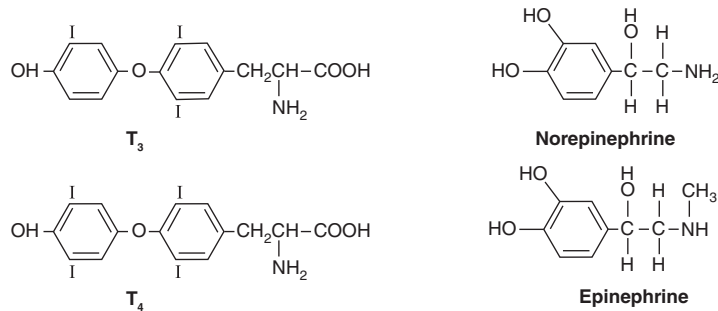
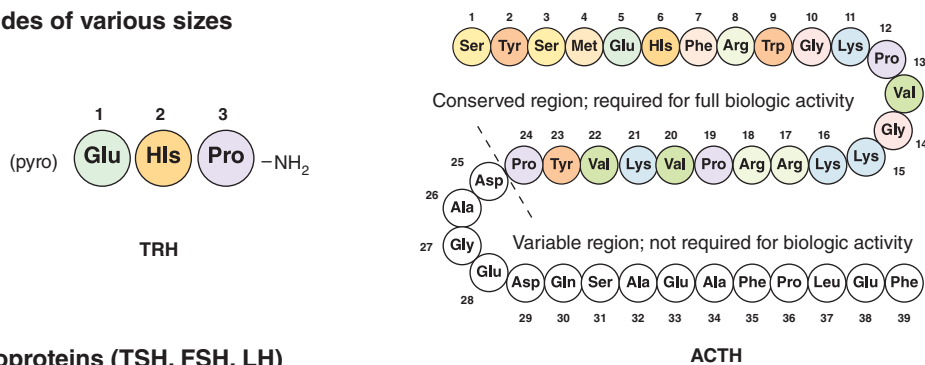
A. Cholesterol derivatives**B. Tyrosine derivatives****C. Peptides of various sizes****D. Glycoproteins (TSH, FSH, LH)**

common α subunits
unique β subunits

FIGURE 41-2 Chemical diversity of hormones. (A) cholesterol derivatives; (B) tyrosine derivatives; (C) peptides of various sizes; note: pyroglutamic acid (pyro) is a cyclized variant of glutamic acid in which side chain carboxyl and free amino groups cyclize to form a lactam. (D) glycoproteins (TSH, FSH, and LH) with common α subunits and unique β subunits.

identical in all of these hormones, and distinct β chains impart hormone uniqueness. These hormones have a molecular mass in the range of 25 to 30 kDa depending on the degree of glycosylation and the length of the β chain.

Hormones Are Synthesized & Modified for Full Activity in a Variety of Ways

Some hormones are synthesized in final form and secreted immediately. Included in this class are hormones derived from cholesterol. Some, such as the catecholamines are synthesized in final form and stored in the producing cells, while others, like insulin, are synthesized from precursor molecules in the producing cell, and then are processed and secreted upon a

physiologic cue (plasma glucose concentrations). Finally, still others are converted to active forms from precursor molecules in the periphery (T₃ and DHT). All of these examples are discussed in more detail below.

MANY HORMONES ARE MADE FROM CHOLESTEROL

Adrenal Steroidogenesis

The adrenal steroid hormones are synthesized from cholesterol, which is mostly derived from the plasma, but a small portion is synthesized in situ from acetyl-CoA via mevalonate and

squalene. Much of the cholesterol in the adrenal is esterified and stored in cytoplasmic lipid droplets. Upon stimulation of the adrenal by ACTH, an esterase is activated, and the free cholesterol formed is transported into the mitochondrion, where a **cytochrome P450 side chain cleavage enzyme (P450scc)** converts cholesterol to pregnenolone. Cleavage of the side chain involves sequential hydroxylations, first at C₂₂ and then at C₂₀, followed by side chain cleavage (removal of the six-carbon fragment isocaproaldehyde) to give the 21-carbon steroid (Figure 41-3, top). An ACTH-dependent **steroidogenic acute regulatory (StAR) protein** is essential for the transport of cholesterol to P450scc in the inner mitochondrial membrane.

All mammalian steroid hormones are formed from cholesterol via pregnenolone through a series of reactions that occur in either the mitochondria or endoplasmic reticulum of the producing cell. Hydroxylases that require molecular oxygen and NADPH are essential, and dehydrogenases, an isomerase, and a lyase reaction are also necessary for certain steps. There is cellular specificity in adrenal steroidogenesis. For instance, 18-hydroxylase and 19-hydroxysteroid dehydrogenases, which are required for aldosterone synthesis, are found only in the zona glomerulosa cells (the outer region of the adrenal cortex), so that the biosynthesis of this mineralocorticoid is confined to this region. A schematic representation of the pathways involved in the synthesis of the three major classes of adrenal steroids is presented in Figure 41-4. The enzymes are shown in the rectangular boxes, and the modifications at each step are shaded.

Mineralocorticoid Synthesis

Synthesis of aldosterone follows the mineralocorticoid pathway and occurs in the zona glomerulosa. Pregnenolone is converted to progesterone by the action of two smooth endoplasmic reticulum enzymes, **3 β -hydroxysteroid dehydrogenase (3 β -OHSd)** and **$\Delta^{5,4}$ -isomerase**. Progesterone is hydroxylated at the C₂₁ position to form 11-deoxycorticosterone (DOC), which is an active (Na⁺-retaining) mineralocorticoid. The next hydroxylation, at C₁₁, produces corticosterone, which has glucocorticoid activity and is a weak mineralocorticoid (it has <5% of the potency of aldosterone). In some species (eg, rodents), it is the most potent glucocorticoid. C₂₁ hydroxylation is necessary for both mineralocorticoid and glucocorticoid activity, but most steroids with a C₁₇ hydroxyl group have more glucocorticoid and less mineralocorticoid action. In the zona glomerulosa, which does not have the smooth endoplasmic reticulum enzyme 17 α -hydroxylase, a mitochondrial 18-hydroxylase is present. The **18-hydroxylase (aldosterone synthase)** acts on corticosterone to form 18-hydroxycorticosterone, which is changed to aldosterone by conversion of the 18-alcohol to an aldehyde. This unique distribution of enzymes and the special regulation of the zona glomerulosa by K⁺ and angiotensin II have led some investigators to suggest that, in addition to the adrenal being two glands, the adrenal cortex is actually two separate organs.

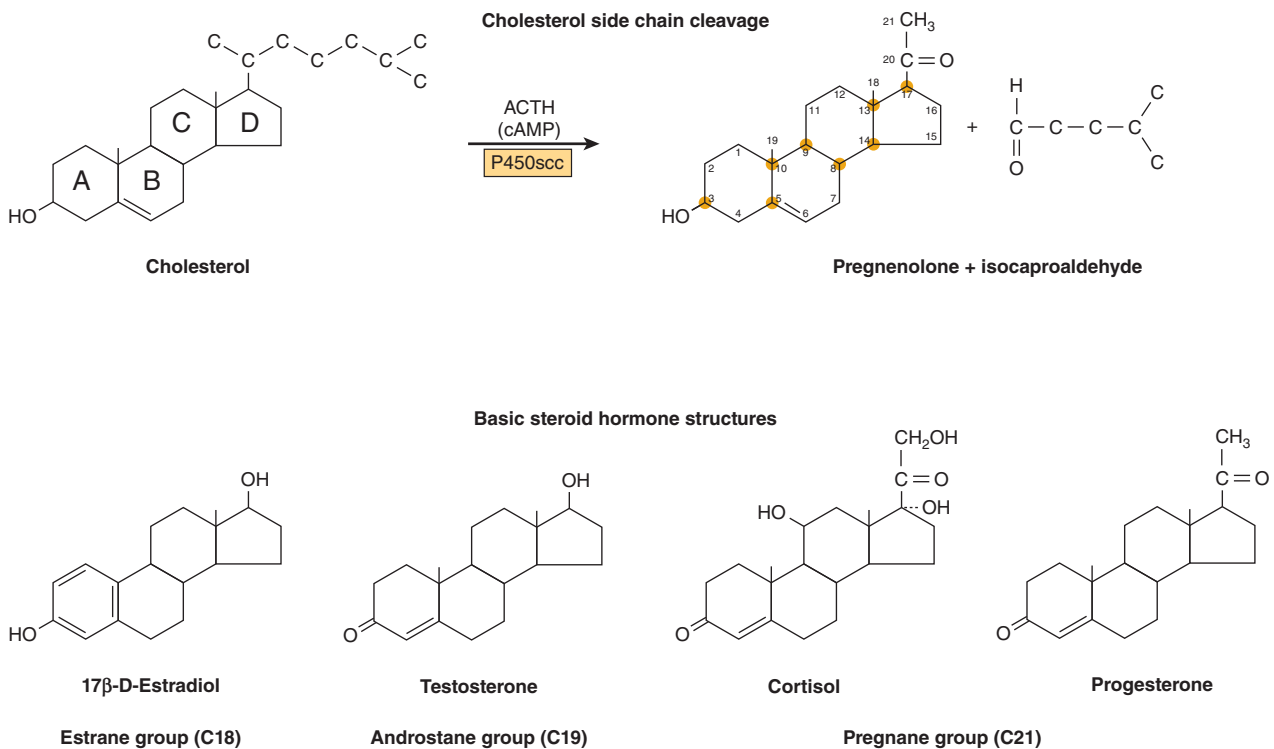

FIGURE 41-3 Cholesterol side-chain cleavage and basic steroid hormone structures. The basic sterol rings are identified by the letters A to D. The carbon atoms are numbered 1 to 21, starting with the A ring (see Figure 26-3).

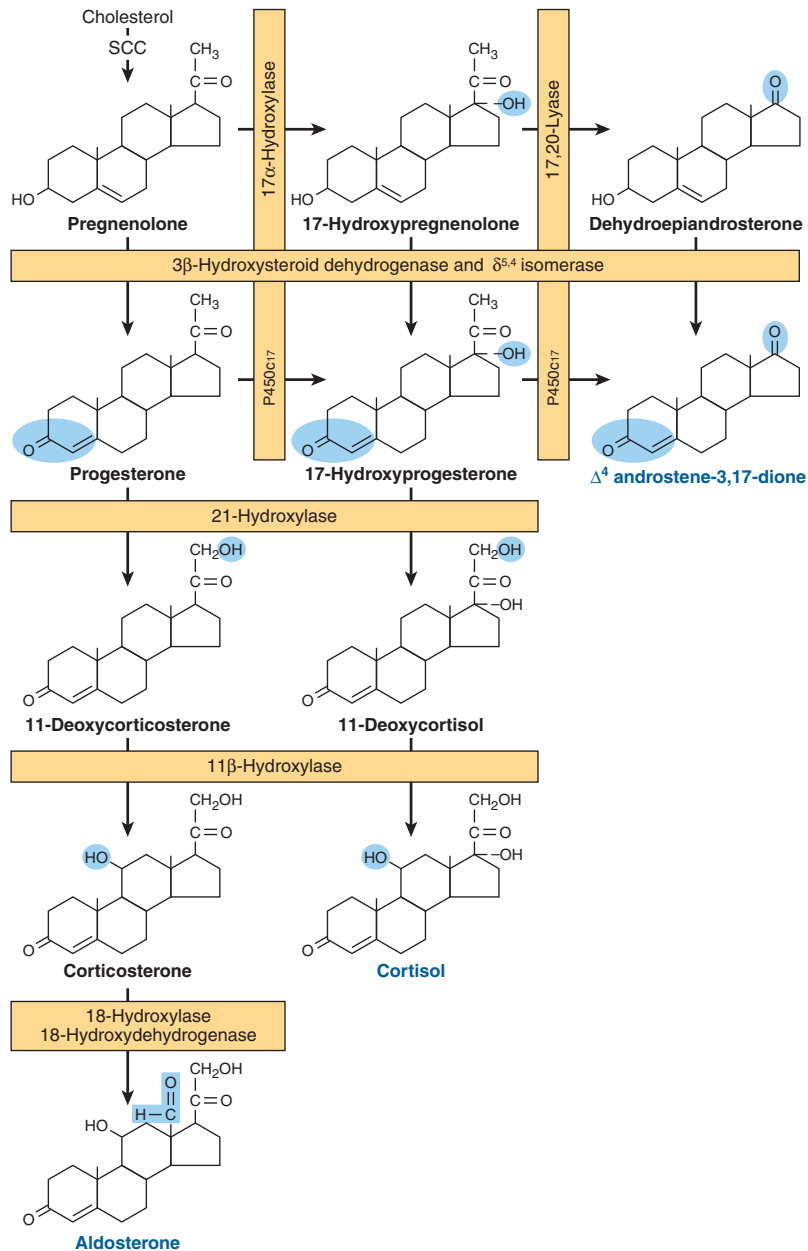

FIGURE 41-4 Pathways involved in the synthesis of the three major classes of adrenal steroids (mineralocorticoids, glucocorticoids, and androgens). Enzymes are shown in the rectangular boxes, and the modifications at each step are shaded. Note that the 17 α -hydroxylase and 17,20-lyase activities are both part of one enzyme, designated P450c17. (Slightly modified and reproduced, with permission, from Harding BW: In: *Endocrinology*, vol 2. DeGroot LJ (editor). Grune & Stratton, 1979. Copyright © 1979 Elsevier Inc. Reprinted with permission from Elsevier.)

Glucocorticoid Synthesis

Cortisol synthesis requires three hydroxylases located in the fasciculata and reticularis zones of the adrenal cortex that act sequentially on the C₁₇, C₂₁, and C₁₁ positions. The first two reactions are rapid, while C₁₁ hydroxylation is relatively slow. If the C₁₁ position is hydroxylated first, the action of 17 α -hydroxylase is impeded and the mineralocorticoid pathway is followed

(forming corticosterone or aldosterone, depending on the cell type). 17 α -Hydroxylase is a smooth endoplasmic reticulum enzyme that acts upon either progesterone or, more commonly, pregnenolone. 17 α -Hydroxyprogesterone is hydroxylated at C₂₁ to form 11-deoxycortisol, which is then hydroxylated at C₁₁ to form cortisol, the most potent natural glucocorticoid hormone in humans. 21-Hydroxylase is a smooth endoplasmic reticulum

enzyme, whereas 11β -hydroxylase is a mitochondrial enzyme. Steroidogenesis thus involves the repeated shuttling of substrates into and out of the mitochondria.

Androgen Synthesis

The major androgen or androgen precursor produced by the adrenal cortex is dehydroepiandrosterone (DHEA). Most 17 -hydroxypregnenolone follows the glucocorticoid pathway, but a small fraction is subjected to oxidative fission and removal of the two-carbon side chain through the action of $17,20$ -lyase. The lyase activity is actually part of the same enzyme (P450c17) that catalyzes 17α -hydroxylation. This is therefore a **dual-function protein**. The lyase activity is important in both the adrenals and the gonads and acts exclusively on 17α -hydroxy-containing molecules. Adrenal androgen production increases markedly if glucocorticoid biosynthesis is impeded by the lack of one of the hydroxylases (**adrenogenital syndrome**). DHEA is really a prohormone since the actions of 3β -OHSD and $\Delta^{5,4}$ -isomerase convert the weak androgen DHEA into the more potent **androstenedione**. Small amounts of androstenedione are also formed in the adrenal by the action of the lyase on 17α -hydroxyprogesterone. Reduction of androstenedione at the C_{17} position results in the formation of **testosterone**, the most potent adrenal androgen. Small amounts of testosterone are produced in the adrenal by this mechanism, but most of this conversion occurs in the testes.

Testicular Steroidogenesis

Testicular androgens are synthesized in the interstitial tissue by the Leydig cells. The immediate precursor of the gonadal steroids, as for the adrenal steroids, is cholesterol. The rate-limiting step, as in the adrenal, is delivery of cholesterol to the inner membrane of the mitochondria by the transport protein StAR. Once in the proper location, cholesterol is acted upon by the side chain cleavage enzyme P450scc. The conversion of cholesterol to pregnenolone is identical in adrenal, ovary, and testis. In the latter two tissues, however, the reaction is promoted by LH rather than ACTH.

The conversion of pregnenolone to testosterone requires the action of five enzyme activities contained in three proteins: (1) 3β -hydroxysteroid dehydrogenase (3β -OHSD) and $\Delta^{5,4}$ -isomerase; (2) 17α -hydroxylase and $17,20$ -lyase; and (3) 17β -hydroxysteroid dehydrogenase (17β -OHSD). This sequence, referred to as the **progesterone (or Δ^4)** pathway, is shown on the right side of **Figure 41–5**. Pregnenolone can also be converted to testosterone by the **dehydroepiandrosterone (or Δ^5)** pathway, which is illustrated on the left side of **Figure 41–5**. The Δ^5 route appears to be most used in human testes.

The five enzyme activities are localized in the microsomal fraction in rat testes, and there is a close functional association between the activities of 3β -OHSD and $\Delta^{5,4}$ -isomerase and between those of a 17α -hydroxylase and $17,20$ -lyase. These enzyme pairs, both contained in a single protein, are shown in the general reaction sequence in **Figure 41–5**.

DHT Is Formed From Testosterone in Peripheral Tissues

Testosterone is metabolized by two pathways. One involves oxidation at the 17 position, and the other involves reduction of the A ring double bond and the 3 -ketone. Metabolism by the first pathway occurs in many tissues, including liver, and produces 17 -ketosteroids that are generally inactive or less active than the parent compound. Metabolism by the second pathway, which is less efficient, occurs primarily in target tissues and produces the potent metabolite DHT.

The most significant metabolic product of testosterone is DHT, since in many tissues, including prostate, external genitalia, and some areas of the skin, this is the active form of the hormone. The plasma content of DHT in the adult male is about one-tenth that of testosterone, and ~ 400 μg of DHT is produced daily as compared with about 5 mg of testosterone. About 50 to 100 μg of DHT are secreted by the testes. The rest is produced peripherally from testosterone in a reaction catalyzed by the NADPH-dependent **5α -reductase (Figure 41–6)**. Testosterone can thus be considered a prohormone since it is converted into a much more potent compound (DHT) and since most of this conversion occurs outside the testes. Some estradiol is formed from the peripheral aromatization of testosterone, particularly in males.

Ovarian Steroidogenesis

The estrogens are a family of hormones synthesized in a variety of tissues. 17β -Estradiol is the primary estrogen of ovarian origin. In some species, estrone, synthesized in numerous tissues, is more abundant. In pregnancy, relatively more estrone is produced, and this comes from the placenta. The general pathway and the subcellular localization of the enzymes involved in the early steps of estradiol synthesis are the same as those involved in androgen biosynthesis. Features unique to the ovary are illustrated in **Figure 41–7**.

Estrogens are formed by the aromatization of androgens in a complex process that involves three hydroxylation steps, each of which requires O_2 and NADPH. The **aromatase enzyme complex** is thought to include a P450 monooxygenase. Estradiol is formed if the substrate of this enzyme complex is testosterone, whereas estrone results from the aromatization of androstenedione.

The cellular source of the various ovarian steroids has been difficult to unravel, but a transfer of substrates between two cell types is involved. Theca cells are the source of androstenedione and testosterone. These are converted by the aromatase enzyme in granulosa cells to estrone and estradiol, respectively. Progesterone, a precursor for all steroid hormones, is produced and secreted by the corpus luteum as an end-product hormone because these cells do not contain the enzymes necessary to convert progesterone to other steroid hormones (**Figure 41–8**).

Significant amounts of estrogens are produced by the peripheral aromatization of androgens. In human males, the peripheral aromatization of testosterone to estradiol

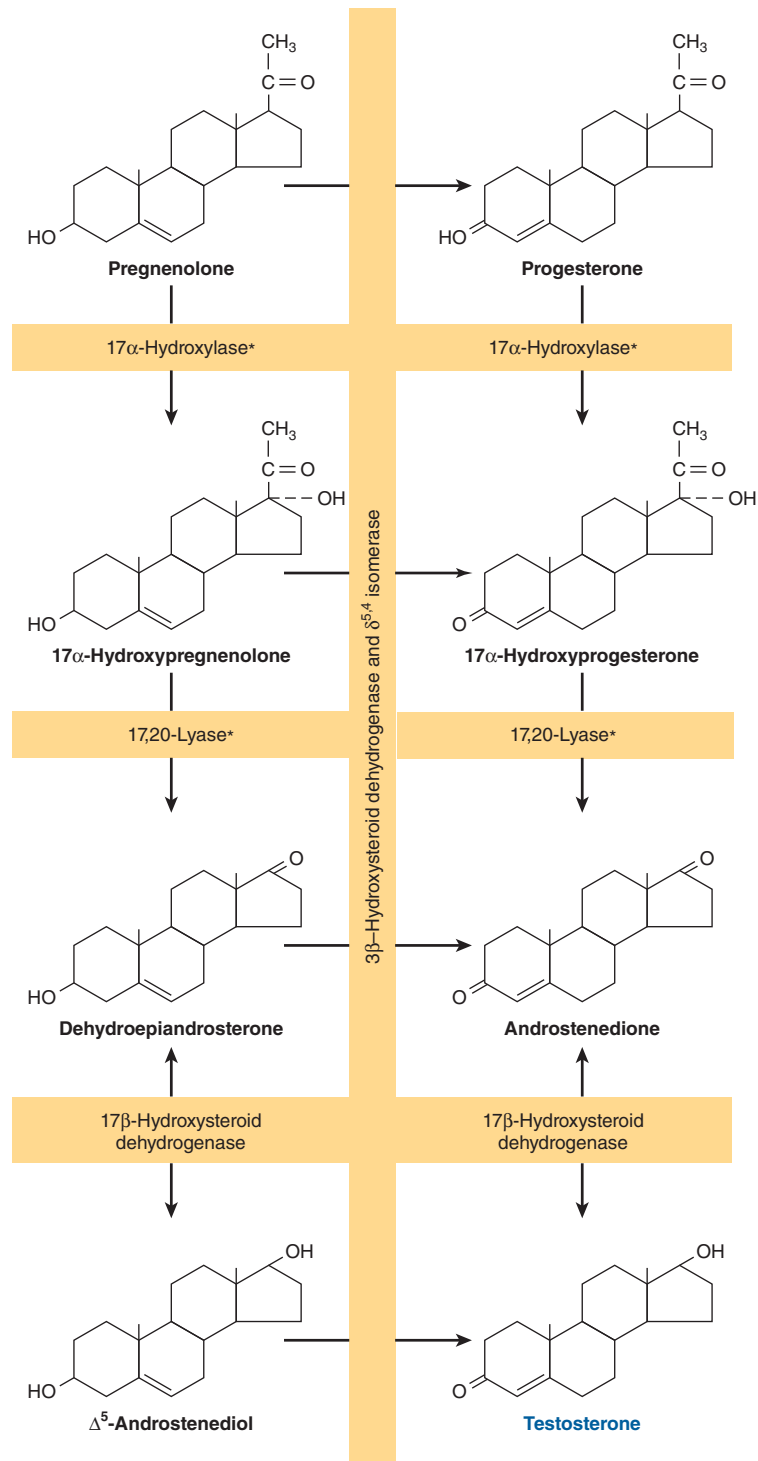

FIGURE 41-5 Pathways of testosterone biosynthesis. The pathway on the left side of the figure is called the Δ^5 or dehydroepiandrosterone pathway; the pathway on the right side is called the Δ^4 or progesterone pathway. The asterisk indicates that the 17 α -hydroxylase and 17,20-lyase activities reside in a single protein, P450c17.

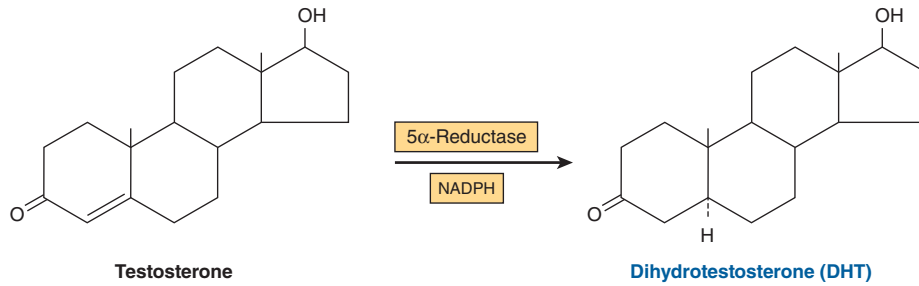

FIGURE 41-6 Dihydrotestosterone is formed from testosterone through action of the enzyme 5 α -reductase.

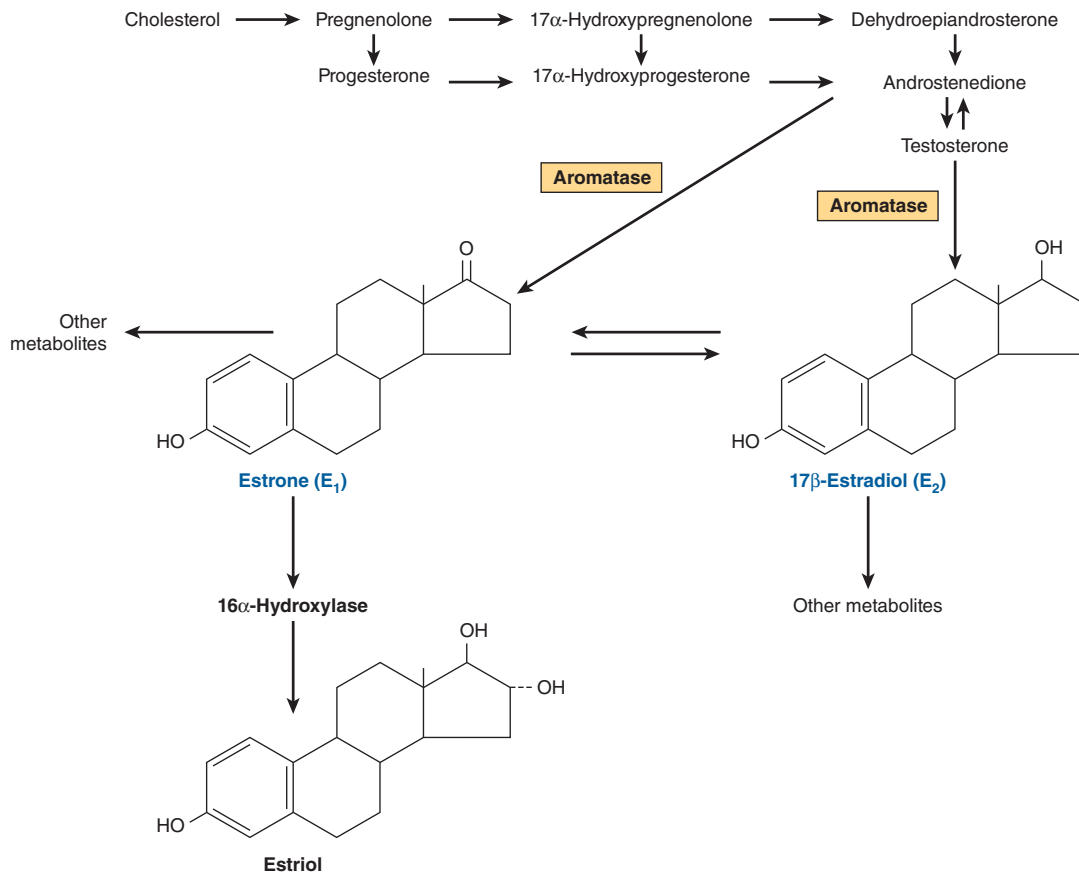

FIGURE 41-7 Biosynthesis of estrogens. (Slightly modified and reproduced, with permission, from Ganong WF: *Review of Medical Physiology*, 21st ed. McGraw-Hill, 2005.)

(E₂) accounts for 80% of the production of the latter. In females, adrenal androgens are important substrates since as much as 50% of the E₂ produced during pregnancy comes from the aromatization of androgens. Finally, conversion of androstenedione to estrone is the major source of estrogens in postmenopausal women. Aromatase activity is present in adipose cells and also in liver, skin, and other tissues. Increased activity of this enzyme may contribute to the “estrogenization” that characterizes such diseases as cirrhosis of the liver, hyperthyroidism, aging, and obesity. Aromatase inhibitors show promise as therapeutic agents in

breast cancer and possibly in other female reproductive tract malignancies.

1,25(OH)₂-D₃ (Calcitriol) Is Synthesized from a Cholesterol Derivative

1,25(OH)₂-D₃ is produced by a complex series of enzymatic reactions that involve the plasma transport of precursor molecules to a number of different tissues (Figure 41-9). One of these precursors is vitamin D—really not a vitamin, but this common name persists. The active molecule, 1,25(OH)₂-D₃, is transported to other organs where it activates biologic

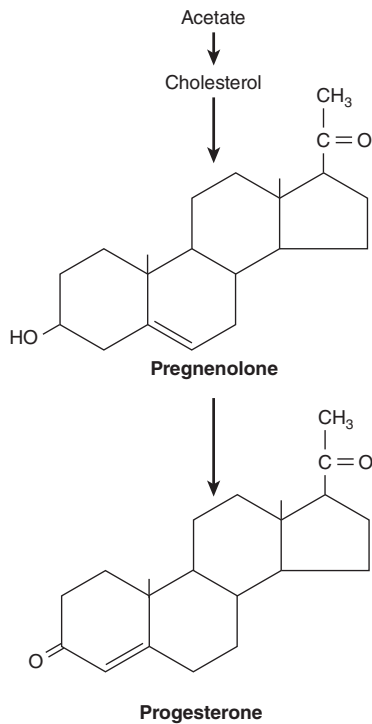

FIGURE 41-8 Biosynthesis of progesterone in the corpus luteum.

processes in a manner similar to that employed by the steroid hormones.

Skin

Small amounts of the precursor for $1,25(\text{OH})_2\text{-D}_3$ synthesis are present in food (fish liver oil, and egg yolk), but most of the precursor for $1,25(\text{OH})_2\text{-D}_3$ synthesis is produced in the malpighian layer of the epidermis from 7-dehydrocholesterol in an ultraviolet light-mediated, nonenzymatic **photolysis** reaction. The extent of this conversion is related directly to the intensity of the exposure and inversely to the extent of pigmentation in the skin. There is an age-related loss of 7-dehydrocholesterol in the epidermis that may be related to the negative calcium balance associated with old age.

Liver

A specific transport protein called the **vitamin D-binding protein** binds vitamin D_3 and its metabolites and moves vitamin D_3 from the skin or intestine to the liver, where it undergoes 25-hydroxylation, the first obligatory reaction in the production of $1,25(\text{OH})_2\text{-D}_3$. 25-Hydroxylation occurs in the endoplasmic reticulum in a reaction that requires magnesium, NADPH, molecular oxygen, and an uncharacterized

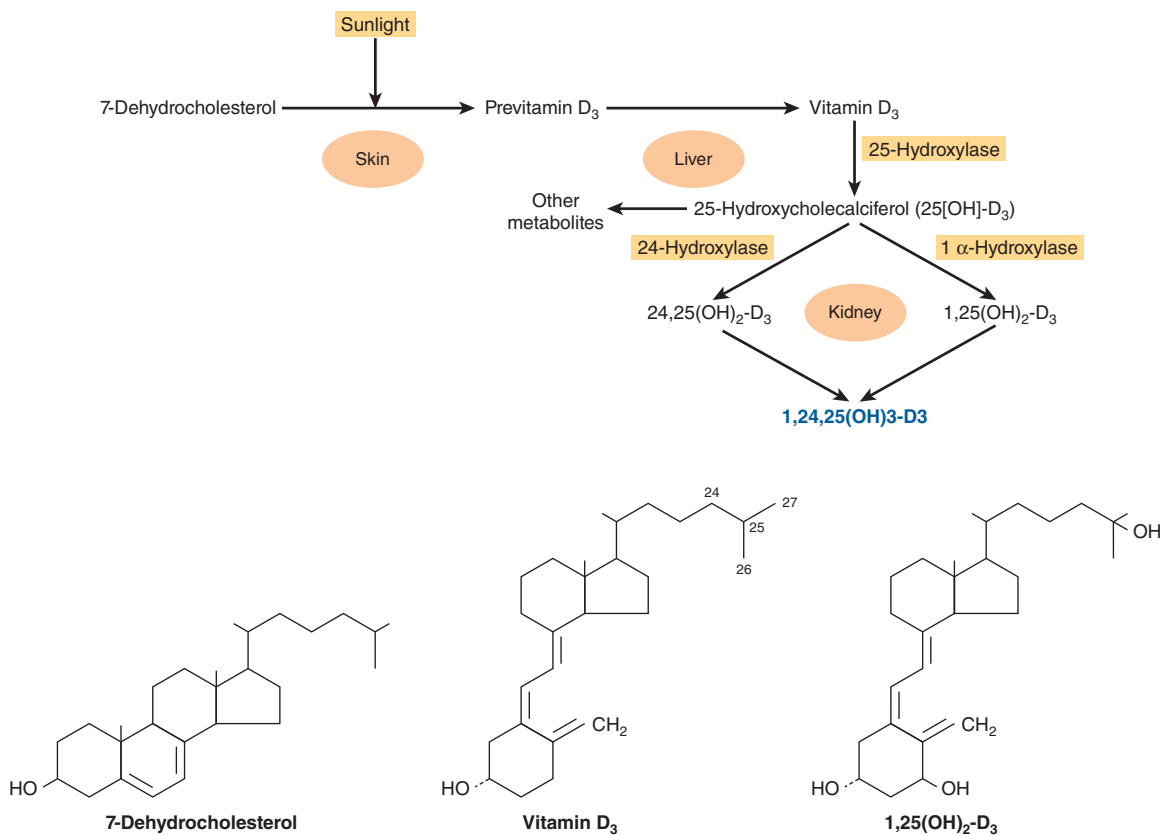

FIGURE 41-9 Formation and hydroxylation of vitamin D_3 . 25-Hydroxylation takes place in the liver, and the other hydroxylations occur in the kidneys. $25,26(\text{OH})_2\text{-D}_3$ and $1,25,26(\text{OH})_3\text{-D}_3$ are probably formed as well. The structures of 7-dehydrocholesterol, vitamin D_3 , and $1,25(\text{OH})_2\text{-D}_3$ are also shown. (Modified and reproduced, with permission, from Ganong WF: *Review of Medical Physiology*, 21st ed. McGraw-Hill, 2005.)

cytoplasmic factor. Two enzymes are involved: an NADPH-dependent cytochrome P450 reductase and a cytochrome P450. This reaction is not regulated, and it also occurs with low efficiency in kidney and intestine. The $25(\text{OH})_2\text{-D}_3$ enters the circulation, where it is the major form of vitamin D found in plasma, and is transported to the kidney by the vitamin D-binding protein.

Kidney

$25(\text{OH})_2\text{-D}_3$ is a weak agonist and must be modified by hydroxylation at position C_1 for full biologic activity. This is accomplished in mitochondria of the renal proximal convoluted tubule by a three-component monooxygenase reaction that requires NADPH, Mg^{2+} , molecular oxygen, and at least three enzymes: (1) a flavoprotein, renal ferredoxin reductase; (2) an iron sulfur protein, renal ferredoxin; and (3) cytochrome P450. This system produces $1,25(\text{OH})_2\text{-D}_3$, which is the most potent naturally occurring metabolite of vitamin D.

CATECHOLAMINES & THYROID HORMONES ARE MADE FROM TYROSINE

Catecholamines Are Synthesized in Final Form & Stored in Secretion Granules

Three amines—dopamine, norepinephrine, and epinephrine—are synthesized from tyrosine in the chromaffin cells of the adrenal medulla. The major product of the adrenal medulla is epinephrine. This compound constitutes about 80% of the catecholamines in the medulla, and it is not made in extramedullary tissue. In contrast, most of the norepinephrine present in organs innervated by sympathetic nerves is made in situ (about 80% of the total), and most of the rest is made in other nerve endings and reaches the target sites via the circulation. Epinephrine and norepinephrine may be produced and stored in different cells in the adrenal medulla and other chromaffin tissues.

The conversion of tyrosine to epinephrine requires four sequential steps: (1) ring hydroxylation; (2) decarboxylation; (3) side-chain hydroxylation to form norepinephrine; and (4) *N*-methylation to form epinephrine. The biosynthetic pathway and the enzymes involved are illustrated in Figure 41-10.

Tyrosine Hydroxylase Is Rate-Limiting for Catecholamine Biosynthesis

Tyrosine is the immediate precursor of catecholamines, and **tyrosine hydroxylase** is the rate-limiting enzyme in catecholamine biosynthesis. Tyrosine hydroxylase is found in both soluble and particle-bound forms only in tissues that synthesize catecholamines; it functions as an oxidoreductase, with tetrahydropteridine as a cofactor, to convert L-tyrosine to L-dihydroxyphenylalanine (**L-dopa**). As the rate-limiting

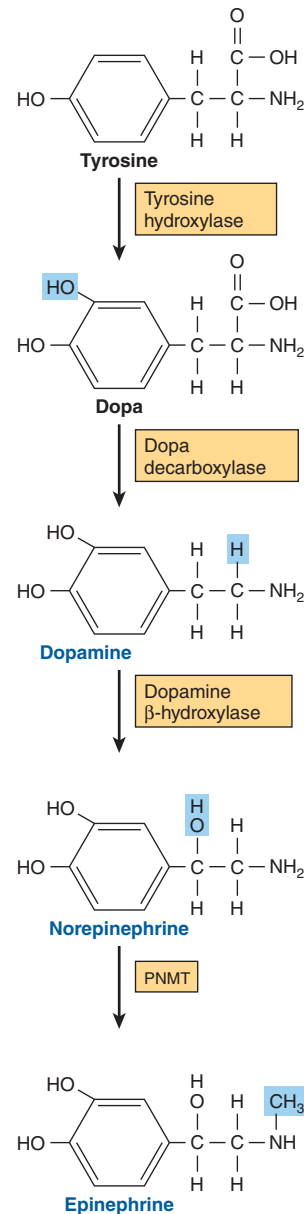

FIGURE 41-10 Biosynthesis of catecholamines. (PNMT, phenylethanolamine-*N*-methyltransferase.)

enzyme, tyrosine hydroxylase is regulated in a variety of ways. The most important mechanism involves feedback inhibition by the catecholamines, which compete with the enzyme for the pteridine cofactor. Catecholamines cannot cross the blood-brain barrier; hence, in the brain they must be synthesized locally. In certain central nervous system diseases (eg, Parkinson disease), there is a local deficiency of dopamine synthesis. L-Dopa, the precursor of dopamine, readily crosses the blood-brain barrier and so is an important agent in the treatment of Parkinson disease.

Dopa Decarboxylase Is Present in All Tissues

This soluble enzyme requires pyridoxal phosphate for the conversion of L-dopa to 3,4-dihydroxyphenylethylamine (**dopamine**).

Compounds that resemble L-dopa, such as α -methyldopa, are competitive inhibitors of this reaction. α -Methyldopa is effective in treating some kinds of hypertension.

Dopamine β -Hydroxylase (DBH) Catalyzes the Conversion of Dopamine to Norepinephrine

DBH is a monooxygenase and uses ascorbate as an electron donor, copper at the active site, and fumarate as modulator. DBH is in the particulate fraction of the medullary cells, probably in the secretion granule; thus, the conversion of dopamine to **norepinephrine** occurs in this organelle.

Phenylethanolamine-N-Methyltransferase (PNMT) Catalyzes the Production of Epinephrine

PNMT catalyzes the *N*-methylation of norepinephrine to form **epinephrine** in the epinephrine-forming cells of the adrenal medulla. Since PNMT is soluble, it is assumed that norepinephrine-to-epinephrine conversion occurs in the cytoplasm. The synthesis of PNMT is induced by glucocorticoid hormones that reach the medulla via the intra-adrenal portal system. This special system provides for a 100-fold steroid concentration gradient over systemic arterial blood, and this high intra-adrenal concentration appears to be necessary for the induction of PNMT.

T₃ & T₄ Illustrate the Diversity in Hormone Synthesis

The formation of **triiodothyronine (T₃)** and **tetraiodothyronine (thyroxine; T₄)** (see Figure 41–2) illustrates many of the principles of diversity discussed in this chapter. These hormones require a rare element (iodine) for bioactivity; they are synthesized as part of a very large precursor molecule (thyroglobulin); they are stored in an intracellular reservoir (colloid); and there is peripheral conversion of T₄ to T₃, which is a much more active hormone.

The thyroid hormones T₃ and T₄ are unique in that iodine (as iodide) is an essential component of both. In most parts of the world, iodine is a scarce component of soil, and for that reason there is little in food. A complex mechanism has evolved to acquire and retain this crucial element and to convert it into a form suitable for incorporation into organic compounds. At the same time, the thyroid must synthesize thyronine from tyrosine, and this synthesis takes place in thyroglobulin (Figure 41–11).

Thyroglobulin is the precursor of T₄ and T₃. It is a large iodinated, glycosylated protein with a molecular mass of 660 kDa. Carbohydrate accounts for 8% to 10% of the weight of thyroglobulin and iodide for about 0.2% to 1%, depending upon the iodine content in the diet. Thyroglobulin is composed of two large subunits. It contains 115 tyrosine residues, each of which is a potential site of iodination. About 70% of the iodide in thyroglobulin exists in the inactive precursors, **monoiodotyrosine (MIT)** and **diiodotyrosine (DIT)**, while 30% is in the **iodothyro-**

nyl residues, T₄ and T₃. When iodine supplies are sufficient, the T₄:T₃ ratio is about 7:1. In **iodine deficiency**, this ratio decreases, as does the DIT:MIT ratio. Thyroglobulin, a large molecule of about 5000 amino acids, provides the conformation required for tyrosyl coupling and iodide organification necessary in the formation of the diaminoacid thyroid hormones. It is synthesized in the basal portion of the cell and moves to the lumen, where it is a storage form of T₃ and T₄ in the colloid; several weeks' supply of these hormones exist in the normal thyroid. Within minutes after stimulation of the thyroid by TSH, colloid reenters the cell and there is a marked increase of phagolysosome activity. Various acid proteases and peptidases hydrolyze the thyroglobulin into its constituent amino acids, including T₄ and T₃, which are discharged into the extracellular space (see Figure 41–11). Thyroglobulin is thus a very large prohormone.

Iodide Metabolism Involves Several Discrete Steps

The thyroid is able to concentrate I[−] against a strong electrochemical gradient. This is an energy-dependent process and is linked to the Na⁺-K⁺-ATPase-dependent thyroidal I[−] transporter. The ratio of iodide in thyroid to iodide in serum (T:S ratio) is a reflection of the activity of this transporter. This activity is primarily controlled by TSH and ranges from 500:1 in animals chronically stimulated with TSH to 5:1 or less in hypophysectomized animals (no TSH). The T:S ratio in humans on a normal iodine diet is about 25:1.

The thyroid is the only tissue that can oxidize I[−] to a higher valence state, an obligatory step in I[−] organification and thyroid hormone biosynthesis. This step involves a heme-containing peroxidase and occurs at the luminal surface of the follicular cell. Thyroperoxidase, a tetrameric protein with a molecular mass of 60 kDa, requires hydrogen peroxide (H₂O₂) as an oxidizing agent. The H₂O₂ is produced by an NADPH-dependent enzyme resembling cytochrome *c* reductase. A number of compounds inhibit I[−] oxidation and therefore its subsequent incorporation into MIT and DIT. The most important of these are the thiourea drugs. They are used as antithyroid drugs because of their ability to inhibit thyroid hormone biosynthesis at this step. Once iodination occurs, the iodine does not readily leave the thyroid. Free tyrosine can be iodinated, but it is not incorporated into proteins since no tRNA recognizes iodinated tyrosine.

The coupling of two DIT molecules to form T₄—or of an MIT and DIT to form T₃—occurs within the thyroglobulin molecule. A separate coupling enzyme has not been found, and since this is an oxidative process it is assumed that the same thyroperoxidase catalyzes this reaction by stimulating free radical formation of iodotyrosine. This hypothesis is supported by the observation that the same drugs which inhibit I[−] oxidation also inhibit coupling. The formed thyroid hormones remain as integral parts of thyroglobulin until the latter is degraded, as described above.

A deiodinase removes I[−] from the inactive mono and diiodothyronine molecules in the thyroid. This mechanism

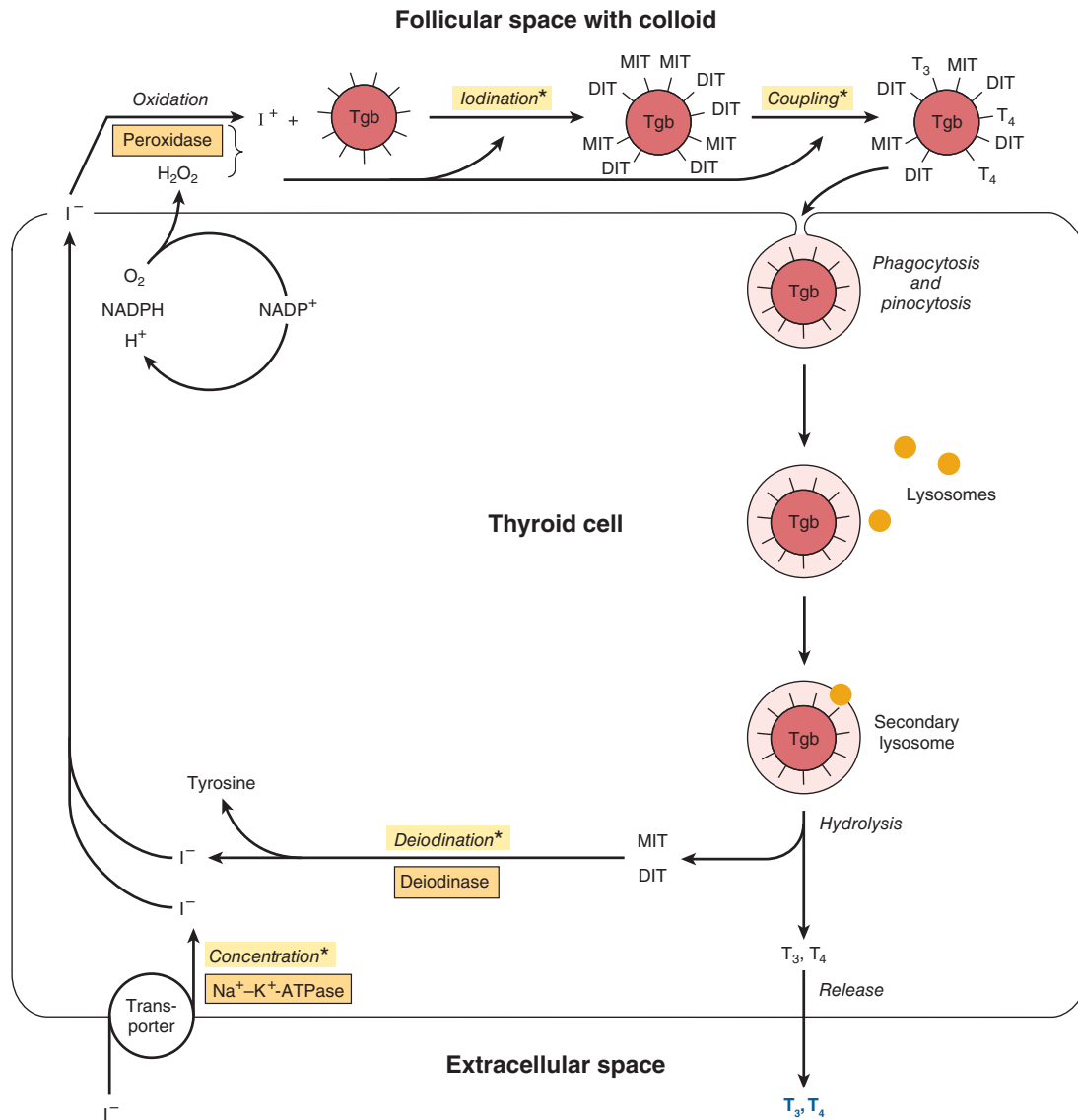

FIGURE 41-11 Model of iodide metabolism in the thyroid follicle. A follicular cell is shown facing the follicular lumen (top) and the extracellular space (bottom). Iodide enters the thyroid primarily through a transporter (bottom left). Thyroid hormone synthesis occurs in the follicular space through a series of reactions, many of which are peroxidase-mediated. Thyroid hormones, stored in the colloid in the follicular space, are released from thyroglobulin by hydrolysis inside the thyroid cell. (DIT, diiodotyrosine; MIT, monoiodotyrosine; Tgb, thyroglobulin; T_3 , triiodothyronine; T_4 , tetraiodothyronine; T_3 and T_4 structures are shown in Figure 41-2B.) Asterisks indicate steps or processes where inherited enzyme deficiencies cause congenital goiter and often result in hypothyroidism.

provides a substantial amount of the I^- used in T_3 and T_4 biosynthesis. A peripheral deiodinase in target tissues such as pituitary, kidney, and liver selectively removes I^- from the 5' position of T_4 to make T_3 (see Figure 41-2), which is a much more active molecule. In this sense, T_4 can be thought of as a prohormone, though it does have some intrinsic activity.

Several Hormones Are Made From Larger Peptide Precursors

Formation of the critical disulfide bridges in insulin requires that this hormone be first synthesized as part of a larger

precursor molecule, proinsulin. This is conceptually similar to the example of the thyroid hormones, which can only be formed in the context of a much larger molecule. Several other hormones are synthesized as parts of large precursor molecules, not because of some special structural requirement but rather as a mechanism for controlling the available amount of the active hormone. PTH and angiotensin II are examples of this type of regulation. Another interesting example is the POMC protein, which can be processed into many different hormones in a tissue-specific manner. These examples are discussed in detail below.

Insulin Is Synthesized as a Preprohormone & Modified Within the β Cell

Insulin has an AB heterodimeric structure with one intra-chain (A6–A11) and two interchain disulfide bridges (A7–B7 and A20–B19) (**Figure 41–12**). The A and B chains could be synthesized in the laboratory, but attempts at a biochemical synthesis of the mature insulin molecule yielded very poor results. The reason for this became apparent when it was discovered that insulin is synthesized as a **preprohormone** (molecular weight ~11,500), which is the prototype for peptides that are processed from larger precursor molecules. The hydrophobic 23-amino-acid pre-, or leader, sequence directs the molecule into the cisternae of the endoplasmic reticulum and then is removed. This results in the 9000-MW proinsulin molecule, which provides the conformation necessary for the proper and efficient formation of the disulfide bridges. As shown in Figure 41–12, the sequence of proinsulin, starting from the amino terminus, is B chain—connecting (C) peptide—A chain. The proinsulin molecule undergoes a series of site-specific peptide cleavages that result in the formation of equimolar amounts of mature insulin and C-peptide. These enzymatic cleavages are summarized in Figure 41–12.

PTH Is Secreted as an 84-Amino-Acid Peptide

The immediate precursor of PTH is **proPTH**, which differs from the native 84-amino-acid hormone by having a highly

basic hexapeptide amino terminal extension. The primary gene product and the immediate precursor for proPTH is the 115-amino-acid **preproPTH**. This differs from proPTH by having an additional 25-amino acid NH_2 -terminal extension that in common with the other leader or signal sequences characteristic of secreted proteins is predominantly hydrophobic in nature. The complete structure of preproPTH and the sequences of proPTH and PTH are illustrated in **Figure 41–13**. PTH_{1-34} has full biologic activity, and the region 25 to 34 is primarily responsible for receptor binding.

The biosynthesis of PTH and its subsequent secretion are regulated by the plasma ionized calcium (Ca^{2+}) concentration through a complex process. An acute decrease of Ca^{2+} results in a marked increase of PTH mRNA, and this is followed by an increased rate of PTH synthesis and secretion. However, about 80% to 90% of the proPTH synthesized cannot be accounted for as intact PTH in cells or in the incubation medium of experimental systems. This finding led to the conclusion that most of the proPTH synthesized is quickly degraded. It was later discovered that this rate of degradation decreases when Ca^{2+} concentrations are low, and it increases when Ca^{2+} concentrations are high. A Ca^{2+} receptor on the surface of the parathyroid cell mediates these effects. Very specific fragments of PTH are generated during its proteolytic digestion (**Figure 41–13**). A number of proteolytic enzymes, including cathepsins B and D, have been identified in parathyroid tissue. Cathepsin B cleaves PTH into two fragments: PTH_{1-36} and

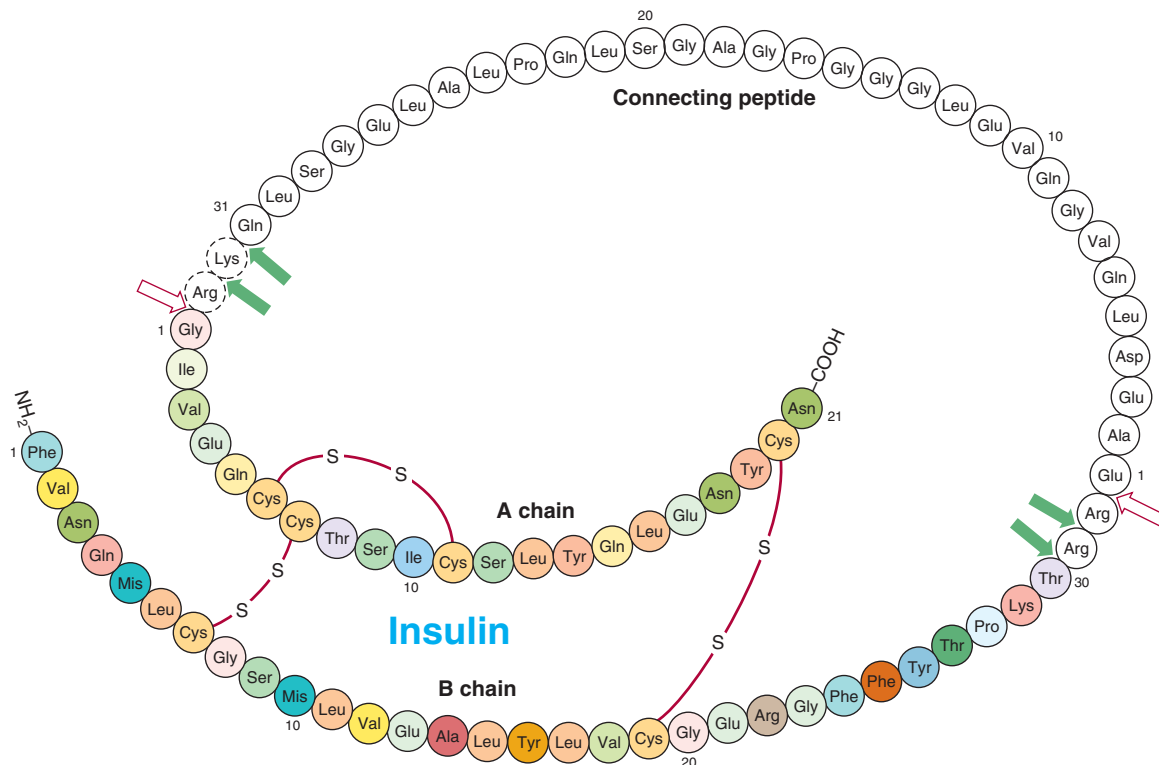

FIGURE 41–12 Structure of human proinsulin. Insulin and C-peptide molecules are connected at two sites by peptide bonds. An initial cleavage by a trypsin-like enzyme (open arrows) followed by several cleavages by a carboxypeptidase-like enzyme (solid arrows) results in the production of the heterodimeric (AB) insulin molecule (colored) and the C-peptide (white).

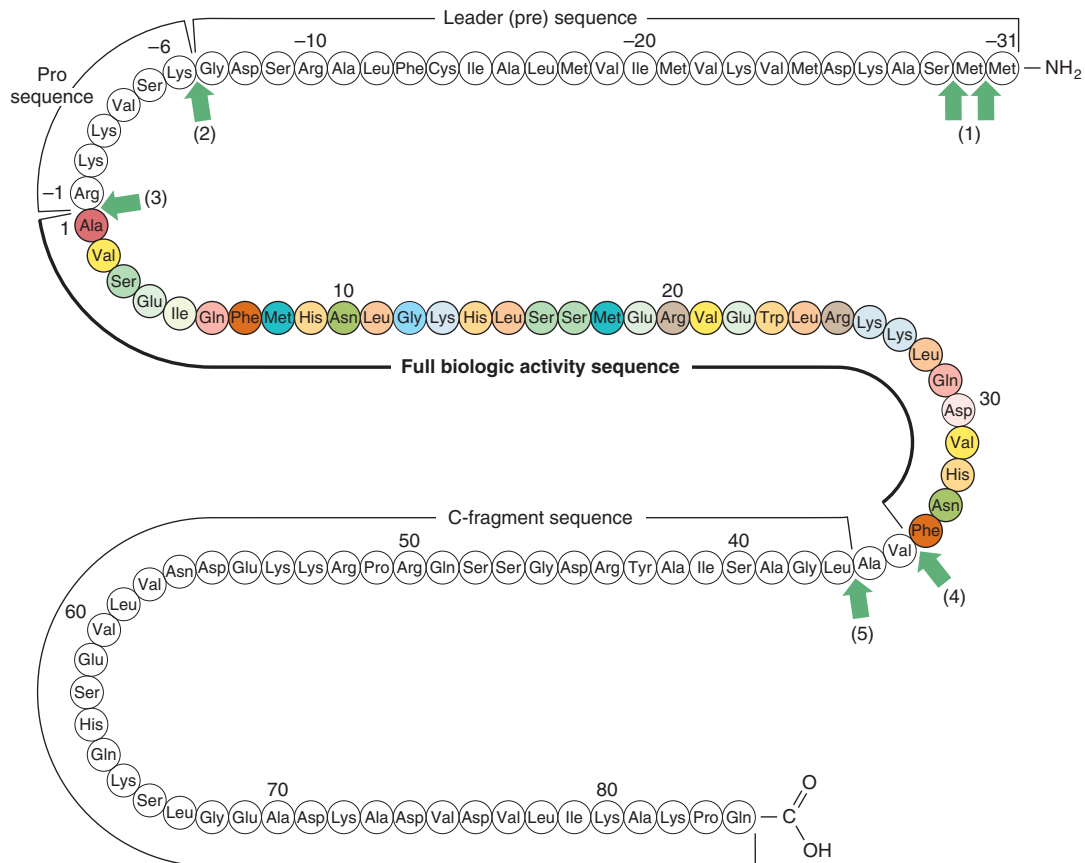

FIGURE 41-13 Structure of bovine preproparathyroid hormone. The green arrows indicate sites cleaved by processing enzymes in the parathyroid gland and in the liver after secretion of the hormone (1-5). The biologically active region of the molecule (colored) is flanked by sequence not required for activity on target receptors. (Slightly modified and reproduced, with permission, from Habener JF: Recent advances in parathyroid hormone research. Clin Biochem 1981;14:223. Copyright © 1981. Reprinted with permission from Elsevier.)

PTH_{37-84} . PTH_{37-84} is not further degraded; however, PTH_{1-36} is rapidly and progressively cleaved into di- and tripeptides. Most of the proteolysis of PTH occurs within the gland, but a number of studies confirm that PTH, once secreted, is proteolytically degraded in other tissues, especially the liver, by similar mechanisms.

Angiotensin II Is Also Synthesized From a Large Precursor

The renin-angiotensin system is involved in the regulation of blood pressure and electrolyte metabolism (through production of aldosterone). The primary hormone involved in these processes is angiotensin II, an octapeptide made from angiotensinogen (**Figure 41-14**). Angiotensinogen, a large α_2 -globulin made in liver, is the substrate for renin, an enzyme produced in the juxtaglomerular cells of the renal afferent arteriole. The position of these cells makes them particularly sensitive to blood pressure changes, and many of the physiologic regulators of renin release act through renal baroreceptors. The juxtaglomerular cells are also sensitive to changes of

Na^+ and Cl^- concentration in the renal tubular fluid; therefore, any combination of factors that decreases fluid volume (dehydration, decreased blood pressure, fluid, or blood loss) or decreases NaCl concentration stimulates renin release. Renal sympathetic nerves that terminate in the juxtaglomerular cells mediate the central nervous system and postural effects on renin release independently of the baroreceptor and salt effects, a mechanism that involves the β -adrenergic receptor. Renin acts upon the substrate angiotensinogen to produce the decapeptide angiotensin I.

Angiotensin-converting enzyme, a glycoprotein found in lung, endothelial cells, and plasma, removes two carboxyl terminal amino acids from the decapeptide angiotensin I to form angiotensin II in a step that is not thought to be rate limiting. Various nonapeptide analogs of angiotensin I and other compounds act as competitive inhibitors of converting enzyme and are used to treat renin-dependent hypertension. These are referred to as **angiotensin-converting enzyme (ACE) inhibitors**. Angiotensin II increases blood pressure by causing vasoconstriction of the arteriole and is a very potent vasoactive substance. It inhibits renin release from the juxtaglomerular

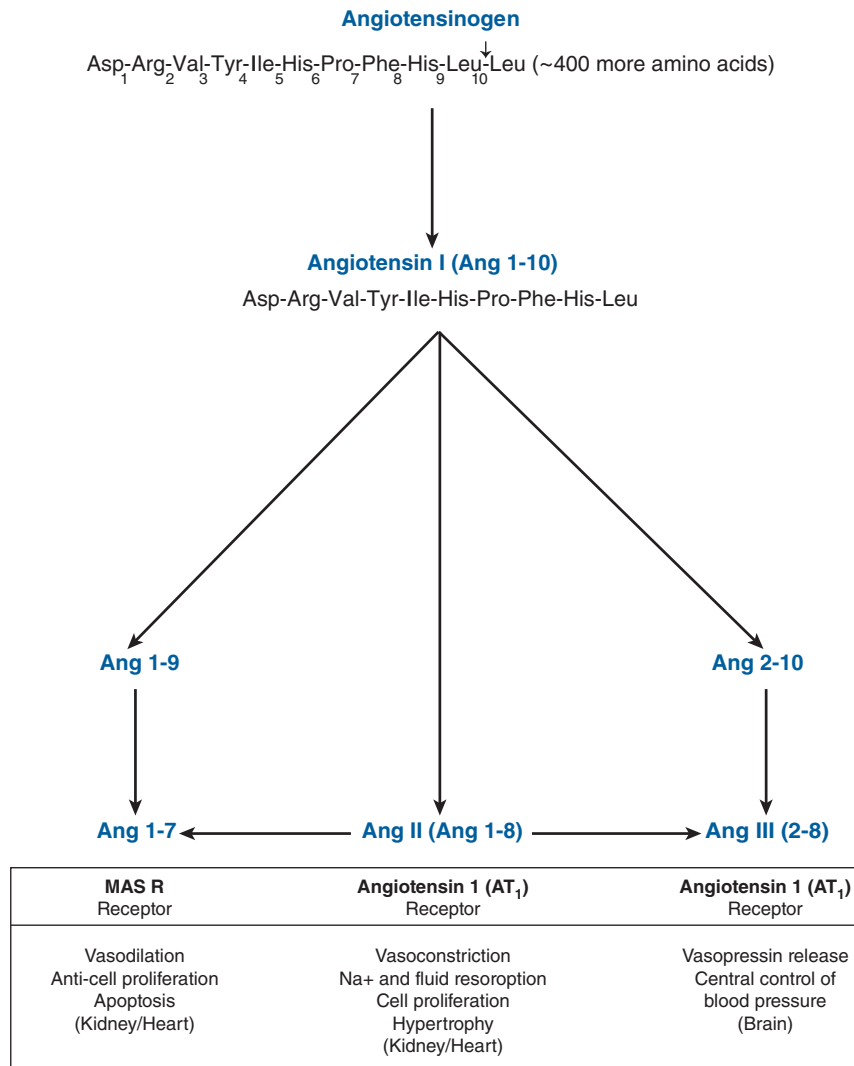

FIGURE 41-14 Formation, metabolism and selected physiological activities of angiotensins. The three most biologically active forms of angiotensin (Ang), Ang 1-7, Ang 1-8 (Ang II) and Ang 2-8 (Ang III) are shown. The numbers represent the amino acids present in each Ang are numbered relative to the sequence of Ang 1-10 (Ang I). All Ang forms are derived by proteolysis catalyzed by a number of different proteases. Initial processing of the 400⁺ amino acid long Angiotensinogen precursor is catalyzed by Renin, while several of the other proteolytic events are catalyzed by angiotensin converting enzyme 1 (ACE) 1, or ACE2. The receptors bound by the different Ang forms, as well as physiological outcomes of receptor binding are shown (**bottom**).

cells and is a potent stimulator of aldosterone production. This results in Na⁺ retention, volume expansion, and increased blood pressure.

In some species, angiotensin II is converted to the heptapeptide angiotensin III (Figure 41-14), an equally potent stimulator of aldosterone production. In humans, the plasma level of angiotensin II is four times greater than that of angiotensin III, so most effects are exerted by the octapeptide. Angiotensins II and III are rapidly inactivated by angiotensinases.

Angiotensin II binds to specific adrenal cortex glomerulosa cell receptors. The hormone-receptor interaction does not activate adenyl cyclase, and cAMP does not appear to mediate the action of this hormone. The actions of angiotensin II,

which are to stimulate the conversion of cholesterol to pregnenolone and of corticosterone to 18-hydroxycorticosterone and aldosterone, may involve changes in the concentration of intracellular calcium and of phospholipid metabolites by mechanisms similar to those described in Chapter 42.

Complex Processing Generates the Pro-Opiomelanocortin (POMC) Peptide Family

The POMC family consists of peptides that act as hormones (ACTH, LPH, MSH) and others that may serve as neurotransmitters or neuromodulators (endorphins) (Figure 41-15). POMC is synthesized as a precursor molecule of 285 amino

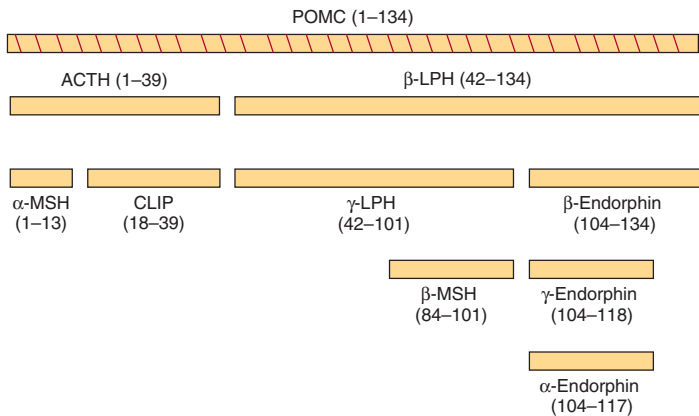

FIGURE 41-15 Products of pro-opiomelanocortin (POMC) cleavage. (CLIP, corticotropin-like intermediate lobe peptide; LPH, lipotropin; MSH, melanocyte-stimulating hormone.)

acids and is processed differently in various regions of the pituitary.

The POMC gene is expressed in the anterior and intermediate lobes of the pituitary. The most conserved sequences between species are within the amino terminal fragment, the ACTH region, and the β -endorphin region. POMC or related products are found in several other vertebrate tissues, including the brain, placenta, gastrointestinal tract, reproductive tract, lung, and lymphocytes.

The POMC protein is processed differently in the anterior lobe than in the intermediate lobe. The intermediate lobe of the pituitary is rudimentary in adult humans, but it is active in human fetuses and in pregnant women during late gestation and is also active in many animal species. Processing of the POMC protein in the peripheral tissues (gut, placenta, and male reproductive tract) resembles that in the intermediate lobe. There are three basic peptide groups: (1) ACTH, which can give rise to α -MSH and corticotropin-like intermediate lobe peptide (CLIP); (2) β -lipotropin (β -LPH), which can yield γ -LPH, β -MSH, and β -endorphin (and thus α - and γ -endorphins); and (3) a large amino terminal peptide, which generates γ -MSH (not shown). The diversity of these products is due to the many dibasic amino acid clusters that are potential cleavage sites for trypsin-like enzymes. Each of the peptides mentioned is preceded by Lys-Arg, Arg-Lys, Arg-Arg, or Lys-Lys residues. After the prohormone segment is cleaved, the next cleavage, in both anterior and intermediate lobes, is between ACTH and β -LPH, resulting in an amino terminal peptide with ACTH and a β -LPH segment (Figure 41-15). ACTH₁₋₃₉ is subsequently cleaved from the amino terminal peptide, and in the anterior lobe essentially no further cleavages occur. In the intermediate lobe, ACTH₁₋₃₉ is cleaved into α -MSH (residues 1-13) and CLIP (18-39); β -LPH (42-134) is converted to γ -LPH (42-101) and β -endorphin (104-134). β -MSH (84-101) is derived from γ -LPH, while γ -MSH (50-74) is derived from a POMC N-terminal fragment (1-74).

There are extensive additional tissue-specific modifications of these peptides that affect activity. These modifications include phosphorylation, acetylation, glycosylation, and amidation.

Mutations of the α -MSH receptor are linked to a common, early-onset form of obesity. This observation has redirected attention to the POMC peptide hormones.

THERE IS VARIATION IN THE STORAGE & SECRETION OF HORMONES

As mentioned above, the steroid hormones and $1,25(\text{OH})_2\text{-D}_3$ are synthesized in their final active form. They are also secreted as they are made, and thus there is no intracellular reservoir of these hormones. The catecholamines, also synthesized in active form, are stored in granules in the chromaffin cells in the adrenal medulla. In response to appropriate neural stimulation, these granules are released from the cell through exocytosis, and the catecholamines are released into the circulation. A several-hour reserve supply of catecholamines exists in the chromaffin cells.

PTH also exists in storage vesicles. As much as 80% to 90% of the pro PTH synthesized is degraded before it enters this final storage compartment, especially when Ca^{2+} levels are high in the parathyroid cell (see above). PTH is secreted when Ca^{2+} is low in the parathyroid cells, which contain a several-hour supply of the hormone.

The human pancreas secretes about 40 to 50 units of insulin daily; this represents about 15% to 20% of the hormone stored in the β cells. Insulin and the C-peptide (see Figure 41-12) are normally secreted in equimolar amounts. Stimuli such as glucose, which provokes insulin secretion, therefore trigger the processing of proinsulin to insulin as an essential part of the secretory response.

A several-week supply of T_3 and T_4 exists in the thyroglobulin that is stored in colloid in the lumen of the thyroid follicles. These hormones can be released upon stimulation by TSH. This is the most exaggerated example of a prohormone, as a molecule containing ~5000 amino acids must be first synthesized, then degraded, to supply a few molecules of the active hormones T_4 and T_3 .

The diversity in storage and secretion of hormones is illustrated in **Table 41-5**.

TABLE 41-5 Diversity in the Storage of Hormones

Hormone	Supply Stored in Cell
Steroids and $1,25(\text{OH})_2\text{-D}_3$	None
Catecholamines and PTH	Hours
Insulin	Days
T_3 and T_4	Weeks

SOME HORMONES HAVE PLASMA TRANSPORT PROTEINS

The class I hormones are hydrophobic in chemical nature and thus are not very soluble in plasma. These hormones, principally the steroids and thyroid hormones, have specialized plasma transport proteins that serve several purposes. First, these proteins circumvent the solubility problem and thereby deliver the hormone to the target cell. They also provide a circulating reservoir of the hormone that can be substantial, as in the case of the thyroid hormones. Hormones, when bound to the transport proteins, cannot be metabolized, thereby prolonging their plasma half-life ($t_{1/2}$). The binding affinity of a given hormone to its transporter determines the bound versus free ratio of the hormone. This is important because only the free form of a hormone is biologically active. In general, the concentration of free hormone in plasma is very low, in the range of 10^{-15} to 10^{-9} mol/L. It is important to distinguish between plasma transport proteins and hormone receptors. Both bind hormones but with very different characteristics (Table 41-6).

The hydrophilic hormones—generally class II and of peptide structure—are freely soluble in plasma and do not require transport proteins. Hormones such as insulin, growth hormone, ACTH, and TSH circulate in the free, active form and have very short plasma half-lives. A notable exception is IGF-I, which is transported bound to members of a family of binding proteins.

Thyroid Hormones Are Transported by Thyroid-Binding Globulin

Many of the principles discussed above are illustrated in a discussion of thyroid-binding proteins. One-half to two-thirds of T_4 and T_3 in the body is in an extrathyroidal reservoir. Most of this circulates in bound form, ie, bound to a specific binding protein, **thyroxine-binding globulin (TBG)**. TBG, a glycoprotein with a molecular mass of 50 kDa, binds T_4 and T_3 and has the capacity to bind 20 $\mu\text{g}/\text{dL}$ of plasma. Under normal circumstances, TBG binds—noncovalently—nearly all of the T_4 and T_3 in plasma, and it binds T_4 with greater affinity

TABLE 41-6 Comparison of Receptors With Transport Proteins

Feature	Receptors	Transport Proteins
Concentration	Very low (thousands/cell)	Very high (billions/ μL)
Binding affinity (K_d)	High (pmol/L to nmol/L range)	Low ($\mu\text{mol}/\text{L}$ range)
Binding specificity	Very high	Low
Saturability	Yes	No
Reversibility	Yes	Yes
Signal transduction	Yes	No

TABLE 41-7 Comparison of T_4 and T_3 in Plasma

Total Hormone ($\mu\text{g}/\text{dL}$)	Percentage of Total	Free Hormone			$t_{1/2}$ in Blood (days)
		ng/dL	Molarity		
T_4	8	0.03	~ 2.24	3.0×10^{-11}	6.5
T_3	0.15	0.3	~ 0.4	0.6×10^{-11}	1.5

than T_3 (Table 41-7). The plasma half-life of T_4 is correspondingly four to five times that of T_3 . The small, unbound (free) fraction is responsible for the biologic activity. Thus, in spite of the great difference in total amount, the free fraction of T_3 approximates that of T_4 , and given that T_3 is intrinsically more active than T_4 , most biologic activity is attributed to T_3 . TBG does not bind any other hormones.

Glucocorticoids Are Transported by Corticosteroid-Binding Globulin

Hydrocortisone (cortisol) also circulates in plasma in protein-bound and free forms. The main plasma binding protein is an α -globulin called **transcortin**, or **corticosteroid-binding globulin (CBG)**. CBG is produced in the liver, and its synthesis, like that of TBG, is increased by estrogens. CBG binds most of the hormone when plasma cortisol levels are within the normal range; much smaller amounts of cortisol are bound to albumin. The avidity of binding helps determine the biologic half-lives of various glucocorticoids. Cortisol binds tightly to CBG and has a $t_{1/2}$ of 1.5 to 2 hours, while corticosterone, which binds less tightly, has a $t_{1/2}$ of <1 hour (Table 41-8). The unbound (free) cortisol constitutes $\sim 8\%$ of the total and represents the biologically active fraction. Binding to CBG is not restricted to glucocorticoids. Deoxycorticosterone and progesterone interact with CBG with sufficient affinity to compete for cortisol binding. Aldosterone, the most potent natural mineralocorticoid, does not have a specific plasma transport protein. Gonadal steroids bind very weakly to CBG (Table 41-8).

TABLE 41-8 Approximate Affinities of Steroids for Serum-Binding Proteins

	SHBG ^a	CBG ^a
Dihydrotestosterone	1	>100
Testosterone	2	>100
Estradiol	5	>10
Estrone	>10	>100
Progesterone	>100	~ 2
Cortisol	>100	~ 3
Corticosterone	>100	~ 5

^aAffinity expressed as K_d (nmol/L).

Gonadal Steroids Are Transported by Sex-Hormone-Binding Globulin

Most mammals, humans included, have a plasma β -globulin that binds testosterone with specificity, relatively high affinity, and limited capacity (Table 41–8). This protein, usually called **sex-hormone-binding globulin (SHBG)** or testosterone-estrogen-binding globulin (TEBG), is produced in the liver. Its production is increased by estrogens (women have twice the serum concentration of SHBG as men), certain types of liver disease, and hyperthyroidism; it is decreased by androgens, advancing age, and hypothyroidism. Many of these conditions also affect the production of CBG and TBG. Since SHBG and albumin bind 97% to 99% of circulating testosterone, only a small fraction of the hormone in circulation is in the free (biologically active) form. The primary function of SHBG may be to restrict the free concentration of testosterone in the serum. Testosterone binds to SHBG with higher affinity than does estradiol (Table 41–8). Therefore, a change in the level of SHBG causes a greater change in the free testosterone level than in the free estradiol level.

Estrogens are bound to SHBG and progestins to CBG. SHBG binds estradiol about five times less avidly than it binds testosterone or DHT, while progesterone and cortisol have little affinity for this protein (Table 41–8). In contrast, progesterone and cortisol bind with nearly equal affinity to CBG, which in turn has little avidity for estradiol and even less for testosterone, DHT, or estrone.

These binding proteins also provide a circulating reservoir of hormone, and because of the relatively large binding capacity they probably buffer against sudden changes in the plasma level. Because the metabolic clearance rates of these steroids are inversely related to the affinity of their binding to SHBG, estrone is cleared more rapidly than estradiol, which in turn is cleared more rapidly than testosterone or DHT.

SUMMARY

- The presence of a specific receptor defines the target cells for a given hormone.
- Receptors are proteins that bind specific hormones and generate an intracellular signal (receptor-effector coupling).
- Some hormones have intracellular receptors; others bind to receptors on the plasma membrane.
- Hormones are synthesized from a number of precursor molecules, including cholesterol, tyrosine per se, and all the constituent amino acids of peptides and proteins.
- A number of modification processes alter the activity of hormones. For example, many hormones are synthesized from larger precursor molecules.
- The complement of enzymes in a particular cell type allows for the production of a specific class of steroid hormone.
- Most of the lipid-soluble hormones are bound to rather specific plasma transport proteins.

REFERENCES

- Bain DL, Heneghan AF, Connaghan-Jones KD, et al: Nuclear receptor structure: implications for function. *Ann Rev Physiol* 2007;69:201.
- Bartalina L: Thyroid hormone-binding proteins: update 1994. *Endocr Rev* 1994;13:140.
- Cheung E, Kraus WL: Genomic analyses of hormone signaling and gene regulation. *Annu Rev Physiol* 2010;72:191–218.
- Cho YM, Fujita Y, Kieffer TJ: Glucagon-like peptide-1: glucose homeostasis and beyond. *Annu Rev Physiol* 2014;76:535–559.
- Cristina Casals-Casas C, Desvergne B: Endocrine disruptors: from endocrine to metabolic disruption. *Annu Rev Physiol* 2011;73:23.135–162.
- Dai G, Carrasco L, Carrasco N: Cloning and characterization of the thyroid iodide transporter. *Nature* 1996;379:458.
- DeLuca HR: The vitamin D story: a collaborative effort of basic science and clinical medicine. *FASEB J* 1988;2:224.
- Douglass J, Civelli O, Herbert E: Polyprotein gene expression: generation of diversity of neuroendocrine peptides. *Annu Rev Biochem* 1984;53:665.
- Farooqi IS, O’Rahilly S: Monogenic obesity in humans. *Ann Rev Med* 2005;56:443.
- Fan W, Atkins AR, Yu RT, et al: Road to exercise mimetics: targeting nuclear receptor in skeletal muscle. *J Mol Endocrinol* 2013;51:T87–T100.
- Mazziotti G, Giustina A: Glucocorticoids and the regulation of growth hormone secretion. *Nat Rev Endocrinol* 2013;9:265–276.
- Miller WL: Molecular biology of steroid hormone biosynthesis. *Endocr Rev* 1988;9:295.
- Nagatsu T: Genes for human catecholamine-synthesizing enzymes. *Neurosci Res* 1991;12:315.
- Russell DW, Wilson JD: Steroid 5 alpha-reductase: two genes/two enzymes. *Annu Rev Biochem* 1994;63:25.
- Russell J, Bar A, Sherwood LM, et al: Interaction between calcium and 1,25-dihydroxyvitamin D₃ in the regulation of preproparathyroid hormone and vitamin D₃ receptor mRNA in avian parathyroids. *Endocrinology* 1993;132:2639.
- Steiner DF, Smeekens SP, Ohagi S, et al: The new enzymology of precursor processing endoproteases. *J Biol Chem* 1992;267:23435.
- Taguchi A, White M: Insulin-like signaling, nutrient homeostasis, and life span. *Ann Rev Physiol* 2008;70:191.

Hormone Action & Signal Transduction

P. Anthony Weil, PhD

OBJECTIVES

After studying this chapter, you should be able to:

- Explain the roles of stimulus, hormone release, signal generation, and effector response in a variety of hormone-regulated physiological processes.
- Explain the role of receptors and GTP-binding G proteins in hormone signal transduction, particularly with regard to the generation of second messengers.
- Appreciate the complex patterns of signal transduction pathway cross-talk in mediating complicated physiological outputs.
- Understand the key roles that protein-ligand, protein-protein, protein posttranslational modification (eg, phosphorylation and acetylation), and protein-DNA interactions play in mediating hormone-directed physiological processes.
- Appreciate that hormone-modulated receptors, second messengers, and associated signaling molecules represent a rich source of potential drug target development given their key roles in the regulation of physiology.

BIOMEDICAL IMPORTANCE

The homeostatic adaptations an organism makes to a constantly changing environment are in large part accomplished through alterations of the activity and amount of proteins. Hormones provide a major means of facilitating these changes. A hormone-receptor interaction results in generation of an intracellular signal that can either regulate the activity of a select set of genes, thereby altering the amount of certain proteins in the target cell, or affect the activity of specific proteins, including enzymes and transporter or channel proteins. The signal can influence the location of proteins in the cell and can affect general processes such as protein synthesis, cell growth, and replication, often through effects on gene expression. Other signaling molecules—including cytokines, interleukins, growth factors, and metabolites—use some of the same general mechanisms and signal transduction pathways. Excessive, deficient, or inappropriate production and release of hormones and of these other regulatory molecules are major causes of disease. Many pharmacotherapeutic agents are aimed at correcting or otherwise influencing the pathways discussed in this chapter.

HORMONES TRANSDUCE SIGNALS TO AFFECT HOMEOSTATIC MECHANISMS

The general steps involved in producing a coordinated response to a particular stimulus are illustrated in **Figure 42–1**. The stimulus can be a challenge or a threat to the organism, to an organ, or to the integrity of a single cell within that organism. Recognition of the stimulus is the first step in the adaptive response. At the organismic level, this generally involves the nervous system and the special senses (sight, hearing, pain, smell, and touch). At the organ, tissue, or cellular level, recognition involves physicochemical factors such as pH, O₂ tension, temperature, nutrient supply, noxious metabolites, and osmolarity. Appropriate recognition results in the release of one or more hormones that will govern generation of the necessary adaptive response. For purposes of this discussion, the hormones are categorized as described in Table 41–4, that is, based on the location of their specific cellular receptors and the type of signals generated. Group I hormones interact with an intracellular receptor and group II hormones with receptor recognition sites located on the extracellular surface of the

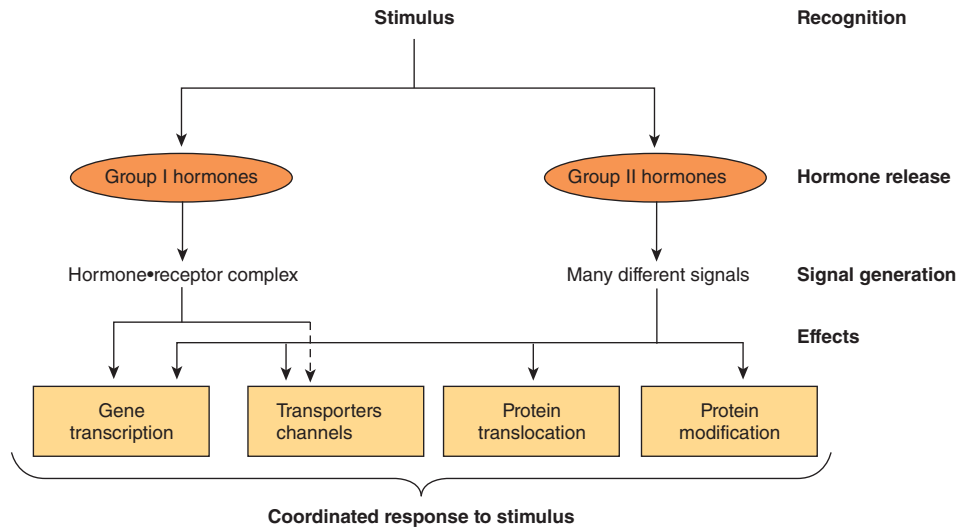

FIGURE 42-1 Hormonal involvement in responses to a stimulus. A challenge to the integrity of the organism elicits a response that includes the release of one or more hormones. These hormones generate signals at or within target cells, and these signals regulate a variety of biologic processes that provide for a coordinated response to the stimulus or challenge. See Figure 42-8 for a specific example.

plasma membrane of target cells. The cytokines, interleukins, and growth factors should also be considered in this latter category. These molecules, of critical importance in homeostatic adaptation, are hormones in the sense that they are produced in specific cells, have the equivalent of autocrine, paracrine, and endocrine actions, bind to cell surface receptors, and activate many of the same signal transduction pathways employed by the more traditional group II hormones.

SIGNAL GENERATION

The Ligand-Receptor Complex Is the Signal for Group I Hormones

The lipophilic group I hormones diffuse through the plasma membrane of all cells but only encounter their specific, high-affinity intracellular receptors in target cells. These receptors can be located in the cytoplasm or in the nucleus of target cells. The hormone-receptor complex first undergoes an **activation reaction**. As shown in Figure 42-2, receptor activation occurs by at least two mechanisms. For example, glucocorticoids diffuse across the plasma membrane and encounter their cognate receptor in the cytoplasm of target cells. Ligand-receptor binding results in a conformational change in the receptor leading to the dissociation of heat shock protein 90 (hsp90). This step is necessary for subsequent nuclear localization of the glucocorticoid receptor. This receptor also contains a nuclear localization sequence that is now free to assist in the translocation from cytoplasm to nucleus. The activated receptor moves into the nucleus (Figure 42-2) and binds with high affinity to a specific DNA sequence called the **hormone response element (HRE)**. In the case illustrated, this is a glucocorticoid response element, or GRE. Consensus sequences for HREs are shown in Table 42-1.

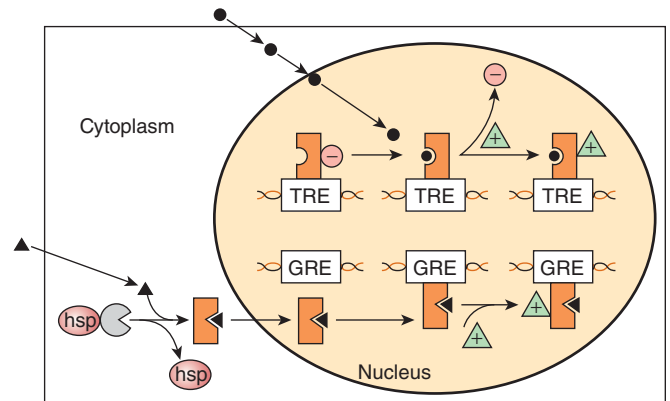

FIGURE 42-2 Regulation of gene expression by two different group I hormones, thyroid hormone and glucocorticoids. The hydrophobic steroid hormones readily gain access to the cytoplasmic compartment of target cells by diffusion through the plasma membrane. Glucocorticoid hormones (solid triangles) encounter their cognate receptor (GR) in the cytoplasm, where GR exists in a complex with a chaperone protein, heat shock protein 90 (hsp). Ligand binding causes dissociation of hsp90 and a conformational change of the receptor. The receptor-ligand complex then traverses the nuclear membrane and binds to DNA with specificity and high affinity at a glucocorticoid response element (GRE). This event affects the architecture of a number of transcription coregulators (green triangles), and enhanced transcription ensues. By contrast, thyroid hormones and retinoic acid (black circle) directly enter the nucleus, where their cognate heterodimeric (TR-RXR; see Figure 42-12) receptors are already bound to the appropriate response elements with an associated transcription corepressor complex (red circles). Hormone-receptor binding occurs, which again induces conformational changes in receptor leading to a reorganization of receptor (TR)-coregulator interactions (ie, molecules such as N-CoR or SMRT [see Table 42-6]). Ligand binding results in dissociation of the corepressor complex from the receptor, allowing an activator complex, consisting of the TR-TRE and coactivator, to assemble. The gene is then actively transcribed.

TABLE 42-1 The DNA Sequences of Several Hormone Response Elements (HREs)^a

Hormone or Effector	HRE	DNA Sequence
Glucocorticoids	GRE	GGTACA _{NNN} TGTCT
Progestins	PRE	←→
Mineralocorticoids	MRE	←→
Androgens	ARE	←→
Estrogens	ERE	AGGTCA — TGACCT
Thyroid hormone	TRE	←→
Retinoic acid	RARE	AGGTCA _{N1-5} AGGTCA
Vitamin D	VDRE	→→
cAMP	CRE	TGACGTCA

^aLetters indicate nucleotide; N means any one of the four can be used in that position. The arrows pointing in opposite directions illustrate the slightly imperfect inverted palindromes present in many HREs; in some cases these are called “half binding sites,” or half-sites, because each binds one monomer of the receptor. The GRE, PRE, MRE, and ARE consist of the same DNA sequence. Specificity may be conferred by the intracellular concentration of the ligand or hormone receptor, by flanking DNA sequences not included in the consensus, or by other accessory elements. A second group of HREs includes those for thyroid hormones, estrogens, retinoic acid, and vitamin D. These HREs are similar except for the orientation and spacing between the half palindromes. Spacing determines the hormone specificity. VDRE ($N = 3$), TRE ($N = 4$), and RARE ($N = 5$) bind to direct repeats rather than to inverted repeats. Another member of the steroid receptor superfamily, the retinoid X receptor (RXR), forms heterodimers with VDR, TR, and RARE, and these constitute the functional forms of these transacting factors. cAMP affects gene transcription through the CRE.

The DNA-bound, liganded receptor serves as a high-affinity binding site for one or more coactivator proteins and accelerated gene transcription typically ensues when this occurs. By contrast, certain hormones such as the thyroid hormones and retinoids diffuse from the extracellular fluid across the plasma membrane and go directly into the nucleus. In this case, the cognate receptor is already bound to the HRE (the thyroid hormone response element [TRE], in this example). However, this DNA-bound receptor fails to activate transcription because it exists in complex with a corepressor. Indeed, this receptor-corepressor complex serves as an active repressor of gene transcription. The association of ligand with these receptors results in dissociation of the corepressor(s). The liganded receptor is now capable of binding one or more coactivators with high affinity, resulting in the recruitment of RNA polymerase II and the GTFs and activation of gene transcription. The relationship of hormone receptors to other nuclear receptors and to coregulators is discussed in more detail below.

By selectively affecting gene transcription and the consequent production of appropriate target mRNAs, the amounts of specific proteins are changed and metabolic processes are influenced. The influence of each of these hormones is quite specific; generally, a given hormone directly affects <1% of the genes, mRNA, or proteins in a target cell; sometimes only a few are affected. The nuclear actions of steroid, thyroid, and retinoid hormones are quite well defined. Most evidence suggests that

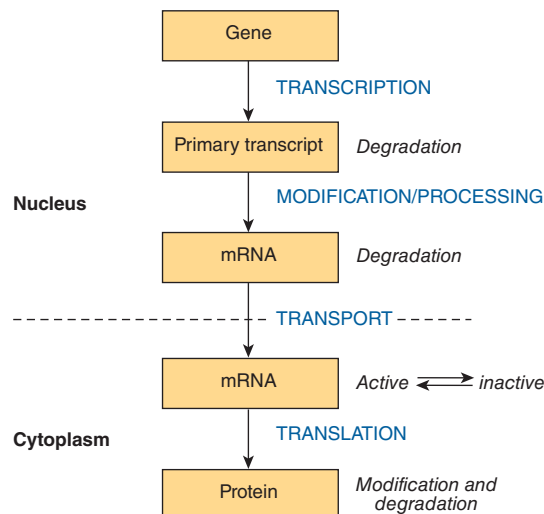

FIGURE 42-3 The “information pathway”. Information flows from the gene to the primary transcript to mRNA to protein. Hormones can affect any of the steps involved and can affect the rates of processing, degradation or modification of the various products.

these hormones exert their dominant effect on modulating gene transcription, but they—and many of the hormones in the other classes discussed below—can act at any step of the “information pathway,” as illustrated in **Figure 42-3**, to control specific gene expression and, ultimately, a biological response. Direct actions of steroids in the cytoplasm and on various organelles and membranes have also been described. Recently, microRNAs have been implicated in mediating some of the diverse actions of hormones.

GROUP II (PEPTIDE & CATECHOLAMINE) HORMONES HAVE MEMBRANE RECEPTORS & USE INTRACELLULAR MESSENGERS

Many hormones are water soluble, have no transport proteins (and therefore have a short plasma half-life), and initiate a response by binding to a receptor located in the plasma membrane (see Tables 41-3 and 41-4). The mechanism of action of this group of hormones can best be discussed in terms of the **intracellular signals** they generate. These signals include **cAMP** (cyclic AMP; 3', 5'-adenylic acid; see Figure 18-5), a nucleotide derived from ATP through the action of adenylyl cyclase; **cGMP**, a nucleotide formed by guanylyl cyclase; **Ca²⁺**; and **phosphatidylinositides**; such small molecules are **termed second messengers** as their synthesis is triggered by the presence of the primary hormone (molecule) binding its receptor. Many of these second messengers affect gene transcription, as described in the previous paragraph; but they also influence a variety of other biologic processes, as shown in Figure 42-3, but see also Figures 42-6 and 42-8.

TABLE 42-2 Subclassification of Group II.A Hormones

Hormones That Stimulate Adenylyl Cyclase (H_s)	Hormones That Inhibit Adenylyl Cyclase (H_i)
ACTH	Acetylcholine
ADH	α_2 -Adrenergics
β -Adrenergics	Angiotensin II
Calcitonin	Somatostatin
CRH	
FSH	
Glucagon	
hCG	
LH	
LPH	
MSH	
PTH	
TSH	

G Protein–Coupled Receptors

Many of the group II hormones bind to receptors that couple to effectors through a **GTP-binding protein (G proteins)** intermediary. These receptors typically have seven hydrophobic plasma membrane-spanning domains. This is illustrated by the seven interconnected helices extending through the lipid bilayer in **Figure 42-4**. Receptors of this class, which

signal through guanine nucleotide-bound protein intermediates, are known as **G protein–coupled receptors (GPCRs)**. To date, hundreds of G protein-linked receptor genes have been identified. GPCRs represent the largest family of cell surface receptors in humans. A wide variety of responses are mediated by the GPCRs.

cAMP Is the Intracellular Signal for Many Responses

Cyclic AMP was the first intracellular second messenger signal identified in mammalian cells. Several components comprise a system for the generation, degradation, and action of cAMP (**Table 42-2**).

Adenylyl Cyclase

Different peptide hormones can either stimulate (s) or inhibit (i) the production of cAMP from adenylyl cyclase through the action of the G proteins. G proteins are encoded by at least ten different genes (**Table 42-3**). Two parallel systems, a stimulatory (s) one and an inhibitory (i) one, converge upon a catalytic molecule (C). Each consists of a receptor, R_s or R_i , and a regulatory complex, G_s and G_i . G_s and G_i are each **heterotrimeric G protein composed of α , β , and γ subunits**. Since the α subunit in G_s differs from that in G_i , the proteins, which are distinct gene products, are designated α_s and α_i . The α subunits bind guanine nucleotides. The β and γ subunits are always associated ($\beta\gamma$) and appear to function as a heterodimer. The binding of a hormone to R_s or R_i results

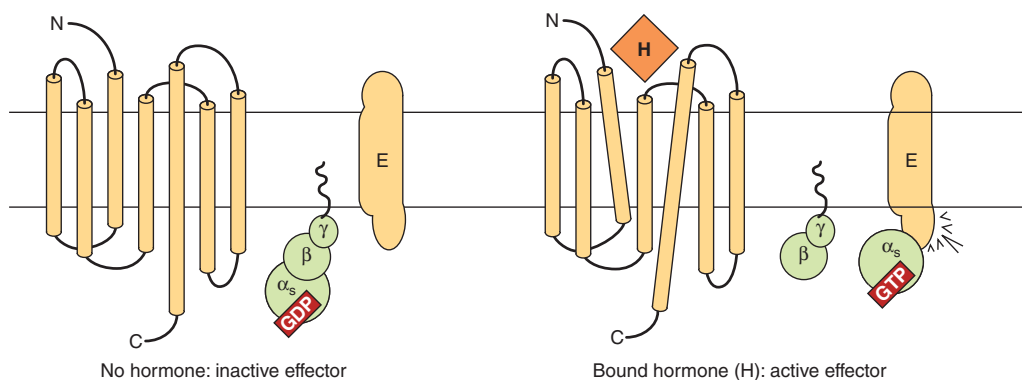

FIGURE 42-4 Components of the hormone receptor–G protein effector system. Receptors that couple to effectors through G proteins, the G protein coupled receptors (GPCRs), typically have seven α -helical membrane-spanning domains (here shown as long cylinders). In the absence of hormone (**left**), the heterotrimeric G-protein complex (α, β, γ) is in an inactive guanosine diphosphate (GDP)-bound form and is probably not associated with the receptor. This complex is anchored to the plasma membrane through prenylated groups on the $\beta\gamma$ subunits (**wavy lines**) and perhaps by myristoylated groups on α subunits (not shown). On binding of hormone (H) to the receptor, there are conformational changes within the receptor—as indicated by the tilted membrane spanning domains—and activation of the G-protein complex. This results from the exchange of GDP with guanosine triphosphate (GTP) on the α subunit, after which α and $\beta\gamma$ dissociate. The α subunit binds to and activates the effector (E). E can be adenylyl cyclase, Ca^{2+} , Na^+ , or Cl^- channels (α_s), or it could be a K^+ channel (α_i), phospholipase C β (α_q), or cGMP phosphodiesterase (α_i); see **Table 42-3**. The β subunit can also have direct actions on E. (Modified and reproduced, with permission, from Granner DK. In: *Principles and Practice of Endocrinology and Metabolism*, 2nd ed. Becker KL (editor). Lippincott, 1995.)

TABLE 42-3 Classes and Functions of Selected G Proteins^a

Class or Type	Stimulus	Effector	Effect
G_s			
α_s	Glucagon, β -adrenergics	\uparrow Adenylyl cyclase	Glyconeogenesis, lipolysis, glycogenolysis
α_{olf}	Odorant	\uparrow Cardiac Ca^{2+} , Cl^- , and Na^+ channels	Olfaction
α_{olf}	Odorant	\uparrow Adenylyl cyclase	
G_i			
$\alpha_{i-1,2,3}$	Acetylcholine, α_2 -adrenergics	\downarrow Adenylyl cyclase \uparrow Potassium channels	Slowed heart rate
	M_2 cholinergics	\downarrow Calcium channels	
α_o	Opioids, endorphins	\uparrow Potassium channels	Neuronal electrical activity
α_t	Light	\uparrow cGMP phosphodiesterase	Vision
G_q			
α_q	M_1 cholinergics		
	α_1 -Adrenergics	\uparrow Phospholipase C- β 1	\downarrow Muscle contraction and
α_{11}	α_1 -Adrenergics	\uparrow Phospholipase C- β 2	\downarrow Blood pressure
G_{12}			
α_{12}	Thrombin	Rho	Cell shape changes

^aThe four major classes or families of mammalian G proteins (G_s , G_i , G_q , and G_{12}) are based on protein sequence homology. Representative members of each are shown, along with known stimuli, effectors, and well-defined biologic effects. Nine isoforms of adenylyl cyclase have been identified (isoforms I—IX). All isoforms are stimulated by α_s ; α_i isoforms inhibit types V and VI, and α_o inhibits types I and V. At least 16 different α subunits have been identified. **Source:** Modified and reproduced, with permission, from Granner DK. In: *Principles and Practice of Endocrinology and Metabolism*, 2nd ed. Becker KL (editor). Lippincott, 1995.

in a receptor-mediated activation of G protein, which entails the exchange of GDP by GTP on α and the concomitant dissociation of $\beta\gamma$ from α .

The α_s protein has intrinsic GTPase activity. The active form, α_s -GTP, is inactivated upon hydrolysis of the GTP to GDP; the trimeric G_s complex ($\alpha\beta\gamma$) is then re-formed and is ready for another cycle of activation. Cholera and pertussis toxins catalyze the ADP ribosylation of α_s and α_{i-2} (Table 42-3), respectively. In the case of α_s , this modification disrupts the intrinsic GTPase activity; thus, α_s cannot reassociate with $\beta\gamma$ and is therefore irreversibly activated. ADP ribosylation of α_{i-2} prevents the dissociation of α_{i-2} from $\beta\gamma$, and free α_{i-2} thus cannot be formed. α_s activity in such cells is therefore unopposed.

There is a large family of G proteins, and these are part of the superfamily of GTPases. The G protein family is classified according to sequence homology into four subfamilies, as illustrated in Table 42-3. There are 21 α , 5 β , and 8 γ subunit genes. Various combinations of these subunits provide a large number of possible $\alpha\beta\gamma$ and cyclase complexes.

The α subunits and the $\beta\gamma$ complex have actions independent of those on adenylyl cyclase (see Figure 42-4 and Table 42-3). Some forms of α_i stimulate K^+ channels and inhibit Ca^{2+} channels, and some α_s molecules have the opposite effects. Members of the G_q family activate the phospholipase C group of enzymes. The $\beta\gamma$ complexes have been associated with K^+ channel stimulation and phospholipase C activation. G proteins are involved in many important biologic processes

in addition to hormone action. Notable examples include olfaction (α_{OLF}) and vision (α_t). Some examples are listed in Table 42-3. GPCRs are implicated in a number of diseases and are major targets for pharmaceutical agents.

Protein Kinase

As discussed in Chapter 38, in prokaryotic cells, cAMP binds to a specific protein called catabolite regulatory protein (CRP) that binds directly to DNA and influences gene expression. By contrast, in eukaryotic cells, cAMP binds to a protein kinase called **protein kinase A (PKA)**, a heterotetrameric molecule consisting of two regulatory subunits (R) that inhibit the activity of the two catalytic subunits (C) when bound as a tetrameric complex. cAMP binding to the R_2C_2 tetramer results in the following reaction:

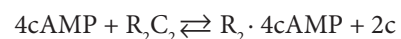

The R_2C_2 complex has no enzymatic activity, but the binding of cAMP by R induces dissociation of the R-C complex, thereby activating the latter (Figure 42-5). The active C subunit catalyzes the transfer of the γ phosphate of ATP to a serine or threonine residue in a variety of proteins. The consensus PKA phosphorylation sites are -ArgArg/Lys-X-Ser/Thr- and -Arg-Lys-X-X-Ser-, where X can be any amino acid.

Historically protein kinase activities were described as being “cAMP-dependent” or “cAMP-independent.” This classification

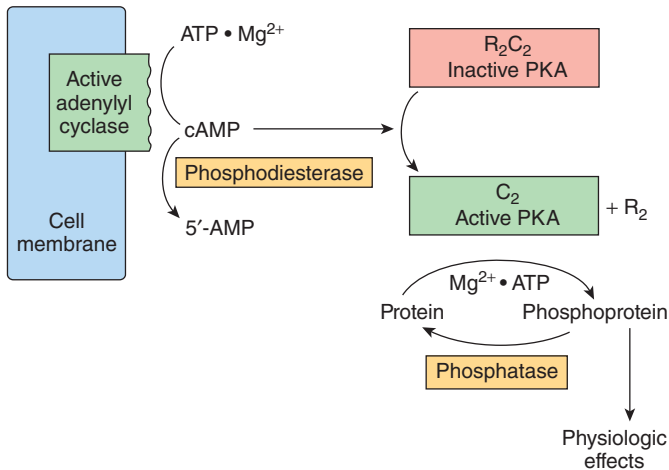

FIGURE 42-5 Hormonal regulation of cellular processes through cAMP-dependent protein kinase (PKA). PKA exists in an inactive form as an R_2C_2 heterotetramer consisting of two regulatory (R) and two catalytic (C) subunits. The cAMP generated by the action of adenylyl cyclase (activated as shown in Figure 42-4) binds to the regulatory subunit of PKA. This results in dissociation of the regulatory and catalytic subunits and activation of the latter. The active catalytic subunits phosphorylate a number of target proteins on serine and threonine residues. Phosphatases remove phosphate from these residues and thus terminate the physiologic response. A phosphodiesterase can also terminate the response by converting cAMP to 5'-AMP.

has changed, as protein phosphorylation is now recognized as being a major and ubiquitous regulatory mechanism. Several hundred protein kinases have now been described. These kinases are related in sequence and structure within the catalytic domain, but each is a unique molecule with considerable variability with respect to subunit composition, molecular weight, autophosphorylation, K_m for ATP, and substrate specificity. Both kinase and protein phosphatase activities can be targeted by interaction with specific kinase binding proteins. In the case of PKA, such targeting proteins are termed A kinase anchoring proteins, or **AKAPs**. AKAPs serve as scaffolds, which localize PKA near to substrates thereby focusing PKA activity toward physiological substrates and facilitating spatiotemporal biological regulation while also allowing for common, shared proteins to elicit specific physiological responses. Multiple AKAPs have been described and importantly they can bind PKA and other kinases as well as phosphatases, phosphodiesterases (which hydrolyze cAMP), and protein kinase substrates. The multifunctionality of AKAPs facilitates signaling localization, rate (production and destruction of signals), specificity and dynamics.

Phosphoproteins

The effects of cAMP in eukaryotic cells are all thought to be mediated by protein phosphorylation-dephosphorylation, principally on serine and threonine residues. The control of any of the effects of cAMP, including such diverse processes as steroidogenesis, secretion, ion transport, carbohydrate and fat metabolism, enzyme induction, gene regulation, synaptic transmission, and cell growth and replication, could be

conferred by a specific protein kinase, by a specific phosphatase, or by specific substrates for phosphorylation. The array of specific substrates define a target tissue, and are involved in defining the extent of a particular response within a given cell. For example, the effects of cAMP on gene transcription are mediated by **CREB**, the cyclic AMP response element binding protein. CREB binds to a cAMP responsive DNA enhancer element (**CRE**) (see Table 42-1) in its nonphosphorylated state and is a weak activator of transcription. When phosphorylated by PKA, CREB binds the coactivator **CREB-binding protein CBP/p300** (see below) and as a result is a much more potent transcription activator. CBP and the related p300 contain histone acetyltransferase activities, and hence serve as chromatin-active transcriptional coregulators (see Chapters 36, 38). Interestingly, CBP/p300 can also acetylate certain transcription factors thereby stimulating their ability to bind DNA and modulate transcription.

Phosphodiesterases

Actions caused by hormones that increase cAMP concentration can be terminated in a number of ways, including the hydrolysis of cAMP to 5'-AMP by phosphodiesterases (see Figure 42-5). The presence of these hydrolytic enzymes ensures a rapid turnover of the signal (cAMP) and hence a rapid termination of the biologic process once the hormonal stimulus is removed. There are at least 11 known members of the phosphodiesterase family of enzymes. These are subject to regulation by their substrates, cAMP and cGMP; by hormones; and by intracellular messengers such as calcium, probably acting through calmodulin. Inhibitors of phosphodiesterase, most notably methylated xanthine derivatives such as caffeine, increase intracellular cAMP and mimic or prolong the actions of hormones through this signal.

Phosphoprotein Phosphatases

Given the importance of protein phosphorylation, it is not surprising that regulation of the protein dephosphorylation reaction is another important control mechanism (see Figure 42-5). The phosphoprotein phosphatases are themselves subject to regulation by phosphorylation-dephosphorylation reactions and by a variety of other mechanisms, such as protein-protein interactions. In fact, the substrate specificity of the phosphoserine-phosphothreonine phosphatases may be dictated by distinct regulatory subunits whose binding is regulated hormonally. One of the best-studied roles of regulation by the dephosphorylation of proteins is that of glycogen metabolism in muscle (see Figures 18-6 to 18-8). Two major types of phosphoserine-phosphothreonine phosphatases have been described. Type I preferentially dephosphorylates the β subunit of phosphorylase kinase, whereas type II dephosphorylates the α subunit. Type I phosphatase is implicated in the regulation of glycogen synthase, phosphorylase, and phosphorylase kinase. This phosphatase is itself regulated by phosphorylation of certain of its subunits, and these reactions are reversed by the action of one of the type II phosphatases. In addition,

two heat-stable protein inhibitors regulate type I phosphatase activity. Inhibitor-1 is phosphorylated and activated by cAMP-dependent protein kinases, and inhibitor-2, which may be a subunit of the inactive phosphatase, is also phosphorylated, possibly by glycogen synthase kinase-3. Phosphatases that target phosphotyrosine are also important in signal transduction (see Figure 42–8).

cGMP Is Also an Intracellular Signal

Cyclic GMP is made from GTP by the enzyme guanylyl cyclase, which exists in soluble and membrane-bound forms. Each of these enzyme forms has unique physiologic properties. The atriopeptins, a family of peptides produced in cardiac atrial tissues, cause natriuresis, diuresis, vasodilation, and inhibition of aldosterone secretion. These peptides (eg, atrial natriuretic factor) bind to and activate the membrane-bound form of guanylyl cyclase. This results in an increase of cGMP by as much as 50-fold in some cases, and this is thought to mediate the effects mentioned above. Other evidence links cGMP to vasodilation. A series of compounds, including nitroprusside, nitroglycerin, nitric oxide, sodium nitrite, and sodium azide, all cause smooth muscle relaxation and are potent vasodilators. These agents increase cGMP by activating the soluble form of guanylyl cyclase, and inhibitors of cGMP phosphodiesterase (the drug sildenafil [Viagra], for example) enhance and prolong these responses. The increased cGMP activates cGMP-dependent protein kinase (PKG), which in turn phosphorylates a number of smooth muscle proteins. Presumably, this is involved in relaxation of smooth muscle and vasodilation.

Several Hormones Act Through Calcium or Phosphatidylinositols

Ionized calcium, Ca^{2+} , is an important regulator of a variety of cellular processes, including muscle contraction, stimulus-secretion coupling, blood clotting cascade, enzyme activity, and membrane excitability. Ca^{2+} is also an intracellular messenger of hormone action.

Calcium Metabolism

The extracellular Ca^{2+} concentration is ~ 5 mmol/L and is very rigidly controlled. Although substantial amounts of calcium are associated with intracellular organelles such as mitochondria and the endoplasmic reticulum, the intracellular concentration of free or ionized calcium (Ca^{2+}) is very low: 0.05 to 10 $\mu\text{mol/L}$. In spite of this large concentration gradient and a favorable transmembrane electrical gradient, Ca^{2+} is restrained from entering the cell. A considerable amount of energy is expended to ensure that the intracellular Ca^{2+} is controlled, as a prolonged elevation of Ca^{2+} in the cell is very toxic. A $\text{Na}^+/\text{Ca}^{2+}$ exchange mechanism that has a high-capacity but low-affinity pumps Ca^{2+} out of cells. There also is a Ca^{2+} /proton ATPase-dependent pump that extrudes Ca^{2+} in exchange for H^+ . This has a high affinity for Ca^{2+} but a low

capacity and is probably responsible for fine-tuning cytosolic Ca^{2+} . Furthermore, Ca^{2+} -ATPases pump Ca^{2+} from the cytosol to the lumen of the endoplasmic reticulum. There are three ways of changing cytosolic Ca^{2+} levels: (1) Certain hormones (class II.C, Table 41–3) by binding to receptors that are themselves Ca^{2+} channels, enhance membrane permeability to Ca^{2+} , and thereby increase Ca^{2+} influx. (2) Hormones also indirectly promote Ca^{2+} influx by modulating the membrane potential at the plasma membrane. Membrane depolarization opens voltage-gated Ca^{2+} channels and allows for Ca^{2+} influx. (3) Ca^{2+} can be mobilized from the endoplasmic reticulum, and possibly from mitochondrial pools.

An important observation linking Ca^{2+} to hormone action involved the definition of the intracellular targets of Ca^{2+} action. The discovery of a Ca^{2+} -dependent regulator of phosphodiesterase activity provided the basis for a broad understanding of how Ca^{2+} and cAMP interact within cells.

Calmodulin

The calcium-dependent regulatory protein is calmodulin, a 17-kDa protein that is homologous to the muscle protein troponin C in structure and function. Calmodulin has four Ca^{2+} binding sites, and full occupancy of these sites leads to a marked conformational change, which allows calmodulin to activate enzymes and ion channels. The interaction of Ca^{2+} with calmodulin (with the resultant change of activity of the latter) is conceptually similar to the binding of cAMP to PKA and the subsequent activation of this molecule. Calmodulin can be one of numerous subunits of complex proteins and is particularly involved in regulating various kinases and enzymes of cyclic nucleotide generation and degradation. A partial list of the enzymes regulated directly or indirectly by Ca^{2+} , probably through calmodulin, is presented in Table 42–4.

In addition to its effects on enzymes and ion transport, Ca^{2+} /calmodulin regulates the activity of many structural elements in cells. These include the actin-myosin complex of smooth muscle, which is under β -adrenergic control, and various microfilament-mediated processes in noncontractile cells, including cell motility, cell conformation changes, mitosis, granule release, and endocytosis.

TABLE 42–4 Some Enzymes and Proteins Regulated by Calcium or Calmodulin

- Adenylyl cyclase
- Ca^{2+} -dependent protein kinases
- Ca^{2+} - Mg^{2+} -ATPase
- Ca^{2+} -phospholipid-dependent protein kinase
- Cyclic nucleotide phosphodiesterase
- Some cytoskeletal proteins
- Some ion channels (eg, I-type calcium channels)
- Nitric oxide synthase
- Phosphorylase kinase
- Phosphoprotein phosphatase 2B
- Some receptors (eg, NMDA-type glutamate receptor)

Calcium Is a Mediator of Hormone Action

A role for Ca^{2+} in hormone action is suggested by the observations that the effect of many hormones is (1) blunted by Ca^{2+} -free media or when intracellular calcium is depleted; (2) can be mimicked by agents that increase cytosolic Ca^{2+} , such as the Ca^{2+} ionophore A23187; and (3) influences cellular calcium flux. Again, the regulation of glycogen metabolism in liver (by vasopressin and β -adrenergic catecholamines; Figures 18–6 and 18–7.)

A number of critical metabolic enzymes are regulated by Ca^{2+} , phosphorylation, or both. These include glycogen synthase, pyruvate kinase, pyruvate carboxylase, glycerol-3-phosphate dehydrogenase, and pyruvate dehydrogenase among others (see Figure 19–1).

Phosphatidylinositide Metabolism Affects Ca^{2+} -Dependent Hormone Action

Some signal must provide communication between the hormone receptor on the plasma membrane and the intracellular Ca^{2+} reservoirs. This is accomplished by products of

phosphatidylinositol metabolism. Cell surface receptors such as those for acetylcholine, antidiuretic hormone, and α_1 -type catecholamines are, when occupied by their respective ligands, potent activators of phospholipase C. Receptor binding and activation of phospholipase C are coupled by the G_q isoforms (Table 42–3 and Figure 42–6). Phospholipase C catalyzes the hydrolysis of phosphatidylinositol 4,5-bisphosphate to inositol trisphosphate (IP_3) and 1,2-diacylglycerol (Figure 42–7). Diacylglycerol (DAG) is itself capable of activating **protein kinase C (PKC)**, the activity of which also depends upon Ca^{2+} (see Figures 21–10; 24–1, 24–2, and 55–7). IP_3 , by interacting with a specific intracellular receptor, is an effective releaser of Ca^{2+} from intracellular storage sites in the endoplasmic reticulum. Thus, the hydrolysis of phosphatidylinositol 4,5-bisphosphate leads to activation of PKC and promotes an increase of cytoplasmic Ca^{2+} . As shown in Figure 42–4, the activation of G proteins can also have a direct action on Ca^{2+} channels. The resulting elevations of cytosolic Ca^{2+} activate Ca^{2+} -calmodulin-dependent kinases and many other Ca^{2+} -calmodulin-dependent enzymes.

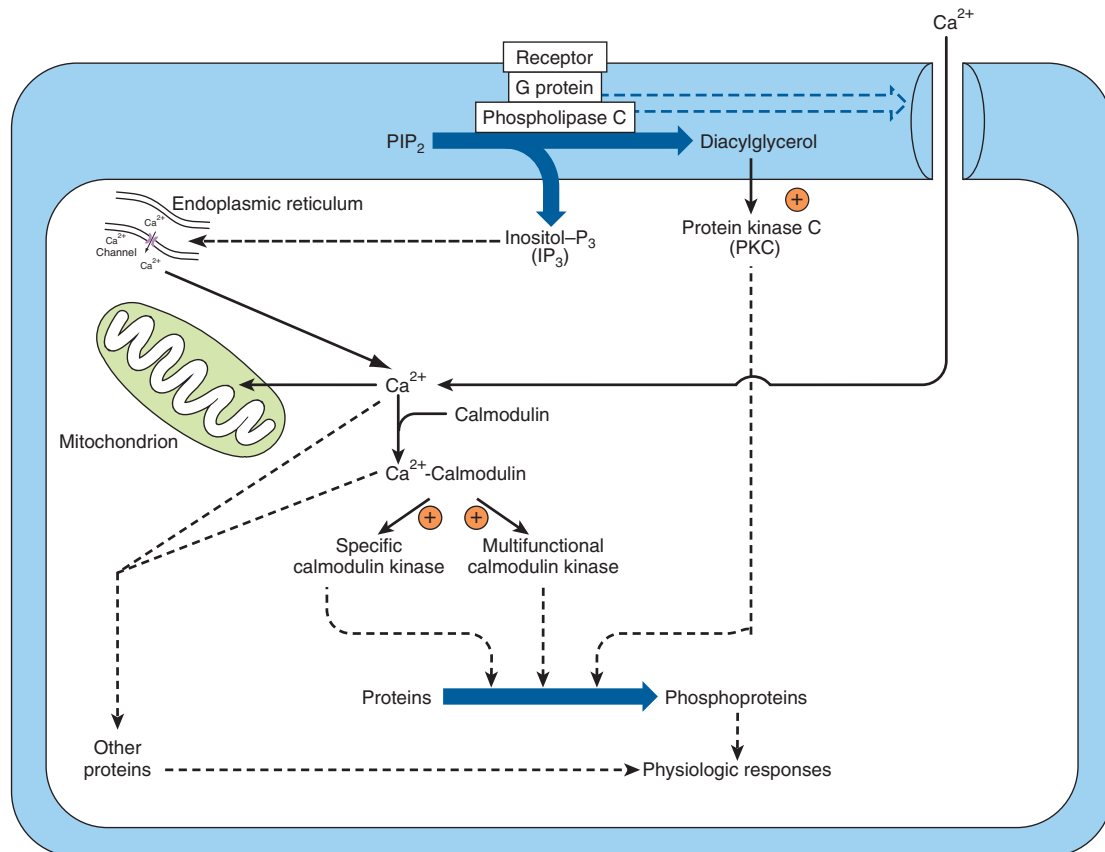

FIGURE 42–6 Certain hormone-receptor interactions result in the activation of phospholipase C (PLC).

PLC activation appears to involve a specific G protein, which also may activate a calcium channel. Phospholipase C generates inositol trisphosphate (IP_3), which liberates stored intracellular Ca^{2+} , and diacylglycerol (DAG), a potent activator of protein kinase C (PKC). In this scheme, the activated PKC phosphorylates specific substrates, which then alter physiologic processes. Likewise, the Ca^{2+} -calmodulin complex can activate specific kinases, two of which are shown here. These actions result in phosphorylation of substrates, and this leads to altered physiologic responses. This figure also shows that Ca^{2+} can enter cells through voltage- or ligand-gated Ca^{2+} channels. The intracellular Ca^{2+} is also regulated through storage and release by the mitochondria and endoplasmic reticulum. (Courtesy of JH Exton.)

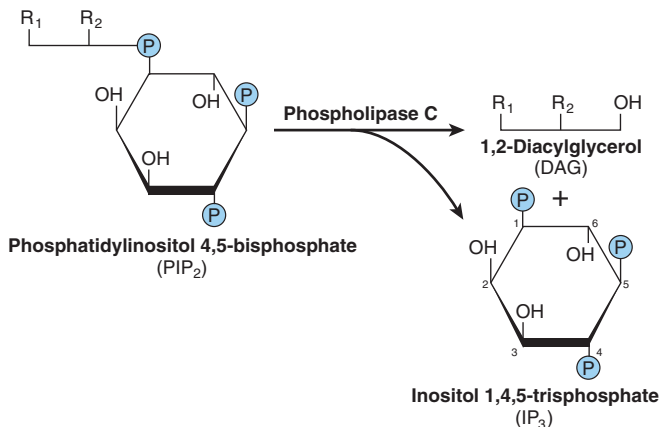

FIGURE 42-7 Phospholipase C cleaves PIP₂ into diacylglycerol and inositol trisphosphate. R₁ generally is stearate, and R₂ is usually arachidonate. IP₃ can be dephosphorylated (to the inactive I-1,4-P₂) or phosphorylated (to the potentially active I-1,3,4,5-P₄).

Steroidogenic agents—including ACTH and cAMP in the adrenal cortex; angiotensin II, K⁺, serotonin, ACTH, and cAMP in the zona glomerulosa of the adrenal; LH in the ovary; and LH and cAMP in the Leydig cells of the testes—have been associated with increased amounts of phosphatidic acid, phosphatidylinositol, and polyphosphoinositides (see Chapter 21) in the respective target tissues. Several other examples could be cited.

The roles that Ca²⁺ and polyphosphoinositide breakdown products might play in hormone action are presented in Figure 42-6. In this scheme, the activated protein kinase C can phosphorylate specific substrates, which then alter physiologic processes. Likewise, the Ca²⁺-calmodulin complex can activate specific kinases. These then modify substrates and thereby alter physiologic responses.

Some Hormones Act Through a Protein Kinase Cascade

Single protein kinases such as PKA, PKC, and Ca²⁺-calmodulin (CaM)-kinases, which result in the phosphorylation of serine and threonine residues in target proteins, play a very important role in hormone action. The discovery that the EGF receptor contains an intrinsic tyrosine kinase activity that is activated by the binding of the ligand EGF was an important breakthrough. The insulin and IGF-I receptors also contain intrinsic ligand-activated tyrosine kinase activity. Several receptors—generally those involved in binding ligands involved in growth control, differentiation, and the inflammatory response—either have intrinsic tyrosine kinase activity or are associated with proteins that are tyrosine kinases. Another distinguishing feature of this class of hormone action is that these kinases preferentially phosphorylate tyrosine residues, and tyrosine phosphorylation is infrequent (<0.03% of total amino acid phosphorylation) in mammalian cells. A third distinguishing feature is that the ligand-receptor interaction that results in a tyrosine phosphorylation event initiates a cascade

that may involve several protein kinases, phosphatases, and other regulatory proteins.

Insulin Transmits Signals by Several Kinase Cascades

The insulin, epidermal growth factor (EGF), and IGF-I receptors have intrinsic protein tyrosine kinase activities located in their cytoplasmic domains. These activities are stimulated when their ligands bind to the cognate receptor. The receptors are then autophosphorylated on tyrosine residues, and this initiates a complex series of events (summarized in simplified fashion in Figure 42-8). The phosphorylated insulin receptor next phosphorylates **insulin receptor substrates** (there are at least four of these molecules, called IRS 1-4) on tyrosine residues. Phosphorylated IRS binds to the **Src homology 2 (SH2)** domains of a variety of proteins that are directly involved in mediating different effects of insulin. One of these proteins, PI-3 kinase, links insulin receptor activation to insulin action through activation of a number of molecules, including the kinase **PDK1** (phosphoinositide-dependent kinase-1). This enzyme propagates the signal through several other kinases, including **PKB** (also known as **AKT**), **SKG**, and **aPKC** (see legend to Figure 42-8 for definitions and expanded abbreviations). An alternative pathway downstream from PDK1 involves **p70S6K** and perhaps other as yet unidentified kinases. A second major pathway involves **mTOR**. This enzyme is directly regulated by amino acid levels and insulin and is essential for p70S6K activity. This pathway provides a distinction between the PKB and p70S6K branches downstream from PKD1. These pathways are involved in protein translocation, enzyme activity, and the regulation, by insulin, of genes involved in metabolism (Figure 42-8). Another SH2 domain-containing protein is **GRB2**, which binds to IRS-1 and links tyrosine phosphorylation to several proteins, the result of which is activation of a cascade of threonine and serine kinases. A pathway showing how this insulin-receptor interaction activates the mitogen-activated protein kinase (**MAPK**) pathway and the anabolic effects of insulin is illustrated in Figure 42-8. The exact roles of many of these docking proteins, kinases, and phosphatases remain to be established.

The Jak/STAT Pathway Is Used by Hormones and Cytokines

Tyrosine kinase activation can also initiate a phosphorylation and dephosphorylation cascade that involves the action of several other protein kinases and the counterbalancing actions of phosphatases. Two mechanisms are employed to initiate this cascade. Some hormones, such as growth hormone, prolactin, erythropoietin, and the cytokines, initiate their action by activating a tyrosine kinase, but this activity is not an integral part of the hormone receptor. The hormone-receptor interaction promotes binding and activation of **cytoplasmic protein tyrosine kinases**, such as **Tyk-2**, **Jak1**, or **Jak2**.

These kinases phosphorylate one or more cytoplasmic proteins, which then associate with other docking proteins

Response to hyperglycemia:

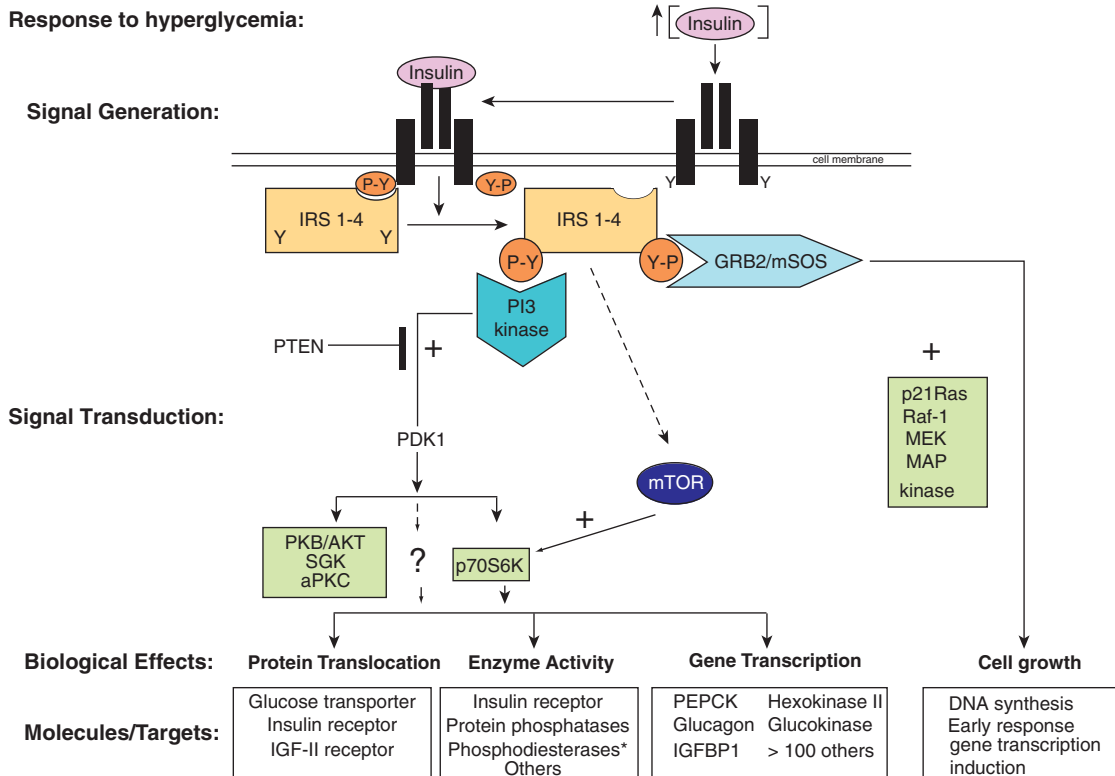

FIGURE 42-8 Insulin signaling pathways. The insulin signaling pathways provide an excellent example of the “recognition → hormone release → signal generation → effects” paradigm outlined in Figure 42-1. Insulin is released into the bloodstream from pancreatic β-cells in response to hyperglycemia. Binding of insulin to a target cell-specific plasma membrane heterotetrameric insulin receptor (IR) results in a cascade of intracellular events. First, the intrinsic tyrosine kinase activity of the insulin receptor is activated, and marks the initial event. Receptor activation results in increased tyrosine phosphorylation (conversion of specific Y residues → Y-P) within the receptor. One or more of the insulin receptor substrate (IRS) molecules (IRS 1-4) then bind to the tyrosine-phosphorylated receptor and themselves are specifically tyrosine phosphorylated. IRS proteins interact with the activated IR via N-terminal PH (pleckstrin homology) and PTB (phosphotyrosine binding) domains. IR-docked IRS proteins are tyrosine phosphorylated and the resulting P-Y-residues form the docking sites for several additional signaling proteins (ie, PI-3 kinase, GRB2, and mTOR). GRB2 and PI3K bind to IRS P-Y residues via their SH (*Src* Homology) domains. Binding to IRS-Y-P residues leads to activation of the activity of many intracellular signaling molecules such as GTPases, protein kinases, and lipid kinases, all of which play key roles in certain metabolic actions of insulin. The two best-described pathways are shown. In detail, phosphorylation of an IRS molecule (probably IRS-2) results in docking and activation of the lipid kinase, PI-3 kinase; PI-3K generates novel inositol lipids that act as “second messenger” molecules. These, in turn, activate PDK1 and then a variety of downstream signaling molecules, including protein kinase B (PKB/AKT), SGK, and aPKC. An alternative pathway involves the activation of p70S6K and perhaps other as yet unidentified kinases. Next, phosphorylation of IRS (probably IRS-1) results in docking of GRB2/mSOS and activation of the small GTPase, p21Ras, which initiates a protein kinase cascade that activates Raf-1, MEK, and the p42/p44 MAP kinase isoforms. These protein kinases are important in the regulation of proliferation and differentiation of many cell types. The mTOR pathway provides an alternative way of activating p70S6K and appears to be involved in nutrient signaling as well as insulin action. Each of these cascades may influence different biological processes, as shown (protein translocation, protein/enzyme activity, gene transcription, cell growth). All of the phosphorylation events are reversible through the action of specific phosphatases. As an example, the lipid phosphatase PTEN dephosphorylates the product of the PI-3 kinase reaction, thereby antagonizing the pathway and terminating the signal. Representative effects of major actions of insulin are shown in each of the boxes. The asterisk after phosphodiesterase indicates that insulin indirectly affects the activity of many enzymes by activating phosphodiesterases and reducing intracellular cAMP levels. (aPKC, atypical protein kinase C; GRB2, growth factor receptor binding protein 2; IGFBP, insulin-like growth factor binding protein; IRS 1-4, insulin receptor substrate isoforms 1-4; MAP kinase, mitogen-activated protein kinase; MEK, MAP kinase kinase and ERK kinase; mSOS, mammalian son of sevenless; mTOR, mammalian target of rapamycin; p70S6K, p70 ribosomal protein S6 kinase; PDK1, phosphoinositide-dependent kinase; PI-3 kinase, phosphatidylinositol 3-kinase; PKB, protein kinase B; PTEN, phosphatase and tensin homolog deleted on chromosome 10; SGK, serum and glucocorticoid-regulated kinase.)

through binding to SH2 domains. One such interaction results in the activation of a family of cytosolic proteins called **STATs**, or signal transducers and activators of transcription. The phosphorylated STAT protein dimerizes and translocates into the nucleus, binds to a specific DNA element such as the interferon response element (IRE), and activates transcription. This is illustrated in **Figure 42–9**. Other SH2 docking events may result in the activation of PI-3 kinase, the MAP kinase pathway (through SHC or GRB2), or G protein-mediated activation of phospholipase C (PLC γ) with the attendant production of diacylglycerol and activation of protein kinase C. It is apparent that there is a potential for “cross-talk” when different hormones activate these various signal transduction pathways.

The NF- κ B Pathway Is Regulated by Glucocorticoids

The transcription factor **NF- κ B** is a heterodimeric complex typically composed of two subunits termed **p50** and **p65** (**Figure 42–10**). Normally NF- κ B is sequestered in the cytoplasm, in a transcriptionally inactive form by members of the **I κ B** (inhibitor of NF- κ B) family of proteins. Extracellular stimuli such as proinflammatory cytokines, reactive oxygen species, and mitogens lead to activation of the **IKK** (I κ B kinase) **complex**, which is a heterohexameric structure consisting of α , β , and γ subunits. IKK phosphorylates I κ B on two serine residues, and this targets I κ B for polyubiquitylation and subsequent degradation by the proteasome. Following I κ B degradation, free NF- κ B translocates to the nucleus, where it binds to a number of gene promoters and activates transcription, particularly of genes involved in the **inflammatory**

response. Transcriptional regulation by NF- κ B is mediated by a variety of coactivators such as CREB binding protein (CBP), as described below (**Figure 42–13**).

Glucocorticoid hormones are therapeutically useful agents for the treatment of a variety of inflammatory and immune diseases. Their anti-inflammatory and immunomodulatory actions are explained in part by the inhibition of NF- κ B and its subsequent actions. Evidence for three mechanisms for the inhibition of NF- κ B by glucocorticoids has been described: (1) glucocorticoids increase I κ B mRNA, which leads to an increase of I κ B protein and more efficient sequestration of NF- κ B in the cytoplasm. (2) The glucocorticoid receptor competes with NF- κ B for binding to coactivators. (3) The glucocorticoid receptor directly binds to the p65 subunit of NF- κ B and inhibits its activation (**Figure 42–10**).

HORMONES CAN INFLUENCE SPECIFIC BIOLOGIC EFFECTS BY MODULATING TRANSCRIPTION

The signals generated as described above have to be translated into an action that allows the cell to effectively adapt to a challenge (**Figure 42–1**). Much of this adaptation is accomplished through alterations in the rates of transcription of specific genes. Many different observations have led to the current view of how hormones affect transcription. Some of these are as follows: (1) actively transcribed genes are in regions of “open” chromatin (experimentally defined as relative susceptibility to the enzyme DNase I), which allows for the access of transcription factors to DNA. (2) Genes have regulatory

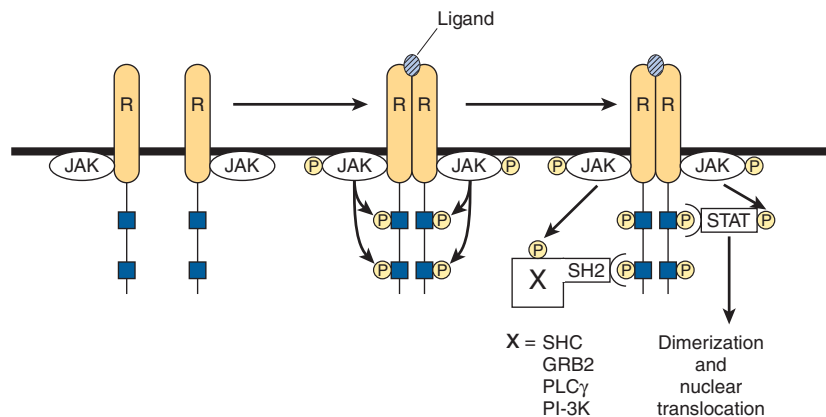

FIGURE 42–9 Initiation of signal transduction by receptors linked to Jak kinases. The receptors (R) that bind prolactin, growth hormone, interferons, and cytokines lack endogenous tyrosine kinase. Upon ligand binding, these receptors dimerize and an associated protein (Jak1, Jak2, or TYK) is phosphorylated. Jak-P, an active kinase, phosphorylates the receptor on tyrosine residues. The STAT proteins associate with the phosphorylated receptor and then are themselves phosphorylated by Jak-P. The phosphorylated STAT protein, STAT (P) dimerizes, translocates to the nucleus, binds to specific DNA elements, and regulates transcription. The phosphorylated tyrosine residues of the receptor also bind to several SH2 domain-containing proteins (X-SH2). This results in activation of the MAP kinase pathway (through SHC or GRB2), PLC γ , or PI-3 kinase.

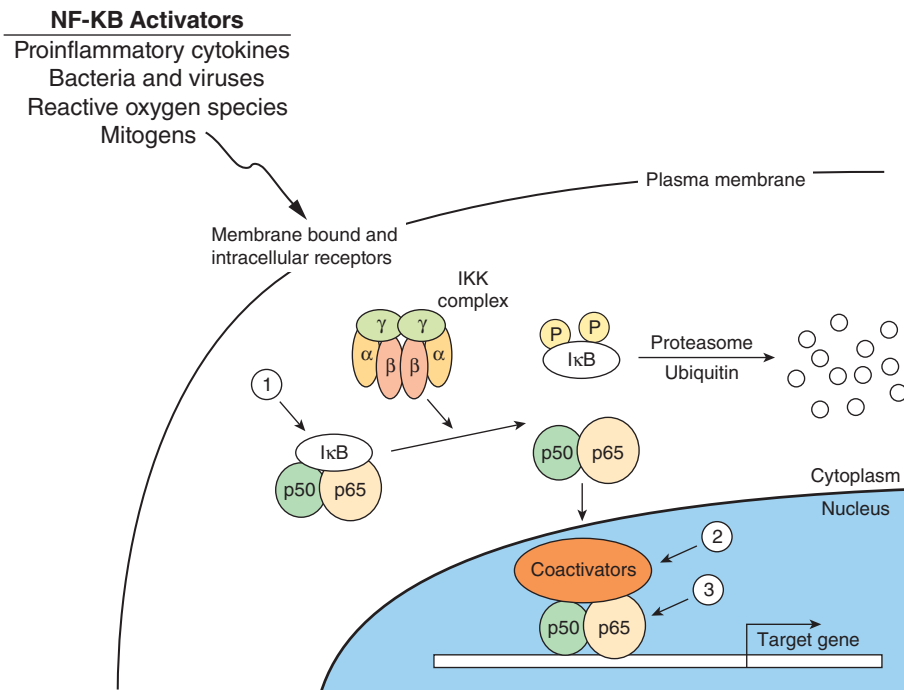

FIGURE 42–10 Regulation of the NF-κ β pathway. NF-κ β consists of two subunits, p50 and p65, which when present in the nucleus regulate transcription of the multitude of genes important for the inflammatory response. NF-κ β is restricted from entering the nucleus by IκB, an inhibitor of NF-κ β . IκB binds to—and masks—the nuclear localization signal of NF-κ β . This cytoplasmic protein is phosphorylated by an IKK complex which is activated by cytokines, reactive oxygen species, and mitogens. Phosphorylated IκB can be ubiquitinated and degraded, thus releasing its hold on NF-κ β , and allowing for nuclear translocation. Glucocorticoids, potent anti-inflammatory agents, are thought to affect at least three steps in this process (1, 2, 3), as described in the text.

regions, and transcription factors bind to these to modulate the frequency of transcription initiation. (3) The hormone-receptor complex can be one of these transcription factors. The DNA sequence to which this binds is called a HRE (see Table 42–1 for examples). (4) Alternatively, other hormone-generated signals can modify the location, amount, or activity of transcription factors and thereby influence binding to the regulatory or response element. (5) Members of a large superfamily of nuclear receptors act with—or in a manner analogous to—the hormone receptors described above. (6) These nuclear receptors interact with another large group of coregulatory molecules to effect changes in the transcription of specific genes.

Several HREs Have Been Defined

HREs resemble enhancer elements in that they are not strictly dependent on position and location or orientation. They generally are found within a few hundred nucleotides upstream (5') of the transcription initiation site, but they may be located within the coding region of the gene, in introns. HREs were defined by the strategy illustrated in Figure 38–11. The consensus sequences illustrated in Table 42–1

were arrived at through analysis of many genes regulated by a given hormone using simple, heterologous reporter systems (see Figure 38–10). Although these simple HREs bind the hormone-receptor complex more avidly than surrounding DNA—or DNA from an unrelated source—and confer hormone responsiveness to a reporter gene, it soon became apparent that the regulatory circuitry of natural genes must be much more complicated. Glucocorticoids, progestins, mineralocorticoids, and androgens have vastly different physiologic actions. How could the specificity required for these effects be achieved through regulation of gene expression by the same HRE (Table 42–1)? Questions like this have led to experiments which have allowed for elaboration of a very complex model of transcription regulation. For example, the HRE must associate with other DNA elements (and associated binding proteins) to function optimally. The extensive sequence similarity noted between steroid hormone receptors, particularly in their DNA-binding domains (DBD), led to discovery of the **nuclear receptor superfamily** of proteins. These—and a large number of **coregulator proteins**—allow for a wide variety of DNA–protein and protein–protein interactions and the specificity necessary for highly regulated physiologic control. A schematic of such an assembly is illustrated in **Figure 42–11**.

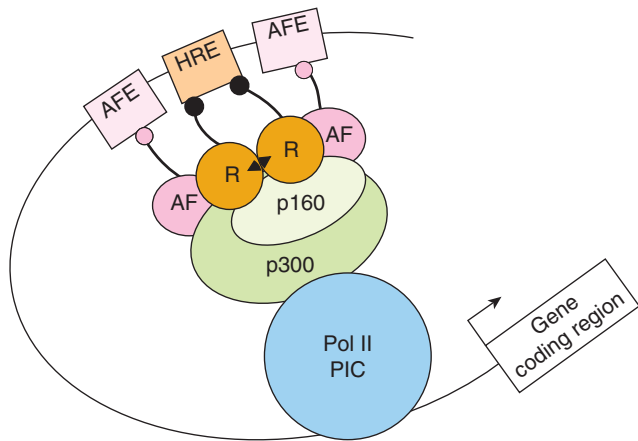

FIGURE 42-11 The hormone response transcription unit.

The hormone response transcription unit is an assembly of DNA elements and complementary, cognate DNA-bound proteins that interact, through protein–protein interactions, with a number of coactivator or corepressor molecules. An essential component is the hormone response element that binds the ligand (\blacktriangle)-bound receptor (R). Also important are the accessory factor elements (AFEs) with bound transcription factors. More than two dozen of these accessory factors (AFs), which are often members of the nuclear receptor superfamily, have been linked to hormone effects on transcription. The AFs can interact with each other, with the liganded nuclear receptors, or with coregulators. These components communicate with the basal transcription machinery, forming the Polymerase II PIC (ie, RNAP II and GTFs; Figure 36–10) through a coregulator complex that can consist of one or more members of the p160, corepressor, mediator-related, or CBP/p300 families (see Table 42–6). Recall (Chapters 36, 38) that many of the transcription coregulators carry intrinsic enzymatic activities that covalently modify the DNA, transcription proteins, and the histones present in the nucleosomes (not shown here) in and around the enhancer (HRE, AFE) and promoter. Collectively the hormone, hormone receptor, chromatin, DNA and transcription machinery integrate and process hormone signals to regulate transcription in a physiological fashion.

There Is a Large Family of Nuclear Receptor Proteins

The nuclear receptor superfamily consists of a diverse set of transcription factors that were discovered because of a sequence similarity in their DBDs. This family, now with >50 members, includes the nuclear hormone receptors discussed above, a number of other receptors whose ligands were discovered after the receptors were identified, and many putative or orphan receptors for which a ligand has yet to be discovered.

These nuclear receptors have several common structural features (Figure 42–12). All have a centrally located DBD that allows the receptor to bind with high affinity to a response element. The DBD contains two zinc finger binding motifs (see Figure 38–14) that direct binding either as homodimers, as heterodimers (usually with a retinoid X receptor [RXR] partner), or as monomers. The target response element consists of one or two DNA half-site consensus sequences arranged as an inverted or direct repeat. The spacing between the latter helps determine binding specificity. Thus, in general, a direct

repeat with three, four, or five nucleotide spacer regions specifies the binding of the vitamin D, thyroid, and retinoic acid receptors, respectively, to the same consensus response element (Table 42–1). A multifunctional **ligand-binding domain (LBD)** is located in the carboxyl terminal half of the receptor. The LBD binds hormones or metabolites with selectivity and thus specifies a particular biologic response. The LBD also contains domains that mediate the binding of heat shock proteins, dimerization, nuclear localization, and transactivation. The latter function is facilitated by the carboxyl terminal transcription activation function (**AF-2 domain**), which forms a surface required for the interaction with coactivators. A highly variable **hinge region** separates the DBD from the LBD. This region provides flexibility to the receptor, so it can assume different DNA-binding conformations. Finally, there is a highly variable amino terminal region that contains another transactivation domain referred to as **AF-1**. The AF-1 domain likely provides for distinct physiologic functions through the binding of different coregulator proteins. This region of the receptor, through the use of different promoters, alternative splice sites, and multiple translation initiation sites, provides for receptor isoforms that share DBD and LBD identity but exert different physiologic responses because of the association of various coregulators with this variable amino terminal AF-1 domain.

It is possible to sort this large number of receptors into groups in a variety of ways. Here, they are discussed according to the way they bind to their respective DNA elements (Figure 42–12). Classic hormone receptors for glucocorticoids (GR), mineralocorticoids (MR), estrogens (ER), and androgens (AR), and progestins (PR) bind as homodimers to inverted repeat sequences. Other hormone receptors such as thyroid (TR), retinoic acid (RAR), and vitamin D (VDR) and receptors that bind various metabolite ligands such as PPAR α , β , and γ , FXR, LXR, PXR/SXR, and CAR bind as heterodimers, with retinoid X receptor (RXR) as a partner, to direct repeat sequences (see Figure 42–12 and Table 42–5). Another group of orphan receptors that as yet have no known ligand bind as homodimers or monomers to direct repeat sequences.

As illustrated in Table 42–5, the discovery of the nuclear receptor superfamily has led to an important understanding of how a variety of metabolites and xenobiotics regulate gene expression and thus the metabolism, detoxification, and elimination of normal body products and exogenous agents such as pharmaceuticals. Not surprisingly, this area is a fertile field for investigation of new therapeutic interventions.

A Large Number of Nuclear Receptor Coregulators Also Participate in Regulating Transcription

Chromatin remodeling (histone modifications, DNA methylation), transcription factor modification by various enzyme activities, and the communication between the nuclear receptors and the basal transcription apparatus are accomplished by protein–protein interactions with one or more of a class

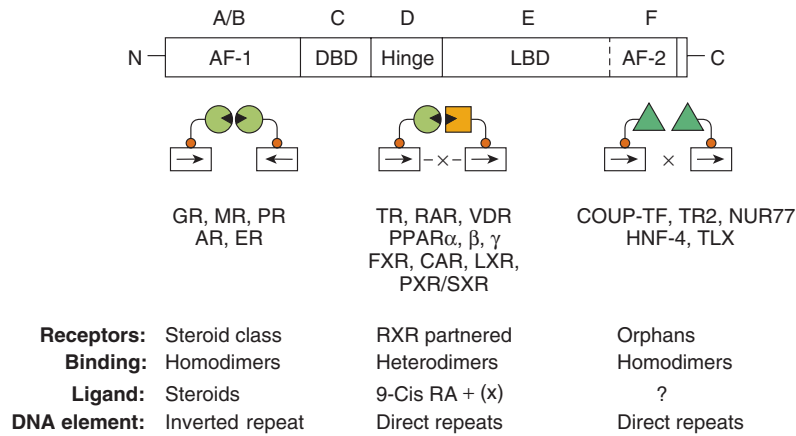

FIGURE 42-12 The nuclear receptor superfamily. Members of this family are divided into six structural domains (A–F). Domain A/B is also called AF-1, or the modulator region, because it is involved in activating transcription. The C domain consists of the DNA-binding domain (DBD). The D region contains the hinge, which provides flexibility between the DBD and the ligand-binding domain (LBD, region E). The C-terminal part of region E contains AF-2, another domain important for activation of transcription. The F region is poorly defined. The functions of these domains are discussed in more detail in the text. Receptors with known ligands, such as the steroid hormones, bind as homodimers on inverted repeat half-sites. Other receptors form heterodimers with the partner RXR on direct repeat elements. There can be nucleotide spacers of one to five bases between these direct repeats (DR1–5). Another class of receptors for which ligands have not been definitively determined (orphan receptors) bind as homodimers to direct repeats and occasionally as monomers to a single half-site.

TABLE 42-5 Nuclear Receptors With Special Ligands^a

Receptor	Partner	Ligand	Process Affected	
Peroxisome	PPAR _α	RXR (DR1)	Fatty acids	Peroxisome proliferation
Proliferator-activated	PPAR _β		Fatty acids	Lipid and carbohydrate metabolism
	PPAR _γ		Fatty acids Eicosanoids, thiazolidinediones	
Farnesoid X	FXR	RXR (DR4)	Farnesol, bile acids	Bile acid metabolism
Liver X	LXR	RXR (DR4)	Oxysterols	Cholesterol metabolism
Xenobiotic X	CAR	RXR (DR5)	Androstanes Phenobarbital Xenobiotics	Protection against certain drugs, toxic metabolites, and xenobiotics
	PXR	RXR (DR3)	Pregnanes Xenobiotics	

^aMany members of the nuclear receptor superfamily were discovered by cloning, and the corresponding ligands were subsequently identified. These ligands are not hormones in the classic sense, but they do have a similar function in that they activate specific members of the nuclear receptor superfamily. The receptors described here form heterodimers with RXR and have variable nucleotide sequences separating the direct repeat binding elements (DR1-5). These receptors regulate a variety of genes encoding cytochrome p450s (CYP), cytosolic binding proteins, and ATP-binding cassette (ABC) transporters to influence metabolism and protect cells against drugs and noxious agents.

of coregulator molecules. The number of these coregulator molecules now exceeds 100, not counting species variations and splice variants. The first of these to be described was the **CREB-binding protein, CBP**. CBP, through an amino terminal domain, binds to phosphorylated serine 137 of CREB and mediates transactivation in response to cAMP. It thus is described as a coactivator. CBP and its close relative, p300, interact directly or indirectly with a number of signaling

molecules, including activator protein-1 (AP-1), STATs, nuclear receptors, and CREB (**Figure 42-13**). **CBP/p300** also binds to the p160 family of coactivators described below and to a number of other proteins, including viral transcription factor Ela, the p90^{rsk} protein kinase, and RNA helicase A. It is important to note, as mentioned above, that **CBP/p300 also has intrinsic histone acetyltransferase (HAT) activity**. Some of the many actions of CBP/p300, which appear to depend on

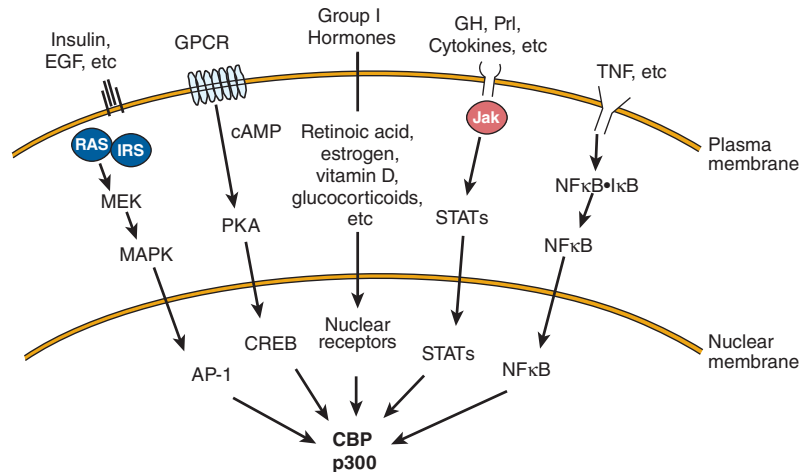

FIGURE 42-13 Several signal transduction pathways converge on CBP/p300. Many ligands that associate with membrane or nuclear receptors eventually converge on CBP/p300. Several different signal transduction pathways are employed. (EGF, epidermal growth factor; GH, growth hormone; Prl, prolactin; TNF, tumor necrosis factor; other abbreviations are expanded in the text.)

intrinsic enzyme activities and its ability to serve as a scaffold for the binding of other proteins, are illustrated in Figure 42-11. Other coregulators serve similar functions.

Several other families of coactivator molecules have been described. Members of the **p160 family of coactivators**, all of about 160 kDa, include (1) SRC-1 and NCoA-1; (2) GRIP 1, TIF2, and NCoA-2; and (3) p/CIP, ACTR, AIB1, RAC3, and TRAM-1 (Table 42-6). The different names for members within a subfamily often represent species variations or minor splice variants. There is about 35% amino acid identity between members of the different subfamilies. The p160 coactivators share several properties. They (1) bind nuclear receptors in an agonist- and AF-2 transactivation domain-dependent manner, (2) have a conserved amino terminal basic helix-loop-helix (bHLH) motif (see Chapter 38), (3) have a weak carboxyl terminal transactivation domain and a stronger amino terminal transactivation domain in a region that is required for CBP-p160 interaction, (4) contain at least three of the **LXXLL motifs** required for protein-protein interaction with other coactivators, and (5) often have HAT activity. The role of HAT is particularly interesting, as mutations of the HAT domain disable many of these transcription factors. Current thinking holds that these HAT activities acetylate histones, which facilitates the remodeling of chromatin into a transcription-efficient environment. Histone acetylation/deacetylation thus plays a critical role in gene expression. Finally, it is important to note that other protein substrates for HAT-mediated acetylation, such as DNA binding transcription activators and other coregulators have been reported. Such nonhistone PTM events likely also factor importantly into the overall regulatory response.

A small number of proteins, including NCoR and SMRT, comprise the **corepressor family**. They function, at least in part, as described in Figure 42-2. Another family includes the

TABLE 42-6 Some Mammalian Coregulator Proteins

I. 300-kDa family of coactivators	
A. CBP	CREB-binding protein
B. p300	Protein of 300 kDa
II. 160-kDa family of coactivators	
A. SRC-1,2,3	Steroid receptor coactivator 1, 2 and 3
NCoA-1	Nuclear receptor coactivator 1
B. TIF2	Transcriptional intermediary factor 2
GRIP1	Glucocorticoid receptor-interacting protein
NCoA-2	Nuclear receptor coactivator 2
C. p/CIP	p300/CBP cointegrator-associated protein 1
ACTR	Activator of the thyroid and retinoic acid receptors
AIB	Amplified in breast cancer
RAC3	Receptor-associated coactivator 3
TRAM-1	TR activator molecule 1
III. Corepressors	
A. NCoR	Nuclear receptor corepressor
B. SMRT	Silencing mediator for RXR and TR
IV. Mediator subunits	
A. TRAPs	Thyroid hormone receptor-associated proteins
B. DRIPs	Vitamin D receptor-interacting proteins
C. ARC	Activator-recruited cofactor

TRAPs, DRIPs, and ARC (Table 42–6). These proteins represent subunits of the Mediator (see Chapter 36) and range in size from 80 to 240 kDa and are thought to link the nuclear receptor-coactivator complex to RNA polymerase II and the other components of the basal transcription apparatus.

The exact role of these coactivators is presently under intensive investigation. Many of these proteins have intrinsic enzymatic activities. This is particularly interesting in view of the fact that acetylation, phosphorylation, methylation, sumoylation, and ubiquitination—as well as proteolysis and cellular translocation—have been proposed to alter the activity of some of these coregulators and their targets.

It appears that certain combinations of coregulators—and thus different combinations of activators and inhibitors—are responsible for specific ligand-induced actions through various receptors. Furthermore, these interactions on a given promoter are dynamic. In some cases, complexes consisting of over 45 transcription factors have been observed on a single gene.

SUMMARY

- Hormones, cytokines, interleukins, and growth factors use a variety of signaling mechanisms to facilitate cellular adaptive responses.
- The ligand-receptor complex serves as the initial signal for members of the nuclear receptor family.
- Class II peptide/protein and catecholamine hormones, which bind to cell surface receptors, generate a variety of intracellular signals. These include cAMP, cGMP, Ca²⁺, phosphatidylinositides, and protein kinase cascades.
- Many hormone responses are accomplished through alterations in the rate of transcription of specific genes.
- The nuclear receptor superfamily of proteins plays a central role in the regulation of gene transcription.
- Nuclear receptors, which may have hormones, metabolites, or drugs as ligands, bind to specific DNA elements as homodimers or as heterodimers with RXR. Some—orphan receptors—have no known ligand but bind DNA and influence transcription.
- Another large family of coregulator proteins remodel chromatin, modify other transcription factors, and bridge the nuclear receptors to the basal transcription apparatus.

REFERENCES

- Ahmadian M, Suh JM, Hah N, et al: PPAR γ signaling and metabolism: the good, the bad and the future. *Nat Med* 2013;19:557–566.
- Arvanitakis L, Geras-Raaka E, Gershengorn MC: Constitutively signaling G-protein-coupled receptors and human disease. *Trends Endocrinol Metab* 1998;9:27.
- Beene DL, Scott JD: A-kinase anchoring proteins take shape. *Current Opinion in Cell Biol* 2007;19:192.
- Brummer T, Schmitz-Perffer C, Daly RJ: Docking proteins. *FEBS Journal* 2010; 277:4356–4369.
- Cheung E, Kraus WL: Genomic analyses of hormone signaling and gene regulation. *Annu Rev Physiol* 2010;72:191–218.
- Darnell JE Jr, Kerr IM, Stark GR: Jak-STAT pathways and transcriptional activation in response to IFNs and other extracellular signaling proteins. *Science* 1994;264:1415.
- Dasgupta S, Lonard DM, O'Malley BW: Nuclear receptor coactivators: master regulators of human health and disease. *Annu Rev Med* 2014;65:279–292.
- Fantl WJ, Johnson DE, Williams LT: Signalling by receptor tyrosine kinases. *Annu Rev Biochem* 1993;62:453.
- Hanoune J, Defer N: Regulation and role of adenylyl cyclase isoforms. *Annu Rev Pharmacol Toxicol* 2001;41:145.
- Jaken S: Protein kinase C isozymes and substrates. *Curr Opin Cell Biol* 1996;8:168.
- Kobilka BK: Structural insights into adrenergic receptor function and pharmacology. *Trends Pharmacol Sci.* 2011;32:213–218.
- Lee C-H, Olson P, Evans RM: Mini-review: lipid metabolism, metabolic diseases and peroxisome proliferators-activated receptor. *Endocrinology* 2003;144:2201.
- Métivier R, Gallais R, Tiffocche C, et al: Cyclical DNA methylation of a transcriptionally active promoter. *Nature* 2008;452:45.
- Métivier R, Reid G, Gannon F: Transcription in four dimensions: nuclear receptor-directed initiation of gene expression. *EMBO Journal* 2006;7:161.
- Montminy M: Transcriptional regulation by cyclic AMP. *Annu Rev Biochem* 1997;66:807.
- Morris AJ, Malbon CC: Physiological regulation of G protein-linked signaling. *Physiol Rev* 1999;79:1373.
- O'Malley B: Coregulators: from whence came these “master genes.” *Mol Endocrinology* 2007;21:1009.
- Ratman D, Vanden Berghe W, Dejager, L et al: How glucocorticoid receptors modulate the activity of other transcription factors: a scope beyond tethering. *Mol Cell Endocrinol.* 2013;380:41–54.
- Reiter E, Ahn S, Shukla AK: Molecular mechanism of β -arrestin-biased agonism at seven-transmembrane receptors. *Annu Rev Pharmacol Toxicol.* 2012;52:179–197.
- Rosenfeld MG, Lunyak VV, Glass CK: Sensors and signals: a coactivator/corepressor/epigenetic code for integrating signal-dependent programs of transcriptional response. *Genes and Dev* 2006;20:1405.
- Sonoda J, Pei L, Evans RM: Nuclear receptors: decoding metabolic disease. *Fed of European Biochem Soc* 2007;582:2.
- Spiegelman BM: Banting Lecture 2012: Regulation of adipogenesis: toward new therapeutics for metabolic disease. *Diabetes* 2013;62:1774–1782.
- Tang X, Tang G, Ozcan S: Role of microRNAs in diabetes. *Biochim Biophys Acta* 2008;1779:697.
- Telese F, Gamliel A, Skowronska-Krawczyk D: “Seq-ing” insights into the epigenetics of neuronal gene regulation. *Neuron* 2013;77:606–623.
- Walton KM, Dixon JE: Protein tyrosine phosphatases. *Annu Rev Biochem* 1993;62:101.

Exam Questions

Section VIII – Biochemistry of Extracellular & Intracellular Communication

- Regarding membrane lipids, select the one FALSE answer.
 - The major phospholipid by mass in human membranes is generally phosphatidylcholine.
 - Glycolipids are located on the inner and outer leaflets of the plasma membrane.
 - Phosphatidic acid is a precursor of phosphatidylserine, but not of sphingomyelin.
 - Phosphatidylcholine and phosphatidylethanolamine are located primarily on the outer leaflet of the plasma membrane.
 - The flip-flop of phospholipids in membranes is very slow.
- Regarding membrane proteins, select the one FALSE answer.
 - Because of steric considerations, alpha-helices cannot exist in membranes.
 - A hydrophathy plot helps one to estimate whether a segment of a protein is predominantly hydrophobic or hydrophilic.
 - Certain proteins are anchored to the outer leaflet of plasma membranes via glycosylphosphatidylinositol (GPI) structures.
 - Adenylyl cyclase is a marker enzyme for the plasma membrane.
 - Myelin has a very high content of lipid compared with protein.
- Regarding membrane transport, select the one FALSE statement.
 - Potassium has a lower charge density than sodium and tends to move more quickly through membranes than does sodium.
 - The flow of ions through ion channels is an example of passive transport.
 - Facilitated diffusion requires a protein transporter.
 - Inhibition of the Na^+/K^+ -ATPase will inhibit sodium-dependent uptake of glucose in intestinal cells.
 - Insulin, by recruiting glucose transporters to the plasma membrane, increases uptake of glucose in fat cells but not in muscle.
- Regarding the Na^+/K^+ -ATPase, select the one FALSE statement.
 - Its action maintains the high intracellular concentration of sodium compared with potassium.
 - It can use as much as 30% of the total ATP expenditure of a cell.
 - It is inhibited by digitalis, a drug that is useful in certain cardiac conditions.
 - It is located in the plasma membrane of cells.
 - Phosphorylation is involved in its mechanism of action, leading to its classification as a P-type ATP-driven active transporter.
- What molecules enable cells to respond to a specific extracellular signaling molecule?
 - Specific receptor carbohydrates localized to the inner plasma membrane surface
 - Plasma lipid bilayer
 - Ion channels
 - Receptors that specifically recognize and bind that particular messenger molecule
 - Intact nuclear membranes
- Indicate the term generally applied to the extracellular messenger molecules that bind to transmembrane receptor proteins:
 - Competitive inhibitor
 - Ligand
 - Scatchard curve
 - Substrate
 - Key
- In autocrine signaling:
 - Messenger molecules reach their target cells via passage through bloodstream.
 - Messenger molecules travel only short distances through the extracellular space to cells that are in close proximity to the cell that is generating the message.
 - The cell producing the messenger expresses receptors on its surface that can respond to that messenger.
 - The messenger molecules are usually rapidly degraded and hence can only work over short distances.
- Regardless of how a signal is initiated, the ligand-binding event is propagated via second messengers or protein recruitment. What is the ultimate, or final biochemical outcome of these binding events?
 - A protein in the middle of an intracellular signaling pathway is activated.
 - A protein at the bottom of an intracellular signaling pathway is activated.
 - A protein at the top of an extracellular signaling pathway is activated.
 - A protein at the top of an intracellular signaling pathway is deactivated.
 - A protein at the top of an intracellular signaling pathway is activated.
- What features of the nuclear receptor superfamily suggest that these proteins have evolved from a common ancestor?
 - They all bind the same ligand with high affinity.
 - They all function within the nucleus.
 - They are all subject to regulatory phosphorylation.
 - They all contain regions of high amino acid sequence similarity/identity.
 - They all bind DNA.
- What effect does degradation of receptor-ligand complexes after internalization have upon the ability of a cell to respond if immediately reexposed to the same hormone?
 - The cellular response is attenuated due to a decrease in cellular receptor number.
 - Cellular response is enhanced due to reduced receptor-ligand competition.
 - The cellular response is unchanged to subsequent stimuli.
 - Cell hormone response is now bimodal; enhanced for a short time and thereafter inactivated.

11. Typically, what is the first reaction after most receptor protein-tyrosine kinases (RTKs) bind their ligand?
- Receptor trimerization
 - Receptor degradation
 - Receptor denaturation
 - Receptor dissociation
 - Receptor dimerization
12. Where is the kinase catalytic domain of the receptor protein-tyrosine kinases found?
- On the extracellular surface of the receptor, immediately adjacent to the ligand binding domain.
 - On the cytoplasmic domain of the receptor.
 - On an independent protein that rapidly binds the receptor upon ligand binding.
 - Within the transmembrane spanning portion of the receptor.
13. The subunits of the heterotrimeric G proteins are called the __, __, and __ subunits.
- α , β , and χ
 - α , β , and δ
 - α , γ , and δ
 - α , β , and γ
 - γ , δ , and η
14. Of the receptors listed below, which can conduct a flow of ions across the plasma membrane when bound to their cognate ligand?
- Receptor tyrosine kinases (RTKs)
 - G protein-coupled receptors (GPCRs)
 - G protein coupled receptors
 - Steroid hormone receptors
 - Ligand-gated channels
15. Which of the following is NOT a natural ligand that binds to G protein-coupled receptors?
- Hormones
 - Steroid hormones
 - Chemoattractants
 - Opium derivatives
 - Neurotransmitters
16. Place the events of signaling listed below in the CORRECT order.
- G protein binds to activated receptor forming a receptor-G protein complex.
 - Release of GDP by the G protein.
 - Change in conformation of the cytoplasmic loops of the receptor.
 - Binding of GTP by the G protein.
 - Increase in the affinity of the receptor for a G protein on the cytoplasmic surface of the membrane.
 - Binding of a hormone or neurotransmitter to a G protein-coupled receptor.
 - Conformational shift in the α subunit of the G protein.
- 6 - 3 - 5 - 1 - 2 - 4 - 7
 - 6 - 5 - 4 - 1 - 7 - 2 - 3
 - 6 - 3 - 5 - 1 - 7 - 2 - 4
 - 6 - 7 - 3 - 5 - 1 - 2 - 4
 - 6 - 3 - 5 - 4 - 7 - 2 - 1
17. Which heterotrimeric G proteins couple receptors to adenylyl cyclase via the activation of GTP-bound G_α subunits?
- G_s family
 - G_q family
 - G_i family
 - $G_{12/13}$ family
 - G_x family
18. What must happen in order to prevent overstimulation by a hormone?
- Hormones must be degraded.
 - G proteins must be recycled and then degraded.
 - Receptors must be blocked from continuing to activate G proteins.
 - Receptors must dimerize.
19. Which of the following hormones termed the "flight-or-fight" hormone is secreted by the adrenal medulla?
- Epinephrine
 - Oxytocin
 - Insulin
 - Glucagon
 - Somatostatin
20. Which hormone is secreted by α -cells in the pancreas in response to low blood glucose levels?
- Insulin
 - Glucagon
 - Estradiol
 - Epinephrine
 - Somatostatin
21. In liver cells the expression of genes encoding gluconeogenic enzymes such as phosphoenolpyruvate carboxykinase is induced in response to which of the following molecules?
- cGMP
 - Insulin
 - ATP
 - cAMP
 - Cholesterol
22. What happens to protein kinase A (PKA) following the binding of cAMP?
- The regulatory subunits of PKA dissociate, thereby activating the catalytic subunits.
 - PKA catalytic subunits then bind to two regulatory subunits, thereby activating the catalytic subunits.
 - The inhibitory regulatory subunits dissociate from the catalytic subunits, completely inactivating the enzyme.
 - The stimulatory regulatory subunits dissociate from the catalytic subunits, inhibiting the enzyme.
 - Phosphodiesterase binds to the catalytic subunits, which results in enzyme inactivation.

This page intentionally left blank

Nutrition, Digestion, & Absorption

David A. Bender, PhD & Peter A. Mayes , PhD, DSc

OBJECTIVES

After studying this chapter,
you should be able to:

- Describe the digestion and absorption of carbohydrates, lipids, proteins, vitamins, and minerals.
- Explain how energy requirements can be measured and estimated and how measuring the respiratory quotient permits estimation of the mix of metabolic fuels being oxidized.
- Describe the consequences of undernutrition: marasmus, cachexia, and kwashiorkor.
- Explain how protein requirements are determined and why more of some proteins than others are required to maintain nitrogen balance.

BIOMEDICAL IMPORTANCE

In addition to water, the diet must provide metabolic fuels (mainly carbohydrates and lipids), protein (for growth and turnover of tissue proteins, as well as a source of metabolic fuel), fiber (for bulk in the intestinal lumen), minerals (containing elements with specific metabolic functions), and vitamins and essential fatty acids (organic compounds needed in smaller amounts for other metabolic and physiologic functions). The polysaccharides, triacylglycerols, and proteins that make up the bulk of the diet must be hydrolyzed to their constituent monosaccharides, fatty acids, and amino acids, respectively, before absorption and utilization. Minerals and vitamins must be released from the complex matrix of food before they can be absorbed and utilized.

Globally, **undernutrition** is widespread, leading to impaired growth, defective immune system, and reduced work capacity. By contrast, in developed countries, and increasingly in developing countries, there is excessive food consumption (especially of fat), leading to obesity, and the

development of diabetes, cardiovascular disease, and some cancers. Worldwide, there are more overweight and obese people than undernourished people. Deficiencies of vitamin A, iron, and iodine pose major health concerns in many countries, and deficiencies of other vitamins and minerals are a major cause of ill health. In developed countries nutrient deficiency is rare, although there are vulnerable sections of the population at risk. Intakes of minerals and vitamins that are adequate to prevent deficiency may be inadequate to promote optimum health and longevity.

Excessive secretion of gastric acid, associated with *Helicobacter pylori* infection, can result in the development of gastric and duodenal **ulcers**; small changes in the composition of bile can result in crystallization of cholesterol as **gallstones**; failure of exocrine pancreatic secretion (as in **cystic fibrosis**) leads to undernutrition and steatorrhea. **Lactose intolerance** is the result of lactase deficiency, leading to diarrhea and intestinal discomfort when lactose is consumed. Absorption of intact peptides that stimulate antibody responses causes **allergic reactions**; **celiac disease** is an allergic reaction to wheat gluten.

DIGESTION & ABSORPTION OF CARBOHYDRATES

The digestion of carbohydrates is by hydrolysis to liberate oligosaccharides, then free mono- and disaccharides. The increase in blood glucose after a test dose of a carbohydrate compared with that after an equivalent amount of glucose (as glucose or from a reference starchy food) is known as the **glycemic index**. Glucose and galactose have an index of 1 (or 100%), as do lactose, maltose, isomaltose, and trehalose, which give rise to these monosaccharides on hydrolysis. Fructose and the sugar alcohols are absorbed less rapidly and have a lower glycemic index, as does sucrose. The glycemic index of starch varies between near 1 (or 100%) and near 0 as a result of variable rates of hydrolysis, and that of nonstarch polysaccharides (see Figure 15–13) is 0. Foods that have a low glycemic index are considered to be more beneficial since they cause less fluctuation in insulin secretion. Resistant starch and nonstarch polysaccharides provide substrates for bacterial fermentation in the large intestine, and the resultant butyrate and other short chain fatty acids provide a significant source of fuel for intestinal enterocytes. There is evidence that butyrate also has antiproliferative activity, and so provides protection against colorectal cancer.

Amylases Catalyze the Hydrolysis of Starch

The hydrolysis of starch is catalyzed by salivary and pancreatic amylases, which catalyze random hydrolysis of $\alpha(1 \rightarrow 4)$ glycoside bonds, yielding dextrans, then a mixture of glucose, maltose, and maltotriose and small branched dextrans (from the branchpoints in amylopectin, Figure 15–12).

Disaccharidases Are Brush Border Enzymes

The disaccharidases, maltase, sucrase-isomaltase (a bifunctional enzyme catalyzing hydrolysis of sucrose and isomaltose), lactase, and trehalase are located on the brush border of the intestinal mucosal cells, where the resultant monosaccharides and those arising from the diet are absorbed. Congenital deficiency of lactase occurs rarely in infants, leading to lactose intolerance and failure to thrive when fed on breast milk or normal infant formula. Congenital deficiency of sucrase-isomaltase occurs among the Inuit, leading to sucrose intolerance, with persistent diarrhea and failure to thrive when the diet contains sucrose.

In most mammals, and most human beings, lactase activity begins to fall after weaning and is almost completely lost by late adolescence, leading to **lactose intolerance**. Lactose remains in the intestinal lumen, where it is a substrate for bacterial fermentation to lactate, resulting in abdominal discomfort and diarrhea after consumption of relatively large amounts. In two population groups, people of north European origin and nomadic tribes of sub-Saharan Africa and Arabia, lactase persists after weaning and into adult life. Marine mammals

secrete a high-fat milk that contains no carbohydrate, and their pups lack lactase.

There Are Two Separate Mechanisms for the Absorption of Monosaccharides in the Small Intestine

Glucose and galactose are absorbed by a sodium-dependent process. They are carried by the same transport protein (SGLT 1) and compete with each other for intestinal absorption (Figure 43–1). Other monosaccharides are absorbed by carrier-mediated diffusion. Because they are not actively transported, fructose and sugar alcohols are only absorbed down their concentration gradient, and after a moderately high intake, some may remain in the intestinal lumen, acting as a substrate for bacterial fermentation. Large intakes of fructose and sugar alcohols can lead to osmotic diarrhea.

DIGESTION & ABSORPTION OF LIPIDS

The major lipids in the diet are triacylglycerols and, to a lesser extent, phospholipids. These are hydrophobic molecules and have to be hydrolyzed and emulsified to very small droplets

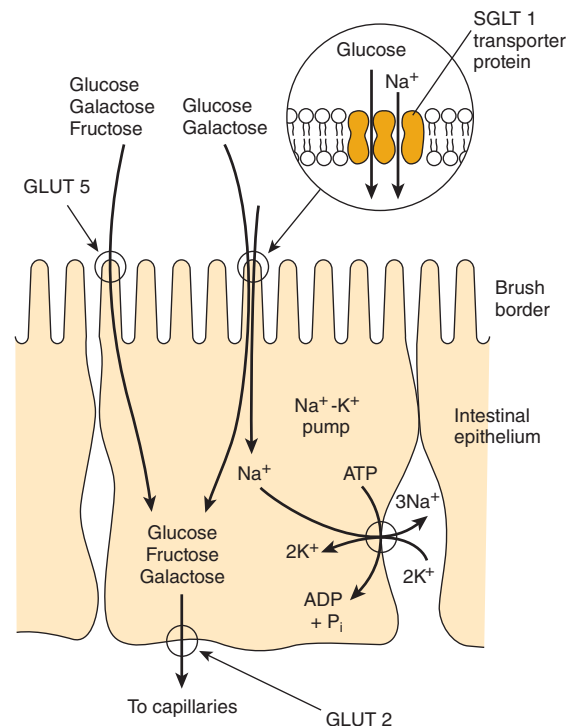

FIGURE 43–1 Transport of glucose, fructose, and galactose across the intestinal epithelium. The SGLT 1 transporter is coupled to the Na⁺-K⁺ pump, allowing glucose and galactose to be transported against their concentration gradients. The GLUT 5 Na⁺-independent facilitative transporter allows fructose, as well as glucose and galactose, to be transported down their concentration gradients. Exit from the cell for all sugars is via the GLUT 2 facilitative transporter.

(micelles, 4-6 nm in diameter) before they can be absorbed. The fat-soluble vitamins, A, D, E, and K, and a variety of other lipids (including cholesterol and carotenes) are absorbed dissolved in the lipid micelles. Absorption of carotenes and fat-soluble vitamins is impaired on a very low fat diet.

Hydrolysis of triacylglycerols is initiated by lingual and gastric lipases, which attack the *sn*-3 ester bond forming 1,2-diacylglycerols and free fatty acids, which act as emulsifying agents. Pancreatic lipase is secreted into the small intestine and requires a further pancreatic protein, colipase, for activity. It is specific for the primary ester links—ie, positions 1 and 3 in triacylglycerols—resulting in 2-monoacylglycerols and free fatty acids as the major end products of luminal triacylglycerol digestion. Inhibitors of pancreatic lipase are used to inhibit triacylglycerol hydrolysis in the treatment of severe obesity. Pancreatic esterase in the intestinal lumen hydrolyzes monoacylglycerols, but they are poor substrates, and only ~25% of ingested triacylglycerol is completely hydrolyzed to glycerol and fatty acids before absorption (**Figure 43–2**). Bile salts, formed in the liver and secreted in the bile, permit emulsification of the products of lipid digestion into micelles together with dietary phospholipids and cholesterol secreted in the bile (about 2 g/d) as well as dietary cholesterol (about 0.5 g/d). Micelles are less than 1 μm in diameter, and soluble, so they allow the products of digestion, including the fat-soluble vitamins, to be transported through the aqueous environment of the intestinal lumen to come into close contact with the brush border of the mucosal cells, allowing uptake into the epithelium. The bile salts remain in the intestinal lumen, where most are absorbed from the ileum into the **enterohepatic circulation** (see Chapter 26).

Within the intestinal epithelium, 1-monoacylglycerols are hydrolyzed to fatty acids and glycerol and 2-monoacylglycerols are reacylated to triacylglycerols via the **monoacylglycerol pathway**. Glycerol released in the intestinal lumen is absorbed into the hepatic portal vein; glycerol released within the epithelium is reutilized for triacylglycerol synthesis via the normal phosphatidic acid pathway (see Chapter 24). Long-chain fatty acids are esterified to yield to triacylglycerol in the mucosal cells and together with the other products of lipid digestion, secreted as chylomicrons into the lymphatics, entering the bloodstream via the thoracic duct (see Chapter 25). Short- and medium-chain fatty acids are mainly absorbed into the hepatic portal vein as free fatty acids.

Cholesterol is absorbed dissolved in lipid micelles and is mainly esterified in the intestinal mucosa before being incorporated into chylomicrons. Plant sterols and stanols (in which the B ring is saturated) compete with cholesterol for esterification, but are poor substrates, so that there is an increased amount of unesterified cholesterol in the mucosal cells. Unesterified cholesterol and other sterols are actively transported out of the mucosal cells into the intestinal lumen. This means that plant sterols and stanols effectively inhibit the absorption of not only dietary cholesterol, but also the larger amount that is secreted in the bile, so lowering the whole body cholesterol content, and hence the plasma cholesterol concentration.

DIGESTION & ABSORPTION OF PROTEINS

Native proteins are resistant to digestion because few peptide bonds are accessible to the proteolytic enzymes without prior denaturation of dietary proteins (by heat in cooking and by the action of gastric acid).

Several Groups of Enzymes Catalyze the Digestion of Proteins

There are two main classes of proteolytic digestive enzymes (**proteases**), with different specificities for the amino acids forming the peptide bond to be hydrolyzed. **Endopeptidases** hydrolyze peptide bonds between specific amino acids throughout the molecule. They are the first enzymes to act, yielding a larger number of smaller fragments. Pepsin in the gastric juice catalyzes hydrolysis of peptide bonds adjacent to amino acids with bulky side-chains (aromatic and branched-chain amino acids and methionine). Trypsin, chymotrypsin, and elastase are secreted into the small intestine by the pancreas. Trypsin catalyzes hydrolysis of lysine and arginine esters, chymotrypsin esters of aromatic amino acids, and elastase esters of small neutral aliphatic amino acids. **Exopeptidases** catalyze the hydrolysis of peptide bonds, one at a time, from the ends of peptides. **Carboxypeptidases**, secreted in the pancreatic juice, release amino acids from the free carboxyl terminal; **aminopeptidases**, secreted by the intestinal mucosal cells, release amino acids from the amino terminal. **Dipeptidases** and **tripeptidases** in the brush border of intestinal mucosal cells catalyze the hydrolysis of di- and tripeptides, which are not substrates for amino- and carboxypeptidases.

The proteases are secreted as inactive **zymogens**; the active site of the enzyme is masked by a small region of the peptide chain that is removed by hydrolysis of a specific peptide bond. Pepsinogen is activated to pepsin by gastric acid and by activated pepsin. In the small intestine, trypsinogen, the precursor of trypsin, is activated by enteropeptidase, which is secreted by the duodenal epithelial cells; trypsin can then activate chymotrypsinogen to chymotrypsin, proelastase to elastase, procarboxypeptidase to carboxypeptidase, and proaminopeptidase to aminopeptidase.

Free Amino Acids & Small Peptides Are Absorbed by Different Mechanisms

The end product of the action of endopeptidases and exopeptidases is a mixture of free amino acids, di- and tripeptides, and oligopeptides, all of which are absorbed. Free amino acids are absorbed across the intestinal mucosa by sodium-dependent active transport. There are several different amino acid transporters, with specificity for the nature of the amino acid side-chain (large or small, neutral, acidic, or basic). The various amino acids carried by any one transporter compete with each other for absorption and tissue uptake. Dipeptides and tripeptides enter the brush border of the intestinal mucosal

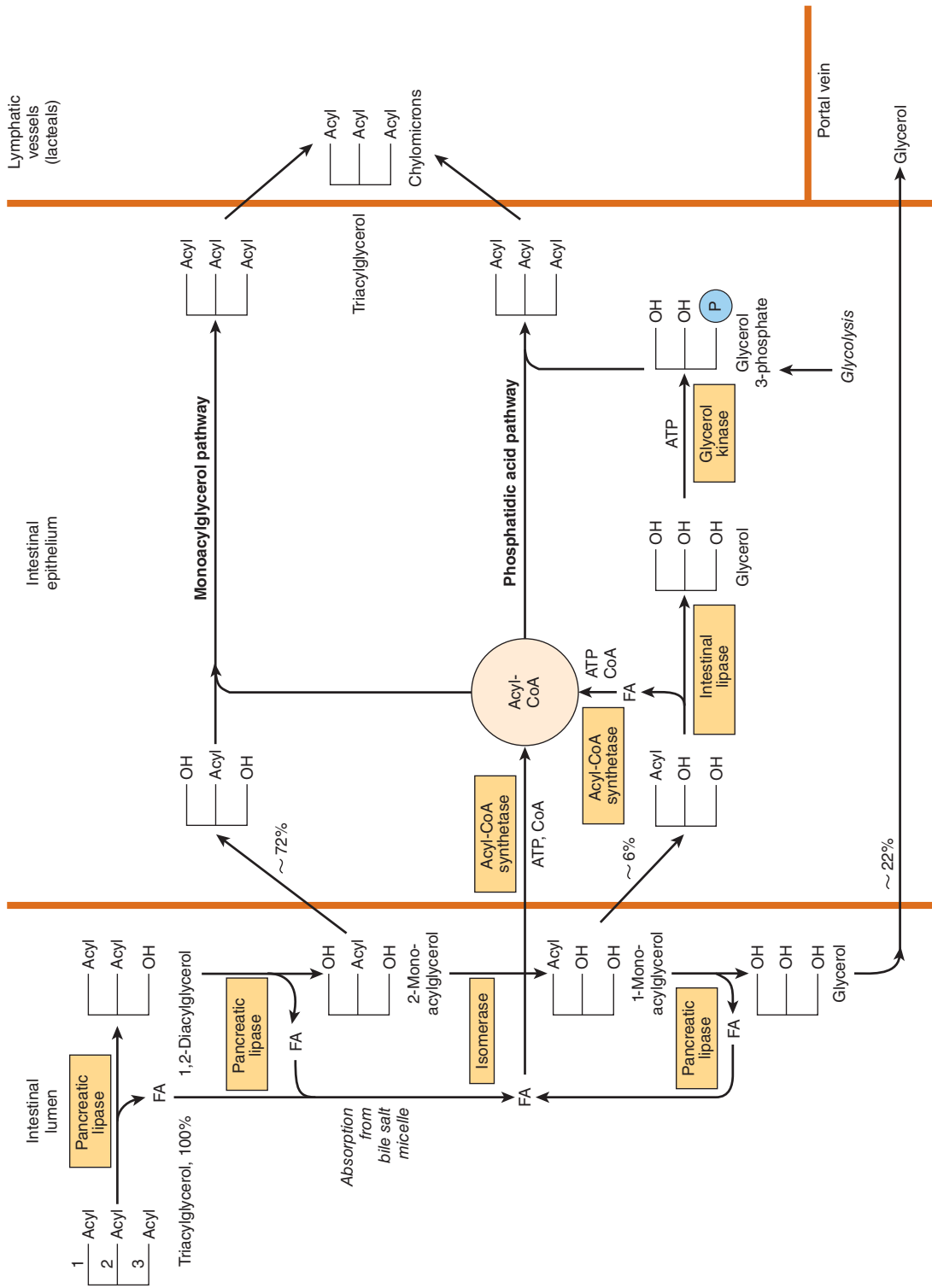

FIGURE 43-2 Digestion and absorption of triacylglycerols. The values given for percentage uptake may vary widely but indicate the relative importance of the three routes shown.

cells, where they are hydrolyzed to free amino acids, which are then transported into the hepatic portal vein. Relatively large peptides may be absorbed intact, either by uptake into mucosal epithelial cells (transcellular) or by passing between epithelial cells (paracellular). Many such peptides are large enough to stimulate antibody formation—this is the basis of **allergic reactions** to foods.

DIGESTION & ABSORPTION OF VITAMINS & MINERALS

Vitamins and minerals are released from food during digestion, although this is not complete, and the availability of vitamins and minerals depends on the type of food and, especially for minerals, the presence of chelating compounds. The fat-soluble vitamins are absorbed in the lipid micelles that are the result of fat digestion; water-soluble vitamins and most mineral salts are absorbed from the small intestine either by active transport or by carrier-mediated diffusion followed by binding to intracellular proteins to achieve concentrative uptake. Vitamin B₁₂ absorption requires a specific transport protein, intrinsic factor (see Chapter 44); calcium absorption is dependent on vitamin D; zinc absorption probably requires a zinc-binding ligand secreted by the exocrine pancreas, and the absorption of iron is limited (see below).

Calcium Absorption Is Dependent on Vitamin D

In addition to its role in regulating calcium homeostasis, vitamin D is required for the intestinal absorption of calcium. Synthesis of the intracellular calcium-binding protein, **calbindin**, required for calcium absorption, is induced by vitamin D. Vitamin D also acts to recruit calcium transporters to the cell surface, so increasing calcium absorption rapidly—a process that is independent of new protein synthesis.

Phytic acid (inositol hexaphosphate) in cereals binds calcium in the intestinal lumen, preventing its absorption. Other minerals, including zinc, are also chelated by phytate. This is mainly a problem among people who consume large amounts of unleavened whole-wheat products; yeast contains an enzyme, **phytase**, that dephosphorylates phytate, so rendering it inactive. High concentrations of fatty acids in the intestinal lumen, as a result of impaired fat absorption, can also reduce calcium absorption by forming insoluble calcium salts; a high intake of oxalate can sometimes cause deficiency since calcium oxalate is insoluble.

Iron Absorption Is Limited and Strictly Controlled, but Enhanced by Vitamin C and Alcohol

Although iron deficiency is a common problem in both developed and developing countries, about 10% of the population are genetically at risk of iron overload (**hemochromatosis**), and in order to reduce the risk of adverse effects of nonenzymic

generation of free radicals by iron salts, absorption is strictly regulated. Inorganic iron is transported into the mucosal cell by a proton-linked divalent metal ion transporter, and accumulated intracellularly by binding to **ferritin**. Iron leaves the mucosal cell via a transport protein ferroportin, but only if there is free **transferrin** in plasma to bind to. Once transferrin is saturated with iron, any that has accumulated in the mucosal cells is lost when the cells are shed. Expression of the ferroportin gene (and possibly also that for the divalent metal ion transporter) is downregulated by hepcidin, a peptide secreted by the liver when body iron reserves are adequate. In response to hypoxia, anemia, or hemorrhage, the synthesis of hepcidin is reduced, leading to increased synthesis of ferroportin and increased iron absorption (**Figure 43–3**). As a result of this mucosal barrier, only ~10% of dietary iron is absorbed, and only 1% to 5% from many plant foods.

Inorganic iron is absorbed in the Fe²⁺ (reduced) state, and hence, the presence of reducing agents enhances absorption. The most effective compound is **vitamin C**, and while intakes of 40 to 80 mg of vitamin C per day are more than adequate to meet requirements, an intake of 25 to 50 mg per meal enhances iron absorption, especially when iron salts are used to treat iron deficiency anemia. Alcohol and fructose also enhance iron absorption. Heme iron from meat is absorbed separately and is considerably more available than inorganic iron. However, the absorption of both inorganic and heme iron is impaired by calcium—a glass of milk with a meal significantly reduces iron availability.

ENERGY BALANCE: OVER- & UNDERNUTRITION

After the provision of water, the body's first requirement is for metabolic fuels—fats, carbohydrates, and amino acids from proteins (see Table 16–1). Food intake in excess of energy expenditure leads to **obesity**, while intake less than expenditure leads to emaciation and wasting, **marasmus**, and **kwashiorkor**. Both obesity and severe undernutrition are associated with increased mortality. The body mass index = weight (in kg)/height² (in m) is commonly used as a way of expressing relative obesity; a desirable range is between 20 and 25.

Energy Requirements Are Estimated by Measurement of Energy Expenditure

Energy expenditure can be determined directly by measuring heat output from the body, but is normally estimated indirectly from the consumption of oxygen. There is an energy expenditure of ~20 kJ/L of oxygen consumed, regardless of whether the fuel being metabolized is carbohydrate, fat, or protein (see Table 14–1).

Measurement of the ratio of the volume of carbon dioxide produced: volume of oxygen consumed (**respiratory quotient, RQ**) is an indication of the mixture of metabolic fuels being oxidized (see Table 14–1).

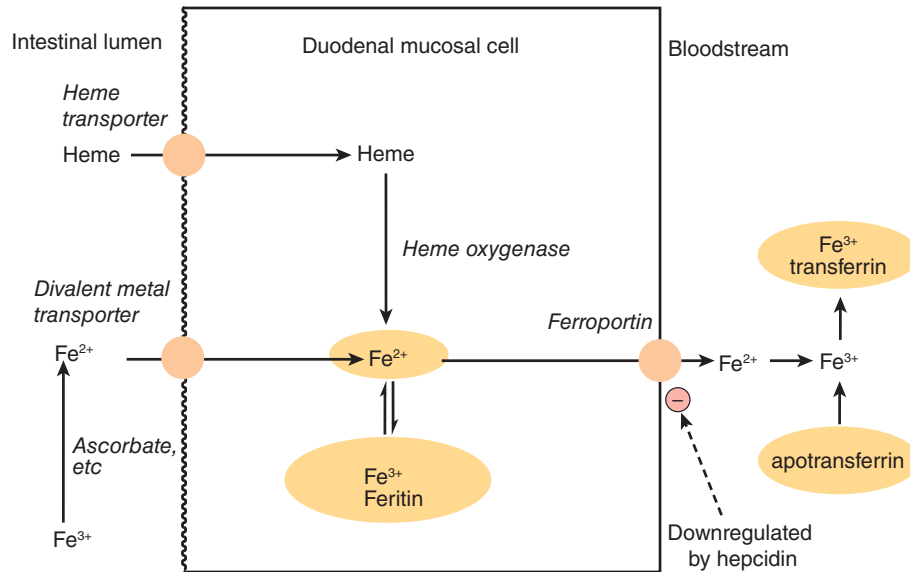

FIGURE 43-3 Absorption of iron. Hepcidin secreted by the liver downregulates synthesis of ferroportin and limits iron absorption.

A more recent technique permits estimation of total energy expenditure over a period of 1 to 2 weeks, using dual isotopically labeled water, $^2\text{H}_2^{18}\text{O}$. ^2H is lost from the body only in water, while ^{18}O is lost in both water and carbon dioxide; the difference in the rate of loss of the two labels permits estimation of total carbon dioxide production, and hence oxygen consumption and energy expenditure (Figure 43-4).

Basal metabolic rate (BMR) is the energy expenditure by the body when at rest, but not asleep, under controlled conditions of thermal neutrality, measured about 12 hours after the last meal, and depends on weight, age, and gender. **Total energy expenditure** depends on the BMR, the energy required for physical activity, and the energy cost of synthesizing reserves in the fed state. It is therefore possible to estimate an individual's energy requirement from body weight, age, gender, and level of physical activity. Body weight affects

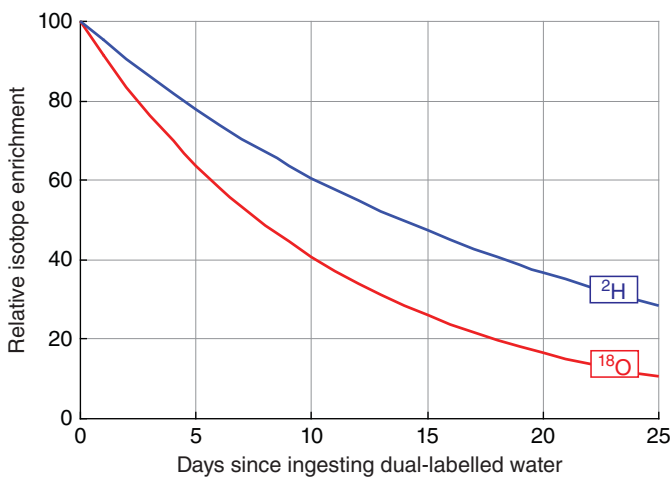

FIGURE 43-4 Dual isotopically labeled water for estimation of energy expenditure.

BMR because there is a greater amount of active tissue in a larger body. The decrease in BMR with increasing age, even when body weight remains constant, is the result of muscle tissue replacement by adipose tissue, which is metabolically less active. Similarly, women have a significantly lower BMR than do men of the same body weight and age because women's bodies contain proportionally more adipose tissue.

Energy Requirements Increase With Activity

The most useful way of expressing the energy cost of physical activities is as a multiple of BMR. This is known as the **physical activity ratio (PAR)** or **metabolic equivalent of the task (MET)**. Sedentary activities use only about 1.1 to 1.2 \times BMR. By contrast, vigorous exertion, such as climbing stairs, cross-country walking uphill, etc, may use 6 to 8 \times BMR. The overall **physical activity level (PAL)** is the sum of the PAR of different activities, multiplied by the time taken for that activity, divided by 24 hours.

Ten Percent of the Energy Yield of a Meal May Be Expended in Forming Reserves

There is a considerable increase in metabolic rate after a meal (**diet-induced thermogenesis**). A small part of this is the energy cost of secreting digestive enzymes and of active transport of the products of digestion; the major part is the result of synthesizing reserves of glycogen, triacylglycerol, and protein.

There Are Two Extreme Forms of Undernutrition

Marasmus can occur in both adults and children and occurs in vulnerable groups of all populations. **Kwashiorkor** affects

only children and has been reported only in developing countries. The distinguishing feature of kwashiorkor is that there is fluid retention, leading to edema, and fatty infiltration of the liver. Marasmus is a state of extreme emaciation; it is the outcome of prolonged negative energy balance. Not only have the body's fat reserves been exhausted, but there is wastage of muscle as well, and as the condition progresses there is loss of protein from the heart, liver, and kidneys. The amino acids released by the catabolism of tissue proteins are used as a source of metabolic fuel and as substrates for gluconeogenesis to maintain a supply of glucose for the brain and red blood cells (see Chapter 20). As a result of the reduced synthesis of proteins, there is impaired immune response and more risk from infections. Impairment of cell proliferation in the intestinal mucosa occurs, resulting in reduction in the surface area of the intestinal mucosa, and reduction in the absorption of such nutrients as are available.

Patients With Advanced Cancer and AIDS Are Malnourished

Patients with advanced cancer, HIV infection and AIDS, and a number of other chronic diseases are frequently undernourished, a condition called **cachexia**. Physically, they show all the signs of marasmus, but there is considerably more loss of body protein than that occurs in starvation. The secretion of cytokines in response to infection and cancer increases the catabolism of tissue protein by the ATP-dependent ubiquitin-proteasome pathway, so increasing energy expenditure. This differs from marasmus, in which protein synthesis is reduced, but catabolism is unaffected. Patients are **hypermetabolic**, ie, they have a considerably increased BMR. In addition to activation of the ubiquitin-proteasome pathway of protein catabolism, three other factors are involved. Many tumors metabolize glucose anaerobically to release lactate. This is then used for gluconeogenesis in the liver, which is energy consuming with a net cost of six ATP for each mol of glucose cycled (see Figure 19-4). There is increased stimulation of mitochondrial **uncoupling proteins** by **cytokines** leading to thermogenesis and increased oxidation of metabolic fuels. **Futile cycling of lipids** occurs because hormone sensitive lipase is activated by a proteoglycan secreted by tumors, resulting in liberation of fatty acids from adipose tissue and ATP-expensive reesterification to triacylglycerols in the liver, which are exported in VLDL.

Kwashiorkor Affects Undernourished Children

In addition to the wasting of muscle tissue, loss of intestinal mucosa and impaired immune responses seen in marasmus, children with **kwashiorkor** show a number of characteristic features. The defining feature is **edema**, associated with a decreased concentration of plasma proteins. In addition, there is enlargement of the liver as a result of accumulation of fat. It was formerly believed that the cause of kwashiorkor was a lack of protein, with a more or less adequate energy intake; however, analysis of the diets of affected children

shows that this is not so. Protein deficiency leads to stunting of growth, and children with kwashiorkor are less stunted than those with marasmus. Furthermore, the edema begins to improve early in treatment, when the child is still receiving a low protein diet.

Very commonly, an infection precipitates kwashiorkor. Superimposed on general food deficiency, there is probably a deficiency of antioxidant nutrients such as zinc, copper, carotene, and vitamins C and E. The **respiratory burst** in response to infection leads to the production of oxygen and halogen **free radicals** as part of the cytotoxic action of stimulated macrophages. This added oxidant stress triggers the development of kwashiorkor.

PROTEIN & AMINO ACID REQUIREMENTS

Protein Requirements Can Be Determined by Measuring Nitrogen Balance

The state of protein nutrition can be determined by measuring the dietary intake and output of nitrogenous compounds from the body. Although nucleic acids also contain nitrogen, protein is the major dietary source of nitrogen and measurement of total nitrogen intake gives a good estimate of protein intake ($\text{mg N} \times 6.25 = \text{mg protein}$, as N is 16% of most proteins). The output of N from the body is mainly in urea and smaller quantities of other compounds in urine, undigested protein in feces; significant amounts may also be lost in sweat and shed skin. The difference between intake and output of nitrogenous compounds is known as **nitrogen balance**. Three states can be defined. In a healthy adult, nitrogen balance is in **equilibrium**, when intake equals output, and there is no change in the total body content of protein. In a growing child, a pregnant woman, or a person in recovery from protein loss, the excretion of nitrogenous compounds is less than the dietary intake and there is net retention of nitrogen in the body as protein—**positive nitrogen balance**. In response to trauma or infection, or if the intake of protein is inadequate to meet requirements, there is net loss of protein nitrogen from the body—**negative nitrogen balance**. Except when replacing protein losses, nitrogen equilibrium can be maintained at any level of protein intake above requirements. A high intake of protein does not lead to positive nitrogen balance; although it increases the rate of protein synthesis, it also increases the rate of protein catabolism, so that nitrogen equilibrium is maintained, albeit with a higher rate of protein turnover. Both protein synthesis and catabolism are ATP expensive, and this increased rate of protein turnover explains the increased diet-induced thermogenesis seen in people consuming a high protein diet.

The continual catabolism of tissue proteins creates the requirement for dietary protein, even in an adult who is not growing; although some of the amino acids released can be reutilized, much is used for gluconeogenesis in the fasting state. Nitrogen balance studies show that the average daily requirement

is 0.66 g of protein per kg body weight (giving a reference intake of 0.825 g of protein/kg body weight, allowing for individual variation); ~55 g/d, or 0.825% of energy intake. Average intakes of protein in developed countries are of the order of 80 to 100 g/d, ie, 14% to 15% of energy intake. Because growing children are increasing the protein in the body, they have a proportionally greater requirement than adults and should be in positive nitrogen balance. Even so, the need is relatively small compared with the requirement for protein turnover. In some countries, protein intake is inadequate to meet these requirements, resulting in stunting of growth. There is little or no evidence that athletes and body builders require large amounts of protein; simply consuming more of a normal diet providing about 14% of energy from protein will provide more than enough protein for increased muscle protein synthesis—the main requirement is for an increased energy intake to permit increased protein synthesis.

There Is a Loss of Body Protein in Response to Trauma & Infection

One of the metabolic reactions to a major trauma, such as a burn, a broken limb, or surgery, is an increase in the net catabolism of tissue proteins, both in response to cytokines and glucocorticoid hormones, and as a result of excessive utilization of threonine and cysteine in the synthesis of **acute-phase proteins**. As much as 6% to 7% of the total body protein may be lost over 10 days. Prolonged bed rest results in considerable loss of protein because of atrophy of muscles. Protein catabolism may be increased in response to cytokines, and without the stimulus of exercise it is not completely replaced. Lost protein is replaced during **convalescence**, when there is positive nitrogen balance. Again, as in the case of athletes, a normal diet is adequate to permit this replacement protein synthesis.

The Requirement Is Not Just for Protein, but for Specific Amino Acids

Not all proteins are nutritionally equivalent. More of some is needed to maintain nitrogen balance than others because different proteins contain different amounts of the various amino acids. The body's requirement is for amino acids in the correct proportions to replace tissue proteins. The amino acids can be divided into two groups: **essential** and **nonessential**. There are nine essential or indispensable amino acids, which cannot be synthesized in the body: histidine, isoleucine, leucine, lysine, methionine, phenylalanine, threonine, tryptophan, and valine. If one of these is lacking or inadequate, then regardless of the total intake of protein, it will not be possible to maintain nitrogen balance since there will not be enough of that amino acid for protein synthesis.

Two amino acids, cysteine and tyrosine, can be synthesized in the body, but only from essential amino acid precursors—cysteine from methionine and tyrosine from phenylalanine. The dietary intakes of cysteine and tyrosine thus affect the requirements for methionine and phenylalanine. The remaining

11 amino acids in proteins are considered to be nonessential or dispensable since they can be synthesized as long as there is enough total protein in the diet. If one of these amino acids is omitted from the diet, nitrogen balance can still be maintained. However, only three amino acids, alanine, aspartate, and glutamate, can be considered to be truly dispensable; they are synthesized by transamination of common metabolic intermediates (pyruvate, oxaloacetate, and ketoglutarate, respectively). The remaining amino acids are considered as nonessential, but under some circumstances the requirement may outstrip the capacity for their synthesis.

SUMMARY

- Digestion involves hydrolyzing food molecules into smaller molecules for absorption through the gastrointestinal epithelium. Polysaccharides are absorbed as monosaccharides, triacylglycerols as 2-monoacylglycerols, fatty acids and glycerol, and proteins as amino acids and small peptides.
- Digestive disorders arise as a result of (1) enzyme deficiency, eg, lactase and sucrase; (2) malabsorption, eg, of glucose and galactose as a result of defects in the Na⁺-glucose cotransporter (SGLT 1); (3) absorption of unhydrolyzed polypeptides leading to immune responses, eg, as in celiac disease; and (4) precipitation of cholesterol from bile as gallstones.
- In addition to water, the diet must provide metabolic fuels (carbohydrate and fat) for body growth and activity, protein for synthesis of tissue proteins, fiber for bulk in the intestinal contents, minerals for specific metabolic functions (Chapter 44), polyunsaturated fatty acids of the *n*-3 and *n*-6 families, and vitamins-organic compounds needed in small amounts for other essential functions (see Chapter 44).
- Undernutrition occurs in two extreme forms: marasmus, in adults and children, and kwashiorkor in children. Chronic illness can also lead to undernutrition (cachexia) as a result of hypermetabolism.
- Overnutrition leads to excess energy intake and is associated with chronic noncommunicable diseases such as obesity, type 2 diabetes, atherosclerosis, cancer, and hypertension.
- Twenty different amino acids are required for protein synthesis, of which nine are essential in the human diet. The quantity of protein required can be determined by studies of nitrogen balance and is affected by protein quality—the amounts of essential amino acids present in dietary proteins compared with the amounts required for tissue protein synthesis.

REFERENCES

- Bender DA: *Introduction to Nutrition and Metabolism*, 5th ed. CRC Press, 2014.
- Bender DA, Bender AE: *Nutrition: A Reference Handbook*. Oxford University Press, 1997.
- Fuller MF, Garlick PJ: Human amino acid requirements: can the controversy be resolved? *Ann Rev Nutr* 1994;14:217.
- Geissler C, Powers HJ (editors): *Human Nutrition*, 12th ed. Elsevier, 2010.
- Gibney MJ, Lanham-New S, Cassidy A, et al: *Introduction to Human Nutrition, The Nutrition Society Textbook Series*, 2nd ed. Wiley-Blackwell, 2009.

Institute of Medicine: *Dietary Reference Intakes for Energy, Carbohydrate, Fiber, Fat, Fatty Acids, Cholesterol, Protein, and Amino Acids (Macronutrients)*. National Academies Press, 2002.

Pencharz PB, Ball RO: Different approaches to define individual amino acid requirements. *Ann Rev Nutr* 2003;23:101.

Royal College of Physicians: *Nutrition and Patients—A Doctor's Responsibility*. Royal College of Physicians, 2002.

Swallow DM: Genetic influences on carbohydrate digestion. *Nutr Res Rev* 2003;16:37.

World Health Organization Technical Report Series 894: *Obesity—Preventing and Managing the Global Epidemic*. WHO, 2000.

World Health Organization Technical Report Series 916: *Diet and the Prevention of Chronic Diseases*. WHO, 2003.

World Health Organization Technical report Series 935: *Protein and Amino Acid Requirements in Human Nutrition*. WHO, 2007.

Micronutrients: Vitamins & Minerals

David A. Bender, PhD

OBJECTIVES

*After studying this chapter,
you should be able to:*

- Describe how reference intakes for vitamins and minerals are determined and explain why reference intakes published by different national and international authorities differ.
- Define a vitamin and describe the metabolism, principal functions, deficiency diseases associated with inadequate intake, and the toxicity of excessive intakes of the vitamins.
- Explain why mineral salts are required in the diet.

BIOMEDICAL IMPORTANCE

Vitamins are a group of organic nutrients, required in small quantities for a variety of biochemical functions that, generally, cannot be synthesized by the body and must therefore be supplied in the diet.

The lipid-soluble vitamins are hydrophobic compounds that can be absorbed efficiently only when there is normal fat absorption. Like other lipids, they are transported in the blood in lipoproteins or attached to specific binding proteins. They have diverse functions—for example, vitamin A, vision and cell differentiation; vitamin D, calcium and phosphate metabolism, and cell differentiation; vitamin E, antioxidant; and vitamin K, blood clotting. As well as dietary inadequacy, conditions affecting the digestion and absorption of the lipid-soluble vitamins, such as a very low fat diet, steatorrhea and disorders of the biliary system, can all lead to deficiency syndromes, including night blindness and xerophthalmia (vitamin A); rickets in young children and osteomalacia in adults (vitamin D); neurological disorders and hemolytic anemia of the newborn (vitamin E); and hemorrhagic disease of the newborn (vitamin K). Toxicity can result from excessive intake of vitamins A and D. Vitamin A and the carotenes (many of which are precursors of vitamin A), and vitamin E are antioxidants (see Chapter 45) and have possible roles in prevention of atherosclerosis and cancer, although in excess they may also act as damaging pro-oxidants.

The water-soluble vitamins are vitamins B and C, folic acid, biotin and pantothenic acid; they function mainly as enzyme cofactors. Folic acid acts as a carrier of one-carbon units. Deficiency of a single vitamin of the B complex is rare

since poor diets are most often associated with **multiple deficiency states**. Nevertheless, specific syndromes are characteristic of deficiencies of individual vitamins, eg, beriberi (thiamin); cheilosis, glossitis, seborrhea (riboflavin); pellagra (niacin); megaloblastic anemia, methylmalonic aciduria, and pernicious anemia (vitamin B₁₂); megaloblastic anemia (folic acid); and scurvy (vitamin C).

Inorganic mineral elements that have a function in the body must be provided in the diet. When the intake is insufficient, deficiency signs may arise, eg, anemia (iron), and cretinism and goiter (iodine). Excessive intakes may be toxic.

The Determination of Micronutrient Requirements Depends on the Criteria of Adequacy Chosen

For any nutrient, there is a range of intakes between that which is clearly inadequate, leading to **clinical deficiency disease**, and that which is so much in excess of the body's metabolic capacity that there may be signs of **toxicity**. Between these two extremes is a level of intake that is adequate for normal health and the maintenance of metabolic integrity. Requirements are determined in depletion/repletion studies, in which people are deprived of the nutrient until there is a metabolic change, then repleted with the nutrient until the abnormality is normalized. Individuals do not all have the same requirement for nutrients, even when calculated on the basis of body size or energy expenditure. There is a range of individual requirements of up to 25% around the mean. Therefore, in order to assess the adequacy of diets, it is necessary to set a reference level of intake high enough to ensure that no-one either suffers from

deficiency or is at risk of toxicity. If it is assumed that individual requirements are distributed in a statistically normal fashion around the observed mean requirement, then a range of $\pm 2 \times$ the standard deviation (SD) around the mean includes the requirements of 95% of the population. Reference or recommended intakes are therefore set at the average requirement plus $2 \times$ SD, and so meet or exceed the requirements of 97.5% of the population.

Reference and recommended intakes of vitamins and minerals published by different national and international authorities (Tables 44–1 to 44–4) differ because of different interpretations of the available data, and the availability of new experimental data in more recent publications.

THE VITAMINS ARE A DISPARATE GROUP OF COMPOUNDS WITH A VARIETY OF METABOLIC FUNCTIONS

A vitamin is defined as an organic compound that is required in the diet in small amounts for the maintenance of normal metabolic integrity. Deficiency causes a specific disease, which is cured or prevented only by restoring the vitamin to the diet (Table 44–5). However, **vitamin D**, which is formed in the skin from 7-dehydrocholesterol on exposure to sunlight, and **niacin**, which can be formed from the essential amino acid tryptophan, do not strictly comply with this definition.

LIPID-SOLUBLE VITAMINS

TWO GROUPS OF COMPOUNDS HAVE VITAMIN A ACTIVITY

Retinoids comprise **retinol**, **retinaldehyde**, and **retinoic acid** (preformed vitamin A, found only in foods of animal origin); carotenoids, found in plants, are composed of carotenes and related compounds; many are precursors of vitamin A, as they can be cleaved to yield retinaldehyde, then retinol and retinoic acid (Figure 44–1). The α -, β -, and γ -carotenes and cryptoxanthin are quantitatively the most important provitamin A carotenoids. β -Carotene and other provitamin A carotenoids are cleaved in the intestinal mucosa by carotene dioxygenase, yielding retinaldehyde, which is reduced to retinol, esterified and secreted in chylomicrons together with esters formed from dietary retinol. The intestinal activity of carotene dioxygenase is low, so that a relatively large proportion of ingested β -carotene may appear in the circulation unchanged. There are two isoenzymes of carotene dioxygenase. One catalyzes cleavage of the central bond of β -carotene; the other catalyzes asymmetric cleavage leading to the formation of 8'-, 10'-, and 12'-apo-carotenals, which are oxidized to retinoic acid, but cannot be used as sources of retinol or retinaldehyde.

Although it would appear that one molecule of β -carotene should yield two of retinol, this is not so in practice; 6 μg of β -carotene is equivalent to 1 μg of preformed retinol. The total amount of vitamin A in foods is therefore expressed as micrograms of retinol equivalents = μg preformed vitamin A + $1/6 \times \mu\text{g}$ β -carotene + $1/12 \times \mu\text{g}$ other provitamin A carotenoids. Before pure vitamin A was available for chemical analysis, the vitamin A content of foods was determined by biological assay and the results expressed as international units (IU). 1 IU = 0.3 μg retinol; 1 μg retinol = 3.33 IU. Although obsolete, IU is sometimes still used in food labeling. In 2001, The USA/Canadian Dietary Reference Values report introduced the term *retinol activity equivalent* to take account of the incomplete absorption and metabolism of carotenoids; 1 RAE = 1 μg all-*trans*-retinol, 12 μg β -carotene, 24 μg α -carotene or β -cryptoxanthin. On this basis, 1 IU of vitamin A activity is equal to 3.6 μg β -carotene or 7.2 μg of other provitamin A carotenoids.

Vitamin A Has a Function in Vision

In the retina, retinaldehyde functions as the prosthetic group of the light-sensitive opsin proteins, forming **rhodopsin** (in rods) and **iodopsin** (in cones). Any one cone cell contains only one type of opsin and is sensitive to only one color. In the pigment epithelium of the retina, all-*trans*-retinol is isomerized to 11-*cis*-retinol and oxidized to 11-*cis*-retinaldehyde. This reacts with a lysine residue in opsin, forming the holo-protein rhodopsin. As shown in Figure 44–2, the absorption of light by rhodopsin causes isomerization of the retinaldehyde from 11-*cis* to all-*trans*, and a conformational change in opsin. This results in the release of retinaldehyde from the protein, and the initiation of a nerve impulse. The formation of the initial excited form of rhodopsin, bathorhodopsin, occurs within picoseconds of illumination. There is then a series of conformational changes leading to the formation of metarhodopsin II, which initiates a guanine nucleotide amplification cascade and then a nerve impulse. The final step is hydrolysis to release all-*trans*-retinaldehyde and opsin. The key to initiation of the visual cycle is the availability of 11-*cis*-retinaldehyde, and hence vitamin A. In deficiency, both the time taken to adapt to darkness and the ability to see in poor light are impaired.

Retinoic Acid Has a Role in the Regulation of Gene Expression and Tissue Differentiation

A major role of vitamin A is in the control of cell differentiation and turnover. All-*trans*-retinoic acid and 9-*cis*-retinoic acid (Figure 44–1) regulate growth, development, and tissue differentiation; they have different actions in different tissues. Like the thyroid and steroid hormones and vitamin D, retinoic acid binds to nuclear receptors that bind to response elements of DNA and regulate the transcription of specific genes. There are two families of nuclear retinoid receptors: the retinoic acid receptors (RAR) bind all-*trans*-retinoic acid or 9-*cis*-retinoic acid, and the retinoid X receptors (RXR) bind 9-*cis*-retinoic

TABLE 44-1 Reference Nutrient Intakes of Vitamins and Minerals, UK 1991

Age	Vit B ₁ (mg)	Vit B ₂ (mg)	Niacin (mg)	Vit B ₆ (mg)	Vit B ₁₂ (µg)	Folate (µg)	Vit C (mg)	Vit A (µg)	Vit D (µg)	Ca (mg)	P (mg)	Mg (mg)	Fe (mg)	Zn (mg)	Cu (mg)	Se (µg)	I (µg)
0-3 mo	0.2	0.4	3	0.2	0.3	50	25	350	8.5	525	400	55	1.7	4.0	0.2	10	50
4-6 mo	0.2	0.4	3	0.2	0.3	50	25	350	8.5	525	400	60	4.3	4.0	0.3	13	60
7-9 mo	0.2	0.4	4	0.3	0.4	50	25	350	7	525	400	75	7.8	5.0	0.3	10	60
10-12 mo	0.3	0.4	5	0.4	0.4	50	25	350	7	525	400	80	7.8	5.0	0.3	10	60
1-3 y	0.5	0.6	8	0.7	0.5	70	30	400	7	350	270	85	6.9	5.0	0.4	15	70
4-6 y	0.7	0.8	11	0.9	0.8	100	30	500	—	450	350	120	6.1	6.5	0.6	20	100
7-10 y	0.7	1.0	12	1.0	1.0	150	30	500	—	550	450	200	8.7	7.0	0.7	30	110
Males									—								
11-14 y	0.9	1.2	15	1.2	1.2	200	35	600	—	1000	775	280	11.3	9.0	0.8	45	130
15-18 y	1.1	1.3	18	1.5	1.5	200	40	700	—	1000	775	300	11.3	9.5	1.0	70	140
19-50 y	1.0	1.3	17	1.4	1.5	200	40	700	—	700	550	300	8.7	9.5	1.2	75	140
50+ y	0.9	1.3	16	1.4	1.5	200	40	700	10	700	550	300	8.7	9.5	1.2	75	140
Females																	
11-14 y	0.7	1.1	12	1.0	1.2	200	35	600	—	800	625	280	14.8	9.0	0.8	45	130
15-18 y	0.8	1.1	14	1.2	1.5	200	40	600	—	800	625	300	14.8	7.0	1.0	60	140
19-50 y	0.8	1.1	13	1.2	1.5	200	40	600	—	700	550	270	14.8	7.0	1.2	60	140
50+ y	0.8	1.1	12	1.2	1.5	200	40	600	10	700	550	270	8.7	7.0	1.2	60	140
Pregnant	+0.1	+0.3	—	—	—	+100	+10	+100	10	—	—	—					
Lactating	+0.1	+0.5	+2	—	+0.5	+60	+30	+350	10	+550	+440	+50		+6.0	+0.3	+15	

Source: Department of Health. *Dietary Reference Values for Food Energy and Nutrients for the United Kingdom*. HMSO, London, 1991.

TABLE 44-2 Population Reference Intakes of Vitamins and Minerals, European Union, 1993

Age	Vit A (µg)	Vit B ₁ (mg)	Vit B ₂ (mg)	Niacin (mg)	Vit B ₆ (mg)	Folate (µg)	Vit B ₁₂ (µg)	Vit C (mg)	Ca (mg)	P (mg)	Fe (mg)	Zn (mg)	Cu (mg)	Se (µg)	I (µg)
6-12 mo	350	0.3	0.4	5	0.4	50	0.5	20	400	300	6	4	0.3	8	50
1-3 y	400	0.5	0.8	9	0.7	100	0.7	25	400	300	4	4	0.4	10	70
4-6 y	400	0.7	1.0	11	0.9	130	0.9	25	450	350	4	6	0.6	15	90
7-10 y	500	0.8	1.2	13	1.1	150	1.0	30	550	450	6	7	0.7	25	100
Males															
11-14 y	600	1.0	1.4	15	1.3	180	1.3	35	1000	775	10	9	0.8	35	120
15-17 y	700	1.2	1.6	18	1.5	200	1.4	40	1000	775	13	9	1.0	45	130
18+ y	700	1.1	1.6	18	1.5	200	1.4	45	700	550	9	9.5	1.1	55	130
Females															
11-14 y	600	0.9	1.2	14	1.1	180	1.3	35	800	625	18	9	0.8	35	120
15-17 y	600	0.9	1.3	14	1.1	200	1.4	40	800	625	17	7	1.0	45	130
18+ y	600	0.9	1.3	14	1.1	200	1.4	45	700	550	16 ¹	7	1.1	55	130
Pregnant	700	1.0	1.6	14	1.3	400	1.6	55	700	550	1	7	1.1	55	130
Lactating	950	1.1	1.7	16	1.4	350	1.9	70	1200	950	16	12	1.4	70	160

Source: Scientific Committee for Food *Nutrient and energy intakes for the European Community*, Commission of the European Communities, Luxembourg, 1993.

¹No figure given for iron in pregnancy

TABLE 44-3 Recommended Dietary Allowances and Acceptable Intakes for Vitamins and Minerals, USA and Canada, 1997-2001

Age	Vit A (µg)	Vit D (µg)	Vit E (mg)	Vit K (µg)	Vit B ₁ (mg)	Vit B ₂ (mg)	Niacin (mg)	Vit B ₆ (mg)	Folate (µg)	Vit B ₁₂ (µg)	Vit C (mg)	Ca (mg)	P (mg)	Fe (mg)	Zn (mg)	Cu (mg)	Se (µg)	I (µg)	
0-6 mo	400	5	4	2.0	0.2	0.3	2	0.1	65	0.4	40	210	100	-	2.0	200	15	110	
7-12 mo	500	5	5	2.5	0.3	0.4	4	0.3	80	0.5	50	270	275	11	3	220	20	130	
1-3 y	300	5	6	30	0.5	0.5	6	0.5	150	0.9	15	500	460	7	3	340	20	90	
4-8 y	400	5	7	55	0.5	0.6	8	0.6	200	1.2	25	800	500	10	5	440	30	90	
Males																			
9-13 y	600	5	11	60	0.9	0.9	12	1.0	300	1.8	45	1300	1250	8	8	700	40	120	
14-18 y	900	5	15	75	1.2	1.3	16	1.3	400	2.4	75	1300	1250	11	11	890	55	150	
19-30 y	900	5	15	120	1.2	1.3	16	1.3	400	2.4	90	1000	700	8	11	900	55	150	
31-50 y	900	5	15	120	1.2	1.3	16	1.3	400	2.4	90	1000	700	8	11	900	55	150	
51-70 y	900	10	15	120	1.2	1.3	16	1.7	400	2.4	90	1200	700	8	11	900	55	150	
> 70 y	900	15	15	120	1.2	1.3	16	1.7	400	2.4	90	1200	700	8	11	900	55	150	
Females																			
9-13 y	600	5	11	60	0.9	0.9	12	1.0	300	1.8	45	1300	1250	8	8	700	40	120	
14-18 y	700	5	15	75	1.0	1.0	14	1.2	400	2.4	65	1300	1250	15	9	890	55	150	
19-30 y	700	5	15	90	1.1	1.1	14	1.3	400	2.4	75	1000	700	18	8	900	55	150	
31-50 y	700	5	15	90	1.1	1.1	14	1.3	400	2.4	75	1000	700	18	8	900	55	150	
51-70 y	700	10	15	90	1.1	1.1	14	1.5	400	2.4	75	1200	700	8	8	900	55	150	
> 70 y	700	15	15	90	1.1	1.1	14	1.5	400	2.4	75	1200	700	8	8	900	55	150	
Pregnant	770	5	15	90	1.4	1.4	18	1.9	600	2.6	85	1000	700	27	11	1000	60	220	
Lactating	900	5	16	90	1.4	1.6	17	2.0	500	2.8	120	1000	700	9	12	1300	70	290	

Figures for infants under 12 months are adequate intakes, based on the observed mean intake of infants fed principally on breast milk; for nutrients other than vitamin K figures are RDA, based on estimated average requirement + 2 SD; figures for vitamin K are adequate intakes, based on observed average intakes.

Source: Standing Committee on the Scientific Evaluation of Dietary Reference Intakes; Food and Nutrition Board, Institute of Medicine Dietary Reference Intakes for calcium, phosphorus, magnesium, vitamin D and fluoride, 1997; dietary reference intakes for thiamin, riboflavin, niacin, vitamin B₆, folate, vitamin B₁₂, pantothenic acid, biotin and choline, 1998; dietary reference intakes for vitamin C, vitamin E, selenium and carotenoids, 2000; dietary reference intakes for vitamin A, vitamin K, arsenic, boron, chromium, copper, iodine, iron, manganese, molybdenum, nickel, silicon, vanadium and zinc, 2001, National Academy Press, Washington DC.

TABLE 44-4 Recommended Nutrient Intakes for Vitamins, FAO 2001

Age	Vit A (μg)	Vit D (μg)	Vit K (μg)	Vit B ₁ (mg)	Vit B ₂ (mg)	Niacin (mg)	Vit B ₆ (mg)	Folate (μg)	Vit B ₁₂ (μg)	Vit C (mg)	Panto (mg)	Biotin (μg)
0-6 mo	375	5	5	0.2	0.3	2	0.1	80	0.4	25	1.7	5
7-12 mo	400	5	10	0.3	0.4	4	0.3	80	0.5	30	1.8	6
1-3 y	400	5	15	0.5	0.5	6	0.5	160	0.9	30	2.0	8
4-6 y	450	5	20	0.6	0.6	8	0.6	200	1.2	30	3.0	12
7-9 y	500	5	25	0.9	0.9	12	1.0	300	1.8	35	4.0	20
Males												
10-18 y	600	5	35-55	1.2	1.3	16	1.3	400	2.4	40	5.0	30
19-50 y	600	5	65	1.2	1.3	16	1.3	400	2.4	45	5.0	30
50-65 y	600	10	65	1.2	1.3	16	1.7	400	2.4	45	5.0	30
> 65 y	600	15	65	1.2	1.3	16	1.7	400	2.4	45	5.0	30
Female												
10-18 y	600	5	35-55	1.1	1.0	16	1.2	400	2.4	40	5.0	25
19-50 y	600	5	55	1.1	1.1	14	1.3	400	2.4	45	5.0	30
50-65 y	600	10	55	1.1	1.1	14	1.5	400	2.4	45	5.0	30
>65 y	600	15	55	1.1	1.1	14	1.5	400	2.4	45	5.0	30
Pregnant	800	5	55	1.4	1.4	18	1.9	600	2.6	55	6.0	30
Lactating	850	5	55	1.5	1.6	17	2.0	500	2.8	70	7.0	35

Source: Food and Agriculture Organization of the United Nations and World Health Organization, *Human Vitamin and Mineral Requirements*, FAO, 2001.

TABLE 44-5 The Vitamins

Vitamin	Functions	Deficiency Disease
Lipid-soluble		
A	Retinol, β -carotene	Visual pigments in the retina; regulation of gene expression and cell differentiation (β -carotene is an antioxidant)
D	Calciferol	Maintenance of calcium balance; enhances intestinal absorption of Ca^{2+} and mobilizes bone mineral; regulation of gene expression and cell differentiation
E	Tocopherols, tocotrienols	Antioxidant, especially in cell membranes; roles in cell signaling
K	Phylloquinone; menaquinones	Coenzyme in formation of γ -carboxyglutamate in enzymes of blood clotting and bone matrix
Water-soluble		
B ₁	Thiamin	Coenzyme in pyruvate and α -ketoglutarate dehydrogenases, and transketolase; regulates Cl^- channel in nerve conduction
B ₂	Riboflavin	Coenzyme in oxidation and reduction reactions (FAD and FMN); prosthetic group of flavoproteins
Niacin	Nicotinic acid, nicotinamide	Coenzyme in oxidation and reduction reactions, functional part of NAD and NADP; role in intracellular calcium regulation and cell signaling
B ₆	Pyridoxine, pyridoxal, pyridoxamine	Coenzyme in transamination and decarboxylation of amino acids and glycogen phosphorylase; modulation of steroid hormone action
	Folic acid	Coenzyme in transfer of one-carbon fragments
B ₁₂	Cobalamin	Coenzyme in transfer of one-carbon fragments and metabolism of folic acid
	Pantothenic acid	Functional part of CoA and acyl carrier protein: fatty acid synthesis and metabolism
H	Biotin	Coenzyme in carboxylation reactions in gluconeogenesis and fatty acid synthesis; role in regulation of cell cycle
C	Ascorbic acid	Coenzyme in hydroxylation of proline and lysine in collagen synthesis; antioxidant; enhances absorption of iron

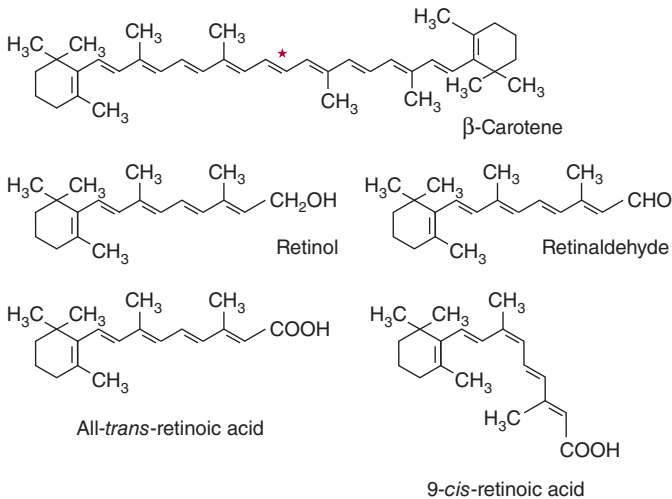

FIGURE 44-1 β-Carotene and the major vitamin A vitamers. Asterisk shows the site of symmetrical cleavage of β-carotene by carotene dioxygenase, to yield retinaldehyde.

acid. Retinoid X receptors also form dimers with vitamin D, thyroid, and other a nuclear acting hormone receptors. Deficiency of vitamin A impairs vitamin D and thyroid hormone function because of lack of 9-*cis*-retinoic acid to form active receptor dimers. Unoccupied retinoid X receptors form dimers with occupied vitamin D and thyroid hormone receptors, but not only do these not activate gene expression, they may repress it, so that vitamin A deficiency has a more severe effect on vitamin D and thyroid hormone function than simply failure to activate gene expression. Excessive vitamin A also impairs vitamin D and thyroid hormone function, because of formation of RXR homodimers, meaning that there are not enough RXR available to form heterodimers with the vitamin D and thyroid hormone receptors.

Vitamin A Deficiency Is a Major Public Health Problem Worldwide

Vitamin A deficiency is the most important preventable cause of blindness. The earliest sign of deficiency is a loss of sensitivity to green light, followed by impairment to adapt to dim light, then night blindness, an inability to see in the dark. More prolonged deficiency leads to **xerophthalmia**: keratinization of the cornea, and blindness. Vitamin A also has an important role in differentiation of immune system cells, and even mild deficiency leads to increased susceptibility to infectious diseases. The synthesis of retinol binding protein, which is required to transport the vitamin in the bloodstream, is reduced in response to infection (it is a negative **acute phase protein**), decreasing the circulating concentration of the vitamin, and further impairing immune responses.

Vitamin A Is Toxic in Excess

There is only a limited capacity to metabolize vitamin A, and excessive intakes lead to accumulation beyond the capacity of intracellular binding proteins; unbound vitamin A causes

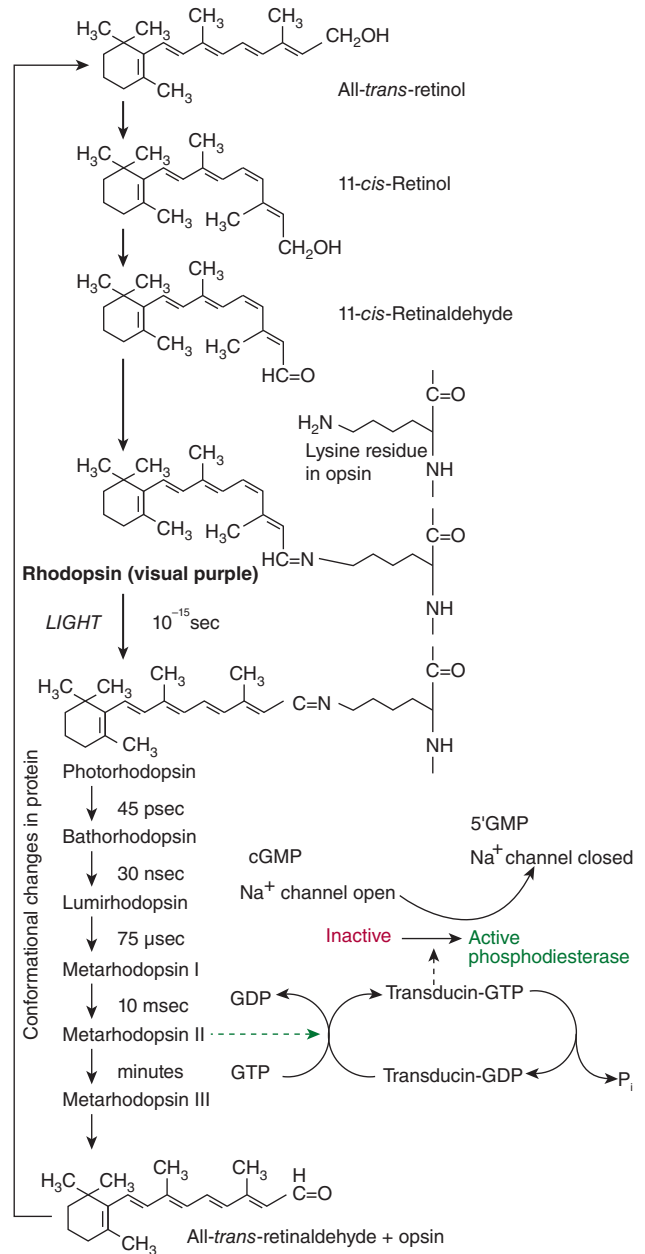

FIGURE 44-2 The role of retinaldehyde in the visual cycle.

membrane lysis and tissue damage. Symptoms of toxicity affect the central nervous system (headache, nausea, ataxia, and anorexia, all associated with increased cerebrospinal fluid pressure); the liver (hepatomegaly with histological changes and hyperlipidemia); calcium homeostasis (thickening of the long bones, hypercalcemia, and calcification of soft tissues); and the skin (excessive dryness, desquamation, and alopecia).

VITAMIN D IS REALLY A HORMONE

Vitamin D is not strictly a vitamin since it can be synthesized in the skin, and under most conditions this is the major source of the vitamin. Only when sunlight exposure is inadequate is a

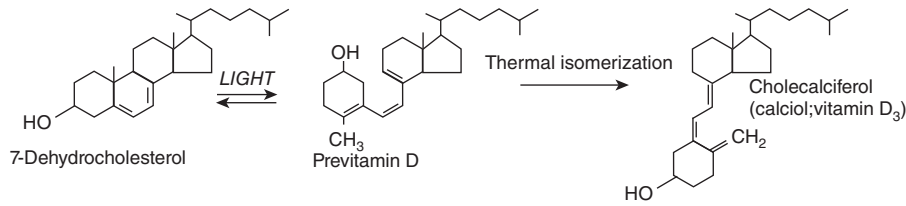

FIGURE 44-3 The synthesis of vitamin D in the skin.

dietary source required. Its main function is in the regulation of calcium absorption and homeostasis; most of its actions are mediated by way of nuclear receptors that regulate gene expression. It also has a role in regulating cell proliferation and differentiation. There is evidence that intakes considerably higher than are required to maintain calcium homeostasis reduce the risk of insulin resistance, obesity and the metabolic syndrome, as well as various cancers. Deficiency, leading to rickets in children and osteomalacia in adults, continues to be a problem in northern latitudes, where sunlight exposure is inadequate.

Vitamin D Is Synthesized in the Skin

7-Dehydrocholesterol (an intermediate in the synthesis of cholesterol that accumulates in the skin) undergoes a nonenzymic reaction on exposure to ultraviolet light, yielding previtamin D (Figure 44-3). This undergoes a further reaction over a period of hours to form cholecalciferol, which is absorbed into the bloodstream. In temperate climates, the plasma concentration of vitamin D is highest at the end of summer and lowest at the end of winter. Beyond latitudes about 40° north or south, there is very little ultraviolet radiation of the appropriate wavelength in winter.

Vitamin D Is Metabolized to the Active Metabolite, Calcitriol, in Liver & Kidney

Cholecalciferol, either synthesized in the skin or from food, undergoes two hydroxylations to yield the active metabolite, 1,25-dihydroxyvitamin D or calcitriol (Figure 44-4). Ergocalciferol from

fortified foods undergoes similar hydroxylation to yield ergocalciferol. In the liver, cholecalciferol is hydroxylated to form the 25-hydroxy-derivative, calcidiol. This is released into the circulation bound to a vitamin D binding globulin, which is the main storage form of the vitamin. In the kidney, calcidiol undergoes either 1-hydroxylation to yield the active metabolite 1,25-dihydroxyvitamin D (calcitriol), or 24-hydroxylation to yield a probably inactive metabolite, 24,25-dihydroxyvitamin D (24-hydroxycalcidiol). Some tissues, other than those that are involved in calcium homeostasis, take up calcidiol from the circulation and synthesize calcitriol that acts within the cell in which it was synthesized.

Vitamin D Metabolism Is Both Regulated by and Regulates Calcium Homeostasis

The main function of vitamin D is in the control of calcium homeostasis, and in turn, vitamin D metabolism is regulated by factors that respond to plasma concentrations of calcium and phosphate. Calcitriol acts to reduce its own synthesis by inducing the 24-hydroxylase and repressing the 1-hydroxylase in the kidney. The principal function of vitamin D is to maintain the plasma calcium concentration. Calcitriol achieves this in three ways: it increases intestinal absorption of calcium; it reduces excretion of calcium (by stimulating reabsorption in the distal renal tubules); and it mobilizes bone mineral. In addition, calcitriol is involved in insulin secretion, synthesis and secretion of parathyroid and thyroid hormones, inhibition of production of interleukin by activated T-lymphocytes

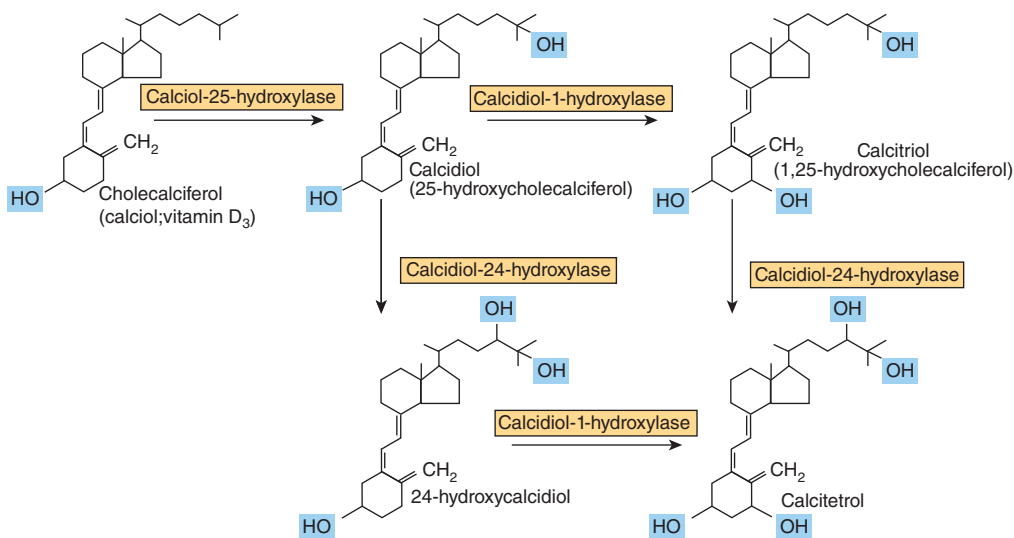

FIGURE 44-4 Metabolism of vitamin D.

and of immunoglobulin by activated B-lymphocytes, differentiation of monocyte precursor cells, and modulation of cell proliferation. In most of these actions, it acts like a steroid hormone, binding to nuclear receptors and enhancing gene expression, although it also has rapid effects on calcium transporters in the intestinal mucosa.

Higher Intakes of Vitamin D May Be Beneficial

There is growing evidence that higher vitamin D status is protective against various cancers, including prostate and colorectal cancer, and also against prediabetes and the metabolic syndrome. Desirable levels of intake may be considerably higher than current reference intakes, and certainly could not be met from unfortified foods. While increased sunlight exposure would meet the need, it carries the risk of developing skin cancer.

Vitamin D Deficiency Affects Children & Adults

In the vitamin D deficiency disease **rickets**, the bones of children are undermineralized as a result of poor absorption of calcium. Similar problems occur as a result of deficiency during the adolescent growth spurt. **Osteomalacia** in adults results from the demineralization of bone, especially in women who have little exposure to sunlight, especially after several pregnancies. Although vitamin D is essential for prevention and treatment of osteomalacia in the elderly, there is less evidence that it is beneficial in treating **osteoporosis**.

Vitamin D Is Toxic in Excess

Some infants are sensitive to intakes of vitamin D as low as 50 µg/d, resulting in an elevated plasma concentration of calcium. This can lead to contraction of blood vessels, high blood pressure, and **calcinosis**—the calcification of soft tissues. In at least a few cases, hypercalcemia in response to low intakes of vitamin D is due to genetic defects of calcidiol 24-hydroxylase, the enzyme that leads to inactivation of the vitamin. Although excess dietary vitamin D is toxic, excessive exposure to sunlight does not lead to vitamin D poisoning, because there is a limited capacity to form the precursor, 7-dehydrocholesterol, and prolonged exposure of previtamin D to sunlight leads to formation of inactive compounds.

VITAMIN E DOES NOT HAVE A PRECISELY DEFINED METABOLIC FUNCTION

No unequivocal unique function for vitamin E has been defined. It acts as a lipid-soluble **antioxidant** in cell membranes, where many of its functions can be provided by synthetic antioxidants, and is important in maintaining the fluidity of cell membranes. It also has a (relatively poorly defined) role in cell signaling. Vitamin E is the generic descriptor for two families of compounds, the **tocopherols** and the **tocotrienols**

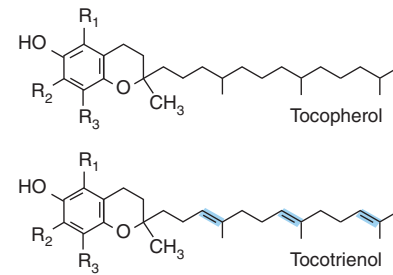

FIGURE 44-5 Vitamin E vitamers. In α -tocopherol and tocotrienol R_1 , R_2 , and R_3 are all $-\text{CH}_3$ groups. In the β -vitamers R_2 is H, in the γ -vitamers R_1 is H, and in the δ -vitamers R_1 and R_2 are both H.

(Figure 44-5). The different vitamers have different biological potency; the most active is D- α -tocopherol, and it is usual to express vitamin E intake in terms of milligrams D- α -tocopherol equivalents. Synthetic DL- α -tocopherol does not have the same biologic potency as the naturally occurring compound.

Vitamin E Is the Major Lipid-Soluble Antioxidant in Cell Membranes & Plasma Lipoproteins

The main function of vitamin E is as a chain-breaking, free-radical-trapping antioxidant in cell membranes and plasma lipoproteins by reacting with the lipid peroxide radicals formed by peroxidation of polyunsaturated fatty acids (see Chapter 45). The tocopheroxyl radical is relatively unreactive, and ultimately forms nonradical compounds. Commonly, the tocopheroxyl radical is reduced back to tocopherol by reaction with vitamin C from plasma (Figure 44-6). The resultant, stable, monodehydroascorbate radical then undergoes enzymic or nonenzymic reaction to yield ascorbate and dehydroascorbate, neither of which is a radical.

Vitamin E Deficiency

In experimental animals, vitamin E deficiency results in resorption of fetuses and testicular atrophy. Dietary deficiency of vitamin E in human beings is unknown, although patients with severe fat malabsorption, cystic fibrosis, and some forms of chronic liver disease suffer deficiency because they are unable to absorb the vitamin or transport it, exhibiting nerve and muscle membrane damage. Premature infants are born with inadequate reserves of the vitamin. The erythrocyte membranes are abnormally fragile as a result of lipid peroxidation, leading to hemolytic anemia.

VITAMIN K IS REQUIRED FOR SYNTHESIS OF BLOOD-CLOTTING PROTEINS

Vitamin K was discovered as a result of investigations into the cause of a bleeding disorder, hemorrhagic (sweet clover) disease of cattle and of chickens fed on a fat-free diet. The missing

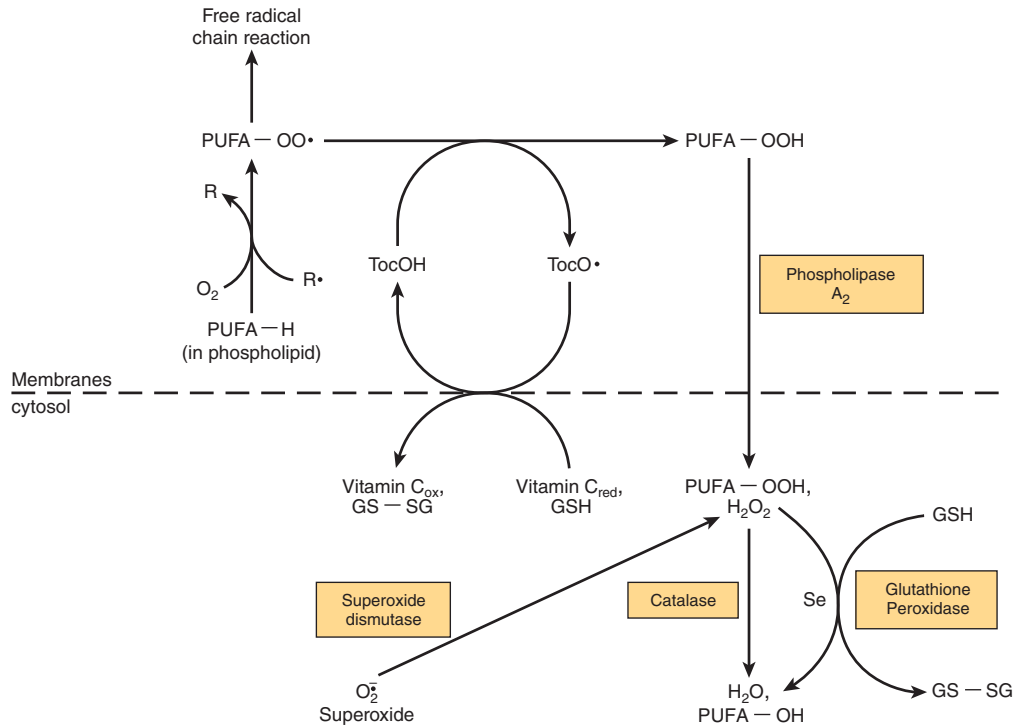

FIGURE 44-6 Interaction between antioxidants in the lipid phase (cell membranes) and the aqueous phase (cytosol). (R•, free radical; PUFA-OO•, peroxy radical of polyunsaturated fatty acid in membrane phospholipid; PUFA-OOH, hydroxyperoxy polyunsaturated fatty acid in membrane phospholipid, released into the cytosol as hydroxyperoxy polyunsaturated fatty acid by the action of phospholipase A₂; PUFA-OH, hydroxy polyunsaturated fatty acid; Toc-OH vitamin E [α -tocopherol]; TocO•, tocopheroxyl radical; Se, selenium; GSH, reduced glutathione; GS-SG, oxidized glutathione, which is reduced to GSH after reaction with NADPH, catalyzed by glutathione reductase; PUFA-H, polyunsaturated fatty acid.)

factor in the diet of the chickens was vitamin K, while the cattle feed contained **dicumarol**, an antagonist of the vitamin. Antagonists of vitamin K are used to reduce blood coagulation in patients at risk of thrombosis; the most widely used is **warfarin**.

Three compounds have the biological activity of vitamin K (**Figure 44-7**): **phyloquinone**, the normal dietary source, found in green vegetables; **menaquinones**, synthesized by intestinal bacteria, with differing lengths of side chain; and **menadione** and menadiol diacetate, synthetic compounds that can be metabolized to phyloquinone. Menaquinones are absorbed to some extent, but it is not clear to what extent they are biologically active as it is possible to induce signs of vitamin K deficiency simply by feeding a phyloquinone-deficient diet, without inhibiting intestinal bacterial action.

Vitamin K Is the Coenzyme for Carboxylation of Glutamate in Postsynthetic Modification of Calcium-Binding Proteins

Vitamin K is the cofactor for the carboxylation of glutamate residues in the postsynthetic modification of proteins to form the unusual amino acid γ -carboxyglutamate (Gla) (**Figure 44-8**). Initially, vitamin K hydroquinone is oxidized to the epoxide,

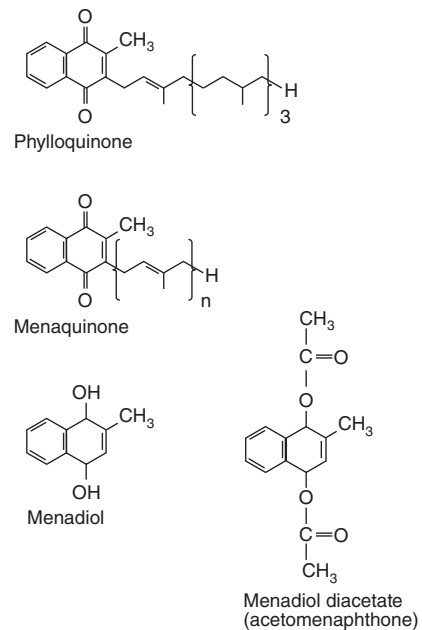

FIGURE 44-7 The vitamin K vitamers. Menadiol (or menadione) and menadiol diacetate are synthetic compounds that are converted to menaquinone in the liver.

Vitamin K Is Also Important in Synthesis of Bone & Other Calcium-Binding Proteins

A number of other proteins undergo the same vitamin K-dependent carboxylation of glutamate to γ -carboxyglutamate, including osteocalcin and the matrix Gla protein in bone, nephrocalcin in kidney and the product of the growth arrest specific gene Gas6, which is involved in both the regulation of differentiation and development in the nervous system, and control of apoptosis in other tissues. All of these γ -carboxyglutamate containing proteins bind calcium, which causes a conformational change so that they interact with membrane phospholipids. The release into the circulation of osteocalcin provides an index of vitamin D status.

WATER-SOLUBLE VITAMINS

VITAMIN B₁ (THIAMIN) HAS A KEY ROLE IN CARBOHYDRATE METABOLISM

Thiamin has a central role in energy-yielding metabolism, and especially the metabolism of carbohydrates (Figure 44–9). **Thiamin diphosphate** is the coenzyme for three multienzyme complexes that catalyze oxidative decarboxylation reactions: pyruvate dehydrogenase in carbohydrate metabolism (see Chapter 17); α -ketoglutarate dehydrogenase in the citric acid cycle (Chapter 16); and the branched-chain keto-acid dehydrogenase involved in the metabolism of leucine, isoleucine, and valine (see Chapter 29). In each case, the thiamin diphosphate provides a reactive carbon on the thiazole moiety that forms a carbanion, which then adds to the carbonyl group, eg, pyruvate. The addition compound is then decarboxylated, eliminating CO_2 . Thiamin diphosphate is also the coenzyme for transketolase, in the pentose phosphate pathway (see Chapter 20).

Thiamin triphosphate has a role in nerve conduction; it phosphorylates, and so activates, a chloride channel in the nerve membrane.

Thiamin Deficiency Affects the Nervous System & the Heart

Thiamin deficiency can result in three distinct syndromes: a chronic peripheral neuritis, **beriberi**, which may or may not be associated with **heart failure** and **edema**; acute pernicious (fulminating) beriberi (shoshin beriberi), in which heart failure

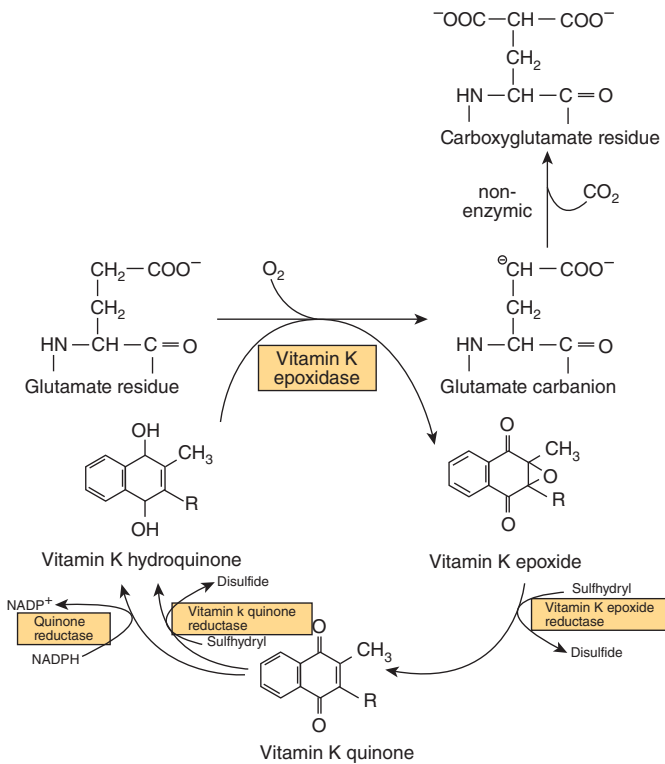

FIGURE 44–8 The role of vitamin K in the synthesis of γ -carboxyglutamate.

which activates a glutamate residue in the protein substrate to a carbanion, which reacts nonenzymatically with carbon dioxide to form γ -carboxyglutamate. Vitamin K epoxide is reduced to the quinone by a warfarin-sensitive reductase, and the quinone is reduced to the active hydroquinone by either the same warfarin-sensitive reductase or a warfarin-insensitive quinone reductase. In the presence of warfarin, vitamin K epoxide cannot be reduced, but accumulates and is excreted. If enough vitamin K (as the quinone) is provided in the diet, it can be reduced to the active hydroquinone by the warfarin-insensitive enzyme, and carboxylation can continue, with stoichiometric utilization of vitamin K and excretion of the epoxide. A high dose of vitamin K is the antidote to an overdose of warfarin.

Prothrombin and several other proteins of the blood-clotting system (Factors VII, IX, and X, and proteins C and S, Chapter 52) each contain 4 to 6 γ -carboxyglutamate residues. γ -Carboxyglutamate chelates calcium ions, and so permits the binding of the blood-clotting proteins to membranes. In vitamin K deficiency, or in the presence of warfarin, an abnormal precursor of prothrombin (preprothrombin) containing little or no γ -carboxyglutamate, and incapable of chelating calcium, is released into the circulation.

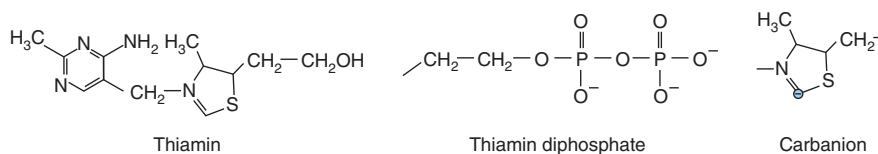

FIGURE 44–9 Thiamin, thiamin diphosphate, and the carbanion form.

and metabolic abnormalities predominate, without peripheral neuritis; and **Wernicke encephalopathy** with **Korsakoff psychosis**, which is associated especially with alcohol and narcotic abuse. The role of thiamin diphosphate in pyruvate dehydrogenase means that in deficiency there is impaired conversion of pyruvate to acetyl CoA. In subjects on a relatively high carbohydrate diet, this results in increased plasma concentrations of lactate and pyruvate, which may cause life-threatening **lactic acidosis**.

Thiamin Nutritional Status Can Be Assessed by Erythrocyte Transketolase Activation

The activation of apo-transketolase (the enzyme protein) in erythrocyte lysate by thiamin diphosphate added in vitro has become the accepted index of thiamin nutritional status.

VITAMIN B₂ (RIBOFLAVIN) HAS A CENTRAL ROLE IN ENERGY-YIELDING METABOLISM

Riboflavin provides the reactive moieties of the coenzymes **flavin mononucleotide (FMN)** and **flavin adenine dinucleotide (FAD)** (Figure 44–10). FMN is formed by ATP-dependent phosphorylation of riboflavin; FAD is synthesized by further reaction with ATP in which the AMP moiety is transferred onto FMN. The main dietary sources of riboflavin are milk and dairy products. In addition, because of its intense yellow color, riboflavin is widely used as a food additive.

Flavin Coenzymes Are Electron Carriers in Oxidoreduction Reactions

These include the mitochondrial respiratory chain, key enzymes in fatty acid and amino acid oxidation, and the citric acid cycle. Reoxidation of the reduced flavin in oxygenases and mixed-function oxidases proceeds by way of formation of the flavin radical and flavin hydroperoxide, with the intermediate generation

of superoxide and perhydroxyl radicals and hydrogen peroxide. Because of this, flavin oxidases make a significant contribution to the total oxidant stress in the body (see Chapter 45).

Riboflavin Deficiency Is Widespread But Not Fatal

Although riboflavin is centrally involved in lipid and carbohydrate metabolism, and deficiency occurs in many countries, it is not fatal, because there is very efficient conservation of tissue riboflavin. Riboflavin released by the catabolism of enzymes is rapidly incorporated into newly synthesized enzymes. Deficiency is characterized by cheilosis, desquamation and inflammation of the tongue, and a seborrheic dermatitis. Riboflavin nutritional status is assessed by measurement of the activation of erythrocyte glutathione reductase by FAD added in vitro.

NIACIN IS NOT STRICTLY A VITAMIN

Niacin was discovered as a nutrient during studies of **pellagra**. It is not strictly a vitamin since it can be synthesized in the body from the essential amino acid tryptophan. Two compounds, **nicotinic acid** and **nicotinamide**, have the biological activity of niacin; its metabolic function is as the nicotinamide ring of the coenzymes **NAD** and **NADP** in oxidation/reduction reactions (Figure 44–11). Some 60 mg of tryptophan is equivalent to 1 mg of dietary niacin. The niacin content of foods is expressed as

$$\text{mg niacin equivalents} = \text{mg preformed niacin} + 1/60 \times \text{mg tryptophan}$$

Since most of the niacin in cereals is biologically unavailable, this is discounted.

NAD Is the Source of ADP-Ribose

In addition to its coenzyme role, NAD is the source of ADP-ribose for the **ADP-ribosylation** of proteins and polyADP-ribosylation of nucleoproteins involved in the **DNA repair mechanism**. Cyclic ADP-ribose and nicotinic acid adenine dinucleotide, formed

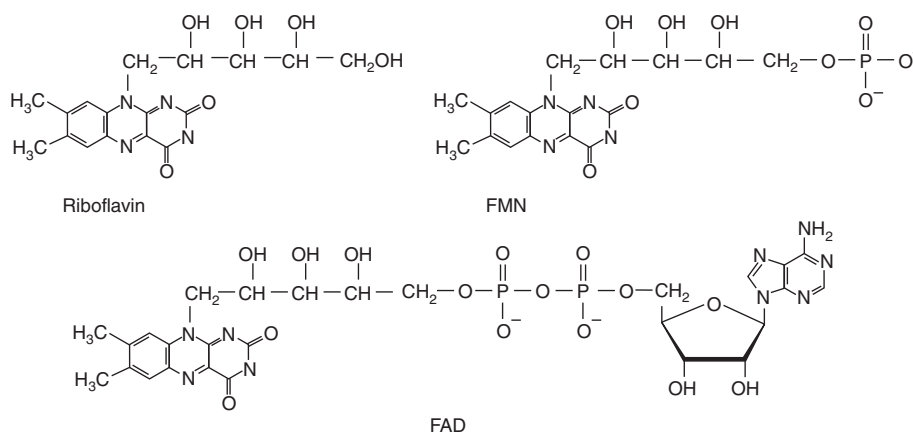

FIGURE 44–10 Riboflavin and the coenzymes flavin mononucleotide (FMN) and flavin adenine dinucleotide (FAD).

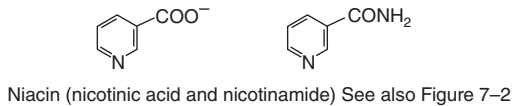

FIGURE 44–11 Niacin (nicotinic acid and nicotinamide).

from NAD, act to increase intracellular calcium in response to neurotransmitters and hormones.

Pellagra Is Caused by Deficiency of Tryptophan & Niacin

Pellagra is characterized by a photosensitive dermatitis. As the condition progresses, there is dementia and possibly diarrhea. Untreated pellagra is fatal. Although the nutritional etiology of pellagra is well established, and either tryptophan or niacin prevents or cures the disease, additional factors, including deficiency of riboflavin or vitamin B₆, both of which are required for synthesis of nicotinamide from tryptophan, may be important. In most outbreaks of pellagra, twice as many women as men are affected, probably the result of inhibition of tryptophan metabolism by estrogen metabolites.

Pellagra Can Occur as a Result of Disease Despite an Adequate Intake of Tryptophan & Niacin

A number of genetic diseases that result in defects of tryptophan metabolism are associated with the development of pellagra, despite an apparently adequate intake of both tryptophan and niacin. **Hartnup disease** is a rare genetic condition in which there is a defect of the membrane transport mechanism for tryptophan, resulting in large losses as a result of intestinal malabsorption and failure of renal reabsorption. In **carcinoid syndrome**, there is metastasis of a primary liver tumor of enterochromaffin cells, which synthesize 5-hydroxytryptamine. Overproduction of 5-hydroxytryptamine may account for as much as 60% of the body's tryptophan metabolism, causing pellagra because of the diversion away from NAD synthesis.

Niacin Is Toxic in Excess

Nicotinic acid has been used to treat hyperlipidemia when of the order of 1–6 g/d are required, causing dilatation of blood vessels and flushing, along with skin irritation. Intakes of both nicotinic acid and nicotinamide in excess of 500 mg/d also cause liver damage.

VITAMIN B₆ IS IMPORTANT IN AMINO ACID & GLYCOGEN METABOLISM & IN STEROID HORMONE ACTION

Six compounds have vitamin B₆ activity (**Figure 44–12**): **pyridoxine**, **pyridoxal**, **pyridoxamine**, and their 5'-phosphates. The active coenzyme is pyridoxal 5'-phosphate. Some 80% of

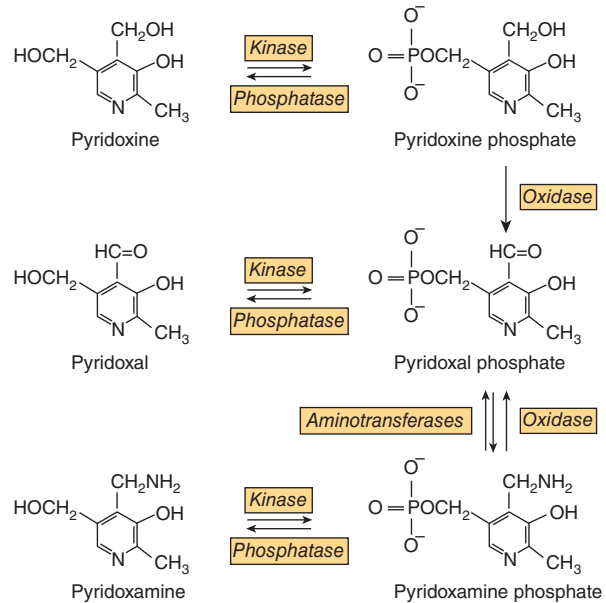

FIGURE 44–12 Interconversion of the vitamin B₆ vitamers.

the body's total vitamin B₆ is pyridoxal phosphate in muscle, mostly associated with glycogen phosphorylase. This is not available in deficiency, but is released in starvation, when glycogen reserves become depleted, and is then available, especially to liver and kidney, to meet increased requirement for gluconeogenesis from amino acids.

Vitamin B₆ Has Several Roles in Metabolism

Pyridoxal phosphate is a coenzyme for many enzymes involved in amino acid metabolism, especially transamination and decarboxylation. It is also the cofactor of glycogen phosphorylase, where the phosphate group is catalytically important. In addition, B₆ is important in steroid hormone action. Pyridoxal phosphate removes the hormone-receptor complex from DNA binding, terminating the action of the hormones. In vitamin B₆ deficiency, there is increased sensitivity to the actions of low concentrations of estrogens, androgens, cortisol, and vitamin D.

Vitamin B₆ Deficiency Is Rare

Although clinical deficiency disease is rare, there is evidence that a significant proportion of the population have marginal vitamin B₆ status. Moderate deficiency results in abnormalities of tryptophan and methionine metabolism. Increased sensitivity to steroid hormone action may be important in the development of **hormone-dependent cancer** of the breast, uterus, and prostate, and vitamin B₆ status may affect the prognosis.

Vitamin B₆ Status Is Assessed by Assaying Erythrocyte Transaminases

The most widely used method of assessing vitamin B₆ status is by the activation of erythrocyte transaminases by pyridoxal phosphate added in vitro, expressed as the activation coefficient.

Measurement of plasma concentrations of the vitamin are also used.

In Excess, Vitamin B₆ Causes Sensory Neuropathy

The development of sensory neuropathy has been reported in patients taking 2 to 7 g of pyridoxine per day for a variety of reasons (there is some slight evidence that it is effective in treating **premenstrual syndrome**). There was some residual damage after withdrawal of these high doses; other reports suggest that intakes in excess of 100 to 200 mg/d are associated with neurological damage.

VITAMIN B₁₂ IS FOUND ONLY IN FOODS OF ANIMAL ORIGIN

The term “vitamin B₁₂” is used as a generic descriptor for the **cobalamins**—those **corrinooids** (cobalt-containing compounds possessing the corrin ring) having the biologic activity of the vitamin (**Figure 44–13**). Some corrinooids that are growth factors for microorganisms not only have no vitamin B₁₂ activity, but may also be antimetabolites of the vitamin. Although it is synthesized exclusively by microorganisms, for practical purposes vitamin B₁₂ is found only in foods of animal origin, there being no plant sources of this vitamin. This means that strict vegetarians (vegans) are at risk of developing B₁₂ deficiency. The small amounts of the vitamin formed by bacteria on the surface of fruits may be adequate to meet requirements,

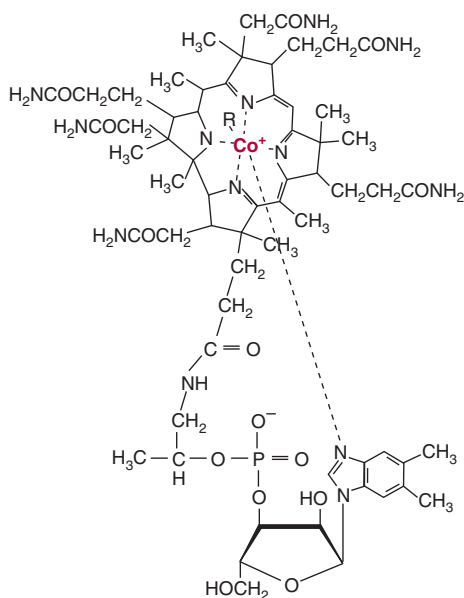

FIGURE 44–13 Vitamin B₁₂. Four coordination sites on the central cobalt atom are chelated by the nitrogen atoms of the corrin ring, and one by the nitrogen of the dimethylbenzimidazole nucleotide. The sixth coordination site may be occupied by: CN[−] (cyanocobalamin), OH[−] (hydroxocobalamin), H₂O (aquocobalamin), —CH₃ (methyl cobalamin), or 5′-deoxyadenosine (adenosylcobalamin).

but preparations of vitamin B₁₂ made by bacterial fermentation are available.

Vitamin B₁₂ Absorption Requires Two Binding Proteins

Vitamin B₁₂ is absorbed bound to **intrinsic factor**, a small glycoprotein secreted by the parietal cells of the gastric mucosa. Gastric acid and pepsin release the vitamin from protein binding in food and make it available to bind to **cobalophilin**, a binding protein secreted in the saliva. In the duodenum, cobalophilin is hydrolyzed, releasing the vitamin for binding to intrinsic factor. **Pancreatic insufficiency** can therefore be a factor in the development of vitamin B₁₂ deficiency, resulting in the excretion of cobalophilin-bound vitamin B₁₂. Intrinsic factor binds only the active vitamin B₁₂ vitamers and not other corrinooids. Vitamin B₁₂ is absorbed from the distal third of the ileum via receptors that bind the intrinsic factor-vitamin B₁₂ complex, but not free intrinsic factor or free vitamin. There is considerable enterohepatic circulation of vitamin B₁₂, with excretion in the bile, then reabsorption after binding to intrinsic factor in the ileum.

There Are Two Vitamin B₁₂-Dependent Enzymes

Methylmalonyl CoA mutase, and **methionine synthase** (**Figure 44–14**) are vitamin B₁₂-dependent enzymes. Methylmalonyl CoA is formed as an intermediate in the catabolism of valine and by the carboxylation of propionyl CoA arising in the catabolism of isoleucine, cholesterol, and rare fatty acids with an odd number of carbon atoms, or directly from propionate, a major product of microbial fermentation in the rumen. It undergoes a vitamin B₁₂-dependent rearrangement to succinyl CoA, catalyzed by methylmalonyl CoA mutase (see Figure 19–2). The activity of this enzyme is greatly reduced in vitamin B₁₂ deficiency, leading to an accumulation of methylmalonyl CoA and urinary excretion of methylmalonic acid, which provides a means of assessing vitamin B₁₂ nutritional status.

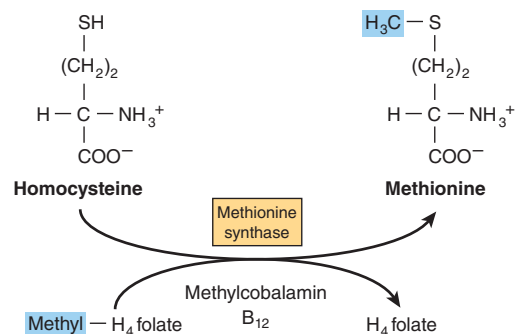

FIGURE 44–14 Homocysteine and the “folate trap.” Vitamin B₁₂ deficiency leads to impairment of methionine synthase, resulting in accumulation of homocysteine and trapping folate as methyltetrahydrofolate.

Vitamin B₁₂ Deficiency Causes Pernicious Anemia

Pernicious anemia arises when vitamin B₁₂ deficiency impairs the metabolism of folic acid, leading to functional folate deficiency that disturbs erythropoiesis, causing immature precursors of erythrocytes to be released into the circulation (megaloblastic anemia). The most common cause of pernicious anemia is failure of the absorption of vitamin B₁₂ rather than dietary deficiency. This can be the result of failure of intrinsic factor secretion caused by autoimmune disease affecting parietal cells or from production of anti-intrinsic factor antibodies. There is irreversible degeneration of the spinal cord in pernicious anemia, as a result of failure of methylation of one arginine residue in myelin basic protein. This is the result of methionine deficiency in the central nervous system, rather than secondary folate deficiency.

THERE ARE MULTIPLE FORMS OF FOLATE IN THE DIET

The active form of folic acid (pteroyl glutamate) is tetrahydrofolate (Figure 44–15). The folates in foods may have up to seven additional glutamate residues linked by γ -peptide bonds. In addition, all of the one-carbon substituted folates in Figure 44–15 may also be present in foods. The extent to which the different forms of folate can be absorbed varies, and folate intakes are calculated as dietary folate equivalents—the

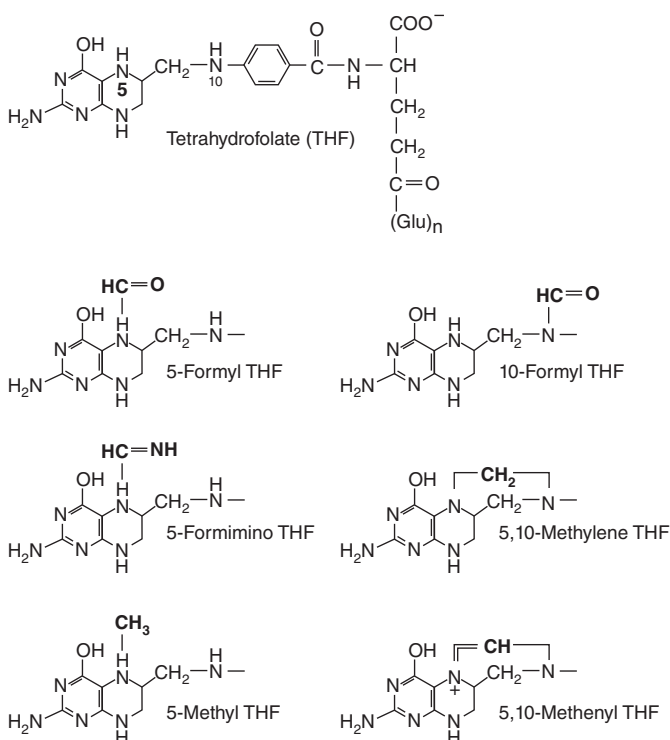

FIGURE 44–15 Tetrahydrofolic acid and the one-carbon substituted folates.

sum of μg food folates + $1.7 \times \mu\text{g}$ of folic acid (used in food enrichment).

Tetrahydrofolate Is a Carrier of One-Carbon Units

Tetrahydrofolate can carry one-carbon fragments attached to *N*-5 (formyl, formimino, or methyl groups), *N*-10 (formyl) or bridging *N*-5–*N*-10 (methylene or methenyl groups). 5-Formyl-tetrahydrofolate is more stable than folate and is therefore used pharmaceutically (known as **folinic acid**), and the synthetic (racemic) compound (**leucovorin**). The major point of entry for one-carbon fragments into substituted folates is methylene-tetrahydrofolate (Figure 44–16), which is formed by the reaction of glycine, serine, and choline with tetrahydrofolate. Serine is the most important source of substituted folates for biosynthetic reactions, and the activity of serine hydroxymethyltransferase is regulated by the state of folate substitution and the availability of folate. The reaction is reversible, and in liver it can form serine from glycine as a substrate for gluconeogenesis. Methylene-, methenyl-, and 10-formyl-tetrahydrofolates are interconvertible. When one-carbon folates are not required, the oxidation of formyl-tetrahydrofolate to yield carbon dioxide provides a means of maintaining a pool of free folate.

Inhibitors of Folate Metabolism Provide Cancer Chemotherapy, Antibacterial, & Antimalarial Drugs

The methylation of deoxyuridine monophosphate (dUMP) to thymidine monophosphate (TMP), catalyzed by thymidylate synthase, is essential for the synthesis of DNA. The one-carbon fragment of methylene-tetrahydrofolate is reduced to a methyl group with release of dihydrofolate, which is then reduced back to tetrahydrofolate by **dihydrofolate reductase**. Thymidylate synthase and dihydrofolate reductase are especially active in tissues with a high rate of cell division. **Methotrexate**, an analog of 10-methyl-tetrahydrofolate, inhibits dihydrofolate reductase and has been exploited as an anticancer drug. The dihydrofolate reductases of some bacteria and parasites differ from the human enzyme; inhibitors of these enzymes can be used as antibacterial drugs (eg, **trimethoprim**) and antimalarial drugs (eg, **pyrimethamine**).

Vitamin B₁₂ Deficiency Causes Functional Folate Deficiency—the “Folate Trap”

When acting as a methyl donor, *S*-adenosyl methionine forms homocysteine, which may be remethylated by methyl-tetrahydrofolate catalyzed by methionine synthase, a vitamin B₁₂-dependent enzyme (Figure 44–14). As the reduction of methylene-tetrahydrofolate to methyl-tetrahydrofolate is irreversible and the major source of tetrahydrofolate for tissues is methyl-tetrahydrofolate, the role of methionine synthase is vital, and

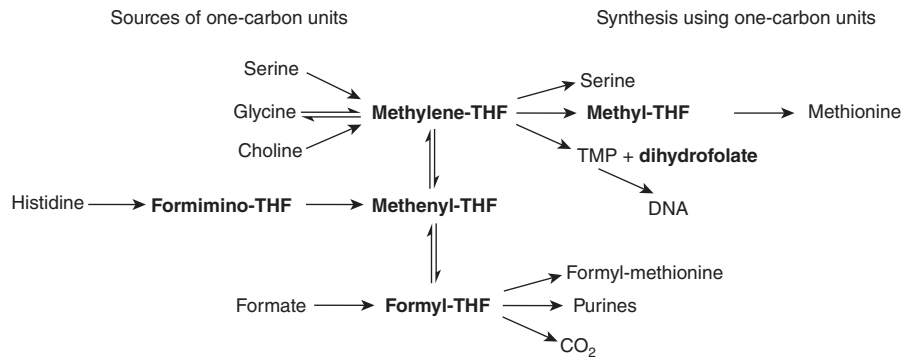

FIGURE 44-16 Sources and utilization of one-carbon substituted folates.

provides a link between the functions of folate and vitamin B₁₂. Impairment of methionine synthase in vitamin B₁₂ deficiency results in the accumulation of methyltetrahydrofolate that cannot be used — the “folate trap.” There is therefore functional deficiency of folate, secondary to the deficiency of vitamin B₁₂.

Folate Deficiency Causes Megaloblastic Anemia

Deficiency of folic acid itself or deficiency of vitamin B₁₂, which leads to functional folic acid deficiency, affects cells that are dividing rapidly because they have a large requirement for thymidine for DNA synthesis. Clinically, this affects the bone marrow, leading to megaloblastic anemia.

Folic Acid Supplements Reduce the Risk of Neural Tube Defects & Hyperhomocysteinemia, & May Reduce the Incidence of Cardiovascular Disease & Some Cancers

Supplements of 400 µg/d of folate begun before conception result in a significant reduction in the incidence of **spina bifida** and other **neural tube defects**. Because of this, there is mandatory enrichment of flour with folic acid in many countries. Elevated blood homocysteine is a significant risk factor for **atherosclerosis**, **thrombosis**, and **hypertension**. The condition is the result of an impaired ability to form methyltetrahydrofolate by methylene-tetrahydrofolate reductase, causing functional folate deficiency, resulting in failure to remethylate homocysteine to methionine. People with an abnormal variant of methylene-tetrahydrofolate reductase that occurs in 5% to 10% of the population do not develop hyperhomocysteinemia if they have a relatively high intake of folate. A number of placebo-controlled trials of supplements of folate (commonly together with vitamins B₆ and B₁₂) have shown the expected lowering of plasma homocysteine, but apart from reduced incidence of stroke there has been no effect on death from cardiovascular disease.

There is also evidence that low folate status results in impaired methylation of CpG islands in DNA, which is a factor

in the development of colorectal and other cancers. A number of studies suggest that folic acid supplementation or food enrichment may reduce the risk of developing some cancers. However, there is also some evidence that folate supplements increase the rate of transformation of preneoplastic colorectal polyps into cancers, so that people with such polyps may be at increased risk of developing colorectal cancer if they have a high folate intake.

Folic Acid Enrichment of Foods May Put Some People at Risk

Folic acid supplements will rectify the megaloblastic anemia of vitamin B₁₂ deficiency but not the irreversible nerve damage seen in vitamin B₁₂ deficiency. A high intake of folic acid can thus mask vitamin B₁₂ deficiency. This is especially a problem for elderly people, since atrophic gastritis that develops with increasing age leads to failure of gastric acid secretion, and hence failure to release vitamin B₁₂ from dietary proteins. Because of this, although many countries have adopted mandatory enrichment of flour with folic acid to prevent neural tube defects, others have not. There is also antagonism between folic acid and some anticonvulsants used in the treatment of epilepsy, and, as noted above, there is some evidence that folate supplements may increase the risk of developing colorectal cancer among people with preneoplastic colorectal polyps.

DIETARY BIOTIN DEFICIENCY IS UNKNOWN

The structures of biotin, biocytin, and carboxybiotin (the active metabolic intermediate) are shown in **Figure 44-17**. Biotin is widely distributed in many foods as biocytin (ε-amino-biotinyllysine), which is released on proteolysis. It is synthesized by intestinal flora in excess of requirements. Deficiency is unknown, except among people maintained for many months on total parenteral nutrition, and a very small number who eat abnormally large amounts of uncooked egg white, which contains avidin, a protein that binds biotin and renders it unavailable for absorption.

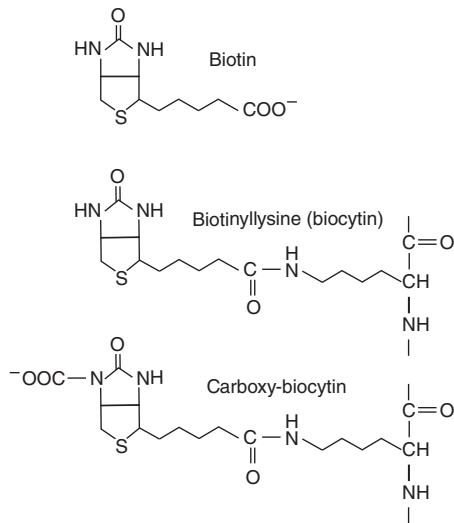

FIGURE 44-17 Biotin, biocytin, and carboxy-biocytin.

Biotin Is a Coenzyme of Carboxylase Enzymes

Biotin functions to transfer carbon dioxide in a small number of reactions: acetyl-CoA carboxylase (see Figure 23-1), pyruvate carboxylase (Figure 19-1), propionyl-CoA carboxylase (see Figure 19-2), and methylcrotonyl-CoA carboxylase. A holocarboxylase synthetase catalyzes the transfer of biotin onto a lysine residue of the apo-enzyme to form the biocytin residue of the holoenzyme. The reactive intermediate is 1-*N*-carboxybiocytin, formed from bicarbonate in an ATP-dependent reaction. The carboxyl group is then transferred to the substrate for carboxylation.

Biotin also has a role in regulation of the cell cycle, acting to biotinylate key nuclear proteins.

AS PART OF CoA & ACP, PANTOTHENIC ACID ACTS AS A CARRIER OF ACYL GROUPS

Pantothenic acid has a central role in acyl group metabolism when acting as the pantotheine functional moiety of coenzyme A or acyl carrier protein (ACP) (Figure 44-18). The pantotheine moiety is formed after combination of pantothenate with cysteine, which provides the—SH prosthetic group of CoA and ACP. CoA takes part in reactions of the citric acid cycle (see Chapter 16), fatty acid oxidation (see Chapter 22), acetylations, and cholesterol synthesis (Chapter 26). ACP participates in fatty acid synthesis (see Chapter 23). The vitamin is widely distributed in all food-stuffs, and deficiency has not been unequivocally reported in humans except in specific depletion studies.

ASCORBIC ACID IS A VITAMIN FOR ONLY SOME SPECIES

Vitamin C (Figure 44-19) is a vitamin for human beings and other primates, the guinea pig, bats, passeriform birds, and

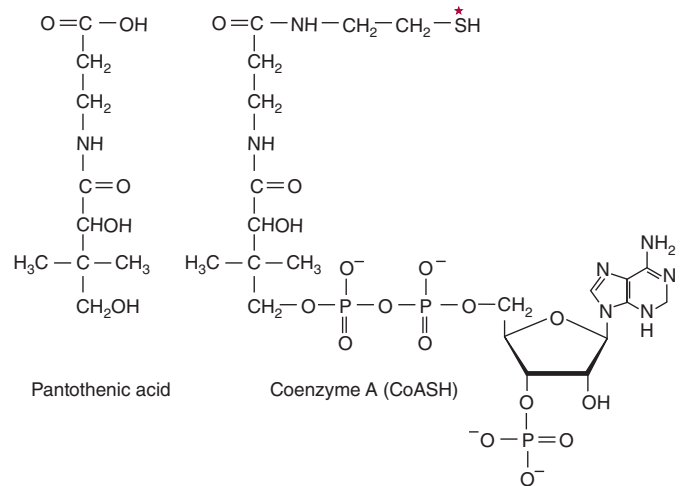

FIGURE 44-18 Pantothenic acid and coenzyme A. Asterisk shows site of acylation by fatty acids.

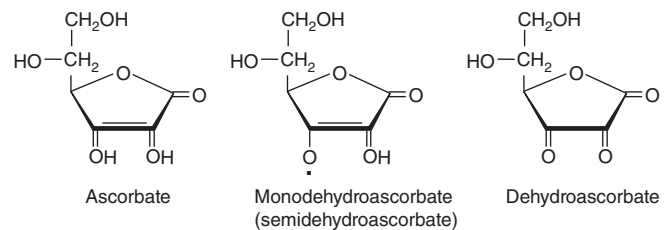

FIGURE 44-19 Vitamin C.

most fishes and invertebrates; other animals synthesize it as an intermediate in the uronic acid pathway of glucose metabolism (see Figure 20-4). In those species for which it is a vitamin, there is a block in the pathway as a result of the absence of gulonolactone oxidase. Both ascorbic acid and dehydroascorbic acid have vitamin activity.

Vitamin C Is the Coenzyme for Two Groups of Hydroxylases

Ascorbic acid has specific roles in the copper-containing hydroxylases and the α -ketoglutarate-linked iron-containing hydroxylases. It also increases the activity of a number of other enzymes *in vitro*, although this is a nonspecific reducing action. In addition, it has a number of nonenzymic effects as a result of its action as a reducing agent and oxygen radical quencher (see Chapter 45).

Dopamine β -hydroxylase is a copper-containing enzyme involved in the synthesis of the catecholamines (norepinephrine and epinephrine), from tyrosine in the adrenal medulla and central nervous system. During hydroxylation the Cu^+ is oxidized to Cu^{2+} ; reduction back to Cu^+ specifically requires ascorbate, which is oxidized to monodehydroascorbate.

A number of peptide hormones have a carboxy terminal amide that is derived from a terminal glycine residue. This glycine is hydroxylated on the α -carbon by a copper-containing

enzyme, **peptidylglycine hydroxylase**, which, again, requires ascorbate for reduction of Cu^{2+} .

A number of iron-containing, ascorbate-requiring hydroxylases share a common reaction mechanism, in which hydroxylation of the substrate is linked to oxidative decarboxylation of α -ketoglutarate. Many of these enzymes are involved in the modification of precursor proteins. **Proline** and **lysine hydroxylases** are required for the postsynthetic modification of **procollagen** to **collagen**, and proline hydroxylase is also required in formation of **osteocalcin** and the C1q component of **complement**. Aspartate β -hydroxylase is required for the postsynthetic modification of the precursor of protein C, the vitamin K-dependent protease that hydrolyzes activated factor V in the blood-clotting cascade (see Chapter 52). Trimethyllysine and γ -butyrobetaine hydroxylases are required for the synthesis of carnitine.

Vitamin C Deficiency Causes Scurvy

Signs of vitamin C deficiency include skin changes, fragility of blood capillaries, gum decay, tooth loss, and bone fracture, many of which can be attributed to deficient collagen synthesis.

There May Be Benefits from Higher Intakes of Vitamin C

At intakes above about 100 mg/d, the body's capacity to metabolize vitamin C is saturated, and any further intake is excreted in the urine. However, in addition to its other roles, vitamin C enhances the absorption of inorganic iron, and this depends on the presence of the vitamin in the gut. Therefore, increased intakes may be beneficial. There is very little good evidence that high doses of vitamin C prevent the common cold, although they may reduce the duration and severity of symptoms.

MINERALS ARE REQUIRED FOR BOTH PHYSIOLOGIC & BIOCHEMICAL FUNCTIONS

Many of the essential minerals (Table 44-6) are widely distributed in foods, and most people eating a mixed diet are likely to receive adequate intakes. The amounts required vary from grams per day for sodium and calcium, through milligrams per day (eg, iron and zinc), to micrograms per day for the trace elements. In general, mineral deficiencies occur when foods come from one region where the soil may be deficient in some minerals (eg, iodine and selenium, deficiencies of both of which occur in many areas of the world). When foods come from a variety of regions, mineral deficiency is less likely to occur. Iron deficiency is an important problem worldwide, because if iron losses from the body are relatively high (eg, from heavy menstrual blood loss or intestinal parasites), it is difficult to achieve an adequate intake to replace losses. However, 10% of the population (and more in some areas)

TABLE 44-6 Classification of Minerals According to Their Function

Function	Mineral
Structural function	Calcium, magnesium, phosphate
Involved in membrane function	Sodium, potassium
Function as prosthetic groups in enzymes	Cobalt, copper, iron, molybdenum, selenium, zinc
Regulatory role or role in hormone action	Calcium, chromium, iodine, magnesium, manganese, sodium, potassium
Known to be essential, but function unknown	Silicon, vanadium, nickel, tin
Have effects in the body, but essentiality is not established	Fluoride, lithium
May occur in foods and known to be toxic in excess	Aluminum, arsenic, antimony, boron, bromine, cadmium, cesium, germanium, lead, mercury, silver, strontium

are genetically at risk of iron overload, leading to formation of free radicals as a result of nonenzymic reactions of iron ions in free solution when the capacity of iron binding proteins has been exceeded. Foods grown on soil containing high levels of selenium cause toxicity, and excessive intakes of sodium cause hypertension in susceptible people.

SUMMARY

- Vitamins are organic nutrients with essential metabolic functions that are required in small amounts in the diet because they cannot be synthesized by the body. The lipid-soluble vitamins (A, D, E, and K) are hydrophobic molecules requiring normal fat absorption for their absorption and the avoidance of deficiency.
- Vitamin A (retinol), present in meat, and the provitamin (β -carotene), found in plants, form retinaldehyde, utilized in vision, and retinoic acid, which acts in the control of gene expression.
- Vitamin D is a steroid prohormone yielding the active hormone calcitriol, which regulates calcium and phosphate metabolism; deficiency leads to rickets and osteomalacia. It has a role in controlling cell differentiation and insulin secretion.
- Vitamin E (tocopherol) is the most important lipid-soluble antioxidant in the body, acting in the lipid phase of membranes protecting against the effects of free radicals.
- Vitamin K functions acts as the cofactor of a carboxylase that acts on glutamate residues of precursor proteins of clotting factors and bone and other proteins to enable them to chelate calcium.
- The water-soluble vitamins act as enzyme cofactors. Thiamin is a cofactor in oxidative decarboxylation of α -keto acids and of transketolase in the pentose phosphate pathway. Riboflavin and niacin are important cofactors in oxidoreduction reactions, present in flavoprotein enzymes and in NAD and NADP, respectively.
- Pantothenic acid is present in coenzyme A and acyl carrier protein, which act as carriers of acyl groups in metabolic reactions.

- Vitamin B₆ as pyridoxal phosphate is the coenzyme for several enzymes of amino acid metabolism, including the transaminases, and of glycogen phosphorylase. Biotin is the coenzyme for several carboxylase enzymes.
- Vitamin B₁₂ and folate provide one-carbon residues for DNA synthesis and other reactions; deficiency results in megaloblastic anemia.
- Vitamin C is a water-soluble antioxidant that maintains vitamin E and many metal cofactors in the reduced state.
- Inorganic mineral elements that have a function in the body must be provided in the diet. When intake is insufficient, deficiency may develop, and excessive intakes may be toxic.

REFERENCES

- Bender DA: *Nutritional Biochemistry of the Vitamins*, 2nd ed. Cambridge University Press, 2003.
- Bender DA, Bender AE: *Nutrition: A Reference Handbook*. Oxford University Press, 1997.
- Department of Health: *Dietary Reference Values for Food Energy and Nutrients for the United Kingdom*. Her Majesty's Stationery Office, 1991.
- FAO/WHO: *Human Vitamin and Mineral Requirements: Report of a Joint FAO/WHO Expert Consultation: Bangkok, Thailand*. Food and Nutrition Division of the United Nations Food and Agriculture Organization, 2000.
- Geissler C, Powers HJ: *Human Nutrition*, 12th ed. Elsevier, 2010.
- Gibney MJ, Lanham-New S, Cassidy A, et al: *Introduction to Human Nutrition, The Nutrition Society Textbook Series*, 2nd ed. Wiley-Blackwell, 2009.
- Institute of Medicine: *Dietary Reference Intakes for Calcium, Phosphorus, Magnesium, Vitamin D and Fluoride*. National Academy Press, 1997.
- Institute of Medicine: *Dietary Reference Values for Thiamin, Riboflavin, Niacin, Vitamin B6, Folate, Vitamin B12, Pantothenic Acid, Biotin and Choline*. National Academy Press, 2000.
- Institute of Medicine: *Dietary Reference Values for Vitamin C, Vitamin E, Selenium and Carotenoids*. National Academy Press, 2000.
- Institute of Medicine: *Dietary Reference Intakes for Vitamin A, Vitamin K, Arsenic, Boron, Chromium, Copper, Iodine, Iron, Manganese, Molybdenum, Nickel, Silicon, Vanadium and Zinc*. National Academy Press, 2001.
- Scientific Advisory Committee on Nutrition of the Food Standards Agency: *Folate and Disease Prevention*. The Stationery Office, 2006.

Free Radicals & Antioxidant Nutrients

David A. Bender, PhD

OBJECTIVES

After studying this chapter, you should be able to:

- Describe the damage caused to DNA, lipids, and proteins by free radicals, and the diseases associated with radical damage.
- Describe the main sources of oxygen radicals in the body.
- Describe the mechanisms and dietary factors that protect against radical damage.
- Explain how antioxidants can also act as pro-oxidants, and why intervention trials of antioxidant nutrients have generally yielded disappointing results.

BIOMEDICAL IMPORTANCE

Free radicals are formed in the body under normal conditions. They cause damage to nucleic acids, proteins, and lipids in cell membranes and plasma lipoproteins. This can cause cancer, atherosclerosis and coronary artery disease, and autoimmune diseases. Epidemiological and laboratory studies have identified a number of protective antioxidant nutrients: selenium, vitamins C and E, β -carotene, and other carotenoids, and a variety of polyphenolic compounds derived from plant foods. Many people take supplements of one or more antioxidant nutrients. However, intervention trials show little benefit of antioxidant supplements except among people who were initially deficient, and many trials of β -carotene and vitamin E have shown increased mortality among those taking the supplements.

Free Radical Reactions Are Self-Perpetuating Chain Reactions

Free radicals are highly reactive molecular species with an unpaired electron; they persist for only a very short time (of the order of 10^{-9} to 10^{-12} seconds) before they collide with another molecule and either abstract or donate an electron in order to achieve stability. In so doing, they generate a new radical from the molecule with which they collided. The main way in which a free radical can be quenched, so terminating this chain reaction, is if two radicals react together, when the unpaired electrons can become paired in one or other of the parent molecules. This is a rare occurrence, because of the very short half-life of an individual radical and the very low concentrations of radicals in tissues.

The most damaging radicals in biological systems are oxygen radicals (sometimes called reactive oxygen species)—especially superoxide, $\cdot\text{O}_2^-$, hydroxyl, $\cdot\text{OH}$, and perhydroxyl, $\cdot\text{O}_2\text{H}$. Tissue damage caused by oxygen radicals is often called oxidative damage, and factors that protect against oxygen radical damage are known as antioxidants.

Radicals Can Damage DNA, Lipids, & Proteins

Interaction of radicals with bases in DNA can lead to chemical changes that, if not repaired (see Chapter 35), may be inherited in daughter cells. Radical damage to unsaturated fatty acids in cell membranes and plasma lipoproteins leads to the formation of lipid peroxides, then highly reactive dialdehydes that can chemically modify proteins and nucleic acid bases. Proteins are also subject to direct chemical modification by interaction with radicals. Oxidative damage to tyrosine residues in proteins can lead to the formation of dihydroxyphenylalanine that can undergo nonenzymic reactions leading to further formation of oxygen radicals (**Figure 45-1**).

The total body radical burden can be estimated by measuring the products of lipid peroxidation. Lipid peroxides can be measured by the ferrous oxidation in xylenol orange (FOX) assay. Under acidic conditions, they oxidize Fe^{2+} to Fe^{3+} , which forms a chromophore with xylenol orange. The dialdehydes formed from lipid peroxides can be measured by reaction with thiobarbituric acid, when they form a red fluorescent adduct—the results of this assay are generally reported as total thiobarbituric acid reactive substances, TBARS. Peroxidation of n-6 polyunsaturated fatty acids leads to the formation of pentane, and

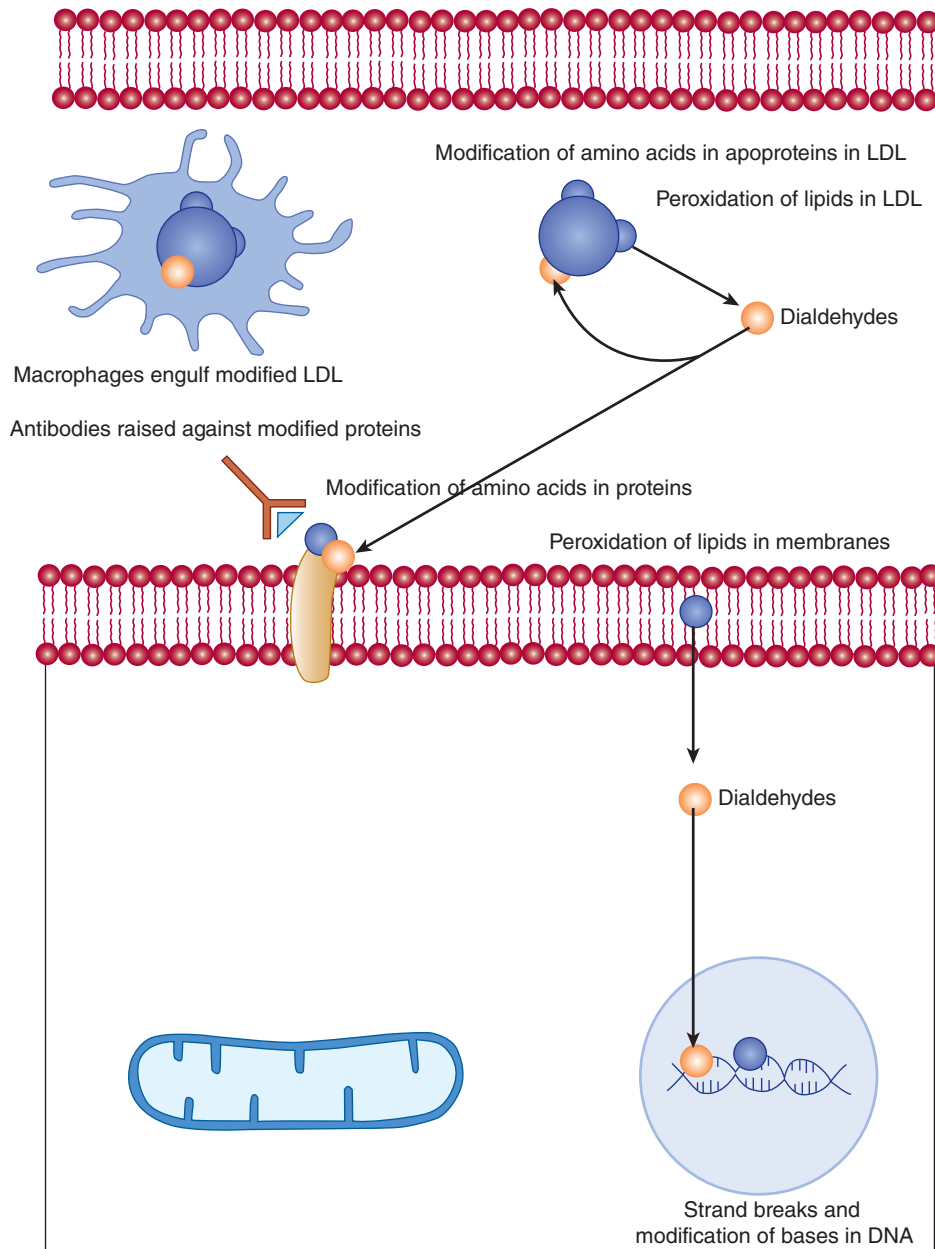

FIGURE 45-1 Tissue damage by radicals.

of n-3 polyunsaturated fatty acids to ethane, both of which can be measured in exhaled air.

Radical Damage May Cause Mutations, Cancer, Autoimmune Disease, & Atherosclerosis

Radical damage to DNA in germline cells in ovaries and testes can lead to heritable mutations; in somatic cells, the result may be initiation of cancer. The dialdehydes formed as a result of radical-induced lipid peroxidation in cell membranes can also modify bases in DNA.

Chemical modification of amino acids in proteins, either by direct radical action or as a result of reaction with the products

of radical-induced lipid peroxidation, leads to proteins that are recognized as nonself by the immune system. The resultant antibodies will also cross-react with normal tissue proteins, so initiating autoimmune disease.

Chemical modification of the proteins or lipids in plasma low-density lipoprotein (LDL) leads to abnormal LDL that is not recognized by the liver LDL receptors, and so is not cleared by the liver. The modified LDL is taken up by macrophage scavenger receptors. Lipid-engorged macrophages infiltrate under blood vessel endothelium (especially when there is already some damage to the endothelium), and are killed by the high content of unesterified cholesterol they have accumulated. This occurs in the development of atherosclerotic plaques, which, in extreme cases, can more or less completely occlude a blood vessel.

There Are Multiple Sources of Oxygen Radicals in the Body

Ionizing radiation (x-rays and UV) can lyse water, leading to the formation of hydroxyl radicals. Transition metal ions, including Cu^+ , Co^{2+} , Ni^{2+} , and Fe^{2+} can react nonenzymically with oxygen or hydrogen peroxide, again leading to the formation of hydroxyl radicals. Nitric oxide (an important compound in cell signaling, originally described as the endothelium-derived relaxation factor) is itself a radical, and, more importantly, can react with superoxide to yield peroxynitrite, which decays to form hydroxyl radicals (**Figure 45–2**).

The respiratory burst of activated macrophages (see Chapter 53) is increased utilization of glucose via the pentose phosphate pathway (see Chapter 20) to reduce NADP^+ to NADPH, and increased utilization of oxygen to oxidize NADPH to produce oxygen (and halogen) radicals as cytotoxic

agents to kill phagocytosed microorganisms. The respiratory burst oxidase (NADPH oxidase) is a flavoprotein that reduces oxygen to superoxide:



Plasma markers of radical damage to lipids increase considerably in response to even a mild infection.

The oxidation of reduced flavin coenzymes in the mitochondrial (see Chapter 13) and microsomal electron transport chains proceeds through a series of steps in which the flavin semiquinone radical is stabilized by the protein to which it is bound, and forms oxygen radicals as transient intermediates. Although the final products are not radicals, because of the unpredictable nature of radicals there is considerable “leakage” of radicals, and some 3% to 5% of the daily consumption of 30 mol of oxygen by an adult human being is converted to singlet oxygen, hydrogen peroxide, and superoxide, perhydroxyl, and

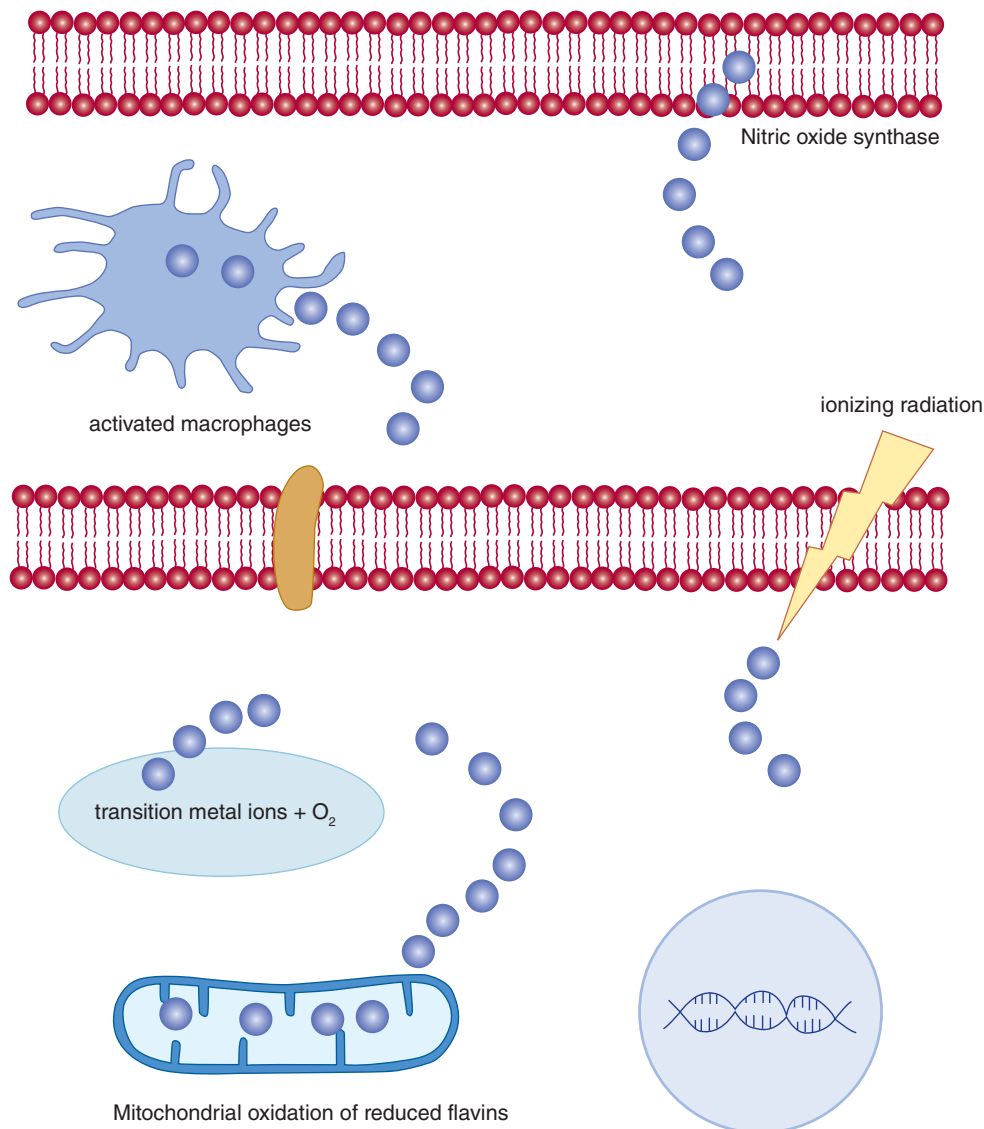

FIGURE 45–2 Sources of radicals.

hydroxyl radicals, rather than undergoing complete reduction to water. This results in daily production of about 1.5 mol of reactive oxygen species.

There Are Various Mechanisms of Protection Against Radical Damage

The metal ions that undergo nonenzymic reaction to form oxygen radicals are not normally free in solution, but are bound to either the proteins for which they provide the prosthetic group, or to specific transport and storage proteins, so that they are unreactive. Iron is bound to transferrin, ferritin, and hemosiderin, copper to ceruloplasmin, and other metal ions are bound to metallothionein. This binding to transport proteins that are too large to be filtered in the kidneys also prevents loss of metal ions in the urine.

Superoxide is produced both accidentally and also as the reactive oxygen species required for a number of enzyme-catalyzed reactions. A family of superoxide dismutases catalyze the reaction between superoxide and protons to yield oxygen and hydrogen peroxide:



The hydrogen peroxide is then removed by catalase and various peroxidases: $2\text{H}_2\text{O}_2 \rightarrow 2\text{H}_2\text{O} + \text{O}_2$. Most enzymes that produce and require superoxide are contained in the peroxisomes, together with superoxide dismutase, catalase, and peroxidases.

The peroxides that are formed by radical damage to lipids in membranes and plasma lipoproteins are reduced to hydroxy fatty acids by glutathione peroxidase, a selenium-dependent enzyme (hence the importance of adequate selenium intake to maximize antioxidant activity), and the oxidized glutathione is reduced by NADPH-dependent glutathione reductase (see Figure 20-3). Lipid peroxides are also reduced to fatty acids by reaction with vitamin E, forming the tocopheroxyl radical, which is relatively stable, since the unpaired electron can be located in any one of three positions in the molecule (Figure 45-3). The tocopheroxyl radical persists long enough to undergo reduction back to tocopherol by reaction with vitamin C at the surface of the cell or lipoprotein (see Figure 44-6). The resultant monodehydroascorbate radical then undergoes enzymic reduction back to ascorbate or a nonenzymic reaction of 2 mol of monodehydroascorbate to yield 1 mol each of ascorbate and dehydroascorbate.

Ascorbate, uric acid and a variety of polyphenols derived from plant foods act as water-soluble radical trapping antioxidants, forming relatively stable radicals that persist long enough

to undergo reaction to nonradical products. Ubiquinone and carotenes similarly act as lipid-soluble radical-trapping antioxidants in membranes and plasma lipoproteins.

The Antioxidant Paradox—Antioxidants Can Also Be Pro-Oxidants

Although ascorbate is an antioxidant, reacting with superoxide and hydroxyl to yield monodehydroascorbate and hydrogen peroxide or water, it can also be a source of superoxide radicals by reaction with oxygen, and hydroxyl radicals by reaction with Cu^{2+} ions (Table 45-1). However, these pro-oxidant actions require relatively high concentrations of ascorbate, which are unlikely to be reached in tissues, since once the plasma concentration of ascorbate reaches about 30 mmol/L, the renal threshold is reached, and at intakes above about 100 to 120 mg/d the vitamin is excreted in the urine quantitatively with intake.

A considerable body of epidemiological evidence suggests that carotene is protective against lung and other cancers. However, two major intervention trials in the 1990s showed an increase in death from lung (and other) cancer among people given supplements of β -carotene. The problem is that although β -carotene is indeed a radical-trapping antioxidant under conditions of low partial pressure of oxygen, as in most tissues, at high partial pressures of oxygen (as in the lungs) and especially in high concentrations, β -carotene is an autocatalytic pro-oxidant, and hence can initiate radical damage to lipids and proteins.

Epidemiological evidence also suggests that vitamin E is protective against atherosclerosis and cardiovascular disease. However, meta-analysis of intervention trials with vitamin E shows increased mortality among those taking (high dose) supplements. These trials have all used α -tocopherol, and it is possible that the other vitamers of vitamin E that are present in foods, but not the supplements, may be important. In vitro, plasma lipoproteins form less cholesterol ester hydroperoxide when incubated with sources of low concentrations of perhydroxyl radicals when vitamin E has been removed than when it is present. The problem seems to be that vitamin E acts as an antioxidant by forming a stable radical that persists long enough to undergo metabolism to nonradical products. This means that the radical also persists long enough to penetrate deeper in to the lipoprotein, causing further radical damage, rather than interacting with a water-soluble antioxidant at the surface of the lipoprotein.

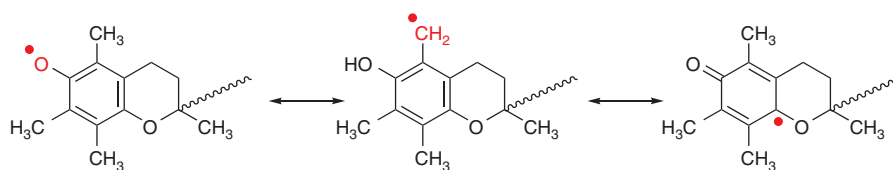

FIGURE 45-3 Delocalisation of the unpaired electron in the tocopheroxyl radical.

TABLE 45-1 Antioxidant and Pro-Oxidant Roles of Vitamin C

Antioxidant roles:
Ascorbate + $\cdot\text{O}_2^- \rightarrow \text{H}_2\text{O}_2$ + monodehydroascorbate; catalase and peroxidases catalyze the reaction: $2\text{H}_2\text{O}_2 \rightarrow 2\text{H}_2\text{O} + \text{O}_2$
Ascorbate + $\cdot\text{OH} \rightarrow \text{H}_2\text{O}$ + monodehydroascorbate
Pro-oxidant roles:
Ascorbate + $\text{O}_2 \rightarrow \cdot\text{O}_2^-$ + monodehydroascorbate
Ascorbate + $\text{Cu}^{2+} \rightarrow \text{Cu}^+$ + monodehydroascorbate;
$\text{Cu}^+ + \text{H}_2\text{O}_2 \rightarrow \text{Cu}^{2+} + \text{OH}^- + \cdot\text{OH}$

Nitric oxide and other radicals are important in cell signaling, and especially in signaling for programmed cell death (apoptosis) of cells that have suffered DNA and other damage. It is likely that high concentrations of antioxidants, so far from protecting against tissue damage, may quench the signaling radicals, and so permit the continued survival of damaged cells, so increasing, rather than decreasing, the risk of cancer development.

SUMMARY

- Free radicals are highly reactive molecular species with an unpaired electron. They can react with, and modify, proteins, nucleic acids and fatty acids in cell membranes and plasma lipoproteins.
- Radical damage to lipids and proteins in plasma lipoproteins is a factor in the development of atherosclerosis and coronary artery disease; radical damage to nucleic acids may induce heritable mutations and cancer; radical damage to proteins may lead to the development of autoimmune diseases.
- Oxygen radicals arise as a result of exposure to ionizing radiation, nonenzymic reactions of transition metal ions, the respiratory burst of activated macrophages, and the normal oxidation of reduced flavin coenzymes.
- Protection against radical damage is afforded by enzymes that remove superoxide ions and hydrogen peroxide, enzymic reduction of lipid peroxides linked to oxidation of glutathione, nonenzymic reaction of lipid peroxides with vitamin E, and reaction of radicals with compounds such as vitamins C and E, carotene, ubiquinone, uric acid, and dietary polyphenols that form relatively stable radicals that persist long enough to undergo reaction to nonradical products.
- Except in people who were initially deficient, intervention trials of vitamin E and β -carotene have generally shown increased mortality among those taking the supplements.

β -Carotene is only an antioxidant at low concentrations of oxygen; at higher concentrations of oxygen it is an autocatalytic pro-oxidant. Vitamin E forms a stable radical that is capable of either undergoing reaction with water-soluble antioxidants or penetrating further into lipoproteins and tissues, so increasing radical damage.

- Radicals are important in cell signaling, and especially in signaling for apoptosis of cells that have suffered DNA damage. It is likely that high concentrations of antioxidants, so far from protecting against tissue damage, may quench the signaling radicals, and so permit the continued survival of damaged cells, so increasing, rather than decreasing, the risk of cancer development.

REFERENCES

- Asplund K: Antioxidant vitamins in the prevention of cardiovascular disease: a systematic review. *J Intern Med* 2002;251:372.
- Bjelakovic G, Nikolova D, Gluud LL, et al: Mortality in randomised trials of antioxidant supplements for primary and secondary prevention. *JAMA* 2007;297:842.
- Burton G, Ingold K: β -Carotene, an unusual type of lipid antioxidant. *Science* 1984;224:569.
- Carr A, Frei B: Does vitamin C act as a pro-oxidant under physiological conditions? *FASEB J* 1999;13:1007.
- Cordero Z, Drogan D, Weikert C, et al: Vitamin E and risk of cardiovascular diseases: a review of epidemiologic and clinical trial studies. *Crit Rev Food Sci Nutr* 2010;50:420.
- Dotan Y, Lichtenberg D, Pinchuk I: No evidence supports vitamin E indiscriminate supplementation. *Biofactors* 2009;35:469.
- Halliwell B, Gutteridge JM, Cross CE: Free radicals, antioxidants and human disease: where are we now? *J Lab Clin Med* 1992;119:598.
- Imlay JA: Cellular defenses against superoxide and hydrogen peroxide. *Ann Rev Biochem* 2008;77:755.
- Imlay JA: Pathways of oxidative damage. *Ann Rev Microbiol* 2003;57:395.
- Klaunig JE, Kamendulis LM: The role of oxidative stress in carcinogenesis. *Ann Rev Pharm Tox* 2004;44:239.
- Miller ER, Pastor-Barriuso R, Dalal D, et al: Meta-analysis: high-dosage vitamin E supplementation may increase all-cause mortality. *Ann Intern Med* 2005;142:37.
- Omenn GS, Goodman GE, Thornquist MD, et al: Effects of a combination of beta carotene and vitamin A on lung cancer and cardiovascular disease. *N Engl J Med* 1996;334:1150.
- Various authors: Symposium: antioxidant vitamins and β -carotene in disease prevention. *Amer J Clin Nutr* 1995;62(suppl 6):1299S.
- Various authors: Symposium proceedings: molecular mechanisms of protective effects of vitamin E in atherosclerosis. *J Nutr* 2001;131:366.
- Zeisel SH: Antioxidants suppress apoptosis. *J Nutr* 2004;134:3179S.

Glycoproteins

David A. Bender, PhD & Robert K. Murray, MD, PhD

OBJECTIVES

After studying this chapter, you should be able to:

- Explain the importance of glycoproteins in health and disease.
- Describe the principal sugars found in glycoproteins.
- Describe the major classes of glycoproteins (*N*-linked, *O*-linked, and GPI-linked).
- Describe the major features of the pathways of biosynthesis and degradation of glycoproteins.
- Explain the importance of advanced glycation end-products in causing tissue damage in diabetes mellitus.
- Explain how many microorganisms, such as influenza virus, attach to cell surfaces via sugar chains.

BIOMEDICAL IMPORTANCE

The **glycoproteins** are proteins that contain oligosaccharide chains (glycans) covalently bound to amino acids. At least half of all eukaryotic proteins have sugars attached, so that **glycosylation** (the enzymic attachment of sugars) is the most frequent posttranslational modification of proteins. Many proteins also undergo reversible glycosylation with a single sugar (*N*-acetylglucosamine) bound to a serine or threonine residue that is also a site for reversible phosphorylation. This is an important mechanism of metabolic regulation. Nonenzymic attachment of sugars to proteins can also occur, and is referred to as **glycation**. This process can have serious pathological consequences (eg, in poorly controlled diabetes mellitus).

Glycoproteins are one class of **glycoconjugate** or **complex carbohydrate**—equivalent terms that are used to denote molecules containing one or more carbohydrate chains covalently linked to protein (to form glycoproteins or proteoglycans) or lipid (to form glycolipids). (**Proteoglycans** are discussed in Chapter 50 and **glycolipids** in Chapter 21.) Almost all the human **plasma proteins**, with the notable exception of albumin, are glycoproteins. Many **proteins of cellular membranes** (see Chapter 40) contain substantial amounts of carbohydrate, and many membrane proteins are anchored to the lipid bilayer by a glycan chain. A number of the **blood group substances** are glycoproteins, whereas others are glycosphingolipids. Many peptide **hormones** are glycoproteins. A major problem in cancer is **metastasis** (see Chapter 56) and evidence is accumulating that alterations in the structures of glycoproteins and other glycoconjugates on the surface of cancer cells are important in metastasis.

GLYCOPROTEINS OCCUR WIDELY & PERFORM NUMEROUS FUNCTIONS

Glycoproteins occur in most organisms, from bacteria to human beings. Many viruses also contain glycoproteins, some of which play key roles in viral attachment to host cells (eg, HIV-1 and influenza A virus). The glycoproteins have a wide range of functions (**Table 46–1**); their carbohydrate content ranges from 1% to over 85% by weight. The glycan structures of glycoproteins change in response to signals involved in cell differentiation, normal physiology, and neoplastic transformation. This is the result of different expression patterns of glycosyltransferases under different conditions. **Table 46–2** lists some of the major functions of the glycan chains of glycoproteins.

OLIGOSACCHARIDE CHAINS ENCODE BIOLOGICAL INFORMATION

The biological information in the sequence and linkages of sugars in glycans differs from that in DNA, RNA, and proteins in one important respect; it is secondary rather than primary information. The pattern of glycosylation of a given protein depends less on its amino acid sequence than on the pattern of expression of the various **glycosyltransferases** in the cell that are involved in glycoprotein synthesis, the affinity of

TABLE 46-1 Some Functions Served by Glycoproteins

Function	Glycoproteins
Structural molecule	Collagens
Lubricant and protective agent	Mucins
Transport molecule	Transferrin, ceruloplasmin
Immunologic molecule	Immunoglobulins, histocompatibility antigens
Hormone	Chorionic gonadotropin, thyroid-stimulating hormone (TSH)
Enzyme	Various, eg, alkaline phosphatase
Cell attachment-recognition site	Various proteins involved in cell-cell (eg, sperm-oocyte), virus-cell, bacterium-cell, and hormone-cell interactions
Antifreeze	Plasma proteins of cold-water fish
Interact with specific carbohydrates	Lectins, selectins (cell adhesion lectins), antibodies
Receptor	Cell surface proteins involved in hormone and drug action
Regulate folding of proteins that are exported from the cell	Calnexin, calreticulin
Regulation of differentiation and development	Notch and its analogs, key proteins in development
Hemostasis (and thrombosis)	Specific glycoproteins on the surface membranes of platelets

the different glycosyltransferases for their carbohydrate substrates, and the relative availability of the different carbohydrate substrates. Because of this there is **microheterogeneity** of glycoproteins. Not all of the glycan chains of a given glycoprotein are complete; some are truncated.

The information from the sugars is expressed via interactions between the glycans and proteins such as **lectins** (see below) or other molecules. These interactions lead to changes

TABLE 46-2 Some Functions of the Oligosaccharide Chains of Glycoproteins

<ul style="list-style-type: none"> • Change physicochemical properties of the protein such as solubility, viscosity, charge, conformation, denaturation.
<ul style="list-style-type: none"> • Provide binding sites for various molecules, as well as bacteria, viruses, and some parasites.
<ul style="list-style-type: none"> • Provide cell surface recognition signals.
<ul style="list-style-type: none"> • Protect against proteolysis.
<ul style="list-style-type: none"> • Ensure correct folding of proteins that are exported from the cell and target incorrectly folded proteins for transport from the endoplasmic reticulum back to the cytosol for catabolism.
<ul style="list-style-type: none"> • Protect peptide hormones and other plasma proteins against clearance by the liver.
<ul style="list-style-type: none"> • Permit anchoring of extracellular proteins in the cell membrane, and of intracellular proteins inside subcellular organelles such as endoplasmic reticulum and Golgi.
<ul style="list-style-type: none"> • Direct intracellular migration, sorting and secretion of proteins.
<ul style="list-style-type: none"> • Affect embryonic development and cell and tissue differentiation.
<ul style="list-style-type: none"> • May affect sites of metastases selected by cancer cells.

of the cellular activity. Thus, deciphering the so-called **sugar code of life** (one of the principal aims of **glycomics**) entails elucidating all of the interactions that sugars and sugar-containing molecules participate in, and the results of these interactions on cellular behavior.

VARIOUS TECHNIQUES ARE AVAILABLE FOR DETECTION, PURIFICATION, STRUCTURAL ANALYSIS & SYNTHESIS OF GLYCOPROTEINS

The principal methods used in the detection, purification, and structural analysis of glycoproteins are listed in **Table 46-3**. The conventional methods used to purify proteins and enzymes are also applicable to the purification of glycoproteins. Once a glycoprotein has been purified, the use of **mass spectrometry** and **high-resolution NMR spectroscopy** and glycan **micro-arrays** can often identify the structures of its glycan chains. Analysis of glycoproteins is complicated by the fact that they often exist as **glycoforms**—proteins with identical amino acid sequences but showing micro-heterogeneity of the glycan chains. The precise natures of the linkages between the sugars of glycoproteins are important in determining their structures and functions.

Advances in synthetic chemistry have allowed the synthesis of complex glycans that can be tested for their biological

TABLE 46-3 Some Important Methods Used to Study Glycoproteins

Method	Use
Periodic acid–Schiff reagent	Detects glycoproteins as pink bands after electrophoretic separation.
Incubation of cultured cells with a radioactive sugar	Leads to detection of glycoproteins as radioactive bands after electrophoretic separation.
Treatment with appropriate endo- or exoglycosidase or phospholipases	Resultant shifts in electrophoretic migration help distinguish among proteins with <i>N</i> -glycan, <i>O</i> -glycan, or GPI linkages and also between high mannose and complex <i>N</i> -glycans.
Sepharose-lectin column chromatography	To purify glycoproteins or glycopeptides that bind the lectin used.
Compositional analysis following acid hydrolysis	Identifies that sugars that the glycoprotein contains and their stoichiometry.
Mass spectrometry	Provides information on molecular mass, composition, sequence, and sometimes branching of a glycan chain.
NMR spectroscopy	Identifies specific sugars, their sequence, linkages, and the anomeric nature of glycosidic linkages.
Methylation (linkage) analysis	Determines linkages between sugars.
Micro-arrays to detect glycan sequences	Allows detection of specific glycan sequences with a high throughput.

and pharmacological activity. In addition, methods have been developed that use organisms such as yeasts to synthesize and secrete human glycoproteins of therapeutic value (eg, erythropoietin) into their surrounding medium.

A number of **glycosidases** are useful in determining the structure and function of glycoproteins. **Exoglycosidases** such as **neuraminidases** and **galactosidases** catalyze the hydrolysis of terminal *N*-acetylneuraminic acid and galactose. Their sequential use removes terminal *N*-acetyl neuraminic acid and penultimate galactose residues from most glycoproteins. **Endoglycosidases** cleave the oligosaccharide chains internally, at specific *N*-acetylglucosamine residues close to the polypeptide backbone. They are useful in releasing large oligosaccharide chains for structural analyses.

EIGHT SUGARS PREDOMINATE IN HUMAN GLYCOPROTEINS

About 200 monosaccharides are found in nature; however, only eight are commonly found in the oligosaccharide chains of glycoproteins (Table 46–4 and Chapter 15). *N*-acetylneuraminic acid (NeuAc) is usually found at the termini of oligosaccharide chains, attached to subterminal galactose (Gal) or *N*-acetylgalactosamine (GalNAc) residues. The other sugars listed are generally found in more internal positions. **Sulfate** is often found in glycoproteins, usually attached to Gal, GalNAc, or GlcNAc.

SUGAR NUCLEOTIDES ACT AS SUGAR DONORS IN MANY BIOSYNTHETIC REACTIONS

In most biosynthetic reactions, it is not the free or phosphorylated sugar that is involved, but rather the corresponding **sugar nucleotide** (see Figure 18–2). The sugar nucleotides involved in the biosynthesis of glycoproteins are listed in Table 46–4; some contain UDP and others guanosine diphosphate (GDP) or cytidine monophosphate (CMP).

Most nucleotide sugars are formed in the cytosol, generally from reactions involving the corresponding nucleoside triphosphate. CMP-sialic acids are formed in the nucleus. Formation of uridine diphosphate galactose (UDP-Gal) requires two reactions in mammalian tissues, catalyzed by UDP-glucose pyrophosphorylase and UDP-glucose epimerase:

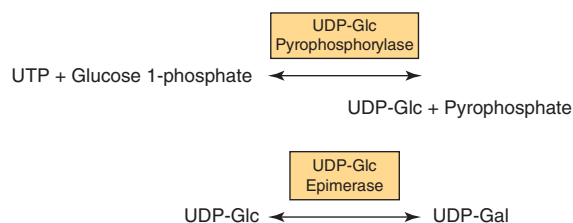
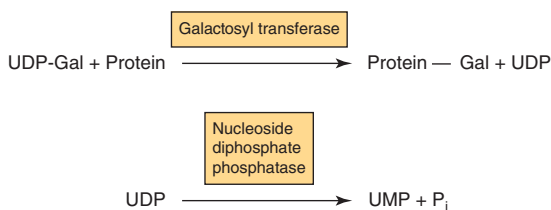

TABLE 46–4 The Principal Sugars Found in Human Glycoproteins^a

Sugar	Type	Abbreviation	Sugar Nucleotide	Comments
Galactose	Hexose	Gal	UDP-Gal	Often found subterminal to NeuAc in <i>N</i> -linked glycoproteins. Also, found in the core trisaccharide of proteoglycans.
Glucose	Hexose	Glc	UDP-Glc	Present during the biosynthesis of <i>N</i> -linked glycoproteins but not usually present in mature glycoproteins. Present in some clotting factors.
Mannose	Hexose	Man	GDP-Man	Common sugar in <i>N</i> -linked glycoproteins.
<i>N</i> -Acetylneuraminic acid	Sialic acid (nine C atoms)	NeuAc	CMP-NeuAc	Often the terminal sugar in both <i>N</i> - and <i>O</i> -linked glycoproteins. Other types of sialic acid are also found, but NeuAc is the major species found in humans. Acetyl groups may also occur as <i>O</i> -acetyl species as well as <i>N</i> -acetyl.
Fucose	Deoxyhexose	Fuc	GDP-Fuc	May be external in both <i>N</i> - and <i>O</i> -linked glycoproteins or internal, linked to the GlcNAc residue attached to Asn in <i>N</i> -linked species. Can also occur internally attached to the OH of Ser (eg, in t-PA and certain clotting factors).
<i>N</i> -Acetylgalactosamine	Aminohexose	GalNAc	UDP-GalNAc	Present in both <i>N</i> - and <i>O</i> -linked glycoproteins.
<i>N</i> -Acetylglucosamine	Aminohexose	GlcNAc	UDP-GlcNAc	The sugar attached to the polypeptide chain via Asn in <i>N</i> -linked glycoproteins; also found at other sites in the oligosaccharides of these proteins. Many nuclear proteins have GlcNAc attached to the OH of Ser or Thr as a single sugar.
Xylose	Pentose	Xyl	UDP-Xyl	Xyl is attached to the OH of Ser in many proteoglycans. Xyl in turn is attached to two Gal residues, forming a link trisaccharide. Xyl is also found in t-PA and certain clotting factors.

^aThe structures of these sugars are illustrated in Chapter 15.

Because many glycosylation reactions occur within the lumen of the Golgi apparatus, **carrier systems** (permeases and transporters) are required to transport nucleotide sugars across the Golgi membrane. There are systems for transporting UDP-Gal, GDP-Man, and CMP-NeuAc. They are **antiporter** systems; the influx of one molecule of sugar nucleotide is balanced by the efflux of one molecule of the corresponding nucleotide (UMP, GMP, or CMP) formed from the sugar nucleotide sugars. This mechanism ensures an adequate concentration of each nucleotide sugar inside the Golgi apparatus. UMP is formed from UDP-Gal in reactions catalyzed by galactosyl transferase and nucleoside diphosphate phosphatase:



THE MAMMALIAN ASIALOGLYCOPROTEIN RECEPTOR IS INVOLVED IN CLEARANCE OF GLYCOPROTEINS FROM PLASMA BY HEPATOCYTES

Many peptide hormones, and most plasma proteins are glycoproteins. Treatment of the protein with neuraminidase removes the terminal *N*-acetylneuraminic acid moiety, exposing the subterminal galactose residue. This asialoglycoprotein is cleared from the circulation very much faster than the intact glycoprotein. Liver cells contain an **asialoglycoprotein receptor** that recognizes the galactose moiety of many desialylated plasma proteins and leading to their endocytosis and catabolism.

LECTINS CAN BE USED TO PURIFY GLYCOPROTEINS & TO INVESTIGATE THEIR FUNCTIONS

Lectins are **carbohydrate-binding proteins** that agglutinate cells or precipitate glycoconjugates; a number of lectins are themselves glycoproteins. Immunoglobulins that react with sugars are not considered to be lectins. Lectins contain at least two sugar-binding sites; proteins with only a single sugar-binding site will not agglutinate cells or precipitate glycoconjugates. The specificity of a lectin is usually defined by the sugars that are best able to inhibit its ability to cause

TABLE 46-5 Some Important Lectins

Lectins	Examples or Comments
Legume lectins	Concanavalin A, pea lectin.
Wheat germ agglutinin	Widely used in studies of surfaces of normal cells and cancer cells.
Ricin	Cytotoxic glycoprotein derived from seeds of the castor plant.
Bacterial toxins	Heat-labile enterotoxin of <i>E. coli</i> and cholera toxin
Influenza virus hemagglutinin	Responsible for host-cell attachment and membrane fusion.
C-type lectins	Characterized by a Ca ²⁺ -dependent carbohydrate recognition domain (CRD); includes the mammalian asialoglycoprotein receptor, the selectins, and the mannose-binding protein.
S-type lectins	β-Galactoside-binding animal lectins with roles in cell-cell and cell-matrix interactions.
P-type lectins	Mannose 6-P receptor.
I-type lectins	Members of the immunoglobulin super-family, for example, sialoadhesin mediating adhesion of macrophages to various cells.

agglutination or precipitation. Lectins were first discovered in plants and microbes, but many lectins of animal origin are now known. The mammalian asialoglycoprotein receptor described above is such an animal lectin. Plant lectins were formerly called **phytohaemagglutinins**, because of their ability to agglutinate red blood cells by reacting with the cell surface glycoproteins. Undenatured lectins in undercooked legumes can lead to severe stripping of the intestinal mucosa by agglutinating the mucosal cells. Some important lectins are listed in **Table 46-5**.

Numerous lectins have been purified and are commercially available; three plant lectins that have been widely used experimentally are listed in **Table 46-6**. They are used to purify glycoproteins, as tools for probing the glycoprotein profiles of cell surfaces, and as reagents for generating mutant cells deficient in certain enzymes involved in the biosynthesis of oligosaccharide chains.

TABLE 46-6 Three Plant Lectins and the Sugars with Which They Interact

Lectin	Abbreviation	Sugars
Concanavalin A	ConA	Man and Glc
Soybean lectin		Gal and GalNAc
Wheat germ agglutinin	WGA	Glc and NeuAc

THERE ARE THREE MAJOR CLASSES OF GLYCOPROTEINS

Glycoproteins can be divided into three main groups, based on the nature of the linkage between the polypeptide and oligosaccharide chains (**Figure 46–1**); there are other minor classes of glycoprotein:

1. Those containing an **O-glycosidic linkage** (O-linked), involving the hydroxyl side chain of serine or threonine (and sometimes also tyrosine) and a sugar such as *N*-acetylgalactosamine (GalNAc-Ser[Thr])
2. Those containing an **N-glycosidic linkage** (N-linked), involving the amide nitrogen of asparagine and *N*-acetylglucosamine (GlcNAc-Asn)
3. Those linked to the carboxyl terminal amino acid of a protein via a phosphoryl-ethanolamine moiety joined to an oligosaccharide (glycan), which in turn is linked via glucosamine to phosphatidylinositol (PI). These are **glycosylphosphatidylinositol-anchored (GPI-anchored)** glycoproteins. Among other functions, they are involved in directing glycoproteins to the apical or basolateral areas of the plasma membrane (PM) of polarized epithelial cells (see Chapter 40 and below).

The number of oligosaccharide chains attached to one protein can vary from 1 to 30 or more, with the sugar chains ranging

from one or two residues in length to much larger structures. The glycan chain may be linear or branched. Many proteins contain more than one type of sugar chain; for instance, **glycophorin**, an important red cell membrane glycoprotein (see Chapter 53), contains both *O*- and *N*-linked oligosaccharides.

GLYCOPROTEINS CONTAIN SEVERAL TYPES OF O-GLYCOSIDIC LINKAGES

At least four subclasses of *O*-glycosidic linkages are found in human glycoproteins:

1. The **GalNAc-Ser(Thr)** linkage shown in Figure 46–1 is the predominant linkage. Usually a galactose or an *N*-acetylneuraminic acid residue is attached to the *N*-acetylgalactosamine, but many variations in the sugar compositions and lengths of such oligosaccharide chains are found. This type of linkage is found in **mucins** (see below).
2. **Proteoglycans** contain a **Gal-Gal-Xyl-Ser** trisaccharide (the so-called link trisaccharide).
3. **Collagens** (see Chapter 50) contain a **Gal-Hydroxylysine (Hyl)** linkage.
4. Many **nuclear and cytosolic proteins** contain side chains consisting of a single *N*-acetylglucosamine attached to a serine or threonine residue (**GlcNAc-Ser[Thr]**).

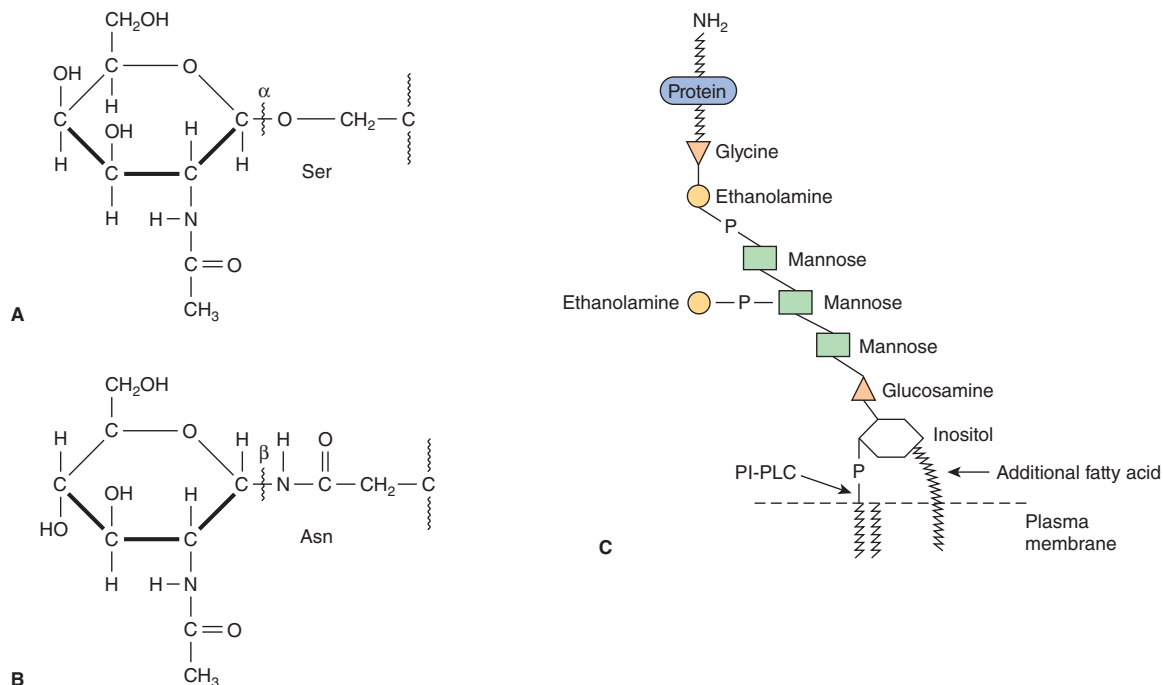

FIGURE 46–1 The three main types of glycoprotein. (A) an **O-linkage** (*N*-acetylgalactosamine to serine), (B) an **N-linkage** (*N*-acetylglucosamine to asparagine), and (C) a **glycosylphosphatidylinositol (GPI) linkage**. The GPI structure shown is that linking acetylcholinesterase to the plasma membrane of the human red blood cell. The site of action of PI-phospholipase C (PI-PLC), which releases the enzyme from membrane binding is indicated. This particular GPI contains an extra fatty acid attached to inositol and also an extra phosphoryl-ethanolamine moiety attached to the central of the mannose residue. Variations found among different GPI structures include the identity of the carboxyl terminal amino acid, the molecules attached to the mannose residues, and the precise nature of the lipid moiety.

Mucins Have a High Content of O-Linked Oligosaccharides & Exhibit Repeating Amino Acid Sequences

Mucins are glycoproteins with two distinctive characteristics: a high content of **O-linked oligosaccharides** (the carbohydrate content of mucins is generally more than 50%); and the presence of **variable numbers of tandem repeats (VNTRs)** of peptide sequence in the centre of their polypeptide backbones, to which the O-glycan chains are attached in clusters. These tandem repeat sequences are rich in serine, threonine, and proline; indeed up to 60% of the dietary requirement for threonine can be accounted for by the synthesis of mucins. Although O-glycans predominate, mucins often also contain a number of N-glycan chains. Some important properties of mucins are summarized in **Table 46–7**.

Both **secretory** and **membrane-bound** mucins occur. **Mucus** secreted by the gastrointestinal, respiratory, and reproductive tracts is a solution containing about 5% mucins. Secretory mucins generally have an oligomeric structure, with monomers linked by disulfide bonds, and hence a very high molecular mass. Mucus has a high **viscosity** and often forms a **gel** because of its content of mucins. The high content of O-glycans confers an extended structure. This is partly explained by steric interactions between the GalNAc moieties and adjacent amino acids, resulting in a chain-stiffening effect, so that the conformation of mucins often become rigid rods. Intermolecular noncovalent interactions between sugars on neighboring glycan chains contribute to gel formation. The high content of **NeuAc** and **sulfate** residues found in many mucins gives them a negative charge.

Mucins help to **lubricate** and form a **protective physical barrier** on epithelial surfaces. They are highly resistant to proteolysis because the density of oligosaccharide chains makes it difficult for **proteases** to access their polypeptide backbones.

Membrane-bound mucins participate in **cell-cell interactions**. They may also mask cell surface antigens. Many cancer cells form large amounts of mucins that mask surface antigens and protect the cancer cells from immune surveillance. Mucins also carry cancer-specific peptide and carbohydrate epitopes. Some of these have been used to stimulate an immune response against cancer cells.

TABLE 46–7 Some Properties of Mucins

Found in secretions of the gastrointestinal, respiratory, and reproductive tracts and also in membranes of various cells.
Exhibit high content of O-glycan chains, usually containing NeuAc.
Contain repeating amino acid sequences rich in serine, threonine, and proline.
Extended structure contributes to their high viscoelasticity.
Very resistant to proteolysis
Form a protective physical barrier on epithelial surfaces, are involved in cell-cell interactions, and may contain or mask certain surface antigens.

O-Linked Glycoproteins Are Synthesized by Sequential Addition of Sugars from Sugar Nucleotides

Because most glycoproteins are membrane-bound or secreted, their mRNA is usually translated on membrane-bound polyribosomes (see Chapter 37). The glycan chains are built up by the **sequential donation of sugars from sugar nucleotides**, catalyzed by **glycoprotein glycosyltransferases**. There are 41 different types of glycoprotein glycosyltransferases. Families of glycosyltransferases are named for the sugar nucleotide donor, and subfamilies on the basis of the linkage formed between the sugar and the acceptor substrate; transfer may occur with retention or inversion of the conformation at C-1 of the sugar. Binding of the sugar nucleotide to the enzyme causes a conformational change in the enzyme that permits binding of the acceptor substrate. Glycosyltransferases show a high degree of specificity for the acceptor substrate, typically acting only on the product of the preceding reaction. The different stages in glycan formation, and hence the different glycosyltransferases, are located in different regions of the Golgi, so that there is spatial separation of the different steps in the process. Not all of the glycan chains of a given glycoprotein are complete; some are truncated, leading to microheterogeneity. No consensus sequence is known to determine which serine and threonine residues are glycosylated, but the first sugar moiety incorporated is usually N-acetylgalactosamine. The major features of the biosynthesis of O-linked glycoproteins are summarized in **Table 46–8**.

N-LINKED GLYCOPROTEINS CONTAIN AN Asn-GLcNAc LINKAGE

N-Linked glycoproteins are the major class of glycoproteins, including both **membrane-bound** and **circulating** glycoproteins. They are distinguished by the presence of the asparagine—N-acetylglucosamine linkage (Figure 46–1). There are three major classes of N-linked oligosaccharides: **complex**, **high-mannose**, and **hybrid**. All three classes have the same branched pentasaccharide, $\text{Man}_3\text{GlcNAc}_2$, bound to asparagine, but differ in their outer branches (Figure 46–2).

TABLE 46–8 Summary of Main Features of O-Glycosylation

<ul style="list-style-type: none"> • Involves a battery of membrane-bound glycoprotein glycosyltransferases acting in a stepwise manner; each transferase is generally specific for a particular type of linkage.
<ul style="list-style-type: none"> • The enzymes involved are located in various subcompartments of the Golgi apparatus.
<ul style="list-style-type: none"> • Each glycosylation reaction involves the appropriate nucleotide sugar.
<ul style="list-style-type: none"> • Dolichol-P-P-oligosaccharide is not involved, nor are glycosidases; and the reactions are not inhibited by tunicamycin.
<ul style="list-style-type: none"> • O-Glycosylation occurs posttranslationally at certain Ser and Thr residues.

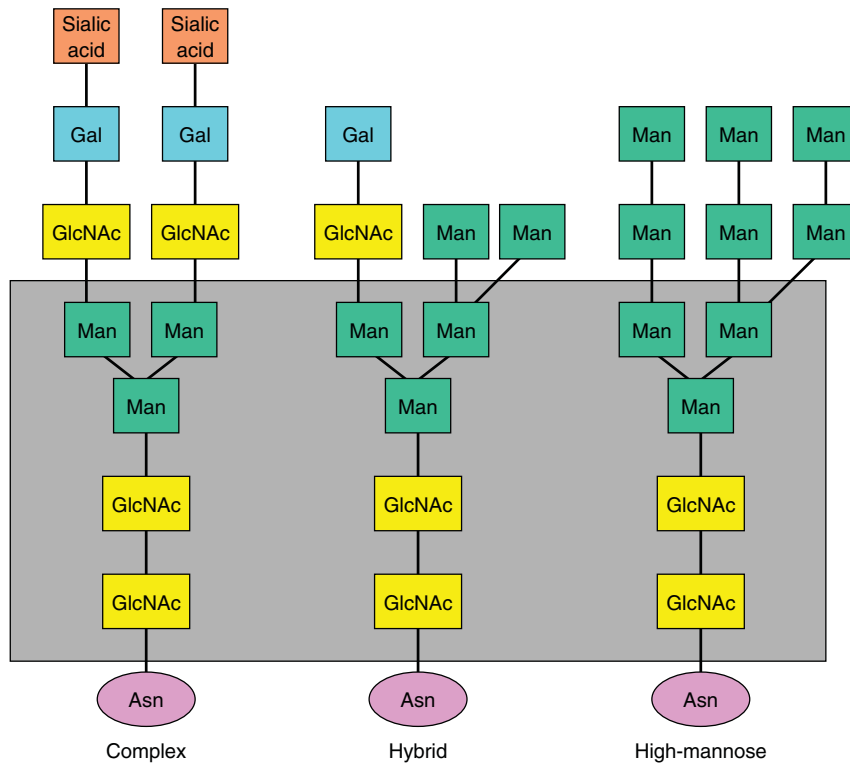

FIGURE 46-2 Structures of the major types of asparagine-linked oligosaccharides. The boxed area encloses the pentasaccharide core common to all *N*-linked glycoproteins.

Complex oligosaccharides contain two, three, four, or five outer branches. The oligosaccharide branches are often referred to as **antennae**, so that bi-, tri-, tetra-, and pentantennary structures may all be found. They generally contain terminal *N*-acetylneuraminic acid residues and underlying galactose and *N*-acetylglucosamine residues, the latter often constituting the disaccharide *N*-acetyllactosamine. Repeating ***N*-acetyllactosamine units**—[Gal β 1-3/4GlcNAc β 1-3] $_n$ (poly-*N*-acetyllactosaminoglycans)—are often found on *N*-linked glycan chains. I/i blood group substances belong to this class. A bewildering number of chains of the complex type exist, and that indicated in Figure 46-2 is only one of many. Other complex chains may terminate in galactose or fucose.

High-mannose oligosaccharides typically have two to six additional mannose residues linked to the pentasaccharide core. Hybrid molecules contain features of both of the other classes.

The Biosynthesis of *N*-Linked Glycoproteins Involves Dolichol-P-P-Oligosaccharide

The presence of the **common pentasaccharide** in *N*-linked glycoproteins is explained by the fact they share an initial common mechanism of biosynthesis, in which a branched oligosaccharide is synthesized attached to **dolichol pyrophosphate** (Figure 46-3) on the cytosolic side of the endoplasmic reticulum membrane, then translocated to the lumen of the endoplasmic reticulum, where it undergoes further glycosylation,

before the oligosaccharide chain is transferred by an oligosaccharyltransferase onto an asparagine residue of the acceptor apoglycoprotein as it enters the endoplasmic reticulum during synthesis on membrane-bound polyribosomes. This is thus a cotranslational modification. In many of the *N*-linked glycoproteins there is a consensus sequence of Asn-X-Ser/Thr (where X = any amino acid other than proline) to determine the site of glycosylation; in others there is no clear consensus sequence for glycosylation.

As shown in Figure 46-4, the first step is a reaction between UDP-*N*-acetylglucosamine and dolichol phosphate, forming *N*-acetylglucosamine-dolichol pyrophosphate. A second *N*-acetylglucosamine is added from UDP-*N*-acetylglucosamine, followed by the addition of five molecules of mannose from GDP-mannose. The dolichol pyrophosphate oligosaccharide is then translocated into the lumen of the endoplasmic reticulum, and further mannose and glucose molecules are added, to form the final dolichol pyrophosphate oligosaccharide, using dolichol-phosphate mannose and dolichol phosphate-glucose as the donors. The dolichol

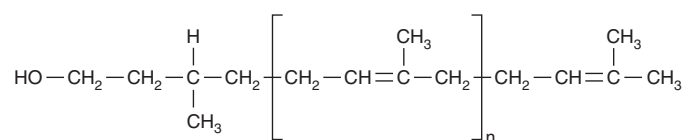

FIGURE 46-3 The structure of dolichol phosphate. The group within the brackets is an isoprene unit ($n = 17$ -20 isoprenoid units).

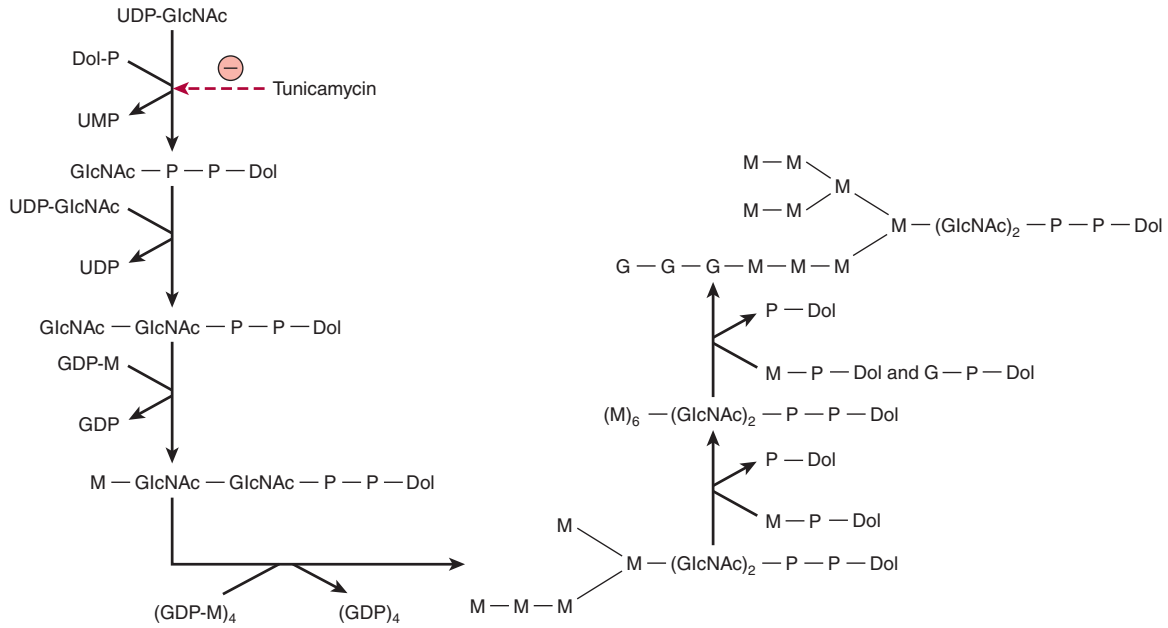

FIGURE 46-4 Pathway of biosynthesis of dolichol pyrophosphate oligosaccharide. Note that the first five internal mannose residues are donated by GDP-mannose, whereas the more external mannose residues and the glucose residues are donated by dolichol-P-mannose and dolichol-P-glucose. (UDP, uridine diphosphate; Dol, dolichol; P, phosphate; UMP, uridine monophosphate; GDP, guanosine diphosphate.)

pyrophosphate oligosaccharide is then transferred onto the acceptor asparagine residue of the nascent protein chain. The main features of *N*-glycosylation are listed in **Table 46-9**.

To form **high-mannose** chains, the glucose and some of the peripheral mannose residues are removed by glycosidases. To form an oligosaccharide chain of the **complex type**, the glucose residues and four of the mannose residues are removed by glycosidases in the endoplasmic reticulum and Golgi, then *N*-acetylglucosamine, galactose, and *N*-acetylneuraminic acid are added in reactions catalyzed by glycosyltransferases in the Golgi apparatus. **Hybrid chains**

TABLE 46-9 Summary of Main Features of *N*-Glycosylation

<ul style="list-style-type: none"> • The oligosaccharide $\text{Glc}_3\text{Man}_9(\text{GlcNAc})_2$ is transferred from dolichol-P-P-oligosaccharide in a reaction catalyzed by oligosaccharide:protein transferase, which is inhibited by tunicamycin.
<ul style="list-style-type: none"> • Transfer occurs to specific Asn residues in the sequence AsnX-Ser/Thr, where X is any residue except Pro, Asp, or Glu.
<ul style="list-style-type: none"> • Transfer can occur cotranslationally in the endoplasmic reticulum.
<ul style="list-style-type: none"> • The protein-bound oligosaccharide is then partially processed by glucosidases and mannosidases; if no additional sugars are added, this results in a high-mannose chain.
<ul style="list-style-type: none"> • If processing occurs down to the core heptasaccharide ($\text{Man}_5[\text{GlcNAc}]_2$), complex chains are synthesized by the addition of GlcNAc, removal of two Man, and the stepwise addition of individual sugars in reactions catalyzed by specific transferases (eg, GlcNAc, Gal, NeuAc transferases) that employ appropriate nucleotide sugars.

are formed by partial processing, forming complex chains on one arm and mannose units on the other arm.

Glycoproteins & Calnexin Ensure Correct Folding of Proteins in the Endoplasmic Reticulum

Calnexin is a chaperone protein in the endoplasmic reticulum membrane; binding to calnexin prevents a glycoprotein from aggregating. It is a lectin, recognizing specific carbohydrate sequences in the glycan chain of the glycoprotein. Incorrectly folded glycoproteins undergo partial deglycosylation, and are targeted to undergo transport from the endoplasmic reticulum back to the cytosol for catabolism.

Calnexin binds to glycoproteins that possess a monoglycosylated core structure from which the terminal glucose residue has been removed, leaving only the innermost glucose attached. Calnexin and the bound glycoprotein form a complex with **ERp57**, a homolog of protein disulfide isomerase, which catalyzes disulfide bond interchange, facilitating proper folding. The bound glycoprotein is released from its complex with calnexin-ERp57 when the sole remaining glucose is hydrolyzed by a glucosidase and is then available for secretion if it is properly folded. If it is not properly folded, a **glucosyltransferase** recognizes this and reglucosylates the glycoprotein, which rebinds to the calnexin-ERp57 complex. If it is now properly folded, the glycoprotein is again deglycosylated and secreted. If it is not capable of proper folding, it is translocated out of the endoplasmic reticulum into the cytosol for catabolism. The glucosyltransferase senses the folding of

the glycoprotein and only reglucosylates misfolded proteins. The soluble endoplasmic reticulum protein **calreticulin** performs a similar function to that of calnexin.

Several Factors Regulate the Glycosylation of Glycoproteins

The glycosylation of glycoproteins is a complex process involving a large number of enzymes; about 1% of the human genome codes for genes that are involved with protein glycosylation. There are at least ten distinct GlcNAc transferases. Multiple species of the other glycosyltransferases (eg, sialyltransferases) also exist. Controlling factors in the first stage of *N*-linked glycoprotein biosynthesis (assembly and transfer of the dolichol pyrophosphate oligosaccharide) include not only the availability of the sugar nucleotides, but also the presence of suitable acceptor sites in proteins, the tissue concentration of dolichol phosphate, and the activity of the oligosaccharide: protein transferase.

Some factors known to be involved in the regulation of **oligosaccharide processing** are listed in **Table 46–10**. **Species variations** among processing enzymes are important in relation to the production of glycoproteins of therapeutic use by means of recombinant DNA technology. For instance, **recombinant erythropoietin** (EPO) is administered to patients with some types of chronic anemia in order to stimulate erythropoiesis. The half-life of erythropoietin in plasma is influenced by its glycosylation pattern; some patterns are associated with a short half-life, limiting its therapeutic effectiveness. It is thus

TABLE 46–10 Some Factors Affecting the Activities of Glycoprotein Processing Enzymes

Factor	Comment
Cell type	Different cell types contain different profiles of processing enzymes.
Previous enzyme	Certain glycosyltransferases act only on an oligosaccharide chain if it has already been acted upon by another processing enzyme. ^a
Development	The cellular profile of processing enzymes may change during development if their genes are turned on or off.
Intracellular location	For instance, if an enzyme is destined for insertion into the membrane of the ER (eg, HMG-CoA reductase), it may never encounter Golgi-located processing enzymes.
Protein conformation	Differences in conformation of different proteins may facilitate or hinder access of processing enzymes to identical oligosaccharide chains.
Species	Same cells (eg, fibroblasts) from different species may exhibit different patterns of processing enzymes.
Cancer	Cancer cells may exhibit processing enzymes different from those of corresponding normal cells.

^aFor example, prior action of GlcNAc transferase I is necessary for the action of Golgi α -mannosidase II.

important to harvest EPO from host cells that confer a pattern of glycosylation consistent with a normal half-life in plasma.

There is also great interest in analysis of the activities of glycoprotein-processing enzymes in various types of **cancer cells**. These cells have often been found to synthesize different oligosaccharide chains from those made in normal cells (eg, they often exhibit greater branching). This could be due to cancer cells expressing different patterns of glycosyltransferases from those in normal cells, as a result of specific gene activation or repression. The differences in oligosaccharide chains could affect adhesive interactions between cancer cells and their normal parent tissue cells, contributing to metastasis.

SOME PROTEINS ARE ANCHORED TO THE PLASMA MEMBRANE BY GLYCOPHOSPHATIDYL-INOSITOL STRUCTURES

The third major class of glycoproteins is the membrane-bound proteins that are anchored to the lipid bilayer by a glycoposphatidylinositol (GPI) tail (Figure 46–1). GPI linkage is the commonest way in which various proteins are anchored to cell membranes.

The proteins are anchored to the outer leaflet of the plasma membrane or the inner (luminal) leaflet of the membrane in secretory vesicles by the fatty acids of phosphatidylinositol. The phosphatidylinositol is linked via *N*-acetyl glucosamine to a glycan chain containing a variety of sugars, including mannose and glucosamine. In turn, the oligosaccharide chain is linked via phosphorylethanolamine in an amide linkage to the carboxyl terminal amino acid of the attached protein. Additional constituents are found in many GPI structures; for example, that shown in Figure 46–1 contains an extra phosphorylethanolamine attached to the middle of the three mannose moieties of the glycan and an extra fatty acid attached to glucosamine. Examples of some proteins that are anchored by GPI-linkage are given in **Table 46–11**.

There are three possible functions of this GPI-linkage:

1. The GPI anchor allows greatly enhanced **mobility** of a protein in the plasma membrane compared with that for a protein that contains transmembrane sequences. The GPI anchor is attached only to the outer leaflet of the lipid bilayer, so that it is freer to diffuse than a protein anchored

TABLE 46–11 Some GPI-Linked Proteins

• Acetylcholinesterase (red cell membrane)
• Alkaline phosphatase (intestinal, placental)
• Decay-accelerating factor (red cell membrane)
• 5'-Nucleotidase (T lymphocytes, other cells)
• Thy-1 antigen (brain, T lymphocytes)
• Variable surface glycoprotein (<i>Trypanosoma brucei</i>)

through both layers of the membrane. Increased mobility may be important in facilitating rapid responses to stimuli.

- Some GPI anchors may connect with **signal transduction** pathways, so that proteins that do not have a transmembrane domain may nevertheless be receptors for hormones and other cell-surface signals.
- GPI structures can **target** proteins to apical or basolateral domains of the plasma membrane of polarized epithelial cells.

The GPI anchor is preformed in the endoplasmic reticulum, and is then attached to the protein after ribosomal synthesis is complete. The primary translation products of GPI-anchored proteins have not only an amino terminal signal sequence that directs them into the endoplasmic reticulum during synthesis, but also a carboxy terminal hydrophobic domain that acts as the signal for attachment of the GPI anchor. The first stage in synthesis of the GPI anchor is insertion of the fatty acids of phosphatidylinositol into the luminal face of the endoplasmic reticulum membrane, followed by glycosylation, starting with esterification of *N*-acetylglucosamine to the phosphate group of phosphatidylinositol. A terminal phosphoethanolamine moiety is added to the completed glycan chain. The hydrophobic carboxy terminal domain of the protein is displaced by the amino group of ethanolamine in the transamidation reaction that forms the amide linkage between the GPI anchor and an aspartate residue in the protein.

SOME PROTEINS UNDERGO RAPIDLY REVERSIBLE GLYCOSYLATION

Many proteins, including nuclear pore proteins, proteins of the cytoskeleton, transcription factors and proteins associated with chromatin, as well as nuclear oncogene proteins and tumor suppressor proteins, undergo *O*-glycosylation with a single sugar moiety, *N*-acetylglucosamine. This is a rapidly reversible glycosylation. The serine and threonine sites of glycosylation are the same as those of phosphorylation of these proteins, and glycosylation and phosphorylation occur reciprocally in response to cellular signaling.

The *O*-linked *N*-acetylglucosamine transferase that catalyzes this glycosylation uses UDP-*N*-acetylglucosamine as the sugar donor, and has phosphatase activity, so can directly replace a serine or threonine phosphate with *N*-acetylglucosamine. There is no absolute consensus sequence for the reaction, but about half the sites that are subject to reciprocal glycosylation and phosphorylation are Pro-Val-Ser. The enzyme is activated by phosphorylation in response to insulin action, and the *N*-acetylglucosamine is removed (leaving the site available for phosphorylation) by *N*-acetylglucosaminidase.

Both the activity and peptide specificity of *O*-linked *N*-acetylglucosamine transferase depend on the concentration of UDP-*N*-acetylglucosamine. Depending on cell type, up to 2% to 5% of glucose metabolism is by way of the hexosamine pathway

leading to *N*-acetylglucosamine formation, giving the *O*-linked *N*-acetylglucosamine transferase a role in nutrient sensing in the cell. Excessive *O*-glycosylation with *N*-acetylglucosamine (and hence reduced phosphorylation) of target proteins is implicated in **insulin resistance** and glucose toxicity in **diabetes mellitus**, as well as neurodegenerative diseases.

ADVANCED GLYCATION END-PRODUCTS (AGEs) ARE IMPORTANT IN CAUSING TISSUE DAMAGE IN DIABETES MELLITUS

Glycation is the nonenzymic attachment of sugars (mainly glucose) to amino groups of proteins (and also to other molecules including DNA and lipids). Glycation is distinguished from **glycosylation** which is the enzyme-catalyzed attachment of sugars. Initially, glucose forms a **Schiff base** to the amino group protein, which then undergoes the **Amadori rearrangement** to yield **ketoamines** (see Figure 46–5), and further reactions to yield **advanced glycation end-products (AGEs)**. The overall series of reactions is known as the **Maillard reaction**, which is involved in the **browning** of certain foodstuffs during storage or heating, and provides much of the flavor of some foods.

Advanced glycation end-products underlie **tissue damage** in poorly controlled **diabetes mellitus**. When the blood glucose concentration is consistently elevated, there is increased glycation of proteins. Glycation of collagen and other proteins in the extracellular matrix alters their properties (eg, increasing the **cross-linking of collagen**). Cross-linking can lead to accumulation of various plasma proteins in the walls of blood vessels; in particular, accumulation of **LDL** can contribute to **atherogenesis**. AGEs appear to be involved in both **microvascular** and **macrovascular** damage in diabetes mellitus (Figure 46–6). Endothelial cells and macrophages have AGE receptors on their surfaces. Uptake of glycated proteins by these receptors can

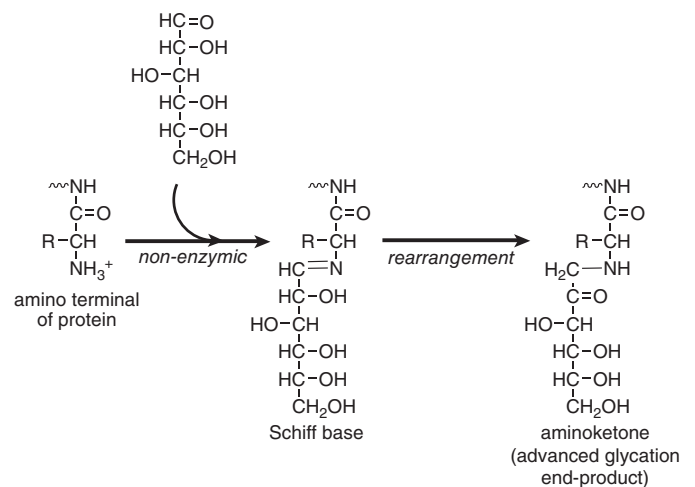

FIGURE 46–5 Formation of advanced glycation end-products from glucose.

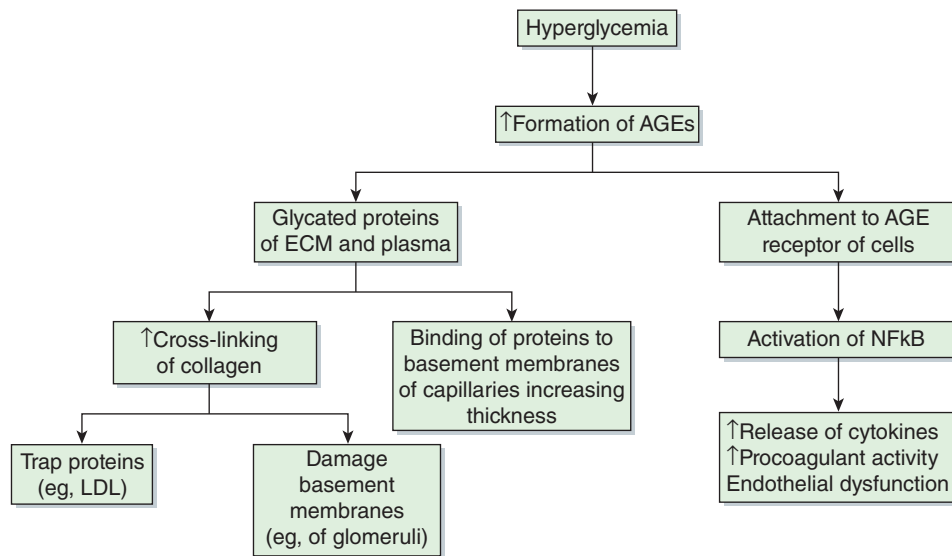

FIGURE 46–6 Some consequences of the formation of advanced glycation end-products.

activate the transcription factor **NF-κB** (see Chapter 52), generating a variety of **cytokines** and **proinflammatory molecules**. It is thus believed that AGEs are a significant contributor to some of the pathology of diabetes.

Nonenzymic attachment glycation of **hemoglobin A** present in red blood cells leads to the formation of **HbA_{1c}**. It occurs normally to a modest extent, and is increased in patients with diabetes mellitus with poor glycemic control, whose blood glucose concentration is consistently elevated. As discussed in Chapter 6, measurement of HbA_{1c} has become a very important part of the **management of patients with diabetes mellitus**.

GLYCOPROTEINS ARE INVOLVED IN MANY BIOLOGIC PROCESSES & IN MANY DISEASES

As listed in Table 46–1, glycoproteins have many different functions; some have already been addressed in this chapter and others are described elsewhere in this text (eg, transport molecules, immunological molecules, and hormones). They are also important in fertilization and inflammation, and a number of diseases are due to defects in the synthesis and catabolism of glycoproteins.

Glycoproteins Are Important in Fertilization

To reach the plasma membrane of an oocyte, a sperm has to traverse the **zona pellucida (ZP)**, a thick, transparent, non-cellular envelope that surrounds the oocyte. The glycoprotein ZP3 is an *O*-linked glycoprotein that functions as a sperm receptor. A protein on the sperm surface interacts with the oligosaccharide chains of ZP3. By transmembrane signaling, this interaction induces the **acrosomal reaction**, in which

enzymes such as proteases and hyaluronidase and other contents of the acrosome of the sperm are released. Liberation of these enzymes permits the sperm to pass through the zona pellucida and reach the plasma membrane of the oocyte. Another glycoprotein, PH-30, is important in both the binding of the plasma membrane of the sperm to that of the oocyte, and also in the subsequent fusion of the two membranes. These interactions enable the sperm to enter and fertilize the oocyte. It may be possible to **inhibit fertilization** by developing drugs that interfere with the normal functions of ZP3 and PH-30, which would thus act as contraceptive agents.

Selectins Play Key Roles in Inflammation & in Lymphocyte Homing

Leukocytes play important roles in many inflammatory and immunological phenomena. The first steps in many of these phenomena are interactions between circulating leukocytes and **endothelial cells** prior to passage of the former out of the circulation. Leukocytes and endothelial cells contain cell surface lectins, called **selectins**, which participate in intercellular adhesion. Selectins are single-chain Ca^{2+} -binding transmembrane proteins; the amino terminals contain the lectin domain, which is involved in binding to specific carbohydrate ligands.

Interactions between selectins on the neutrophil cell surface and glycoproteins on the endothelial cell trap the neutrophils temporarily, so that they roll over the endothelial surface. During this the neutrophils are activated, undergo a change in shape and now adhere firmly to the endothelium. This adhesion is the result of interactions between **integrins** (see Chapter 53) on the neutrophils and immunoglobulin-related proteins on the endothelial cells. After adhesion, the neutrophils insert pseudopodia into the junctions between endothelial cells, squeeze through these junctions, cross the basement membrane, and are then free to migrate in the extravascular space.

Selectins bind **sialylated and fucosylated oligosaccharides**. Sulfated lipids (see Chapter 21) may also be ligands. Synthesis of compounds such as monoclonal antibodies that block selectin-ligand interactions may be therapeutically useful to inhibit inflammatory responses. **Cancer cells** often have selectin ligands on their surfaces, which may have a role in the invasion and metastasis of cancer cells.

Abnormalities in the Synthesis of Glycoproteins Underlie Certain Diseases

Table 46–12 lists a number of conditions in which abnormalities in the synthesis of glycoproteins is important. As mentioned above, many **cancer cells** exhibit different profiles of oligosaccharide chains on their surfaces, some of which may contribute to metastasis.

The major features of the **congenital disorders of glycosylation** are summarized in **Table 46–13**.

Leukocyte adhesion deficiency II is a rare condition probably due to mutations affecting the activity of a Golgi-located GDP-fucose transporter. The absence of fucosylated ligands for selectins leads to a marked decrease in neutrophil rolling. Subjects suffer life-threatening, recurrent bacterial infections, and also psychomotor and mental retardation. The condition appears to respond to oral fucose.

Paroxysmal nocturnal hemoglobinuria is an acquired mild anemia characterized by the presence of hemoglobin in

TABLE 46–12 Some Diseases Involving Abnormalities in the Biosynthesis of Glycoproteins

Disease	Abnormality
Cancer	Increased branching of cell surface glycans or presentation of selectin ligands may be important in metastasis.
Congenital disorders of glycosylation ^a	See Table 46–13.
HEMPAS ^b (OMIM 224100)	Abnormalities in certain enzymes (eg, mannosidase II and others) involved in the biosynthesis of <i>N</i> -glycans, particularly affecting the red blood cell membrane.
Leukocyte adhesion deficiency, type II (OMIM 266265)	Probably mutations affecting a Golgi-located GDP-fucose transporter, resulting in defective fucosylation.
Paroxysmal nocturnal hemoglobinuria (PNH) (OMIM 311770)	Acquired defect in biosynthesis of the GPI ^c structures of decay accelerating factor (DAF) and CD59.
I-cell disease (OMIM 252500)	Deficiency of GlcNAc phosphotransferase, resulting in abnormal targeting of certain lysosomal enzymes.

^aThe OMIM number for congenital disorder of glycosylation type Ia is 212065.

^bHereditary erythroblastic multinuclearity with a positive acidified serum lysis test (congenital dyserythropoietic anemia type II). This is a relatively mild form of anemia. It reflects at least in part the presence in the red cell membranes of various glycoproteins with abnormal *N*-glycan chains, which contribute to the susceptibility to lysis.

^cGlycosylphosphatidylinositol.

TABLE 46–13 Major Features of the Congenital Disorders of Glycosylation

- Autosomal recessive disorders.
- Multisystem disorders that have probably not been recognized in the past.
- Generally affect the central nervous system, resulting in psychomotor retardation and other features.
- Type I disorders are due to mutations in genes encoding enzymes (eg, phosphomannomutase-2 [PMM-2], causing CDG Ia) involved in the synthesis of dolichol-P-P-oligosaccharide.
- Type II disorders are due to mutations in genes encoding enzymes (eg, GlcNAc transferase-2, causing CDG IIa) involved in the processing of *N*-glycan chains.
- At least 15 distinct disorders have been recognized.
- Isoelectric focusing of transferrin is a useful biochemical test for assisting in the diagnosis of these conditions; truncation of the oligosaccharide chains of this protein alters its isoelectric focusing pattern.
- Oral mannose has proved of benefit in the treatment of CDG Ia.

Abbreviation: CDG, congenital disorder of glycosylation.

urine due to hemolysis of red cells, particularly during sleep, which may reflect a slight drop in plasma pH during sleep, which increases susceptibility to lysis by the complement system (see Chapter 52). The condition is due to the acquisition in hematopoietic cells of somatic mutations in the gene coding for the enzyme that links glucosamine to phosphatidylinositol in the GPI structure. This leads to a deficiency of proteins that are anchored to the red cell membrane by GPI-linkage. Two proteins, **decay accelerating factor** and **CD59** normally interact with components of the complement system to prevent the hemolysis. When they are deficient, the complement system acts on the red cell membrane to cause hemolysis.

Some of the **congenital muscular dystrophies (CMDs)** are the result of defects in the synthesis of glycans in the protein α -dystroglycan. This protein protrudes from the surface membrane of muscle cells and interacts with laminin-2 (merosin) in the basal lamina. If the glycans of α -dystroglycan are not correctly formed (as a result of mutations in genes encoding some glycosyltransferases), this results in defective interaction of α -DG with laminin.

Rheumatoid arthritis is associated with an alteration in the glycosylation of circulating immunoglobulin G (IgG) molecules (see Chapter 52), such that they lack galactose in their Fc regions and terminate in GlcNAc. **Mannose-binding protein**, a lectin synthesized by liver cells and secreted into the circulation, binds mannose, *N*-acetylglucosamine, and some other sugars. It can thus bind agalactosyl IgG molecules, which subsequently activate the complement system, contributing to chronic inflammation in the synovial membranes of joints.

Mannose-binding protein can also bind sugars when they are present on the surfaces of bacteria, fungi, and viruses, preparing these pathogens for opsonization or for destruction by the complement system. This is an example of **innate immunity**, not involving immunoglobulins or T lymphocytes.

TABLE 46-14 Major Features of Some Diseases^a due to Deficiencies of Glycoprotein Hydrolases^b

• Usually exhibit mental retardation or other neurologic abnormalities, and in some disorders coarse features or visceromegaly (or both).
• Variations in severity from mild to rapidly progressive.
• Autosomal recessive inheritance.
• May show ethnic distribution (eg, aspartylglycosaminuria is common in Finland).
• Vacuolization of cells observed by microscopy in some disorders.
• Presence of abnormal degradation products (eg, oligosaccharides that accumulate because of the enzyme deficiency) in urine, detectable by TLC and characterizable by GLC-MS.
• Definitive diagnosis made by assay of appropriate enzyme, often using leukocytes.
• Possibility of prenatal diagnosis by appropriate enzyme assays.
• No definitive treatment at present.

^a α -Mannosidosis, β -mannosidosis, fucosidosis, sialidosis, aspartylglycosaminuria, and Schindler disease.^bOMIM numbers: α -mannosidosis, 248500; β -mannosidosis, 248510; fucosidosis, 230000; sialidosis, 256550; aspartylglycosaminuria, 208400; Schindler disease, 609241.

Deficiency of this protein in young infants as a result of mutation renders them susceptible to **recurrent infections**.

Inclusion Cell (I-Cell) Disease Results from Faulty Targeting of Lysosomal Enzymes

Mannose 6-phosphate serves to target enzymes into the lysosome. I-cell disease is an uncommon condition characterized by severe progressive psychomotor retardation and a variety of physical signs, with death often occurring in the first decade of life. Cells from patients with I-cell disease lack almost all of the normal lysosomal enzymes; the lysosomes thus accumulate many different types of undegraded molecules, forming inclusion bodies. The patients' plasma contains very high activities of lysosomal enzymes, suggesting that the enzymes are synthesized but fail to reach their proper intracellular destination and are instead secreted. Cultured cells from patients take up exogenously added lysosomal enzymes obtained from normal subjects, indicating that the cells have a normal receptor on their surfaces for endocytic uptake of lysosomal enzymes. Lysosomal enzymes from normal individuals carry the mannose 6-phosphate recognition marker, cells from patients with I-cell disease lack the Golgi-located *N*-acetylglucosamine phosphotransferase. Two lectins act as **mannose 6-phosphate receptor proteins**. Both function in the intracellular sorting of lysosomal enzymes into clathrin-coated vesicles in the Golgi. These vesicles then leave the Golgi and fuse with a prelysosomal compartment.

Genetic Deficiencies of Glycoprotein Lysosomal Hydrolases Cause Diseases Such as α -Mannosidosis

Turnover of glycoproteins involves catabolism of the oligosaccharide chains catalyzed by a number of lysosomal hydrolases,

including α -neuraminidase, β -galactosidase, β -hexosaminidase, α - and β -mannosidases, α -*N*-acetylgalactosaminidase, α -fucosidase, endo- β -*N*-acetylglucosaminidase, and aspartylglucosaminidase. Genetic defects of these enzymes result in abnormal degradation of glycoproteins. The accumulation in tissues of partially degraded glycoproteins leads to various diseases. Among the best recognized of these are mannosidosis, fucosidosis, sialidosis, aspartylglycosaminuria, and Schindler disease, due respectively to deficiencies of α -mannosidase, α -fucosidase, α -neuraminidase, aspartylglucosaminidase, and α -*N*-acetylgalactosaminidase. Some of the major features of these diseases are listed in **Table 46-14**.

GLYCANS ARE INVOLVED IN THE BINDING OF VIRUSES, BACTERIA, & SOME PARASITES TO HUMAN CELLS

A feature of glycans that explains many of their biological actions, is that they bind specifically to proteins and other glycans. One reflection of this is their ability to bind some viruses, bacteria, and parasites.

Influenza virus A binds to cell surface glycoprotein receptor molecules containing *N*-acetylneuraminic acid via a **hemagglutinin** protein. The virus also has a **neuraminidase** that plays a key role in allowing elution of newly synthesized progeny from infected cells. If this process is inhibited, spread of the viruses is markedly diminished. Inhibitors of this enzyme (eg, zanamivir, oseltamivir) are now available for use in treating patients with influenza. Influenza viruses are classified according to the type of hemagglutinin (H) and neuraminidase (N) that they possess. There are at least 16 types of hemagglutinin and nine types of neuraminidase. Thus, **avian influenza virus** is classified as **H5N1**.

Human immunodeficiency virus type 1 (HIV-1), the cause of AIDS, attaches to cells via one of its surface glycoproteins (gp 120) and uses another surface glycoprotein (gp 41) to fuse with the host cell membrane. **Antibodies** to gp 120 develop during infection by HIV-1, and there has been interest in using the protein as a vaccine. One major problem with this approach is that the structure of gp 120 can change relatively rapidly due to mutations, allowing the virus to escape from the neutralizing activity of antibodies directed against it.

Helicobacter pylori is the major cause of **peptic ulcers**. It binds to at least two different glycans present on the surfaces of epithelial cells in the stomach allowing it to establish a stable attachment site to the stomach lining. Similarly, many bacteria that cause **diarrhea** attach to surface cells of the intestinal mucosa via glycans present in glycoproteins or glycolipids. The attachment of the malarial parasite *Plasmodium falciparum* to human cells is mediated by a GPI present on the surface of the parasite.

SUMMARY

- Glycoproteins are widely distributed proteins with diverse functions that contain one or more covalently linked carbohydrate chains.
- The carbohydrate content of a glycoprotein ranges from 1% to more than 85% of its weight and may be simple or very complex in the structure. Eight sugars are mainly found in the sugar chains of human glycoproteins: xylose, fucose, galactose, glucose, mannose, *N*-acetylgalactosamine, *N*-acetylglucosamine and *N*-acetylneuraminic acid.
- At least some of the oligosaccharide chains of glycoproteins encode biological information; they are also important in modulating the solubility and viscosity of glycoproteins, in protecting them against proteolysis, and in their biological actions.
- Glycosidases hydrolyze specific linkages in oligosaccharides and are used to explore the structures and functions of glycoproteins.
- Lectins are carbohydrate-binding proteins involved in cell adhesion and many other processes.
- The major classes of glycoproteins are *O*-linked (involving serine or threonine), *N*-linked (involving the amide group of asparagine), and GPI-linked.
- Mucins are a class of *O*-linked glycoproteins that are distributed on the surfaces of epithelial cells of the respiratory, gastrointestinal, and reproductive tracts.
- The endoplasmic reticulum and Golgi apparatus play a major role in glycosylation reactions involved in the biosynthesis of glycoproteins.
- The oligosaccharide chains of *O*-linked glycoproteins are synthesized by the stepwise addition of sugars donated by sugar nucleotides in reactions catalyzed by glycoprotein glycosyltransferases.
- The synthesis of *N*-linked glycoproteins involves a specific dolichol-P-P-oligosaccharide and various glycotransferases and glycosidases. Depending on the enzymes and precursor proteins in a tissue, it can synthesize complex, hybrid, or high-mannose types of *N*-linked oligosaccharides.
- Glycoproteins are implicated in many biological processes, including fertilization and inflammation.

- There are a number of diseases involving abnormalities in the synthesis and degradation of glycoproteins. Glycoproteins are also involved in many other diseases, including influenza, AIDS, rheumatoid arthritis, cystic fibrosis and peptic ulcer.

REFERENCES

- Chandrasekaran A, Srinivasan A, Raman R, et al: Glycan topology determines human adaptation of avian H5N1 virus hemagglutinin. *Nat Biotechnology* 2008;26:107.
- Freeze HH: Congenital disorders of glycosylation: CDG-I, CDG-II, and beyond. *Curr Mol Med* 2007;7:389.
- Haltiwanger RS, Lowe JB: Role of glycosylation in development. *Annu Rev Biochem* 2004;73:491–537.
- Hart GW, Slawson C, Ramirez-Correa G, Lagerlof O. Cross-talk between *O*-Glc *N*-acylation and phosphorylation: roles in signaling, transcription and chronic disease. *Annu Rev Biochem* 2011;80:825–858.
- Kiessling LL, Splain RA: Chemical approaches to glycobiology. *Annu Rev Biochem*. 2010;79:619.
- Kornfeld R, Kornfeld S: Assembly of asparagine-linked oligosaccharides. *Annu Rev Biochem* 1985;54:631.
- Lowe JB, Marth JB: A genetic approach to mammalian glycan function. *Annu Rev Biochem* 2003;72:643–691.
- Ohtsubo K, Marth JD: Glycosylation in cellular mechanisms of health and disease. *Cell* 2006;126:855.
- Pilobelli KT, Mahal LK: Deciphering the glycode: the complexity and analytical challenge of glycomics. *Curr Opin Chem Biol* 2007;11:300.
- Sansom C, Markman O: *Glycobiology*. Scion Publishing, 2007.
- Spiro RG: Protein glycosylation: nature, distribution, enzymatic formation, and disease implications of glycopeptide bonds. *Glycobiology* 2002;12:43R–53R.
- Taylor ME, Drickamer K: *Introduction to Glycobiology*. 3rd edition, Oxford University Press, 2011.
- Udenfriend S, Kodukula K: How glycosylphosphatidyl anchored membrane proteins are made. *Annu Rev Biochem* 1995;64: 563–591.
- Varki A, Cummings RD, Esko JD, et al: *Essentials of Glycobiology*. 2nd ed. Cold Spring Harbor Laboratory Press, 2008.
- Werz DB, Seeberger PH: Carbohydrates are the next frontier in pharmaceutical research. *Chemistry* 2005;11:3194.

Metabolism of Xenobiotics

David A. Bender, PhD & Robert K. Murray, MD, PhD

OBJECTIVES

After studying this chapter, you should be able to:

- Discuss how drugs and other xenobiotics are metabolized in the body.
- Describe the two general phases of xenobiotic metabolism, the first involving mainly hydroxylation reactions catalyzed by cytochrome P450 species and the second conjugation reactions catalyzed by various enzymes.
- Describe the metabolic importance of glutathione.
- Appreciate that xenobiotics can cause pharmacologic, toxic, immunologic, and carcinogenic effects.

BIOMEDICAL IMPORTANCE

We are exposed to a wide variety of foreign chemicals (**xenobiotics**), both naturally occurring compounds in plant foods, and synthetic compounds in medicines, food additives, and environmental pollutants. Knowledge of the metabolism of xenobiotics is essential for an understanding of pharmacology and therapeutics, toxicology, and the management of disease. All these areas involve either the administration of, or exposure to, xenobiotics. Many of the xenobiotics in plant foods have potentially beneficial effects (eg, acting as antioxidants, Chapter 45), and knowledge of their metabolism will permit extrapolation from *in vitro* measurement of antioxidant activity to *in vivo* protective action.

Understanding the mechanisms involved in xenobiotic metabolism will permit the development of transgenic microorganisms and plants containing genes that encode enzymes for the metabolism of specific compounds that can be used to convert potentially hazardous pollutants to harmless compounds. Similarly, transgenic organisms may be used for biosynthesis of drugs and other chemicals.

WE ENCOUNTER MANY XENOBIOTICS THAT MUST BE METABOLIZED BEFORE BEING EXCRETED

A **xenobiotic** (Gk *xenos* “stranger”) is a compound that is foreign to the body. The principal classes of xenobiotics of medical relevance are **drugs**, **chemical carcinogens**, naturally

occurring compounds in plant foods, and various compounds that have found their way into our environment by one route or another, such as polychlorinated biphenyls (PCBs), insecticides and other pesticides. More than 200,000 manufactured environmental chemicals exist. Most of these compounds are subject to metabolism, mainly in the liver. While the metabolism of xenobiotics is generally considered to be a process of detoxification, sometimes the metabolites of compounds that are themselves inert or harmless are biologically active. This may be desirable, as in the activation of a prodrug to the active compound, or it may be undesirable, as in the formation of a carcinogen or mutagen from an inert precursor.

The metabolism of xenobiotics is generally considered in two phases. In **phase 1**, the major reaction involved is **hydroxylation**, catalyzed mainly by members of a class of enzymes referred to as **monooxygenases** or **cytochromes P450**. Hydroxylation may terminate the action of a drug, though this is not always the case. In addition to hydroxylation, these enzymes catalyze a wide range of reactions, including those involving deamination, dehalogenation, desulfuration, epoxidation, peroxygenation, and reduction. Reactions involving hydrolysis (eg, catalyzed by esterases) and certain other non-P450-catalyzed reactions also occur in phase 1.

Phase 1 metabolism renders compounds more reactive, introducing groups that can be conjugated with glucuronic acid, sulfate, acetate, glutathione, or amino acids in phase 2 metabolism. This produces **polar compounds** that are water-soluble and can therefore readily be excreted in urine or bile. Very hydrophobic xenobiotics would persist in adipose tissue almost indefinitely if they were not converted to more polar forms.

In some cases, phase 1 metabolic reactions convert xenobiotics from **inactive** to **biologically active** compounds. In these instances, the original xenobiotics are referred to as **prodrugs** or **procarcinogens**. Sometimes, additional phase 1 reactions (eg, further hydroxylation reactions) convert these active compounds into less active or inactive forms prior to conjugation. In yet other cases, it is the conjugation reactions themselves that convert the active products of phase 1 reactions to less active or inactive compounds, which are excreted. In a very few cases, conjugation may increase the biological activity of a xenobiotic.

ISOFORMS OF CYTOCHROME P450 HYDROXYLATE A MYRIAD OF XENOBIOTICS IN PHASE 1 OF THEIR METABOLISM

The main reaction involved in phase 1 metabolism is **hydroxylation**, catalyzed by a family of enzymes known as **monooxygenases** or **cytochromes P450**. There are at least 57 cytochrome P450 genes in the human genome.

Cytochrome P450 is a heme enzyme. It is so named because it was originally discovered when it was noted that preparations of microsomes (fragments of the endoplasmic reticulum) that had been chemically reduced and then exposed to carbon monoxide exhibited an absorption peak at 450 nm. Approximately 50% of the common drugs that humans ingest are metabolized by isoforms of cytochrome P450. They also act on steroid hormones, carcinogens, and pollutants. The major cytochromes P450 in drug metabolism are members of the CYP1, CYP2, and CYP3 families (see below). In addition to their role in metabolism of xenobiotics, cytochromes P450 are important in the metabolism of a number of physiological compounds—for example, the synthesis of steroid hormones (see Chapter 26) and the conversion of vitamin D to its active metabolite, calcitriol (see Chapter 44).

The overall reaction catalyzed by a cytochrome P450 is:

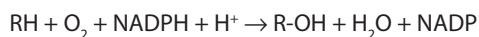

The role of NADPH is to reduce cytochrome P450; the reduced cytochrome then reduces oxygen to water and the hydroxyl group that is introduced into the substrate. The reaction mechanism is complex (see Figure 12–6). Using $^{18}\text{O}_2$ it has been shown that one atom of oxygen forms the hydroxyl group of R–OH and the other forms water. This dual fate of the oxygen accounts for the former naming of monooxygenases as “**mixed-function oxidases**.”

Isoforms of Cytochrome P450 Make Up a Superfamily of Heme-Containing Enzymes

Because of the **large number of isoforms** of cytochrome P450 that have been discovered (about 150, in a wide range of organisms, including bacteria), it is important to have a

systematic nomenclature for the enzymes and their genes. It is based on amino acid sequence homology of the enzymes. The abbreviated root symbol CYP denotes a cytochrome P450. This is followed by an Arabic numeral designating the **family**; cytochromes P450 are included in the same family if they exhibit 40% or more amino acid sequence identity. The Arabic number is followed by a capital letter indicating the **subfamily**; P450s are in the same subfamily if they exhibit greater than 55% sequence identity. The **individual** P450s are then assigned Arabic numerals in their subfamily. Thus, CYP1A1 denotes a cytochrome P450 that is a member of family 1 and subfamily A and is the first individual member of that subfamily. The nomenclature for the **genes** encoding cytochrome P450s is the same, except that italics are used; thus, the gene encoding CYP1A1 is *CYP1A1*. The families of cytochrome P450 in human tissues, and their principal functions, are shown in Table 47–1.

In mammals, cytochromes P450 are present in highest amount in **liver cells** and enterocytes but are probably present in all tissues. In liver and most other tissues, they are present

TABLE 47–1 The Families of Cytochrome P450 in Human Tissues

Family	Function	Members
CYP1	Drug and steroid (especially estrogen) metabolism	3 subfamilies
CYP2	Drug and steroid metabolism	13 subfamilies
CYP3	Drug and steroid (including testosterone) metabolism	1 subfamily
CYP4	Arachidonic acid and fatty acid metabolism	6 subfamilies
CYP5	Thromboxane A ₂ synthase	1 subfamily
CYP7	Bile acid biosynthesis and steroid 7 α hydroxylase	2 subfamilies
CYP8	Various, including prostacyclin synthase and bile acid synthesis	2 subfamilies
CYP11	Steroid biosynthesis	2 subfamilies
CYP17	Steroid biosynthesis, 17 α hydroxylase	1 subfamily
CYP19	Steroid biosynthesis, aromatase	1 subfamily
CYP20	Unknown function	1 subfamily
CYP21	Steroid biosynthesis	2 subfamilies
CYP24	Vitamin D catabolism	1 subfamily
CYP26	Retinoic acid hydroxylase	3 subfamilies
CYP27	Various, including bile acid synthesis and calcitriol 1 α hydroxylase.	3 subfamilies
CYP39	7-Alpha hydroxylation of 24-hydroxycholesterol	1 subfamily
CYP46	Cholesterol 24-hydroxylase	1 subfamily
CYP51	Cholesterol biosynthesis	1 subfamily

mainly in the **membranes of the smooth endoplasmic reticulum**, which constitute part of the **microsomal fraction** when tissue is subjected to subcellular fractionation. In hepatic microsomes, cytochromes P450 can comprise as much as 20% of the total protein. P450s are found in most tissues, though often in low amounts compared with liver. In the **adrenal gland**, they are found in **mitochondria** as well as in the endoplasmic reticulum; the various hydroxylases present in the gland are involved in cholesterol and steroid hormone biosynthesis. The mitochondrial cytochrome P450 system differs from the microsomal system in that it uses an NADPH-linked flavoprotein, **adrenodoxin reductase**, and a nonheme iron-sulfur protein, **adrenodoxin**. In addition, the P450 isoforms involved in steroid biosynthesis are generally much more restricted in their substrate specificity.

Not only is there a wide variety of cytochromes P450, but they also have overlapping substrate specificities, so that a very broad range of xenobiotics can be metabolized by one or other of the cytochromes P450.

NADPH, not NADH, is involved in the reaction mechanism of cytochrome P450, in a reaction catalyzed by **NADPH-cytochrome P450 reductase**. Electrons are transferred from NADPH to NADPH-cytochrome P450 reductase and then to cytochrome P450. This leads to the **reductive activation of molecular oxygen**, and one atom of oxygen is subsequently inserted into the substrate. **Cytochrome b_5** , another hemoprotein found in the membranes of the smooth endoplasmic reticulum (see Chapter 12), may be involved as an electron donor in some cases.

Most isoforms of cytochrome P450 are **inducible**. For instance, the administration of phenobarbital or other drugs causes hypertrophy of the smooth endoplasmic reticulum and a three- to fourfold increase in the amount of cytochrome P450 within 4 to 5 days. In most cases this involves increased transcription of mRNA. However, in some cases, induction involves stabilization of mRNA or the enzyme protein itself, or an increase in the translation of mRNA.

Induction of cytochrome P450 underlies **drug interactions**, when the effects of one drug are altered by prior, concurrent, or later administration of another. For example, the anticoagulant **warfarin** is metabolized by **CYP2C9**, which is induced by phenobarbital. Induction of CYP2C9 by phenobarbital will increase the metabolism of warfarin, so reducing its efficacy, and the dose must be increased. Another example involves **CYP2E1**, which is induced by consumption of **ethanol**. This P450 metabolizes some widely used solvents and compounds found in tobacco smoke, many of which are established **procarcinogens**. If the activity of CYP2E1 induced by ethanol, this may increase the risk of carcinogenicity.

Naturally occurring compounds in foods may also affect cytochrome P450. Grapefruit contains a variety of furanocoumarins, which inhibit cytochrome P450 and so affect the metabolism of many drugs. Some drugs are activated by cytochrome P450, so that grapefruit will reduce their activity; others are inactivated by cytochrome P450, so that grapefruit increases their activity. Drugs that are affected

include statins, omeprazole, antihistamines and benzodiazepine antidepressants.

Polymorphism of cytochromes P450 may explain much of the variations in drug responses noted among many patients – variants with low catalytic activity will lead to slower metabolism of the substrate, and hence prolonged drug action and accumulation of the drug in the body. One interesting polymorphism is that of **CYP2A6**, which is involved in the metabolism of **nicotine** to conitine. Three CYP2A6 alleles have been identified: a wild type and two null or inactive alleles. It has been reported that individuals with the null alleles, who have impaired metabolism of nicotine, are apparently protected against becoming tobacco-dependent smokers. These individuals smoke less, presumably because their blood and brain concentrations of nicotine remain elevated longer than those of individuals with the wild-type allele. It has been speculated that inhibiting CYP2A6 may provide a novel way to help smoking cessation.

Table 47–2 summarizes some principal features of cytochromes P450.

TABLE 47–2 Some Properties of Human Cytochromes P450

<ul style="list-style-type: none"> Involved in phase I of the metabolism of a large number of xenobiotics, including perhaps 50% of the clinically used drugs; they may increase, decrease or not affect the activities of various drugs.
<ul style="list-style-type: none"> Involved in the metabolism of many endogenous compounds (eg, steroids).
<ul style="list-style-type: none"> All are hemoproteins.
<ul style="list-style-type: none"> Often exhibit broad substrate specificity, thus acting on many compounds; consequently, different P450s may catalyze formation of the same product.
<ul style="list-style-type: none"> Extremely versatile catalysts, perhaps catalyzing about 60 types of reactions. However, basically they catalyze reactions involving introduction of one atom of oxygen into the substrate and one into water.
<ul style="list-style-type: none"> Their hydroxylated products are more water-soluble than their generally lipophilic substrates, facilitating excretion.
<ul style="list-style-type: none"> Liver contains highest amounts, but found in most if not all tissues, including small intestine, brain, and lung.
<ul style="list-style-type: none"> Located in the smooth endoplasmic reticulum or in mitochondria (steroidogenic hormones).
<ul style="list-style-type: none"> In some cases, their products are mutagenic or carcinogenic.
<ul style="list-style-type: none"> Many have a molecular mass of about 55 kDa.
<ul style="list-style-type: none"> Many are inducible, resulting in one cause of drug interactions.
<ul style="list-style-type: none"> Many are inhibited by various drugs or their metabolic products, providing another cause of drug interactions.
<ul style="list-style-type: none"> Some exhibit genetic polymorphisms, which can result in atypical drug metabolism.
<ul style="list-style-type: none"> Their activities may be altered in diseased tissues (eg, cirrhosis), affecting drug metabolism.
<ul style="list-style-type: none"> Genotyping the P450 profile of patients (eg, to detect polymorphisms) may in the future permit individualization of drug therapy.

CONJUGATION REACTIONS PREPARE XENOBIOTICS FOR EXCRETION IN PHASE 2 OF THEIR METABOLISM

In phase 1 reactions, xenobiotics are generally converted to more polar, hydroxylated derivatives. In phase 2 reactions, these derivatives are conjugated with molecules such as glucuronic acid, sulfate, or glutathione. This renders them even more water-soluble, and they are eventually excreted in the urine or bile.

Five Types of Phase 2 Reactions Are Described Here

Glucuronidation

The glucuronidation of bilirubin is discussed in Chapter 31; xenobiotics are glucuronidated in the same way, using UDP-glucuronic acid, catalyzed by a variety of glucuronosyltransferases, present in both the endoplasmic reticulum and cytosol. Molecules such as 2-acetylaminofluorene (a carcinogen), aniline, benzoic acid, meprobamate (a tranquilizer), phenol, and many steroids are excreted as glucuronides. The glucuronide may be attached to oxygen, nitrogen, or sulfur groups of the substrates. Glucuronidation is probably the most frequent conjugation reaction.

Sulfation

Some alcohols, arylamines, and phenols are sulfated. The **sulfate donor** in these and other biologic and sulfation reactions (eg, sulfation of steroids, glycosaminoglycans, glycolipids, and glycoproteins) is **adenosine 3'-phosphate-5'-phosphosulfate (PAPS)** (see Chapter 24) – so-called “active sulfate.”

Conjugation With Glutathione

Glutathione S-transferases

The tripeptide glutathione (γ -glutamylcysteinylglycine) is important in the phase II metabolism of electrophilic compounds, forming glutathione S-conjugates that are excreted in urine and bile. The reaction catalyzed by glutathione S-transferases is:

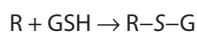

where R is an electrophilic compound.

There are four classes of cytosolic glutathione S-transferase and two classes of microsomal membrane-bound enzyme, as well as a structurally distinct kappa class that is found in mitochondria and peroxisomes. Glutathione S-transferases are homo- or heterodimers of at least seven different types of subunit, and different subunits are induced by different xenobiotics.

Because glutathione S-transferases also bind a number of ligands that are not substrates, including bilirubin, steroid hormones and some carcinogens and their metabolites, they are sometimes known as **ligandin**. Glutathione S-transferase

binds bilirubin at a site distinct from the catalytic site, transporting it from the bloodstream to the liver, then to the endoplasmic reticulum for conjugation with glucuronic acid, and excretion in the bile (see Chapter 31). Binding of carcinogens sequesters them, so preventing their actions on DNA.

The liver has a very high activity of glutathione S-transferase; in vitro the entire pool of glutathione can be depleted within minutes on exposure to xenobiotic substrates. The activity of glutathione S-transferase is upregulated in many tumors, leading to resistance to chemotherapy.

Glutathione conjugates may be transported out of the liver, where they are substrates for extracellular γ -glutamyltranspeptidase and dipeptidases. The resultant cysteine S-conjugates are taken up by other tissues (especially the kidney) and N-acetylated to yield mercapturic acids (N-acetyl cysteine S-conjugates) which are excreted in the urine. Some hepatic glutathione S-conjugates enter the bile canaliculi, where they are broken down to cysteine S-conjugates that are then taken up into the liver for N-acetylation, and re-excreted in the bile.

In addition to its role in phase 2 metabolism, glutathione has a number of other roles in metabolism:

1. It provides the reductant for the reduction of potentially toxic **hydrogen peroxide** to water in the reaction catalyzed by glutathione peroxidase.
2. It is an important **intracellular reductant and antioxidant**, helping to maintain essential -SH groups of enzymes in their reduced state. Its involvement in the hemolytic anemia caused by deficiency of glucose-6-phosphate dehydrogenase is discussed in Chapters 20 and 53.
3. A metabolic cycle involving GSH as a carrier has been implicated in the **transport of some amino acids** across membranes in the kidney. The first reaction of the cycle is shown below.

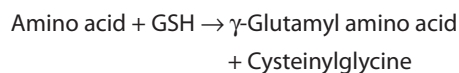

This reaction transfers amino acids across the plasma membrane, the amino acid being subsequently hydrolyzed from its complex with glutamate and the GSH being resynthesized from cysteinylglycine. The enzyme catalyzing the above reaction is **γ -glutamyltransferase (GGT)**. It is present in the plasma membrane of renal tubular cells and bile ductule cells, and in the endoplasmic reticulum of hepatocytes. The enzyme has some diagnostic value because it is released into the blood from hepatic cells in various hepatobiliary diseases (see Chapter 48).

Other Reactions

The two most important reactions other than conjugation are acetylation and methylation.

Acetylation—Acetylation is represented by

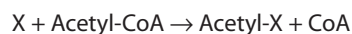

where X represents a xenobiotic. As for other acetylation reactions, **acetyl-CoA** is the acetyl donor. These reactions are

catalyzed by **acetyltransferases** present in the cytosol of various tissues, particularly liver. The drug **isoniazid**, used in the treatment of tuberculosis, is subject to acetylation. There is polymorphism of acetyltransferases, resulting in individuals who are classified as **slow or fast acetylators**. Slow acetylators are more subject to the toxic effects of isoniazid because the drug persists longer in these people.

Methylation—A few xenobiotics are subject to methylation by methyltransferases, employing *S*-adenosylmethionine (see Figure 29–18) as the methyl donor.

THE ACTIVITIES OF XENOBIOTIC-METABOLIZING ENZYMES ARE AFFECTED BY AGE, GENDER, & OTHER FACTORS

A variety of factors may affect the activities of the enzymes involved in metabolizing xenobiotics. The activities of these enzymes may differ substantially between **species**. Thus, for example, the possible **toxicity** or **carcinogenicity** of a xenobiotic cannot be extrapolated freely from an experimental animal to human beings or to another animal species. There are significant differences in enzyme activities between individuals, many of which appear to be due to **genetic factors**. The activities of some of these enzymes vary according to **age** and **gender**.

Intake of some xenobiotics can cause **enzyme induction**. It is thus important to know whether or not an individual has been exposed to these inducing agents in evaluating biochemical responses to xenobiotics. Metabolites of some xenobiotics can **inhibit** or **stimulate** the activities of xenobiotic-metabolizing enzymes. Again, this can affect the doses of certain drugs that are administered to patients. Various **diseases** (eg, cirrhosis of the liver) can affect the activities of drug-metabolizing

enzymes, sometimes necessitating adjustment of dosages of various drugs for patients with these disorders.

RESPONSES TO XENOBIOTICS INCLUDE PHARMACOLOGICAL, TOXIC, IMMUNOLOGICAL, & CARCINOGENIC EFFECTS

There are very few xenobiotics, including drugs, that do not have some toxic effects if the dose is large enough. The **toxic effects of xenobiotics** cover a wide spectrum, but the major effects can be considered under three general headings (Figure 47–1).

1. Covalent binding of xenobiotic metabolites to macromolecules including **DNA**, **RNA**, and **protein** can lead to cell injury (**cytotoxicity**), which can be severe enough to result in cell death. For example, in response to damage to DNA, the **DNA repair mechanisms** of the cell are activated. Part of this response involves the transfer of multiple ADP-ribose units onto DNA binding proteins, catalyzed by poly(ADP-ribose polymerase). The source of ADP-ribose is NAD, and in response to severe DNA damage there is considerable depletion of NAD. In turn this leads to severely impaired ATP formation, and cell death.
2. The reactive metabolite of a xenobiotic may bind to a protein, acting as a hapten, and altering its **antigenicity**. On its own it will not stimulate antibody production, but does so when bound to a protein. The resultant antibodies react not only with the modified protein but also with the unmodified protein, so potentially imitating **autoimmune disease**.
3. Reactions of activated species of chemical carcinogens with **DNA** are thought to be of great importance in **chemical**

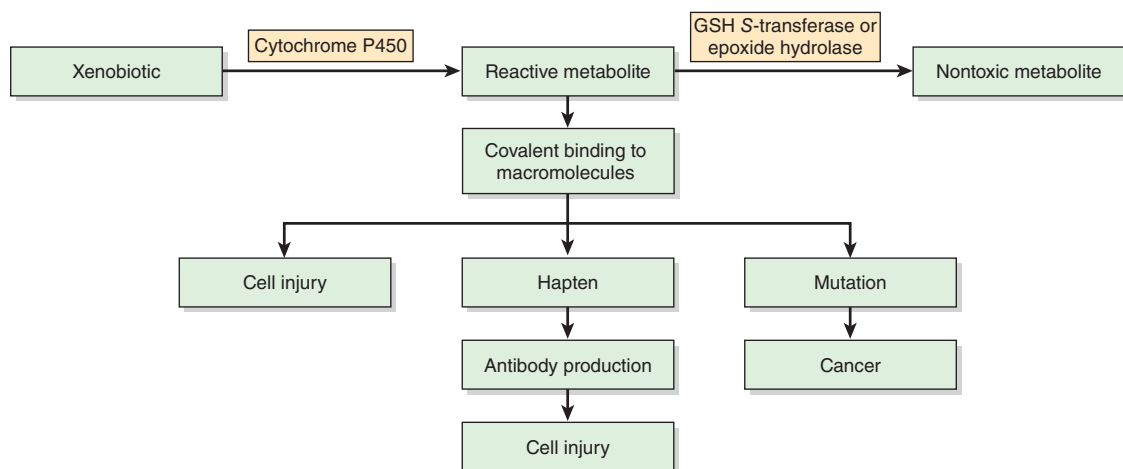

FIGURE 47–1 Simplified scheme showing how metabolism of a xenobiotic can result in cell injury, immunological damage, or cancer. In this instance, the conversion of the xenobiotic to a reactive metabolite is catalyzed by a cytochrome P450, and the conversion of the reactive metabolite (eg, an epoxide) to a nontoxic metabolite is catalyzed either by a GSH *S*-transferase or by epoxide hydrolase.

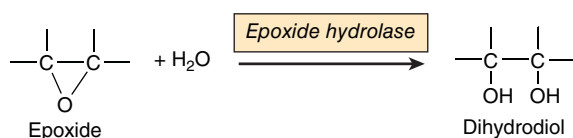

FIGURE 47-2 The reaction of epoxide hydrolase.

carcinogenesis. Some chemicals (eg, benzo[α]pyrene) require activation by cytochrome P450 in the endoplasmic reticulum to become carcinogenic (they are thus called **indirect carcinogens**). The activities of the xenobiotic-metabolizing enzymes present in the endoplasmic reticulum thus help to determine whether such compounds become carcinogenic or are “detoxified.”

The enzyme **epoxide hydrolase** is of interest because it can exert a protective effect against some carcinogens. The products of the action of cytochrome P450 on some procarcinogen substrates are **epoxides**. Epoxides are highly reactive and mutagenic or carcinogenic. Epoxide hydrolase is present in the membranes of the endoplasmic reticulum like cytochrome P450. It acts on these compounds, converting them into much less reactive dihydrodiols. The reaction catalyzed by epoxide hydrolase is shown in **Figure 47-2**.

SUMMARY

- Xenobiotics are chemical compounds foreign to the body, including drugs, food additives, and environmental pollutants, as well as naturally occurring compounds in plant foods.
- Xenobiotics are metabolized in two phases. The major reaction of phase 1 is hydroxylation catalyzed by a variety of monooxygenases, known as the cytochromes P450. In phase 2, the hydroxylated species are conjugated with a variety of hydrophilic compounds such as glucuronic acid, sulfate, or glutathione. The combined operation of these two phases converts lipophilic compounds into water-soluble compounds that can be excreted in urine or bile.
- Cytochromes P450 catalyze reactions that introduce one atom of oxygen derived from molecular oxygen into the substrate, yielding a hydroxylated product, and the other into water. NADPH and NADPH cytochrome P450 reductase are involved in the reaction mechanism.
- Cytochromes P450 are hemoproteins and generally have a wide substrate specificity, acting on many exogenous and

endogenous substrates. At least 57 cytochrome P450 genes are found in human tissue.

- Cytochromes P450 are generally located in the endoplasmic reticulum of cells, especially in the liver.
- Many cytochromes P450 are inducible. This has important implications for interactions between drugs.
- Mitochondrial cytochromes P450 also exist and are involved in cholesterol and steroid biosynthesis. They use a nonheme iron-containing sulfur protein, adrenodoxin, which is not required by microsomal isoforms.
- Phase 2 conjugation reactions are catalyzed by enzymes such as glucuronyltransferases, sulfotransferases, and glutathione S-transferases, using UDP-glucuronic acid, PAPS (active sulfate), and glutathione, respectively, as donors.
- Glutathione not only plays an important role in phase 2 reactions but is also an intracellular reducing agent.
- Xenobiotics can produce a variety of biological effects, including pharmacological responses, toxicity, immunological reactions, and cancer.

REFERENCES

- Caskey CT: Using genetic diagnosis to determine individual therapeutic utility. *Annu Rev Med* 2010;61:1.
- Cupp MJ, Tracy TS: Cytochrome P450: new nomenclature and clinical implications. *Am Fam Physician* 1998;57(1):107-116.
- Human Cytochrome P450 (CYP) Allele Nomenclature Committee. <http://www.imm.ki.se/CYPalleles/>
- Ingelman-Sundberg M: Pharmacogenomic biomarkers for prediction of severe adverse drug reactions. *N Engl J Med* 2008;358:637.
- Kalant H, Grant DM, Mitchell J (editors): *Principles of Medical Pharmacology*, 7th ed. Saunders Elsevier, 2007. (Chapters 4 [Drug Biotransformation by Riddick DS] and 10 [Pharmacogenetics and Pharmacogenomics by Grant DM and Kalow W] are particularly relevant to this chapter).
- Katzung BG, Masters SB, Trevor AJ (editors): *Basic & Clinical Pharmacology*, 12th ed. McGraw-Hill, 2011.
- Lee C, Morton CC: Structural genomic variation and personalized medicine. *N Engl J Med* 2008;358:740.
- Pharmacogenomics. Human Genome Project Information. http://www.ornl.gov/sci/techresources/Human_Genome/medicine.pharma.shtml
- Rang HP, Dale MM, James M, Ritter JM, Rod J, Flower RJ: *Rang & Dale's Pharmacology*, 7th ed. Churchill Livingstone, 2011.

Clinical Biochemistry

David A. Bender, PhD, Joe Varghese, MBBS, MD, Molly Jacob, MBBS, MD, PhD, & Robert K. Murray, MD, PhD

OBJECTIVES

After studying this chapter you should be able to:

- Explain the importance of laboratory tests in clinical and veterinary medicine.
- Explain what is meant by the reference range for the results of a test.
- Explain the difference between the precision and accuracy of an assay method, and explain the sensitivity and specificity of an assay method.
- Explain what is meant by the sensitivity, specificity and predictive value of a laboratory test.
- List techniques that are commonly used in a diagnostic lab carrying out biochemical tests and explain the principle of each method.
- List causes that result in abnormalities in levels of analytes in blood.
- Explain why high plasma concentrations of enzymes are considered to be indicators of tissue damage.
- Describe in outline the different requirements for measuring an enzyme in a plasma sample and using an enzyme to measure an analyte.
- Describe the main tests that can be used to assess kidney, liver, and thyroid function; describe markers of cardiovascular risk and gastro-intestinal function.

THE IMPORTANCE OF LABORATORY TESTS IN MEDICINE

Laboratory tests of one kind or another are an essential part of medicine. Biochemical tests can be used for screening for disease, for confirmation (or otherwise) of a diagnosis made on clinical examination, for monitoring progression of a disease and the outcome of treatment (**Table 48–1**). Blood and urine samples are most commonly used; occasionally feces, saliva, or cerebrospinal fluid may be used. On rare occasions, tissue biopsy samples may be used. Most of our knowledge and understanding of the underlying causes of metabolic diseases and of the effects of disease on metabolism has come from analysis of metabolites in blood and urine, and from measurement of enzymes in blood. In turn, that knowledge has permitted advances in the treatment of disease and the development of better drugs.

Advances in technology mean that many tests that were formerly carried out only in specialist laboratories can now be performed at the bedside, in the doctor's office or veterinary practice, sometimes even at home by patients themselves,

with automated machines that are simple to use and require only a limited amount of training to provide reliable results. Other tests are still conducted in hospital laboratories or by private clinical chemistry laboratories, with samples sent in by the referring physician. Some tests that are less commonly requested and may be technically more demanding are performed only in specialist centers. These often involve specialist techniques to study rare (and sometimes newly discovered) metabolic diseases. In addition, testing of samples from athletes (and race horses) for performance-enhancing drugs and other banned substances is normally carried out in only a limited number of specially licensed laboratories.

CAUSES OF ABNORMALITIES IN LEVELS OF ANALYTES MEASURED IN THE LABORATORY

A great many different conditions can lead to abnormalities of the results of laboratory tests; some of these are listed in **Table 48–2**. Tissue injury that results in damage to cell membranes and an increase in the permeability of the plasma membrane leads to

TABLE 48–1 Major Uses of Biochemical Tests With Selected Examples for Each

Early diagnosis of disease Use of plasma concentration of cardiac troponin I in early diagnosis of myocardial infarction
Suggestion of rational treatment of disease Elevated low density lipoprotein cholesterol is an indication for therapy with cholesterol-lowering drugs (eg, statins) in people at risk of cardiovascular disease
As screening tests for early diagnosis of disease Measurement of thyroid stimulating hormone (TSH) in diagnosis of congenital hypothyroidism
Monitoring the progression of disease Measurement of serum alanine aminotransferase (ALT) to monitor the progress of viral hepatitis
Assessment of the response of disease to therapy Measurement of TSH in patients being treated for hypo- or hyperthyroidism
Investigation of the causes and mechanisms of disease Demonstration of the nature of the genetic defect in cystic fibrosis

leakage of intracellular material into the bloodstream (eg, leakage of creatine kinase MB into the bloodstream following a myocardial infarction). In other cases, the synthesis of proteins and hormones is increased or decreased (eg, C-reactive protein [CRP] in inflammatory states, or hormones in endocrine disorders). Kidney and liver failure lead to the accumulation of a number of compounds (eg, creatinine and ammonia respectively) in the blood, due to an inability of the organ concerned to excrete or metabolize the compound concerned.

THE REFERENCE RANGE

For any compound that is measured (an **analyte**), there is a range of values around the average or mean that can be considered to be normal. This is the result of biological variations between individuals. In addition, day-to-day or week-to-week variations can occur in the results for the same individual. Therefore, the first step in establishing any new laboratory test for screening for, or diagnosis of, disease, or monitoring treatment, is to determine the range of results in a population of healthy people. For some tests, this will also mean determining the normal ranges of analytes in people of different ages. The normal range of some analytes will differ between men and women, and there may be differences between different ethnic groups to be considered as well.

If the results obtained for a target healthy population group (depending on age, gender, and perhaps ethnicity) are statistically normally distributed (ie, the results show a symmetrical Gaussian distribution around the mean), then the acceptable or normal range is taken to be $\pm 2x$ standard deviation around the mean. This range includes 95% of the target population, and is known as the reference range. Values outside the reference range are considered to be abnormal, meriting further investigation. If the results from the healthy population are not statistically normally distributed, but skewed, then a further

TABLE 48–2 Common Causes for Abnormalities in Blood Analytes With Selected Examples for Each

Various physiological conditions High serum and urine levels of human chorionic gonadotropin (hCG) in pregnancy; high blood lactate following strenuous exercise
Changes in fluid balance Hyponatremia (high serum sodium) in patients who are dehydrated due to excessive sweating or vomiting
Changes in blood pH Serum bicarbonate is low in metabolic acidosis (eg, diabetic ketoacidosis) and high in metabolic alkalosis (eg, severe vomiting due to pyloric stenosis)
Changes in endocrine function Serum TSH is low in primary hyperthyroidism and high in primary hypothyroidism
Changes in nutritional status Serum albumin and retinol binding protein are low in protein-energy malnutrition
Cell injury or death (necrosis) Serum creatine kinase MB is elevated in myocardial infarction; serum pancreatic amylase is elevated in pancreatitis
Acute or chronic inflammation (including infection) C-reactive protein is elevated in inflammation
Genetic diseases Plasma phenylalanine is elevated in phenylketonuria; serum ammonium is elevated in disorders of the urea cycle
Organ failure Serum creatinine and urea are elevated in renal failure; serum ammonium and bilirubin are elevated in liver failure
Trauma Serum myoglobin may be elevated following muscle injury
Cancer Various tumor markers (see Chapter 56) are elevated in specific cancers—eg, α -fetoprotein in hepatocellular cancer, prostate specific antigen in prostate cancer
Drugs Drugs used in cancer chemotherapy increase serum uric acid
Poisons Organophosphorus poisons decrease the activity of butyrylcholinesterase in blood
Others Stress increases serum cortisol and catecholamines

step of statistical manipulation is required before a 95% reference range can be established.

For some tests, the results from different laboratories will differ, usually because they use different methods of measurement. Each laboratory establishes its own set of reference ranges for the analyses it performs. Some laboratories report the results as the value to be compared with the reference range. Others report results as the number of standard deviations away from the mean—the so-called Z-score. This allows the physician to see how far from the mean the result is—in other words, how abnormal it is. Sometimes the results will be reported as 5 or 10 (or more) times above the upper limit of normal.

The use of the 95% range as the reference range has an unfortunate consequence. By chance, 5% of the “normal” results will be outside the reference range. This first became apparent in the 1970s, when multichannel analysers were developed that were capable of determining 20 or more analytes in each sample. Almost every sample gave one result that was outside the reference range, but if the same person gave a sample a few days later, that apparently abnormal result was now within the reference range, although by chance the result for another analyte might now be outside the reference range. Hence, it is incumbent on the physician to request only those tests that are relevant to the presumptive diagnosis, and not to ask for a complete biochemical screen.

VALIDITY OF LABORATORY RESULTS

Diagnostic laboratories are subject to inspection and regulatory procedures to assess the validity of their results and ensure **quality control** of their reports. Such measures will ensure that the value of the concentration, activity or amount of a substance in a specimen reported represents the best value obtainable with the method, reagents and instruments used and the technicians involved in obtaining and processing the specimen. In addition, it is important for medical staff to understand the validity of laboratory results and their interpretation.

In establishing a new test, or a new method, four questions have to be answered:

1. **How precise is the method?** This is a measure of the reproducibility of the method. If the same sample is analysed many times over, how much variation will be seen in the results obtained? **Figure 48-1** illustrates this. In this example, one set of results is much more precise than the other

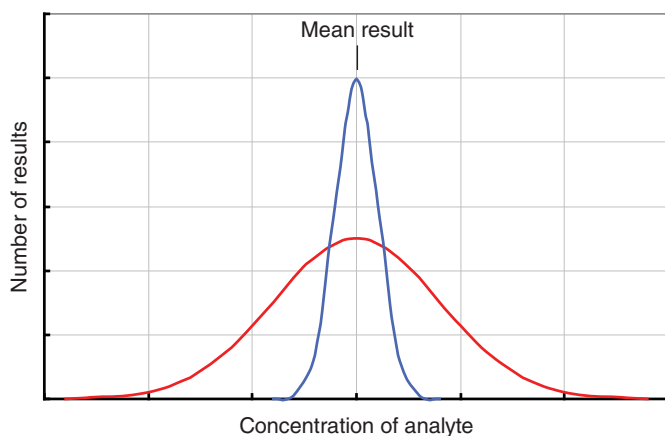

FIGURE 48-1 Precision of an analytical method. The graph shows the results of an analyte measured multiple times in the same sample, either by two different analytical methods or by the same method in two different laboratories. In both cases, the mean result is the same. However, one method or laboratory, shown in blue, has a low scatter of results, and hence a low standard deviation, and high precision, while the other, shown in red, has a high scatter of results, a high standard deviation, and low precision.

(there is a difference between the two in the spread of results around the mean), even though they have the same mean result. Precision is not absolute, but subject to variations inherent in the complexity of the method used, the stability of reagents, the sophistication of the equipment used for the assay and the skill of the technicians involved.

2. **How accurate is the result?** This is a measure of how close the result is to the true value. **Figure 48-2** shows the results of assays by two different methods or by the same method but in two different laboratories. Both have similar precision, but their mean values are very different. It is not possible to say from this information which laboratory is correct (and this is part of the reason why laboratories establish their own reference ranges). There are a number of national or regional quality control schemes in which all participating laboratories are sent the same (pooled) blood or urine sample. Each laboratory measures the various analytes in the pooled sample. The results obtained by all laboratories are plotted as a distribution curve. The mean of these values is calculated and considered to be the “true value.” Such a quality control scheme allows each participating laboratory to determine how close its results are to the “true value.”
3. **How sensitive is the method?** In other words, how little of the analyte can be determined reliably? What is the lower limit of reliable detection? This is obviously important when results below the reference range are clinically significant, or when samples are being analysed for narcotics or performance-enhancing substances that are banned in competitive sport.
4. **How specific is the method?** This question deals with the issue of confidence that the assay is actually measuring the analyte of interest. For example, the now obsolete method of measuring glucose in blood or urine used an alkaline copper (Cu^{2+}) solution, which was reduced to

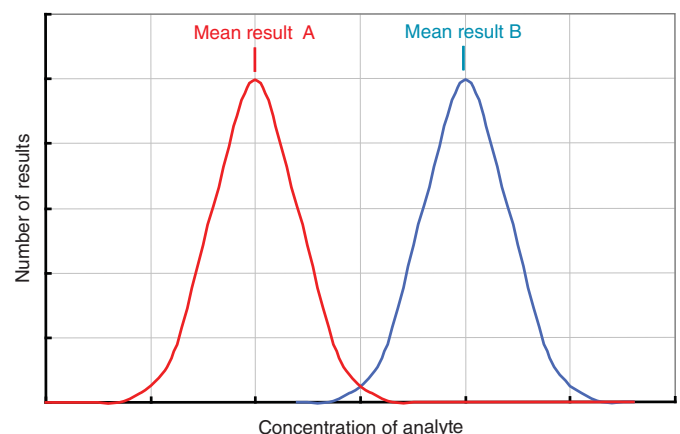

FIGURE 48-2 Accuracy of an analytical method. Two different analytical methods, performed on multiple samples, or the same method performed in two different laboratories, with the same scatter of results, and hence the same standard deviation and the same precision. However, the mean values of analytes obtained for the two methods or laboratories are very different; it is not possible to tell which result is closer to the true value.

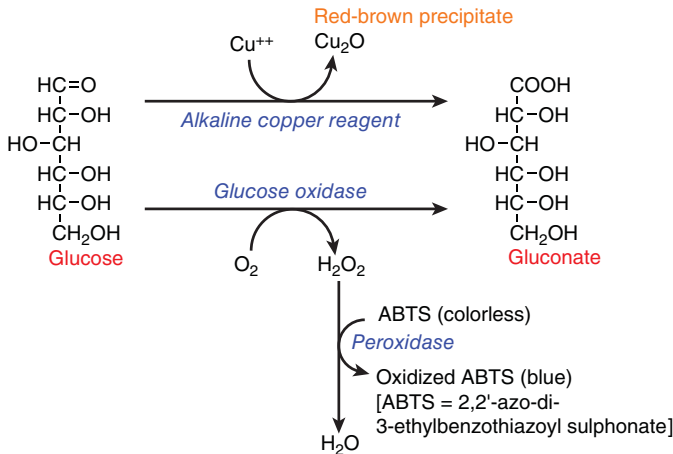

FIGURE 48-3 Specificity of an analytical method. Measurement of blood glucose by two methods. Chemical reduction of Cu^{2+} in alkaline solution will detect not only glucose, but any other reducing sugar and other substances such as vitamin C. Enzymic oxidation of glucose using glucose oxidase is a specific reaction; no other compound will be oxidized and contribute to the value obtained.

Cu^+ by glucose. However, other reducing compounds in urine or blood, such as xylose or vitamin C, also reduce glucose giving a falsely high value. Modern methods of measuring glucose depend on the enzyme glucose oxidase, which only reacts with glucose, and so is highly specific. However, one of the products of the action of glucose oxidase on glucose is hydrogen peroxide; the second step in the assay is to reduce the hydrogen peroxide produced to water and oxygen, using peroxidase. A colorless compound that turns blue when it is oxidized by the oxygen produced is also present in the assay medium. High concentrations of vitamin C, as would be seen when the patient is taking vitamin supplements, reduce the dye back to its colorless form, so giving a false-negative result (Figure 48-3).

ASSESSMENT OF CLINICAL VALIDITY OF A LABORATORY TEST

The above four criteria must be established for each analytical method. In addition, the **clinical value** of the test has to be established by taking into consideration its sensitivity, specificity and positive and negative predictive values (Table 48-3). Here, unfortunately, the same two terms, sensitivity and specificity, are used, but with very different meanings from those used in establishing the analytical method.

The **sensitivity** of a test refers to the **percentage of positive test results in patients with the disease (“true positive”)**. The test for phenylketonuria is highly sensitive; a positive test is obtained in all who have the disease (100% sensitivity). The carcinoembryonic antigen (CEA) test has lower sensitivity; only 72% of those with carcinoma of the colon test positive when the disease is extensive, and only 20% with early disease.

The **specificity** of a test refers to the **percentage of negative test results among people who do not have the disease**. The test for phenylketonuria is highly specific; 99.9% of normal individuals give a negative result. Only 0.1% gives a false-positive result. In contrast, the CEA test for carcinoma of the colon has a variable specificity; about 3% of nonsmoking individuals give a false-positive result (97% specificity), whereas 20% of smokers give a false-positive result (80% specificity).

The sensitivity and specificity of a test are inversely related to each other. If the cut-off point is set too high, then very few healthy people will give a false-positive result, but many people with the disease may give a false-negative result. The sensitivity will thus be low, but the specificity will be high. Conversely, if the cut-off point is too low then most or all of the people with the disease will be detected (the test will have a high sensitivity). However, more disease-free people may give a false-positive result (the test will have a low specificity).

TABLE 48-3 Sensitivity, Specificity, and Positive and Negative Predictive Values of a Laboratory Test

		Does the Patient Have the Disease?	
		Yes	No
What is the result of the test?	Positive	True positive (a)	False positive (b)
	Negative	False negative (c)	True negative (d)
Sensitivity	=	$\frac{\text{True positive (a)} \times 100}{\text{Number of patients who have the disease (a + c)}}$	
Specificity	=	$\frac{\text{True negative (d)} \times 100}{\text{Number of patients who do not have the disease (b + d)}}$	
Positive predictive value	=	$\frac{\text{True positive (a)} \times 100}{\text{Number of patients who have a positive test (a + b)}}$	
Negative predictive value	=	$\frac{\text{True negative (d)} \times 100}{\text{Number of patients who have a negative test (c + d)}}$	

Thus, often, there is a trade-off between sensitivity and specificity of a test.

The **predictive value of a positive test** (positive predictive value) defines the percentage of positive results that are true positives. Similarly, the **predictive value of a negative test** (negative predictive value) defines the percentage of negative results that are true negatives. This is related to the prevalence of the disease. For example, in a group of patients in a urology ward, the prevalence of renal disease is higher than in the general population. In this group, the serum concentration of creatinine will have a higher predictive value than in the general population. Formulae for calculating sensitivity, specificity and predictive values of a diagnostic test are shown in Table 48–3.

An ideal diagnostic test is one that has 100% sensitivity, 100% specificity, and 100% predictive value. However, this is not true for most, if not all, tests available nowadays. However, before ordering a test, it is important to attempt to determine whether the sensitivity, specificity and predictive value of the test are adequate to provide useful information. The result obtained should **influence diagnosis, therapy and prognosis or lead to a better understanding of the disease process, thus benefiting the patient.**

SAMPLES FOR ANALYSIS

The common samples for analysis are blood and urine. Blood is collected into tubes with or without an anticoagulant, depending on whether plasma or serum is required for the estimation. Less commonly, samples of saliva, cerebrospinal fluid, or feces may be used.

There is a difference between measurement of an analyte in a blood sample and in urine. The concentration of an analyte in blood reflects levels at the time the sample was taken, whereas a urine sample represents the cumulative excretion of the analyte over a period of time. A further difference is that it is usual to report results of blood tests as amount of analyte (or enzyme activity) per milliliter or liter of blood (or plasma or serum). Reporting the concentration of the analyte in urine in the same way is not useful, since urine volume depends very largely on fluid intake. In some cases the patient is asked to provide a complete 24-hour urine sample; this is a tedious procedure, and it is difficult to know whether there really has been a complete 24-hour collection. Alternatively, the concentration of the analyte is reported per mol of creatinine. Creatinine excretion is reasonably constant from day to day for any one individual, but varies between individuals because it depends mainly on muscle mass, because creatinine is formed nonenzymically from creatine and creatine phosphate, most of which is in skeletal muscle.

Apart from measurement of blood gases, for which arterial samples are required, blood samples are usually of venous blood. Blood glucose is often measured in capillary blood from a finger prick. Some analyses use whole blood; others require either serum or plasma. For a serum sample, the blood is allowed to clot, then the red cells and fibrin clot are removed by centrifugation. For a plasma sample, the blood is collected

into a tube containing an anticoagulant, and the red cells are removed by centrifugation. The difference between serum and plasma is that plasma contains prothrombin and the other clotting factors, including fibrinogen, while serum does not. Different anticoagulants are used for collection of plasma samples, depending on the assay to be performed: citrate, EDTA or oxalate, all of which chelate calcium and so inhibit coagulation. Heparin, which acts by activating antithrombin III, is another commonly used anticoagulant. For measurement of blood glucose, potassium fluoride is added, as an inhibitor of glycolysis by red blood cells.

TECHNIQUES USED IN CLINICAL CHEMISTRY

Most routine clinical chemistry reactions involve linking a chemical or enzymic reaction to the development of a colored product that is measured by **absorption spectrophotometry**. Different compounds absorb light at different wavelengths; the energy of the absorbed light excites electrons to an unstable orbital (**Figure 48–4**). The absorbance of light at a specific wavelength in the visible or ultraviolet range is directly proportional to the concentration of the colored end product, and hence to the concentration of the analyte in the sample. Although at one time such analyses were performed manually, nowadays most assays are automated, and a single instrument can carry out multiple assays on a single sample.

In absorption spectrophotometry the excited electrons return to their basal state in a series of small quantum jumps, emitting the energy absorbed as heat. For some compounds the electrons return to a lower energy state in a single quantum jump, emitting light of a higher wavelength (lower energy) than the exciting light. This is fluorescence, and the technique is known as **fluorescence spectrophotometry** or **spectrophotofluorimetry**. The sample is illuminated with light of a specific wavelength, and the light emitted is measured, at right angles to the direction of the illuminating wavelength (see **Figure 48–4**). Again the intensity of the fluorescence is proportional to the concentration of the fluorophore, and hence the concentration of the analyte. Fluorimetry permits both greater specificity and sensitivity of the analysis. The specificity is greater than for absorption spectrophotometry because both the exciting wavelength and the emitted wavelength are specific for the fluorophore, while for absorption spectrophotometry there is only one wavelength to be set, that of the light that is absorbed. Fluorimetry is more sensitive because it is easier to detect the emission of a small amount of light than the absorption.

Increasingly, especially in research and specialist centers, multiple analytes are measured in the same sample using **high-pressure liquid chromatography** to separate analytes, followed by colorimetric, fluorimetric, or electrochemical detection, or linked to mass spectrometry to identify compounds. Such methods form the basis of **metabolomics**, the study of a whole array of metabolites in a single sample, and

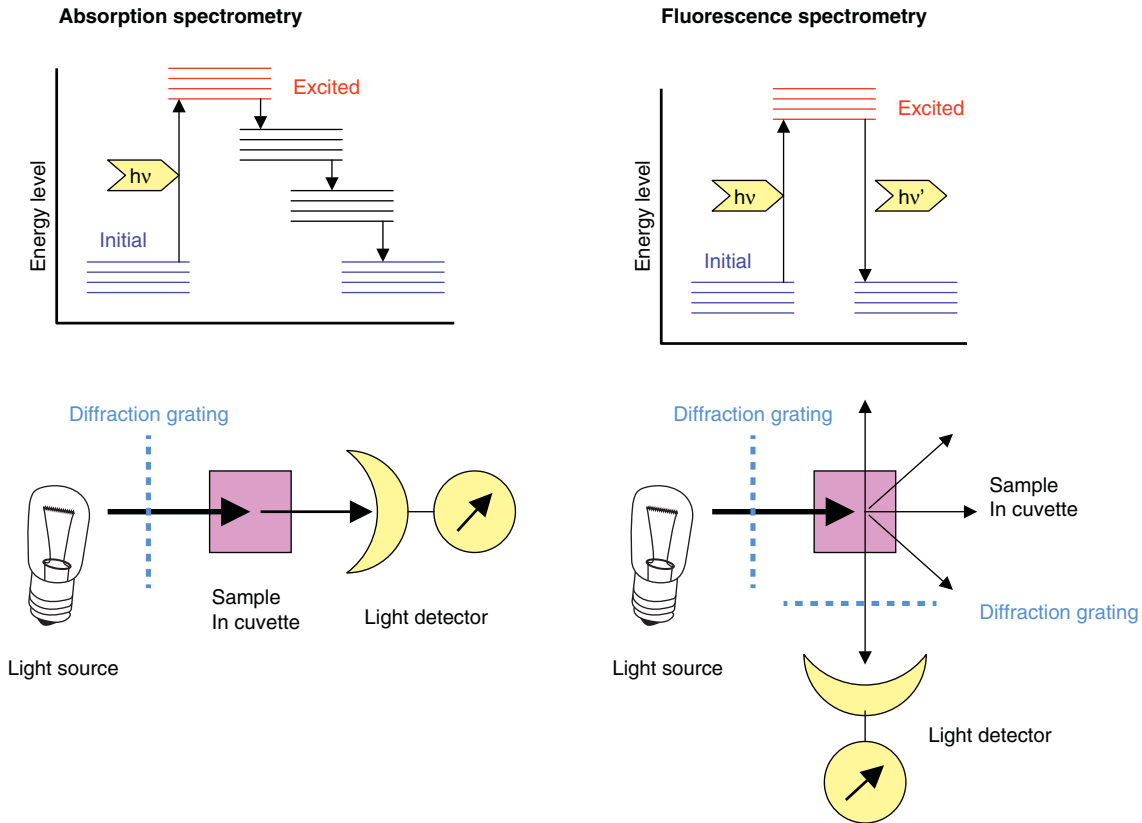

FIGURE 48-4 Absorption and fluorescence spectrometry. In absorption spectrometry, shown on the left, electrons are excited to an unstable higher energy level by the absorption of light, and then return to the basal energy level through a series of small quantum jumps. The energy is released as heat. The difference between the intensity of the exciting light and that transmitted through the sample, the absorbance, is proportional to the concentration of absorbing material in the cuvette (and the path length of the cuvette). In fluorescence spectrometry, shown on the right, the excited electrons return to the basal energy level in a single quantum jump. The energy is released as light of a lower energy (higher wavelength) than the exciting light. The intensity of the light emitted, measured at right angles to the exciting light, is proportional to the concentration of absorbing material in the cuvette (and the path length of the cuvette).

metabonomics, the study of changes in analytes in response to a drug or experimental treatment of some kind.

Historically, **electrolytes** such as sodium and potassium were measured by **flame photometry**, measuring the light emitted when the ion was introduced into a clear flame. Sodium gives a yellow flame and potassium a purple one. Nowadays these and other ions are measured using **ion-specific electrodes**. In some cases, metal ions are measured by **atomic absorption spectrometry**. Here the sample is introduced into a flame, and illuminated at a specific wavelength. The light energy absorbed excites electrons to an unstable orbital, and the absorption of light is directly proportional to the concentration of the element in the sample, as is the case for absorption spectrophotometry.

Enzymes in Clinical Chemistry

Enzymes are important in clinical chemistry in three different ways: to measure analytes in a sample, to measure the activity

of enzymes themselves in a sample, and as a test of vitamin nutritional status.

Using an enzyme to measure the concentration of an analyte confers a high degree of specificity on the assay, since in general an enzyme will act on only a single substrate, or a small range of closely related substrates, while a simple chemical reaction may well respond to a variety of (possibly unrelated) analytes. For example, as shown in Figure 48-3, a variety of reducing compounds will react with an alkaline copper reagent to give a false-positive result for glucose, whereas the enzymic assay using glucose oxidase will only give a positive result for glucose, and not other reducing compounds.

When an enzyme is used to detect an analyte, the limiting factor in the assay must be the analyte itself; the enzyme and other reagents must be present in excess. More importantly, the concentration of the analyte in the sample must be adjusted to be below the K_m of the enzyme, so that there is a large change in the rate of reaction with a small change in the concentration of the analyte (region A in Figure 48-5).

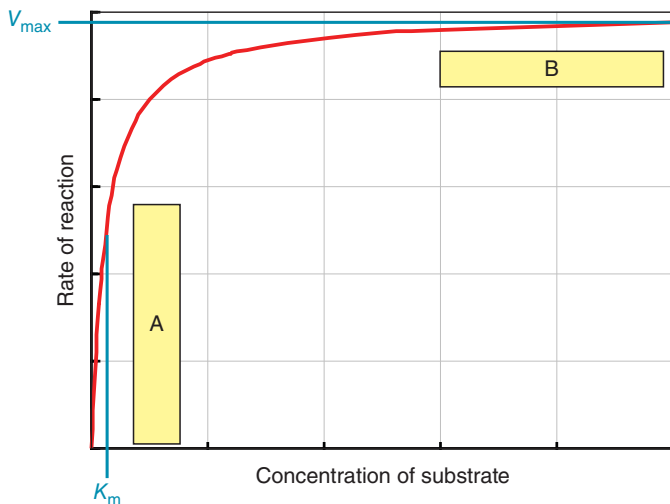

FIGURE 48-5 Use of enzymes to measure analytes and measurement of enzyme activity in biological samples. At concentrations of substrate (analyte) at or below the K_m of the enzyme (region A in the graph), there is a very sharp increase in the rate of reaction with a small change in the concentration of analyte, so the enzyme-linked assay has greatest sensitivity over this range of concentration. At concentrations of substrate considerably above the K_m of the enzyme, as the enzyme is approaching V_{max} , it is the amount of enzyme in the sample that is limiting for the rate of formation of product, so that this is the appropriate range of substrate concentration to use for measurement of enzyme activity in a biological sample.

When cells are damaged or die, their contents leak out into the bloodstream. Measurement of enzymes in plasma can therefore be used to detect tissue damage; information is obtained from the pattern of enzymes (and tissue-specific isoenzymes) released. The increase in enzyme activity in plasma above the normal range often indicates the degree of severity of tissue damage. When an assay is to determine the activity of an enzyme in plasma, the limiting factor must be the enzyme itself. The concentration of substrate added must be considerably in excess of the K_m of the enzyme, so that the enzyme is acting at or near V_{max} , and even a relatively large change in the concentration of substrate does not have a significant effect on the rate of reaction (region B in Figure 48-5). In practice, this means that the concentration of substrate added is about 20-fold higher than the K_m of the enzyme.

If an enzyme has a vitamin-derived coenzyme that is essential for activity, then measurement of the activity of the enzyme in red blood cells with and without added coenzyme can be used as an index of vitamin nutritional status. This provides an indication of functional nutritional status, while measurement of the vitamin and its derivatives commonly reflects recent intake rather than physiological adequacy. The underlying assumption is that red blood cells have to compete with other tissues in the body for what may be a limited supply of the coenzyme. Therefore the extent to which the red cell enzyme is saturated with its coenzyme will reflect the availability of the coenzyme over a period of time corresponding to the half-life of red cells. Such an assay consists of incubating two

samples of the red cell lysate: one has been preincubated with, and one without, addition of the coenzyme; then substrate is added to both, and the activity of the enzyme is measured. In the sample preincubated without addition of the coenzyme, only that enzyme that had coenzyme bound (the holoenzyme) will be active. In the sample that was preincubated with the coenzyme, any apoenzyme (inactive enzyme protein without bound coenzyme) will have been activated to the holoenzyme. There is, therefore, always either no change in enzyme activity on addition of coenzyme, indicating complete saturation of the enzyme with coenzyme, or an increase in activity, reflecting the activation of the apoenzyme by added coenzyme. The results are reported as an enzyme **activation coefficient** (the ratio of activity in the sample preincubated with coenzyme: that without). Reference ranges for the activation coefficient are established in the same way as for any other test. Such enzyme activation assays are available for thiamin (vitamin B₁, using red cell transketolase), riboflavin (vitamin B₂, using red cell glutathione reductase), and vitamin B₆ (using one or the other of the red cell transaminases).

Competitive Ligand Binding Assays and Immunoassays

If there is a protein that will bind an analyte, and bound and free analyte (ligand) can be separated and measured, then it is possible to devise an assay for the analyte. Perhaps the simplest such ligand-binding assay is that for the hormone cortisol, which is transported in the bloodstream bound to a specific cortisol-binding globulin. It is easy to prepare a plasma sample containing the binding globulin that has been stripped of its ligand (cortisol) by incubation with aluminum oxide or charcoal. This is done using a relatively large pooled plasma sample, and provides binding globulin for a large number of assays. The hormone is extracted from each sample to be analyzed, using an organic solvent, evaporated to dryness, then dissolved in ethanol and a suitable buffer, with the addition of a tracer amount of high specific activity radioactive hormone. Each sample is then incubated with the binding globulin at 37°C and then cooled to 4°C. Charcoal is added to adsorb the unbound ligand, and rapidly removed by centrifugation. The radioactivity in the supernatant is measured. This gives the amount of bound ligand, and is expressed as a percentage of the total radioactivity added to each sample. A standard curve is constructed using known amounts of hormone, so that the concentration of hormone in the sample can be determined.

A wide variety of other hormones and other analytes can be measured in the same way, by raising either monoclonal antibodies or polyclonal antisera against the analyte, eg, by injecting the analyte covalently bound to a protein into an animal. The antiserum against a hormone raised in a single rabbit can be used for many thousands of assays. Each batch of antiserum must, of course, be tested for its specificity for the hormone (ensuring that it does not also bind related hormones, an especial problem with steroid hormones), and for

its sensitivity. Where the binding protein is an antibody or antiserum, the assay is usually called a **radioimmunoassay**.

In a variant of the competitive binding assay, the antibody is bound covalently to the surface of beads. It is then easy to separate the bound and free ligand simply by washing the beads with ice-cold buffer, leaving the bound ligand attached to the beads for measurement of bound radioactivity. Alternatively, the antibody may be bound covalently to the surface of the test tube, or to each well in a multi-well plate. After incubation, a sample of the incubation medium is taken for measurement of the radioactivity that is not bound.

Increasingly, in order to minimize exposure to radioactive materials, fluorescently labeled ligand or antibody is used. A further development is the **sandwich assay**, in which two different antibodies against the ligand are used, each of which binds to a different region of the analyte. The first antibody is covalently bound to the surface of each well of a multiple well plate, and the sample is added and incubated. After removal of the incubation medium and washing each well, the second antibody is added, sandwiching the analyte between the two antibodies. The second antibody is labeled with a radioactive isotope or a fluorophore, thus permitting measurement of the bound second antibody, and hence bound ligand. In some cases, the second antibody is labeled with an enzyme, and measurement of bound second antibody, and hence bound ligand, is by measurement of the activity of the enzyme that is now bound to the wall of each cell of the plate, after washing to remove unbound second antibody and adding an excess of the enzyme substrate. This is the **enzyme-linked immunosorbent assay (ELISA)**.

Dry Chemistry Dipsticks

For a number of assays the enzymes or antibodies and reagents can be combined on a specially designed plastic strip. For measurement of blood glucose, a finger-prick blood sample is placed on the test strip and the concentration of glucose is measured using a handheld device called the glucometer. This provides a simple and reliable method to estimate glucose at the bedside in a hospital ward, a doctor's clinic or even at home. For urine testing, several different assays can be included as separate pellets on a plastic stick called a dipstick—eg, to detect or semi-quantitatively estimate levels of glucose, ketone bodies, protein, and several other analytes at the same time. Similar dipsticks are available to detect human chorionic gonadotropin (hCG) in urine, as a home pregnancy test.

Screening Neonates for Inborn Errors of Metabolism

Many of the inborn errors of metabolism can lead to very severe mental retardation if treatment is not initiated early enough. For conditions such as phenylketonuria and maple syrup urine disease, dietary restriction of the amino acids that are not metabolized normally (phenylalanine in phenylketonuria; the branched-chain amino acids leucine, isoleucine, and valine in maple syrup urine disease) is essential for

management of the condition. Therefore, it is usual in most developed countries to screen neonates for such conditions. The concentration of the offending amino acid(s) is measured in a blood sample that is normally taken a week after birth, when the enzymes that are affected in the disease should have reached full expression. Most commonly, a capillary blood sample is taken by heel prick, and is blotted onto absorbent paper to be sent to the laboratory for analysis.

The first such screening test for an inborn error of metabolism was the Guthrie bacterial inhibition test. A disk from the paper containing the blood sample is laid onto an agar plate that has been seeded with a phenylalanine-requiring strain of *Bacillus subtilis*, together with a competitive inhibitor of phenylalanine uptake into the bacteria (β -thienylalanine) at such a concentration that it will compete with phenylalanine at levels normally found in blood, so that the bacteria will not grow. If the concentration of phenylalanine is more than that usually found in blood, it will be taken up by the bacteria more than the inhibitor, and the bacteria will form visible colonies on the agar.

In most centers, the bacterial inhibition test has been superseded by chromatographic techniques that permit the detection of a variety of abnormal metabolites, and hence the detection of a variety of different inborn errors of metabolism.

ORGAN FUNCTION TESTS

Tests that provide information on the functioning of particular organs are often grouped together as organ function tests. Such grouped tests include tests of kidney, liver, and thyroid function.

Tests of Kidney Function

The major renal function tests are listed in Table 48–4. A complete **urinalysis** includes assessment of the physical and chemical characteristics of urine. Physical characteristics to be assessed include urine volume (this requires a timed urine sample, usually 24 hours), odor, color, appearance (clear or turbid), specific gravity, and pH. Protein, glucose, blood,

TABLE 48–4 Major Renal Function Tests

Urine analysis
<ul style="list-style-type: none"> • Physical characteristics—assessment of volume, color, odor, appearance, specific gravity and pH • Chemical characteristics—checking for the presence of protein, reducing sugar, ketone bodies, blood, bile salts and bile pigments • Microscopy—checking for the presence of WBCs, RBCs and casts
Serum markers of renal function
<ul style="list-style-type: none"> • Serum creatinine • Serum urea (or blood urea nitrogen (BUN))
Estimation of glomerular filtration rate (GFR)
<ul style="list-style-type: none"> • Creatinine clearance • Inulin clearance
Tests of renal tubular function
<ul style="list-style-type: none"> • Water deprivation test • Urine acidification test

TABLE 48-5 Abnormal Constituents of Urine

Constituent	Clinical Significance	Examples of Conditions in Which Present
Protein	Glomerular proteinuria refers to the presence of albumin in urine due to a breach in the integrity of the glomerular basement membrane.	Nephrotic syndrome, acute glomerulonephritis, diabetic nephropathy, etc.
	Overflow proteinuria is due to the presence of abnormally high levels of low molecular weight proteins in the plasma that are filtered by the glomerulus and thus appear in the urine.	Multiple myeloma (light chains of immunoglobulins appear in urine, resulting in Bence-Jones proteinuria).
	Tubular proteinuria refers to the presence of low molecular weight proteins (like β_2 -microglobulin) in urine, due to impaired reabsorption of these proteins by the proximal tubule.	Fanconi syndrome, nephrotoxicity due to aminoglycoside antibiotics, heavy metals, etc.
	Postrenal proteinuria refers to the presence of proteins in urine derived from the urinary tract.	Urinary tract infection (UTI) resulting in inflammatory exudates in urine.
Glucose	Hyperglycemic glucosuria: Presence of glucose in urine is usually seen when plasma glucose rises above the renal threshold of ~180 mg/dL.	Uncontrolled diabetes mellitus.
	Renal glucosuria: Presence of glucose in urine due to impaired reabsorption of glucose in the proximal tubule.	Fanconi syndrome and inherited defects in the sodium glucose transporter 2 (SGLT2).
Ketone bodies	Detectable levels in urine (ketonuria) are seen in conditions characterized by increased ketogenesis.	Diabetic ketoacidosis and starvation ketoacidosis.
Blood	Hematuria refers to the presence of red blood cells in urine, due to bleeding into the urinary tract.	Renal stones or urinary tract infections.
	Hemoglobinuria refers to the presence of hemoglobin in urine, which occurs due to intravascular hemolysis.	Incompatible blood transfusions, malaria, etc.
Bile salts and bile pigments	Presence of these in urine is associated with obstruction of the biliary tract.	Gall stone or carcinoma of the head of pancreas, obstructing the common bile duct.

ketone bodies, bile salts, and bile pigments are abnormal constituents of urine that appear in different disease conditions (Table 48-5).

Urea and creatinine are excreted in urine; their serum concentrations can be used as markers of renal function because the serum concentration increases as renal function deteriorates. Creatinine is a better marker of renal function than urea because its blood concentration is not significantly affected by nonrenal factors, thus making it a specific indicator of renal function. A number of “prerenal” and “postrenal” factors significantly increase blood urea levels.

Normally, less than 150 mg of protein, and less than 30 mg of albumin, is excreted in urine per 24 hours. This is below the limit of detection by routine tests. Presence of protein in excess of this is referred to as **proteinuria** and is an important sign of renal disease. The most common cause of proteinuria is loss of integrity of the glomerular basement membrane (glomerular proteinuria), as seen in nephrotic syndrome and diabetic nephropathy. The major protein found in glomerular proteinuria is albumin. Other important causes of proteinuria are listed in Table 48-5. **Microalbuminuria** is defined as the presence of 30 to 300 mg of albumin in a 24-hour urine sample. It is an early marker of renal damage in diabetes mellitus.

Even though serum creatinine is a marker of renal function, a significant increase in its blood concentration is seen only when there has been about a 50% decline in the glomerular filtration rate (GFR). Measurement of serum creatinine is therefore a test with poor sensitivity. Measurement of **creatinine**

clearance gives an estimate of the GFR, and so can be used to detect the early stages of renal failure. **Clearance** is the volume of plasma from which a compound is completely cleared by the kidney in unit time. It is calculated by the formula:

$$\text{Clearance (mL/min)} = (U \times V)/P$$

where U is concentration of the measured analyte in a timed sample of urine (usually 24 hours); P is plasma concentration of the analyte; and V is volume of urine produced per minute (calculated by dividing the value for the volume of urine collected over 24 hours by 1440 [24 × 60]).

A compound that is useful for measurement of renal clearance has a fairly constant blood concentration, is excreted only in urine, is freely filtered at the glomerulus, and is neither reabsorbed nor secreted by the renal tubules. Although creatinine clearance is commonly measured, it overestimates GFR because it is secreted by the renal tubules to a small extent. Inulin clearance is the gold standard method for measuring GFR, as it satisfies all the criteria essential for a compound to be used in clearance tests. However, unlike creatinine, inulin is an exogenous compound that has to be infused intravenously at a constant rate.

Liver Function Tests

Liver function tests (LFTs) are a group of tests that help in diagnosis, assessing prognosis and monitoring therapy of liver disease (Table 48-6). Each test assesses a specific aspect

TABLE 48–6 Important Liver Function Tests

Test	Aspect of Liver Function Assessed	Major Utility
Serum bilirubin levels (total and conjugated)	Indicator of the ability of the liver to take up, conjugate and excrete bilirubin (conjugation and excretory function).	Aids in the differential diagnosis of jaundice (see Table 31–3).
Total serum protein and albumin	Measure of the biosynthetic function of the liver, as the liver is the primary site of synthesis of most plasma proteins.	Indicator of chronic liver disease.
Prothrombin time	Measure of the biosynthetic function of the liver, as several coagulation factors are synthesized in the liver.	Indicator of severity of acute and chronic liver disease.
Serum enzymes:		
Aspartate transaminase (AST)	Serves as marker of injury to hepatocytes that contain AST in abundance.	Activities of serum AST and ALT are early indicators of liver damage. They also help in monitoring response to treatment.
Alanine transaminase (ALT)	Serves as marker of injury to hepatocytes that contain ALT in abundance.	
Alkaline phosphatase (ALP)	Serves as marker of biliary obstruction.	Aids in diagnosis of obstruction of the biliary tract.
Blood ammonia	Indicator of the ability of the liver to detoxify ammonia.	Levels are elevated in cirrhosis of liver with portal hypertension and in disorders of the urea cycle.

of liver function. An increase in **serum bilirubin** occurs due to many causes, and results in **jaundice**. In obstruction of the bile duct (obstructive jaundice), it is mainly conjugated bilirubin that increases. In hepatocellular disease, both conjugated and unconjugated bilirubin are often elevated, reflecting the inability of the liver to take up, conjugate and excrete bilirubin into the bile (see Chapter 31). Total serum protein and albumin levels are low in chronic liver diseases, such as cirrhosis. Prothrombin time (PT, Chapter 55) may be prolonged in acute disorders of the liver because of impaired synthesis of coagulation factors.

The activities of serum alanine (ALT) and aspartate (AST) aminotransferases (see Chapter 28) are significantly elevated several days before onset of jaundice in acute viral hepatitis. ALT is considered to be more specific for liver disease than AST, because AST is elevated in cases of cardiac or skeletal muscle injury while ALT is not. Serum alkaline phosphatase (ALP) activity is elevated in obstructive jaundice. A high activity of serum ALP is also seen in bone disease.

The liver is also the primary site for detoxification of ammonia (in the urea cycle, Chapter 28). Elevation of blood ammonia is an important sign of liver disease and plays an important role in the pathogenesis of hepatic encephalopathy in patients with liver cirrhosis and portal hypertension. Blood ammonia is also elevated in genetic disorders of the urea cycle.

The albumin:globulin ratio (A:G ratio) often provides useful clinical information. The normal ratio varies between 1.2:1 and 1.6:1. A reversal of the A:G ratio may be seen in conditions where the albumin levels are low (hypoalbuminemia) or where globulins are abnormally high, eg, multiple myeloma. Reversal of the A:G ratio is often the first investigation that raises suspicion of multiple myeloma.

Thyroid Function Tests

The thyroid gland secretes the thyroid hormones—thyroxine or tetraiodothyronine (T_4) and tri-iodothyronine (T_3). Diseases associated with increased or decreased synthesis of thyroid hormones (hyperthyroidism and hypothyroidism respectively) occur commonly. A clinical diagnosis of a thyroid disorder is confirmed by measurement of serum thyroid stimulating hormone and free thyroxine and tri-iodothyronine.

Measurement of **thyroid stimulating hormone (TSH)** is often the first test performed in the assessment of thyroid function. The serum concentration of TSH is high in primary hypothyroidism and low or undetectable in primary hyperthyroidism. Measurement of free thyroxine and tri-iodothyronine will help establish the diagnosis in most cases where an abnormal TSH value is obtained (Table 48–7).

The concentration of total serum thyroxine can be affected by changes in the concentration of thyroid-binding globulin (TBG), in the absence of thyroid disease. Total thyroxine is seldom measured nowadays, because assays to measure free thyroxine are now available. Additional tests, such as measurement

TABLE 48–7 Laboratory Diagnosis of Thyroid Disorders

		TSH Level	
		High	Low
Free thyroxine level	High	Secondary hyperthyroidism ^a	Primary hyperthyroidism
	Low	Primary hypothyroidism	Secondary hypothyroidism ^a

^aSecondary hyper- and hypothyroidism are much rarer than primary hyper- and hypothyroidism.

of thyroid autoantibodies, are also available. For example, Graves disease is commonly associated with presence of antibodies against the TSH receptor, while autoimmune thyroiditis (Hashimoto thyroiditis) is associated with the presence of antibodies against thyroid peroxidase.

Adrenal Function Tests

A clinical diagnosis of adrenal hyper-function (Cushing syndrome) or hypofunction (Addison disease) is confirmed by adrenal function tests. Secretion of cortisol from the adrenal gland shows diurnal variation; serum cortisol is highest during the early morning hours and lowest around midnight. Loss of this diurnal variation is one of the earliest signs of adrenal hyperfunction. Measurement of serum cortisol in blood samples drawn at midnight and 8 AM is, therefore, useful as a screening test. A diagnosis of adrenal hyperfunction is confirmed by demonstration of failure of suppression of the early morning concentration of cortisol following the administration of 1 mg dexamethasone (a potent synthetic glucocorticoid) at midnight; this is the **dexamethasone suppression test**. Measurement of adrenocorticotrophic hormone (ACTH) can help differentiate between hypercortisolism due excessive ACTH production (ACTH-dependent) from conditions, where ACTH production is normal or suppressed (ACTH-independent). Failure to increase serum cortisol following a single dose of synacthen (a synthetic analogue of ACTH) is diagnostic of adrenal hypofunction (**synacthen stimulation test**). Additional biochemical tests and imaging techniques (CT or MRI scans) may be required to diagnose the cause of adrenal hyper- or hypofunction.

Markers of Cardiovascular Risk and Myocardial Infarction

As discussed in Chapter 25, plasma total cholesterol, and especially the ratio of LDL:HDL cholesterol provides an index of the risk of developing atherosclerosis. The plasma lipoproteins were originally separated by centrifugation, hence their classification by density. Later methods involved separation by electrophoresis. Nowadays, total plasma cholesterol is measured, then lipoproteins containing apoprotein B (see Table 25–1) are precipitated using a divalent cation, allowing measurement of the cholesterol associated with HDL.

An electrocardiogram may not always show typical changes following a myocardial infarction. In such a situation, elevation in serum levels of cardiac troponin or creatine kinase MB isoenzyme provides confirmation of the occurrence of a myocardial infarction, as both of these markers are specific to cardiac muscle.

Markers of Gastrointestinal Function

Gastric infection with *Helicobacter pylori*, the underlying cause of most **peptic ulcers**, is mainly by detecting antibodies against the organism in plasma or feces. However, *H. pylori*

has an active urease, and hydrolyses urea to ammonium and carbon dioxide; this production of ammonium permits the organism to survive in the acid conditions of the stomach. An early diagnostic test, and one that is still used to confirm the eradication or persistence of infection after antibiotic treatment, is based on giving a dose of [¹³C]urea, then measuring the isotope in exhaled carbon dioxide. Atypical peptic ulcers, due to excessive secretion of gastrin (commonly the result of a gastrin-secreting tumor, a gastrinoma) can be tested by measurement of the fasting plasma concentration of gastrin by immunoassay.

In **acute pancreatitis**, the plasma activity of amylase is increased, although in mild cases it may be normal, because amylase is small enough for some to be filtered at the glomerulus and excreted in the urine. This means that measurement of urine amylase is also useful in the diagnosis of this condition. Serum pancreatic lipase level is also elevated in acute pancreatitis and is considered to be more specific for pancreatitis than is amylase, which is also synthesized in the salivary glands

Disaccharidase deficiencies were formerly tested by giving a relatively large dose of the suspected offending disaccharide and measuring the increase in blood glucose. Typically, a dose of 50 g of lactose was used to test for **alactasia**. In an alactasic patient, this was a large enough dose to cause severe abdominal pain and explosive watery diarrhea because of intestinal bacterial metabolism of the unabsorbed lactose. A more recent test involves administration of only a small amount of the disaccharide, followed by measurement of hydrogen exhaled in the breath as a result of intestinal bacterial metabolism.

SUMMARY

- Laboratory tests can provide useful information for diagnosis and treatment of disease as well as providing information about normal metabolism and the pathology of disease.
- The reference range of an analyte is the range ± 2 x standard deviations around the mean value for the population group under consideration. Values outside this reference range are suggestive of an abnormality that merits further investigation.
- The precision of an analytical method is a measure of its reproducibility; the accuracy of a method is a measure of how close the result is to the true value.
- The sensitivity of an analytical method is a measure of how little of the analyte can be detected. The specificity is the extent to which other compounds present in the sample may give a false positive result.
- The sensitivity of a test refers to the percentage of patients with the disease who will give a positive result. The specificity of a test is the percentage of patients without the disease who will give a negative result.
- Samples for analysis are usually blood and urine, although saliva, feces and cerebrospinal fluid are also used sometimes. Blood samples may be collected in tubes containing an anticoagulant (for plasma samples) or without (for serum samples).

- Many laboratory tests rely on production of a colored product that can be measured by absorption spectrophotometry or fluorimetry.
- Many compounds can be measured by high pressure liquid chromatography, sometimes in conjunction with mass spectrometry. The measurement of a large number of analytes in a sample is the basis of metabolomics, and of metabonomics, which is the effect of a disease, drug or other treatment on metabolism.
- Enzymes may be used to provide sensitive and specific assay methods for analytes. In this case there must be an excess of enzyme in the sample, so that the limiting factor is the concentration of the analyte in the sample.
- Many enzymes are released into the bloodstream from dying cells in disease, and their measurement can give useful diagnostic and prognostic information. In order to determine the activity of an enzyme in a sample, there must be an excess of substrate, so that the limiting factor is the amount of enzyme present.
- Many analytes (and especially hormones) are measured by competitive binding assays, using either a naturally occurring binding protein or an antiserum or monoclonal antibody to bind the ligand. Trace amounts of high specific activity radioactive ligand, or fluorescently-labelled ligand or binding protein are used.

REFERENCES

- Beckett G, Walker S, Rae P, Ashby P: *Clinical Biochemistry*. 8th ed. Wiley-Blackwell, 2010.
- Bishop ML, Fody EP, Schoeff LE: *Clinical Chemistry Techniques, Principles, Correlations*. 6th ed. Wolters Kluwer, Lippincott Williams & Wilkins, 2010.
- Burtis CA, Ashwood ER, Bruns DE (editors): *Tietz Textbook of Clinical Chemistry and Molecular Diagnostics*. 4th ed. Elsevier Saunders, 2006.
- Gaw A, Murphy MJ, Cowan RA, et al: *Clinical Biochemistry*. 4th ed. Churchill Livingstone, 2008.
- Kratz A, Pesce MA, Fink DJ: Appendix: Laboratory Values of Clinical Importance. *Harrison's Principles of Internal Medicine*. 17th ed. Fauci AS et al (editors). McGraw-Hill, 2008.
- Krieg AF, Gambino R, Galen RS: Why are clinical laboratory tests performed? When are they valid? *JAMA* 1975;233:76.
- Lab Tests Online: www.labtestsonline.org (A comprehensive web site provided by the American Association of Clinical Chemists that provides accurate information on many laboratory tests).
- Laposaka M: *Laboratory Medicine*. McGraw-Hill Lange, 2010.
- Marshall WJ, Bangert SK, Lapsley M: *Clinical Chemistry*. 7th ed. Mosby, 2012.
- MedlinePlus: <http://www.nlm.nih.gov/medlineplus/encyclopedia.html> (The A.D.A.M. Medical Encyclopedia includes over 4000 articles about diseases, lab tests and other matters)

Exam Questions

Section IX – Special Topics (A)

- Which of the following will be elevated in the bloodstream about 1 to 2 hours after eating a high-fat meal?
 - Chylomicrons
 - High density lipoprotein
 - Ketone bodies
 - Nonesterified fatty acids
 - Very low density lipoprotein
- Which of the following will be elevated in the bloodstream about 4 to 5 hours after eating a high-fat meal?
 - Chylomicrons
 - High-density lipoprotein
 - Ketone bodies
 - Nonesterified fatty acids
 - Very low density lipoprotein
- Which of the following is the best definition of glycemic index?
 - The increase in the blood concentration of glucagon after consuming the food compared with that after an equivalent amount of white bread.
 - The increase in the blood concentration of glucose after consuming the food.
 - The increase in the blood concentration of glucose after consuming the food compared with that after an equivalent amount of white bread.
 - The increase in the blood concentration of insulin after consuming the food.
 - The increase in the blood concentration of insulin after consuming the food compared with that after an equivalent amount of white bread.
- Which of the following will have the lowest glycemic index?
 - A baked apple
 - A baked potato
 - An uncooked apple
 - An uncooked potato
 - Apple juice
- Which of the following will have the highest glycemic index?
 - A baked apple
 - A baked potato
 - An uncooked apple
 - An uncooked potato
 - Apple juice
- Which one of the following statements concerning chylomicrons is CORRECT?
 - Chylomicrons are made inside intestinal cells and secreted into lymph, where they acquire apolipoproteins B and C.
 - The core of chylomicrons contains triacylglycerol and phospholipids.
 - The enzyme hormone sensitive lipase acts on chylomicrons to release fatty acids from triacylglycerol when they are bound to the surface of endothelial cells in blood capillaries.
 - Chylomicron remnants differ from chylomicrons in that they are smaller and contain a lower proportion of triacylglycerol.
 - Chylomicrons are taken up by the liver.
- Plant sterols and stanols inhibit the absorption of cholesterol from the gastrointestinal tract. Which of the following best describes how they act?
 - They are incorporated into chylomicrons in place of cholesterol.
 - They compete with cholesterol for esterification in the intestinal lumen, so that less cholesterol is esterified.
 - They compete with cholesterol for esterification in the mucosal cell, and unesterified cholesterol is actively transported out of the cell into the intestinal lumen.
 - They compete with cholesterol for esterification in the mucosal cell, and unesterified cholesterol is not incorporated into chylomicrons.
 - They displace cholesterol from lipid micelles, so that it is not available for absorption.
- Which one of following statements about energy metabolism is CORRECT?
 - Adipose tissue does not contribute to basal metabolic rate (BMR).
 - Physical activity level (PAL) is the sum of physical activity ratios for different activities throughout the day, multiplied by the time spent in each activity, expressed as a multiple of BMR.
 - Physical activity ratio (PAR) is the energy cost of physical activity throughout the day.
 - Resting metabolic rate (RMR) is the energy expenditure of the body when asleep.
 - The energy cost of physical activity can be determined by measuring respiratory quotient (RQ) production during the activity.
- A patient with metastatic colorectal cancer has lost 6 kg of body weight over the last month. Which of the following is the best explanation for her weight loss?
 - Because of the tumour she is oedematous.
 - Chemotherapy has caused nausea and loss of appetite.
 - Her basal metabolic rate has fallen as a result of protein catabolism caused by tumour necrosis factor and other cytokines.
 - Her basal metabolic rate has increased as a result of anaerobic glycolysis in the tumour and the energy cost of gluconeogenesis from the resultant lactate in her liver.
 - The tumour has a very high energy requirement for cell proliferation.
- A 5-year-old child arriving at a refugee center in East Africa is stunted in growth (only 89% of expected height for age) but not oedematous. Would you consider him to be:
 - Suffering from kwashiorkor
 - Suffering from marasmic kwashiorkor
 - Suffering from marasmus

- D. Suffering from undernutrition
E. Underfed but not considered to be clinically malnourished
11. A 5-year-old child arriving at a refugee center in East Africa is stunted in growth (only 55% of expected height for age) but not oedematous. Would you consider him to be:
- A. Suffering from kwashiorkor
B. Suffering from marasmic kwashiorkor
C. Suffering from marasmus
D. Suffering from undernutrition
E. Underfed but not considered to be clinically malnourished
12. Which of the following is the definition of nitrogen balance?
- A. Protein intake as a percentage of total energy intake
B. The difference between protein intake and excretion of nitrogenous compounds
C. The ratio of excretion of nitrogenous compounds/protein intake
D. The ratio of protein intake/excretion of nitrogenous compounds
E. The sum of protein intake and excretion of nitrogenous compounds
13. Which one of following statements about nitrogen balance is CORRECT?
- A. If the intake of protein is greater than requirements, there will always be positive nitrogen balance.
B. In nitrogen equilibrium the excretion of nitrogenous metabolites is greater than the dietary intake of nitrogenous compounds.
C. In positive nitrogen balance the excretion of nitrogenous metabolites is less than the dietary intake of nitrogenous compounds.
D. Nitrogen balance is the ratio of intake of nitrogenous compounds/output of nitrogenous metabolites from the body.
E. Positive nitrogen balance means that there is a net loss of protein from the body.
14. In a series of experiments to determine amino acid requirements, healthy young adult volunteers were fed mixtures of amino acids as their sole protein source. Which of the following mixtures would lead to negative nitrogen balance (assuming that all other amino acids are provided in adequate amounts)?
- A. One lacking alanine, glycine, and tyrosine
B. One lacking arginine, glycine, and cysteine
C. One lacking asparagine, glutamine, and cysteine
D. One lacking lysine, glycine, and tyrosine
E. One lacking proline, alanine, and glutamate
15. Which of the following vitamins provides the cofactor for reduction reactions in fatty acid synthesis?
- A. Folate
B. Niacin
C. Riboflavin
D. Thiamin
E. Vitamin B₆
16. Deficiency of which one of these vitamins is a major cause of blindness worldwide?
- A. Vitamin A
B. Vitamin B₁₂
C. Vitamin B₆
D. Vitamin D
E. Vitamin K
17. Deficiency of which one of these vitamins may lead to megaloblastic anaemia?
- A. Vitamin B₆
B. Vitamin B₁₂
C. Vitamin D
D. Vitamin E
E. Vitamin K
18. Which one of the following criteria of vitamin adequacy can be defined as "There are no signs of deficiency under normal conditions, but any trauma or stress reveals the precarious state of the body reserves and may precipitate clinical signs"?
- A. Abnormal response to a metabolic load
B. Clinical deficiency disease
C. Covert deficiency
D. Incomplete saturation of body reserves.
E. Subclinical deficiency
19. Which one of the following criteria of vitamin adequacy can be defined as metabolic abnormalities under normal conditions?
- A. Abnormal response to a metabolic load
B. Clinical deficiency disease
C. Covert deficiency
D. Incomplete saturation of body reserves
E. Subclinical deficiency
20. Which of the following is the best definition of the reference nutrient intake (RNI) or recommended daily amount (RDA), of a vitamin or mineral?
- A. One standard deviation above the average requirement of the population group under consideration
B. One standard deviation below the average requirement of the population group under consideration
C. The average requirement of the population group under consideration
D. Two standard deviations above the average requirement of the population group under consideration
E. Two standard deviations below the average requirement of the population group under consideration
21. What percentage of the population will have met their requirement for a vitamin or mineral if their intake is equal to the RNI or RDA?
- A. 2.5%
B. 5%
C. 50%
D. 95%
E. 97.5%
22. What percentage of the population will have met their requirement for a vitamin or mineral if their intake is equal to the lower reference nutrient intake (LRNI)?
- A. 2.5%
B. 5%
C. 50%
D. 95%
E. 97.5%

23. What percentage of the population will have met their requirement for a vitamin or mineral if their intake is equal to the average requirement?
- 2.5%
 - 5%
 - 50%
 - 95%
 - 97.5%
24. For a person whose intake of a vitamin or mineral is equal to the average requirement, what is the probability that this level of intake is adequate to meet his/her individual requirement?
- 2.5%
 - 5%
 - 50%
 - 95%
 - 97.5%
25. For a person whose intake of a vitamin or mineral is equal to the LRNI, what is the probability that this level of intake is adequate to meet his/her individual requirement?
- 2.5%
 - 5%
 - 50%
 - 95%
 - 97.5%
26. For a person whose intake of a vitamin or mineral is equal to the RNI, what is the probability that this level of intake is adequate to meet his/her individual requirement?
- 2.5%
 - 5%
 - 50%
 - 95%
 - 97.5%
27. Which one of the following is NOT a source of oxygen radicals?
- Action of superoxide dismutase
 - Activation of macrophages
 - Nonenzymic reactions of transition metal ions
 - Reaction of β -carotene with oxygen
 - Ultraviolet radiation
28. Which one of the following provides protection against oxygen radical damage to tissues?
- Action of superoxide dismutase
 - Activation of macrophages
 - Nonenzymic reactions of transition metal ions
 - Reaction of β -carotene with oxygen
 - Ultraviolet radiation
29. Which one of the following is NOT the result of oxygen radical action?
- Activation of macrophages
 - Modification of bases in DNA
 - Oxidation of amino acids in apoproteins of LDL
 - Peroxidation of unsaturated fatty acids in membranes
 - Strand breaks in DNA
30. Which of the following types of oxygen radical damage may lead to the development of autoimmune thyroid disease?
- Chemical modification of DNA bases in somatic cells
 - Chemical modification of DNA in germ-line cells
 - Oxidation of amino acids in cell membrane proteins
 - Oxidation of amino acids in mitochondrial proteins
 - Oxidation of unsaturated fatty acids in plasma lipoproteins
31. Which of the following types of oxygen radical damage may lead to the development of atherosclerosis and coronary heart disease?
- Chemical modification of DNA bases in somatic cells
 - Chemical modification of DNA in germ-line cells
 - Oxidation of amino acids in cell membrane proteins
 - Oxidation of amino acids in mitochondrial proteins
 - Oxidation of unsaturated fatty acids in plasma lipoproteins
32. Which of the following types of oxygen radical damage may lead to the development of cancer?
- Chemical modification of DNA bases in somatic cells
 - Chemical modification of DNA in germ-line cells
 - Oxidation of amino acids in cell membrane proteins
 - Oxidation of amino acids in mitochondrial proteins
 - Oxidation of unsaturated fatty acids in plasma lipoproteins
33. Which of the following types of oxygen radical damage may lead to the development of hereditary mutations?
- Chemical modification of DNA bases in somatic cells
 - Chemical modification of DNA in germ-line cells
 - Oxidation of amino acids in cell membrane proteins
 - Oxidation of amino acids in mitochondrial proteins
 - Oxidation of unsaturated fatty acids in plasma lipoproteins
34. Which one of the following best explains the antioxidant action of vitamin E?
- It forms a stable radical that can be reduced back to active vitamin E by reaction with vitamin C.
 - It is a radical, so that when it reacts with another radical a nonradical product is formed.
 - It is converted to a stable radical by reaction with vitamin C.
 - It is lipid soluble and can react with free radicals in the blood plasma resulting from nitric oxide (NO) formation by vascular endothelium.
 - Oxidized vitamin E can be reduced back to active vitamin E by reaction with glutathione and glutathione peroxidase.
35. Which of the following best describes the glycome?
- The DNA coding for glycosyltransferases
 - The full complement of all carbohydrates in the body
 - The full complement of free sugars in cells and tissues
 - The full complement of glycoproteins and glycolipids in the body
 - The full complement of glycosyltransferases in the body
36. Which of the following methods CANNOT be used to determine the structures of glycoproteins?
- Carbohydrate microarrays
 - Degradation using endo- and exoglycosidases
 - Genome analysis
 - Mass spectrometry
 - Sepharose-lectin chromatography
37. Which of the following is NOT a function of glycoproteins?
- Anchoring proteins at the cell surface
 - Protecting plasma proteins against clearance by the liver

- C. Providing a transport system for folate into cells
 D. Providing a transport system for uptake of low-density lipoprotein into the liver
 E. Providing cell surface recognition signals
38. Which of the following is NOT a constituent of glycoproteins?
 A. Fucose
 B. Galactose
 C. Glucose
 D. Mannose
 E. Sucrose
39. Which of the following is used as a sugar donor in the synthesis of the common pentasaccharide of *N*-linked glycoproteins?
 A. CMP-*N*-acetylneuraminic acid
 B. Dolichol pyrophosphate *N*-acetylglucosamine
 C. Dolichol pyrophosphate-mannose
 D. GDP-fucose
 E. UDP-*N*-acetylglucosamine
40. Which of the following is NOT used as a sugar donor in the synthesis of *N*-linked glycoproteins in the endoplasmic reticulum?
 A. Dolichol pyrophosphate fructose
 B. Dolichol pyrophosphate galactose
 C. Dolichol pyrophosphate mannose
 D. Dolichol pyrophosphate *N*-acetylglucosamine
 E. Dolichol pyrophosphate *N*-acetylneuraminic acid
41. Which of the following best describes the attachment of the common pentapeptide to the apoprotein in synthesis of an *N*-linked glycoprotein?
 A. Direct glycation of the amino terminal amino acid of the peptide
 B. Displacement of the amino terminal region of the peptide in a transamidation reaction
 C. Displacement of the amino terminal region of the peptide in a transamination reaction
 D. Displacement of the carboxy terminal region of the peptide in a transamidation reaction
 E. Displacement of the carboxy terminal region of the peptide in a transamination reaction
42. Which of the following is NOT a glycoprotein?
 A. Collagen
 B. Immunoglobulin G
 C. Serum albumin
 D. Thyroid stimulating hormone
 E. Transferrin
43. Which one of the following statements is INCORRECT?
 A. Calnexin ensures the correct folding of glycoproteins in the endoplasmic reticulum.
 B. Dolichol-pyrophosphate oligosaccharide donates all of the sugars found in *N*-linked glycoproteins.
 C. Mucins contain predominantly *O*-linked glycans.
 D. *N*-Acetylneuraminic acid is commonly found at the termini of *N*-linked sugar chains of glycoproteins.
 E. *O*-linked sugar chains of glycoproteins are built up by the stepwise addition of sugars from sugar nucleotides.
44. Which of the following is NOT an activity of cytochrome P450?
 A. Activation of vitamin D
 B. Hydroxylation of steroid hormone precursors
 C. Hydroxylation of xenobiotics
 D. Hydroxylation of retinoic acid
 E. Methylation of xenobiotics
45. Which of the following best described the reaction of a cytochrome P450?
 A. $\text{RH} + \text{O}_2 + \text{NADP}^+ \rightarrow \text{R-OH} + \text{H}_2\text{O} + \text{NADPH}$
 B. $\text{RH} + \text{O}_2 + \text{NAD}^+ \rightarrow \text{R-OH} + \text{H}_2\text{O} + \text{NADH}$
 C. $\text{RH} + \text{O}_2 + \text{NADPH} \rightarrow \text{R-OH} + \text{H}_2\text{O} + \text{NADP}^+$
 D. $\text{RH} + \text{O}_2 + \text{NADPH} \rightarrow \text{R-OH} + \text{H}_2\text{O}_2 + \text{NADP}^+$
 E. $\text{RH} + \text{O}_2 + \text{NADH} \rightarrow \text{R-OH} + \text{H}_2\text{O} + \text{NAD}^+$
46. Which of the following is the preferred lipid component of the cytochrome P450 system?
 A. Dolichol phosphate
 B. Phosphatidylcholine
 C. Phosphatidylethanolamine
 D. Phosphatidylinositol
 E. Phosphatidylserine
47. Which of the following best describes the drug interactions between phenobarbital and warfarin?
 A. Phenobarbital induces CYP2C9, and this results in decreased catabolism of warfarin.
 B. Phenobarbital induces CYP2C9, and this results in increased catabolism of warfarin.
 C. Phenobarbital represses CYP2C9, and this results in increased catabolism of warfarin.
 D. Warfarin induces CYP2C9, and this results in decreased catabolism of phenobarbital.
 E. Warfarin induces CYP2C9, and this results in increased catabolism of phenobarbital.
48. Which of the following best describes the effects of polymorphisms of CYP2A6?
 A. People with the active allele are less likely to become tobacco-dependent smokers because this cytochrome inactivates nicotine to cotinine.
 B. People with the inactive (null) allele are less likely to become tobacco-dependent smokers because this cytochrome inactivates nicotine to cotinine.
 C. People with the inactive (null) allele are less likely to become tobacco-dependent smokers because this cytochrome activates nicotine to cotinine.
 D. People with the inactive (null) allele are more likely to become tobacco-dependent smokers because this cytochrome inactivates nicotine to cotinine.
 E. People with the inactive (null) allele are more likely to become tobacco-dependent smokers because this cytochrome activates nicotine to cotinine.
49. Which of the following is NOT a function of glutathione?
 A. Coenzyme for the reduction of hydrogen peroxide
 B. Conjugation of bilirubin
 C. Conjugation of some products of phase I metabolism of xenobiotics
 D. Transport of amino acids across cell membranes
 E. Transport of bilirubin in the bloodstream

50. Which of the following best describes the reference range for a laboratory test?
- A range $\pm 1 \times$ standard deviation around the mean value
 - A range $\pm 1.5 \times$ standard deviation around the mean value
 - A range $\pm 2 \times$ standard deviation around the mean value
 - A range $\pm 2.5 \times$ standard deviation around the mean value
 - A range $\pm 3 \times$ standard deviation around the mean value
51. Which of the following statements about laboratory tests is INCORRECT?
- The predictive value of a test is the extent to which it will correctly predict whether or not a person has the disease.
 - The sensitivity and specificity of a test are inversely related.
 - The sensitivity of a test is a measure of how many people with the disease will give a positive result.
 - The specificity of a test is a measure of how many people with the disease will give a positive result.
 - The specificity of a test is a measure of how many people without the disease will give a negative result.
52. Which of the following is CORRECT when an enzyme is used to measure an analyte in a blood sample?
- The concentration of substrate must be about 20-times the K_m of the enzyme.
 - The concentration of substrate must be equal to the K_m of the enzyme.
 - The concentration of substrate must be equal to or lower than the K_m of the enzyme.
 - The concentration of the substrate in the assay is not important.
 - The concentration of substrate must be about 1/20th of the K_m of the enzyme.
53. Which of the following is CORRECT when an enzyme is being measured in a blood sample?
- The concentration of substrate must be about 20-times the K_m of the enzyme.
 - The concentration of substrate must be equal to the K_m of the enzyme.
 - The concentration of substrate must be equal to or lower than the K_m of the enzyme.
 - The concentration of the substrate in the assay is not important.
 - The concentration of substrate must be about 1/20th of the K_m of the enzyme.
54. Which of the following best explains the use of enzyme activation assays to assess vitamin nutritional status?
- Adding the vitamin-derived cofactor to the incubation converts previously inactive apoenzyme into active holoenzyme.
 - Adding the vitamin-derived cofactor to the incubation converts previously inactive holoenzyme into active apoenzyme.
 - Adding the vitamin-derived cofactor to the incubation converts previously active holoenzyme into inactive apoenzyme.
 - Adding the vitamin-derived cofactor to the incubation converts previously active apoenzyme into inactive holoenzyme.
 - Adding the vitamin-derived cofactor to the incubation leads to a reduction in enzyme activity.
55. Which of the following would be used to prepare serum from a blood sample?
- A plain tube
 - A tube containing citrate
 - A tube containing EDTA
 - A tube containing oxalate
 - An evacuated tube to exclude oxygen
56. Which of the following would be used to take a blood sample for blood gas analysis?
- A plain tube
 - A tube containing citrate
 - A tube containing EDTA
 - A tube containing oxalate
 - An evacuated tube to exclude oxygen
57. Which of the following best explains the difference between creatinine clearance and inulin clearance as tests of renal function?
- Creatinine clearance is higher than inulin clearance because creatinine is actively secreted in the distal renal tubules.
 - Creatinine clearance is higher than inulin clearance because inulin is actively secreted in the proximal renal tubules.
 - Creatinine clearance is higher than inulin clearance because inulin is actively secreted in the distal renal tubules.
 - Creatinine clearance is lower than inulin clearance because creatinine is actively secreted in the distal renal tubules.
 - Creatinine clearance is lower than inulin clearance because inulin is not completely filtered at the glomerulus.

This page intentionally left blank

Intracellular Traffic & Sorting of Proteins

Kathleen M. Botham, PhD, DSc & Robert K. Murray, MD, PhD

OBJECTIVES

After studying this chapter, you should be able to:

- Know that many proteins are targeted by signal sequences to their correct destinations and that the Golgi apparatus plays an important role in sorting proteins.
- Understand that specialized signals are involved in sorting proteins to mitochondria, the nucleus, and to peroxisomes.
- Appreciate that N-terminal signal peptides play a key role in directing newly synthesized proteins into the lumen of the endoplasmic reticulum.
- Know that chaperones prevent faulty folding of other proteins, that mechanisms exist for disposing of misfolded proteins, and that the endoplasmic reticulum acts as a quality control compartment.
- Explain the role of ubiquitin as a key molecule in protein degradation.
- Recognize the important role of transport vesicles in intracellular transport.
- Appreciate that many diseases result from mutations in genes encoding proteins involved in intracellular transport and be familiar with the terms conformational diseases and diseases of proteostatic deficiency.

BIOMEDICAL IMPORTANCE

Inside the cell, proteins are synthesized on polyribosomes, but perform their particular functions at many different subcellular locations. Some are destined to be components of specific organelles, others for the cytosol or the various cellular membranes, and yet others are for export. Thus, there is considerable **intracellular traffic of proteins**. It was first recognized by Blobel in 1970 that for proteins to attain their proper locations, they generally contain **information** (a signal or coding sequence) that **targets** them appropriately. This led to the identification of a number of the specific signals (see **Table 49–1**), and it became apparent that **certain diseases** result from mutations that affect these signals. In this chapter, we discuss the intracellular traffic of proteins and their sorting and briefly consider some of the disorders that result when abnormalities occur.

MANY PROTEINS ARE TARGETED BY SIGNAL SEQUENCES TO THEIR CORRECT DESTINATIONS

The protein biosynthetic pathways in cells can be considered to be **one large sorting system**. Many proteins carry **signals** (usually but not always specific sequences of amino acids) that direct them to their destination, thus ensuring that they are delivered to the appropriate membrane or cell compartment; these signals are a fundamental component of the sorting system. Usually, the signal sequences are recognized and interact with complementary areas of other proteins that serve as receptors for those containing the signals.

A major sorting decision is made early in protein biosynthesis, when specific proteins are synthesized either on **free** or

TABLE 49-1 Sequences or Molecules That Direct Proteins to Specific Organelles

Targeting Sequence or Compound	Organelle Targeted
N-terminal signal peptide	ER
Carboxyl-terminal KDEL sequence (Lys-Asp-Glu-Leu) in ER-resident proteins in COPI vesicles	Lumen of ER
Di-acidic sequences (eg, Asp-X-Glu) in membrane proteins in COPII vesicles	Golgi membranes
Amino terminal sequence (20-50 residues)	Mitochondrial matrix
NLS (eg, Pro ₂ -Lys ₃ -Arg-Lys-Val)	Nucleus
PTS (eg, Ser-Lys-Leu)	Peroxisome
Mannose 6-phosphate	Lysosome

Abbreviations: NLS, nuclear localization signal; PTS, peroxisomal-matrix targeting sequence.

on **membrane-bound polyribosomes**. The **signal hypothesis** was proposed by Blobel and Sabatini in 1971 partly to explain the distinction between free and membrane-bound polyribosomes. They proposed that proteins synthesized on membrane-bound polyribosomes contained an N-terminal peptide extension (**N-terminal signal peptide**) which causes them to become attached to the membranes of the ER (**membrane bound polyribosomes**), and facilitates protein transfer into the ER lumen. On the other hand, polyribosomes synthesizing proteins lacking the signal peptide would retain free movement in the cytosol (**cytosolic polyribosomes**). An important aspect of the signal hypothesis is that **all ribosomes have the same structure**, and that the distinction between membrane-bound and free ribosomes depends solely on the former carrying proteins that have signal peptides. Because many membrane proteins are synthesized on membrane-bound polyribosomes, the signal hypothesis plays an important role in **concepts of membrane assembly**. ER regions containing attached polyribosomes are called the **rough ER**, and the distinction between the two types of ribosomes results in two branches of the protein-sorting pathway, called the **cytosolic branch** and the **rough ER (RER) branch** (Figure 49-1).

Proteins synthesized by cytosolic polyribosomes are directed to mitochondria, nuclei, and peroxisomes by specific signals, or remain in the cytosol if they lack a signal. Any protein that contains a targeting sequence that is subsequently removed is designated as a **preprotein**. In some cases, a second peptide is also removed, and in that event the original protein is known as a **preproprotein** (eg, prealbumin; see Chapter 52).

Proteins synthesized and sorted in the **RER branch** (Figure 49-1) include many destined for various membranes (eg, of the ER, Golgi apparatus [GA], plasma membrane [PM]) as well as lysosomal enzymes, and also those for **export from the cell via exocytosis** (secretion). These various proteins may thus reside in the membranes or lumen of the ER,

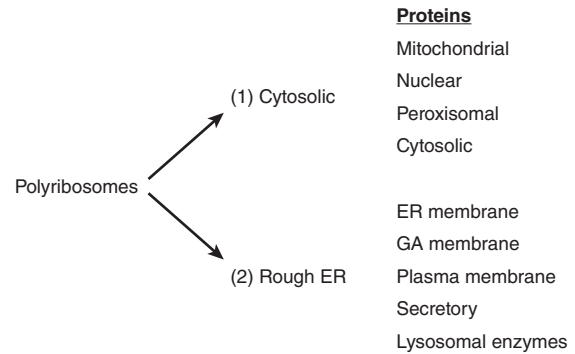

FIGURE 49-1 The two branches of protein sorting. Proteins are synthesized on cytosolic (free) polyribosomes or membrane bound polyribosomes in the rough ER. Mitochondrial proteins encoded by nuclear genes are derived from the cytosolic pathway. (ER, endoplasmic reticulum; GA, Golgi apparatus.)

or follow the major transport route of intracellular proteins to the GA. In the **secretory or exocytotic pathway**, proteins are transported from the ER → GA → PM and then released into the external environment. Proteins destined for the GA, the PM, certain other sites, or for secretion are carried in **transport vesicles** (Figure 49-2); a brief description of the formation of these important particles will be given subsequently. Certain other proteins destined for secretion are carried in **secretory vesicles** (Figure 49-2). These are particularly prominent in the pancreas and certain other glands. Their mobilization and discharge are switched on and off when required and often referred to as “**regulated secretion**.” In contrast, transport of vesicles occurring continuously through the secretory pathway is referred to as “**constitutive transport**.” Passage of enzymes to the lysosomes using the mannose 6-phosphate signal is described in Chapter 46.

The Golgi Apparatus Is Involved in Glycosylation & Sorting of Proteins

The **GA** plays two major roles in protein synthesis. First, it is involved in the **processing of the oligosaccharide chains** of membrane and other N-linked glycoproteins and also contains enzymes involved in O-glycosylation (see Chapter 46). Second, it is involved in the **sorting** of various proteins prior to their delivery to their appropriate intracellular destinations. All parts of the GA participate in the first role, whereas the **trans-Golgi network** (TGN) is particularly involved in the second and is very rich in vesicles.

Chaperones Are Proteins That Stabilize Unfolded or Partially Folded Proteins

Molecular chaperones are proteins which **stabilize unfolded or partially folded intermediates**, allowing them time to fold properly, and prevent inappropriate interactions, thus combating the formation of nonfunctional structures. Most chaperones exhibit **ATPase activity** and bind ADP and ATP. This activity is important for their effect on protein folding. The ADP-chaperone complex often has a high affinity for the unfolded

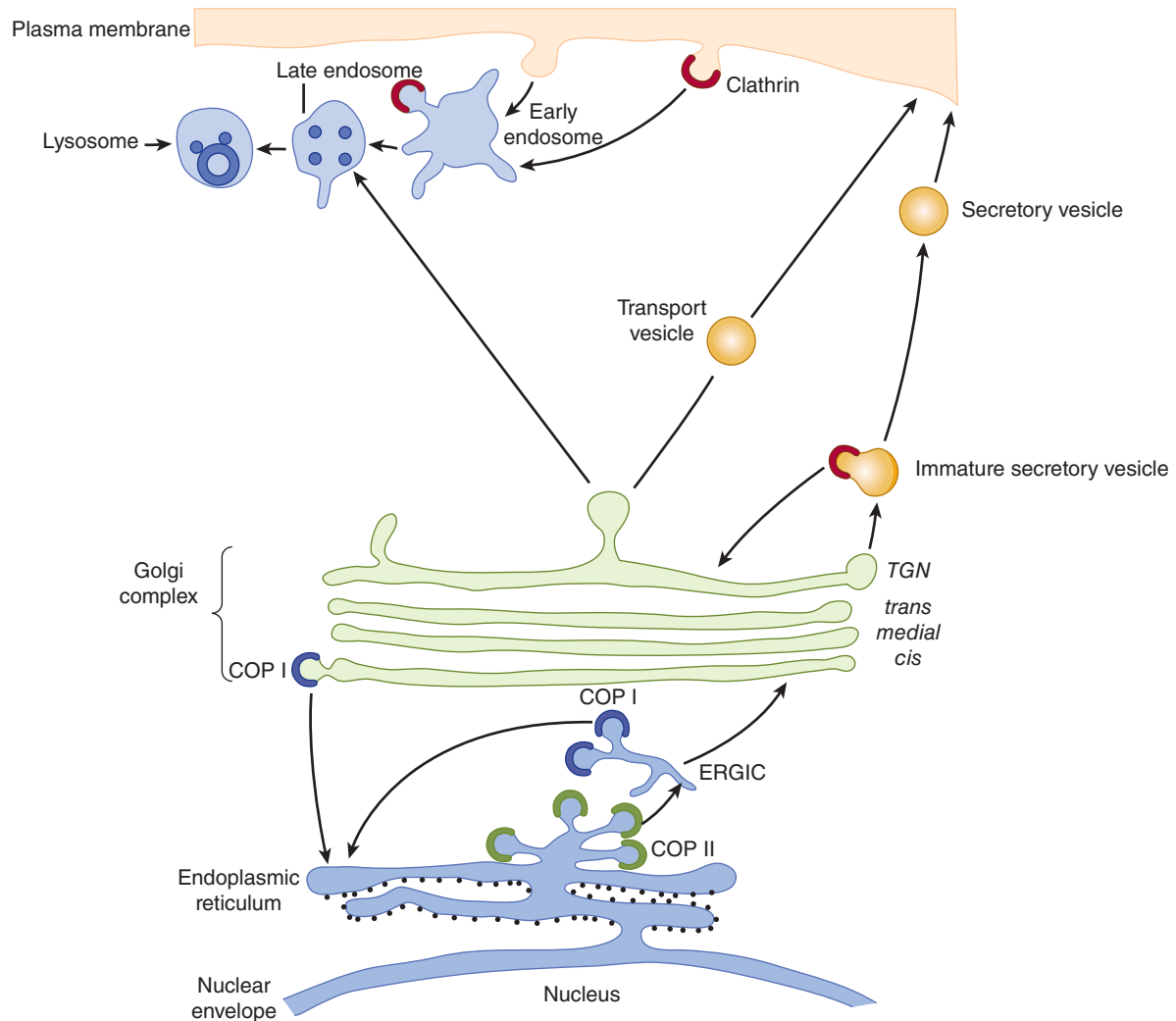

FIGURE 49–2 The rough ER branch of protein sorting. Newly synthesized proteins are inserted into the ER membrane or lumen from membrane-bound polyribosomes (small black circles studding the cytosolic face of the ER). Proteins that are transported out of the ER are carried in COPII vesicles to the *cis*-Golgi (anterograde transport). Proteins move through the Golgi as the cisternae (sac-like structures) mature. In the *trans*-Golgi network (TGN), the exit side of the Golgi, proteins are segregated and sorted. For regulated secretion, proteins accumulate in secretory vesicles, while proteins destined for insertion in the plasma membrane for constitutive secretion are carried out to the cell surface in transport vesicles. Clathrin-coated vesicles are involved in endocytosis, carrying cargo to late endosomes and to lysosomes. Mannose 6-phosphate (not shown; see Chapter 46) acts as a signal for transporting enzymes to lysosomes. COPI vesicles transport protein from GA to the ER (retrograde transport) and may be involved in some intra-Golgi transport. Cargo normally passes through the ER-Golgi intermediate complex (ERGIC) compartment to the GA. (Courtesy of E Degen.)

protein, which, when bound, stimulates release of ADP with replacement by ATP. The ATP-chaperone complex, in turn, releases segments of the protein that have folded properly, and the cycle involving ADP and ATP binding is repeated until the protein is released. Chaperones are required for the correct targeting of proteins to their subcellular locations. A number of important properties of these proteins are listed in **Table 49–2**.

Chaperonins are the second major class of chaperones. They form complex **barrel-like structures** in which an unfolded protein is sequestered away from other proteins, giving it time and suitable conditions in which to fold properly. The structure of the bacterial chaperonin **GroEL** has been studied in detail. It is polymeric, has two ring-like structures, each composed of seven identical subunits, and again ATP is

TABLE 49–2 Some Properties of Chaperone Proteins

• Present in a wide range of species from bacteria to humans
• Many are so-called heat shock proteins (Hsp)
• Some are inducible by conditions that cause unfolding of newly synthesized proteins (eg, elevated temperature and various chemicals)
• They bind to predominantly hydrophobic regions of unfolded proteins and prevent their aggregation
• They act in part as a quality control or editing mechanism for detecting misfolded or otherwise defective proteins
• Most chaperones show associated ATPase activity, with ATP or ADP being involved in the protein-chaperone interaction
• Found in various cellular compartments such as cytosol, mitochondria, and the lumen of the endoplasmic reticulum

involved in its action. The heat shock protein **Hsp60** is the equivalent of GroEL in eukaryotes.

THE CYTOSOLIC PROTEIN SORTING BRANCH DIRECTS PROTEINS TO SUBCELLULAR ORGANELLES

Proteins synthesized via the cytosolic sorting branch either contain an uptake signal, enabling them to be taken up into the correct subcellular organelle, or, if they are destined for the cytosol, they have no targeting signal. Specific uptake signals direct proteins to the mitochondria, nucleus, and peroxisomes (Table 49–1). Since protein synthesis is complete before transport occurs, these processes are termed posttranslational translocation. The mechanisms involved will now be considered in turn.

Most mitochondrial proteins are imported

Mitochondria contains many proteins. Thirteen polypeptides (mostly membrane components of the electron transport chain) are encoded by the **mitochondrial (mt) genome** and synthesized in that organelle using its own protein-synthesizing system. However, the vast majority (at least several hundreds) are encoded by **nuclear genes**, are synthesized outside the mitochondria on **cytosolic polyribosomes**, and must be imported. **Yeast cells** have proved to be a particularly useful system for analyzing the mechanisms of import of mitochondrial proteins, partly because it has proved possible to generate a variety of **mutants** that have illuminated the fundamental processes involved. Most progress has been made in the study of proteins present in **the mitochondrial matrix**, such as the F_1 ATPase subunits. Only the pathway of import of matrix proteins will be discussed in any detail here.

Matrix proteins must pass from cytosolic polyribosomes through the **outer and inner mitochondrial membranes** to reach their destination. Passage through the two membranes is called **translocation**. They have an amino terminal leader sequence (**presequence**), about 20 to 50 amino acids in length (see Table 49–1), which is not highly conserved but is amphipathic and contains many hydrophobic and positively charged amino acids (eg, Lys or Arg). The presequence is equivalent to a signal peptide mediating attachment of polyribosomes to membranes of the ER (see below), but in this instance **targeting proteins to the matrix**. Some general features of the passage of a protein from the cytosol to the mt matrix are shown in **Figure 49–3**.

Translocation occurs **posttranslationally**, after the matrix proteins are released from the cytosolic polyribosomes. Interactions with a number of cytosolic proteins that act as **chaperones** (see below) and as **targeting factors** occur prior to translocation.

Two distinct **translocation complexes** are situated in the outer and inner mitochondrial membranes, referred to (respectively) as TOM (translocase-of-the-outer membrane) and TIM (translocase-of-the-inner membrane). Each complex

has been analyzed and found to be composed of a number of proteins, some of which act as **receptors** (eg, **Tom20/22**) for the incoming proteins and others as **components** (eg, **Tom40**) of the **transmembrane pores** through which these proteins must pass. Proteins must be in the **unfolded state** to pass through the complexes, and this is made possible by **ATP-dependent binding to several chaperone proteins** including **Hsp70** (Figure 49–3). In mitochondria, chaperones are involved in translocation, sorting, folding, assembly, and degradation of imported proteins. A **proton-motive force** across the inner membrane is required for import; it is made up of the **electric potential** across the membrane (inside negative) and the **pH gradient** (see Chapter 13). The positively charged leader sequence may be helped through the membrane by the negative charge in the matrix. The presequence is split off in the matrix by a **matrix-processing protease (MPP)**. Contact with **other chaperones** present in the matrix is essential to complete the overall process of import. Interaction with mt-Hsp70 (mt = mitochondrial; Hsp = heat shock protein; 70 = ~70 kDa) ensures proper import into the matrix and prevents misfolding or aggregation, while interaction with the mt-Hsp60–Hsp10 system ensures proper folding. The interactions of imported proteins with the above chaperones require **hydrolysis of ATP** to drive them.

The details of how preproteins are translocated have not been fully elucidated. It is possible that the electric potential associated with the inner mitochondrial membrane causes a conformational change in the unfolded preprotein being translocated and that this helps to pull it across. Furthermore, the fact that the matrix is more negative than the intermembrane space may “attract” the positively charged amino terminal of the preprotein to enter the matrix. Close apposition at **contact sites** between the outer and inner membranes is necessary for translocation to occur.

The above describes the major pathway of proteins destined for the mitochondrial matrix. However, certain proteins insert into the **outer mitochondrial membrane** facilitated by the TOM complex. Others stop in the **intermembrane space**, and some insert into the **inner membrane**. Yet others proceed into the matrix and then return to the inner membrane or intermembrane space. A number of proteins contain two signaling sequences—one to enter the mitochondrial matrix and the other to mediate subsequent relocation (eg, into the inner membrane). Certain mitochondrial proteins do not contain presequences (eg, cytochrome *c*, which locates in the intermembrane space), and others contain **internal presequences**. Overall, proteins employ a variety of mechanisms and routes to attain their final destinations in mitochondria.

General features that apply to the import of proteins into organelles, including mitochondria and some of the other organelles to be discussed below, are summarized in **Table 49–3**.

Transport of Macromolecules in & out of the Nucleus Involves Localization Signals

It has been estimated that more than a million macromolecules per minute are transported between the nucleus and the cytoplasm in an active eukaryotic cell. These macromolecules

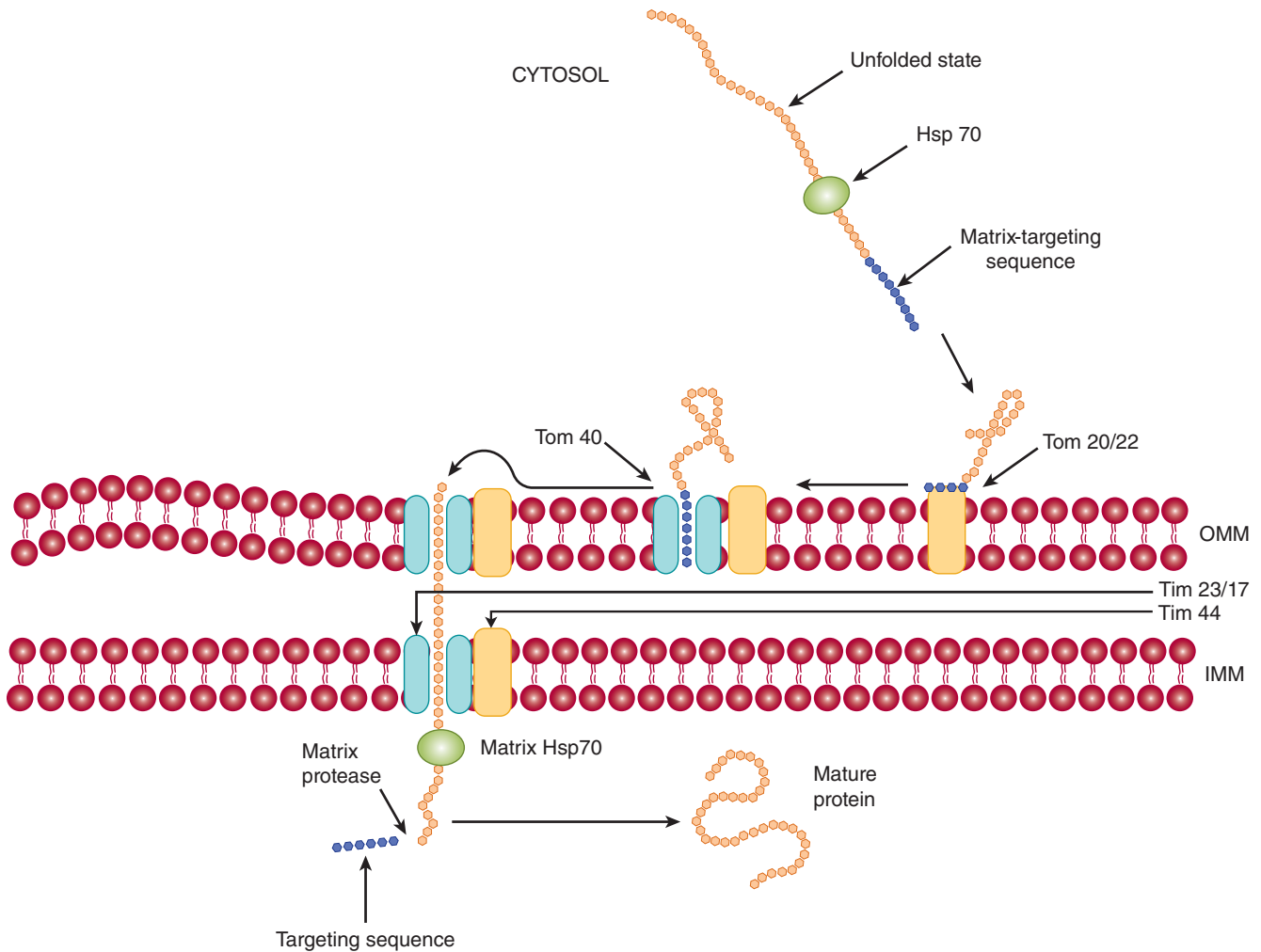

FIGURE 49-3 Entry of a protein into the mitochondrial matrix. The unfolded protein synthesized on cytosolic polyribosomes and containing a matrix-targeting sequence interacts with the cytosolic chaperone Hsp70 then interacts with the mt outer membrane receptor translocon of the outer membrane (Tom) 20/22, and is transferred to the import channel Tom 40. Translocation across the channel is followed by transport across the inner mt membrane via a complex comprising Tim (translocon of the inner membrane) 23 and Tim 17 proteins. On the inside of the inner mt membrane, it interacts with the matrix chaperone Hsp 70, which in turn interacts with membrane protein Tim 44. The hydrolysis of ATP by mt Hsp70 probably helps drive the translocation, as does the electronegative interior of the matrix. The targeting sequence is subsequently cleaved by the matrix protease, and the imported protein assumes its final shape, or may interact with an mt chaperonin prior to this. At the site of translocation, the outer and inner mt membranes are in close contact. OMM, outer mitochondrial membrane; IMM, inner mitochondrial membrane. (Modified, with permission, from Lodish H, et al: *Molecular Cell Biology*, 6th ed. W.H. Freeman & Co, 2008.)

TABLE 49-3 Some General Features of Protein Import to Organelles

<ul style="list-style-type: none"> • Import of a protein into an organelle usually occurs in three stages: recognition, translocation, and maturation.
<ul style="list-style-type: none"> • Targeting sequences on the protein are recognized in the cytoplasm or on the surface of the organelle.
<ul style="list-style-type: none"> • The protein is generally unfolded for translocation, a state maintained in the cytoplasm by chaperones.
<ul style="list-style-type: none"> • Threading of the protein through a membrane requires energy and organellar chaperones on the <i>trans</i> side of the membrane.
<ul style="list-style-type: none"> • Cycles of binding and release of the protein to the chaperone result in pulling of its polypeptide chain through the membrane.
<ul style="list-style-type: none"> • Other proteins within the organelle catalyze folding of the protein, often attaching cofactors or oligosaccharides and assembling them into active monomers or oligomers.

Source: Data from McNew JA, Goodman JM: The targeting and assembly of peroxisomal proteins: some old rules do not apply. *Trends Biochem Sci* 1998;21:54. Reprinted, with permission, from Elsevier.

include histones, ribosomal proteins and ribosomal subunits, transcription factors, and mRNA molecules. The transport is bidirectional and occurs through the **nuclear pore complexes** (NPCs). These are complex structures with a mass approximately 15 times that of a ribosome and are composed of aggregates of about 30 different proteins. The minimal diameter of an NPC is approximately 9 nm. Molecules smaller than about 40 kDa can pass through the channel of the NPC by **diffusion**, but **special translocation mechanisms** exist for larger molecules. These mechanisms are under intensive investigation, but some important features have already emerged.

Here we shall mainly describe **nuclear import** of certain macromolecules. The general picture that has emerged is that proteins to be imported (cargo molecules) carry a **nuclear localization signal (NLS)**. One example of an NLS is the amino

acid sequence (Pro)₂-(Lys)₃-Arg-Lys-Val (Table 49–1), which is markedly rich in basic residues. Depending on which NLS it contains, a cargo molecule interacts with one of a family of soluble proteins called **importins**, and the complex **docks** transiently at the NPC. Another family of proteins called **Ran** plays a critical regulatory role in the interaction of the complex with the NPC and in its translocation through the NPC. Ran proteins are small monomeric nuclear **GTPases** and, like other GTPases, exist in either GTP-bound or GDP-bound states. They are themselves regulated by **guanine nucleotide exchange factors (GEFs)**, which are located in the nucleus, and **Ran GTPase-accelerating proteins (GAPs)**, which are predominantly cytoplasmic. The GTP-bound state of Ran is favored in the nucleus and the GDP-bound state in the cytoplasm. The conformations and activities of Ran molecules vary depending on whether GTP or GDP is bound to them (the GTP-bound state is active; see discussion of G proteins in Chapter 42). The **asymmetry** between nucleus and

cytoplasm—with respect to which of these two nucleotides is bound to Ran molecules—is thought to be crucial in understanding the roles of Ran in transferring complexes unidirectionally across the NPC. When **cargo molecules are released inside the nucleus, the importins recirculate to the cytoplasm** to be used again. **Figure 49–4** summarizes some of the principal features in the above process.

Proteins similar to importins, referred to as **exportins**, are involved in the export of many macromolecules (various proteins, tRNA molecules, ribosomal subunits and certain mRNA molecules) from the nucleus. Cargo molecules for export carry **nuclear export signals (NESs)**. Ran proteins are involved in this process also, and it is now established that the processes of import and export share a number of common features. The family of importins and exportins are referred to as **karyopherins**.

Another system is involved in the translocation of the majority of **mRNA molecules**. These are exported from the

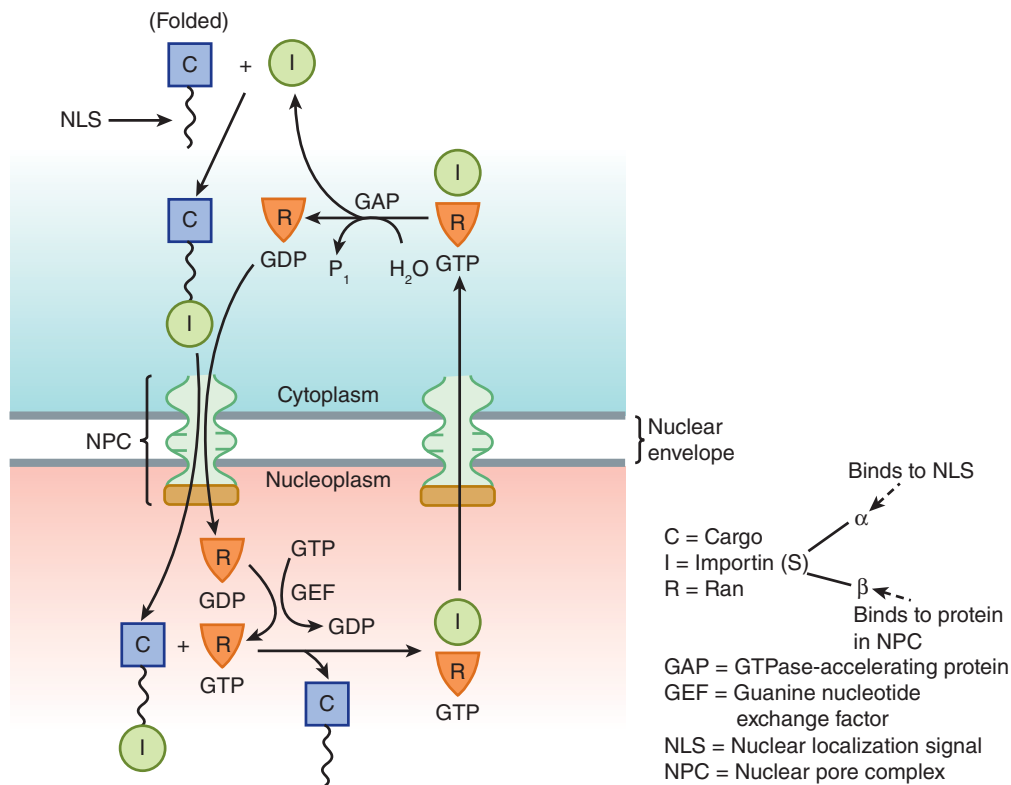

FIGURE 49–4 Simplified representation of the entry of a protein into the nucleoplasm.

A cargo molecule (C) in the cytoplasm interacts via its nuclear localization signal (NLS) to form a complex with an importin (I). (This may be either importin α or both importin α and importin β .) This complex interacts with Ran (R)-GDP and traverses the nuclear pore complex (NPC) into the nucleoplasm. In the nucleoplasm, Ran-GDP is converted to Ran-GTP by guanine nucleotide exchange factor (GEF), causing a conformational change in Ran which releases the cargo molecule. The I-Ran-GTP complex then leaves the nucleoplasm via the NPC to return to the cytoplasm. Here I is released to participate in another import cycle, due to the action of GTPase-accelerating protein (GAP), which converts GTP to GDP. The Ran-GTP is the active form of the complex, with the Ran-GDP form being inactive. Directionality is believed to be conferred on the overall process by the dissociation of Ran-GTP in the cytoplasm. (Modified, with permission, from Lodish H, et al: *Molecular Cell Biology*, 6th ed. W.H. Freeman & Co, 2008.)

nucleus to the cytoplasm as ribonucleoprotein (RNP) complexes attached to a protein named **mRNP exporter**. This is a heterodimeric molecule (ie, composed of two different subunits, TAP [also called Nfx1] and Nxt-1) that carries RNP molecules through the NPC. Ran is not involved. This system appears to use the hydrolysis of ATP by an RNA helicase (Dbp5) to drive translocation.

Other **small monomeric GTPases** (eg, ARF, Rab, Ras, and Rho) are important in various cellular processes such as vesicle formation and transport (ARF and Rab; see below), certain growth and differentiation processes (Ras), and formation of the actin cytoskeleton (Rho). A process involving GTP and GDP is also crucial in the transport of proteins across the membrane of the ER (see below).

Proteins Imported into Peroxisomes Carry Unique Targeting Sequences

The **peroxisome** is an important organelle involved in aspects of the metabolism of many molecules, including fatty acids

and other lipids (eg, plasmalogens, cholesterol, bile acids), purines, amino acids, and hydrogen peroxide. The peroxisome is bounded by a single membrane and contains more than 50 enzymes; catalase and urate oxidase are marker enzymes for this organelle. Its proteins are **synthesized on cytosolic polyribosomes** and fold prior to import. The pathways of import of a number of its proteins and enzymes have been studied, some being **matrix components** (Figure 49–5) and others **membrane components**. At least two **peroxisomal–matrix targeting sequences (PTSs)** have been discovered. One, **PTS1**, is a tripeptide (ie, Ser-Lys-Leu [SKL]), but variations of this sequence have been detected) located at the carboxyl terminal of a number of matrix proteins, including catalase. Another, **PTS2**, is a nine amino acid sequence the N-terminus and has been found in at least four matrix proteins (eg, thiolase). Neither of these two sequences is cleaved after entry into the matrix. Proteins containing PTS1 sequences **form complexes** with a cytosolic receptor protein (**Pex5**) and proteins containing PTS2 sequences complex with another receptor protein (**Pex7**). The resulting complexes then interact with a

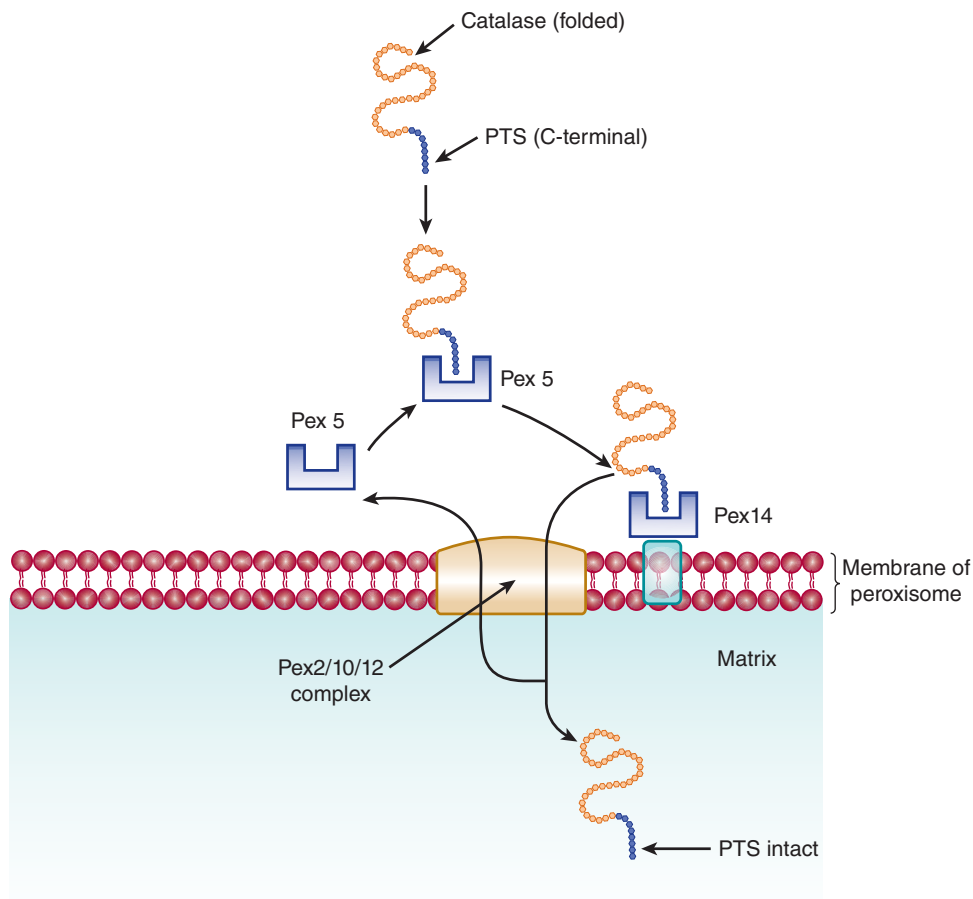

FIGURE 49–5 Entry of a protein into the peroxisomal matrix. The protein for import into the matrix is synthesized on cytosolic polyribosomes, assumes its folded shape prior to import, and contains a C-terminal peroxisomal-targeting sequence (PTS). It interacts with cytosolic receptor protein Pex5, and the complex then interacts with a receptor on the peroxisomal membrane, Pex14. In turn, the protein-Pex 14 complex passes to the Pex 2/10/12 complex on the peroxisomal membrane and is translocated. Pex 5 is returned to the cytosol. The protein retains its PTS in the matrix. (Modified, with permission, from Lodish H, et al: *Molecular Cell Biology*, 6th ed. W.H. Freeman & Co, 2008.)

membrane receptor complex, **Pex2/10/12**, which translocates them into the matrix. Proteins involved in further transport of proteins into the matrix are also present. Pex5 is recycled to the cytosol. Most **peroxisomal membrane proteins** have been found to contain neither of the above two targeting sequences, but seem to contain others. The import system can handle **intact oligomers** (eg, tetrameric catalase). Import of **matrix proteins** requires ATP, whereas import of **membrane proteins** does not.

Most Cases of Zellweger Syndrome Are due to Mutations in Genes Involved in the Biogenesis of Peroxisomes

Interest in import of proteins into peroxisomes has been stimulated by studies on **Zellweger syndrome**. This condition is apparent at birth and is characterized by **profound neurologic impairment**, victims often dying within a year. The number of peroxisomes can vary from being almost normal to being virtually absent in some patients. Biochemical findings include an accumulation of very-long-chain fatty acids, abnormalities of the synthesis of bile acids, and a marked reduction of plasmalogens. The condition is usually caused by **mutations** in genes encoding certain proteins—the PEX family of genes, also called **peroxins**—involved in various steps of **peroxisome biogenesis** (such as the import of proteins described above), or in genes encoding certain peroxisomal enzymes themselves. Two closely related conditions are **neonatal adrenoleukodystrophy** and **infantile Refsum disease**. Zellweger syndrome and these two conditions represent a **spectrum** of overlapping features, with Zellweger syndrome being the **most severe** (many proteins affected) and infantile Refsum disease the least severe (only one or a few proteins affected). **Table 49-4** lists these and related conditions.

TABLE 49-4 Disorders due to Peroxisomal Abnormalities

	OMIM Number ^a
Zellweger syndrome	214100
Neonatal adrenoleukodystrophy	202370
Infantile Refsum disease	266510
Hyperpipecolic acidemia	239400
Rhizomelic chondrodysplasia punctata	215100
Adrenoleukodystrophy	300100
Pseudoneonatal adrenoleukodystrophy	264470
Pseudo-Zellweger syndrome	261515
Hyperoxaluria type 1	259900
Acatlasemia	115500
Glutaryl-CoA oxidase deficiency	231690

^aOMIM, *Online Mendelian Inheritance in Man*. Each number specifies a reference in which information regarding each of the above conditions can be found.

Source : Reproduced, with permission, from Seashore MR, Wappner RS: *Genetics in Primary Care & Clinical Medicine*. Appleton & Lange, 1996.

PROTEINS SORTED VIA THE ROUGH ER BRANCH HAVE N-TERMINAL SIGNAL PEPTIDES

As indicated above, the **rough ER branch** is the second of the two branches involved in the synthesis and sorting of proteins. In this branch, proteins have **N-terminal signal peptides** and are synthesized on **membrane-bound polyribosomes**. They are usually **translocated into the lumen** of the rough ER prior to further sorting (Figure 49-2). Certain membrane proteins, however, are transferred directly into the membrane of the ER without reaching its lumen.

Some characteristics of N-terminal signal peptides are summarized in **Table 49-5**.

There is much **evidence to support** the signal hypothesis, confirming that N-terminal signal peptides are involved in the process of protein translocation across the ER membrane. For example, mutant proteins containing altered signal peptides in which hydrophobic amino acids are replaced by hydrophilic ones are not inserted into the lumen of the ER. On the other hand, nonmembrane proteins (eg, α -globin) to which signal peptides have been attached by genetic engineering can be inserted into the lumen of the ER, or even secreted.

Translocation of proteins to the ER may be Co-translational or Posttranslational

Most nascent proteins are transferred across the ER membrane into the lumen by the **cotranslational pathway**, so called because the process occurs during ongoing protein synthesis. The process of elongation of the remaining portion of the protein being synthesized probably facilitates passage of the nascent protein across the lipid bilayer. It is important that proteins be kept in an **unfolded state** prior to entering the conducting channel—otherwise, they may not be able to gain access to the channel. The pathway involves a number of specialized proteins and proceeds in 5 steps summarized below and in **Figure 49-6**.

Step 1: The signal sequence emerges from the ribosome and binds to the **signal recognition particle (SRP)**. The signal recognition particle (SRP) contains **six proteins** associated with an RNA molecule associated with it. Both the RNA molecule and its proteins play various roles (such as binding other molecules) in its function. This step temporarily arrests

TABLE 49-5 Some Properties of Signal Peptides Directing Proteins to the ER

• Usually, but not always, located at the amino terminal
• Contain approximately 12-35 amino acids
• Methionine is usually the amino terminal amino acid
• Contain a central cluster (-6-12) of hydrophobic amino acids
• The region near the N-terminus usually carries a net positive charge
• The amino acid residue at the cleavage site is variable, but residues -1 and -3 relative to the cleavage site must be small and neutral

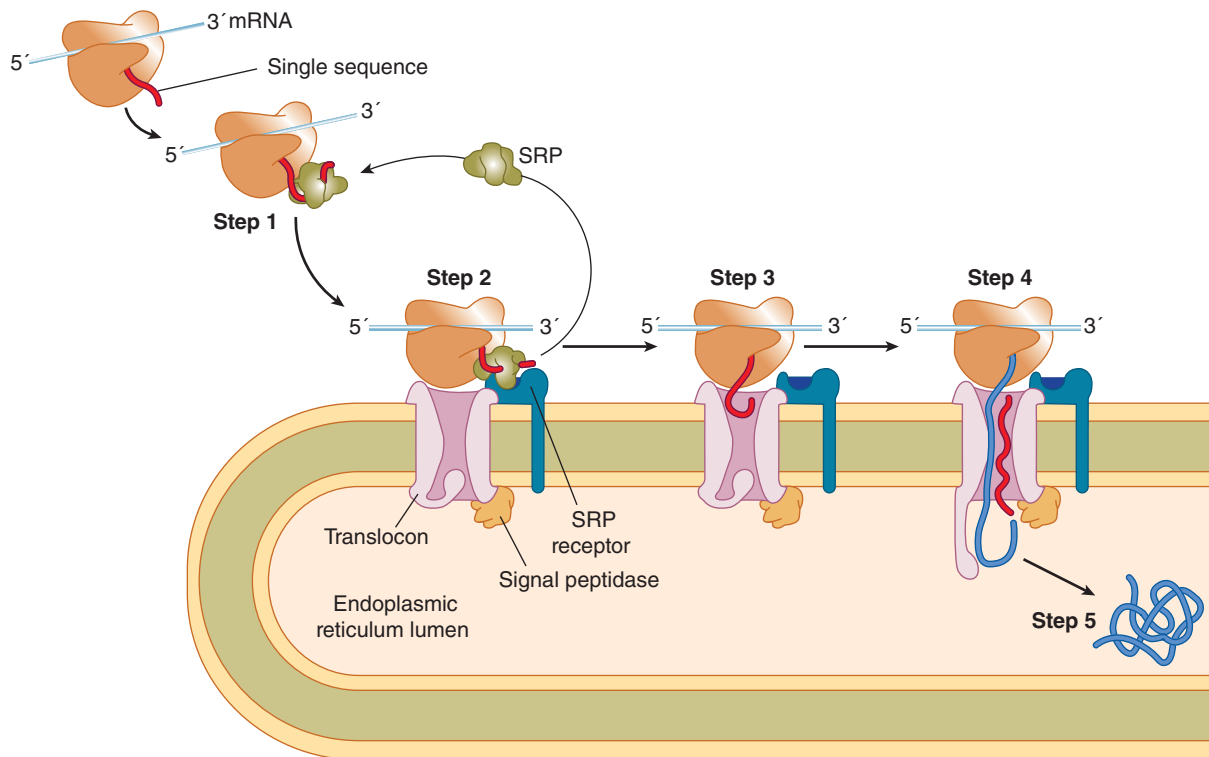

FIGURE 49-6 Cotranslational targeting of secretory proteins to the ER. **Step 1:** As the signal sequence emerges from the ribosome, it is recognized and bound by the signal recognition particle (SRP). **Step 2:** The SRP escorts the complex to the ER membrane where it binds to the SRP receptor (SR). **Step 3:** The SRP is released, the ribosome binds to the translocon, and the signal sequence is inserted into the membrane channel. **Step 4:** The signal sequence opens the translocon. Translation resumes and the growing polypeptide chain is translocated across the membrane. **Step 5:** Cleavage of the signal sequence by signal peptidase releases the polypeptide into the lumen of the ER. (Reproduced, with permission, from Cooper GM, Hausman RE: *The Cell: A Molecular Approach*. Sinauer Associates, Inc, 2009.)

further elongation of the polypeptide chain (elongation arrest) after some 70 amino acids have been polymerized.

Step 2: The SRP-ribosome-nascent protein complex travels to the ER membrane, where it binds to the **SRP receptor (SRP-R)**, an ER membrane protein composed of α and β subunits, the latter spanning the ER membrane. The SRP guides the complex to the SRP-R, which prevents premature expulsion of the growing polypeptide into the cytosol.

Step 3: The SRP is released, translation resumes, the ribosome binds to the **translocon (Sec 61 complex)**, and the signal peptide inserts into the channel in the translocon. SRP and both subunits of the SRP-R can bind **GTP** which must be in the GTP form in both complexes to enable them to interact. When interaction occurs, GTP is hydrolyzed, SRP dissociates from SRP-R and is released, and the ribosome binds to the translocon, allowing the signal peptide to enter it.

Step 4: The signal peptide induces opening of the channel in the translocon by binding to certain hydrophobic residues in it, thus causing the plug (shown at the bottom on the translocon in Figure 49-6) to move. The growing polypeptide is then fully translocated across the membrane, driven by its ongoing synthesis. The **translocon** consists of three membrane proteins (the Sec61 complex) that form a **protein-conducting channel** in the ER membrane through which the newly synthesized

protein may pass. The channel **opens only when a signal peptide is present**, preserving conductance across the ER membrane when it closes. Closure of the channel when proteins are not being translocated prevents ions such as calcium and other molecules leaking through it, and causing cell dysfunction.

Step 5: Cleavage of the signal peptide by **signal peptidase** occurs, and the fully translocated polypeptide/protein is released into the lumen of the ER. The signal peptide is presumably degraded by proteases. Ribosomes are released from the ER membrane and dissociate into their two types of subunits.

Secretory proteins and **soluble proteins destined for organelles distal to the ER** completely traverse the membrane bilayer and are discharged into the lumen of the ER. Many secretory proteins are N-glycosylated. **N-Glycan chains**, if present, are added by the enzyme **oligosaccharide:protein transferase** (see Chapter 46) as these proteins traverse the inner part of the ER membrane—a process called **cotranslational glycosylation**. Subsequently, these glycoproteins are found in the **lumen of the Golgi apparatus**, where further changes in glycan chains occur (Chapter 46) prior to intracellular distribution or secretion.

In contrast, proteins embedded in **membranes of the ER** as well as in **other membranes** along the secretory pathway only **partially translocate** across the ER membrane (steps 1-4, above).

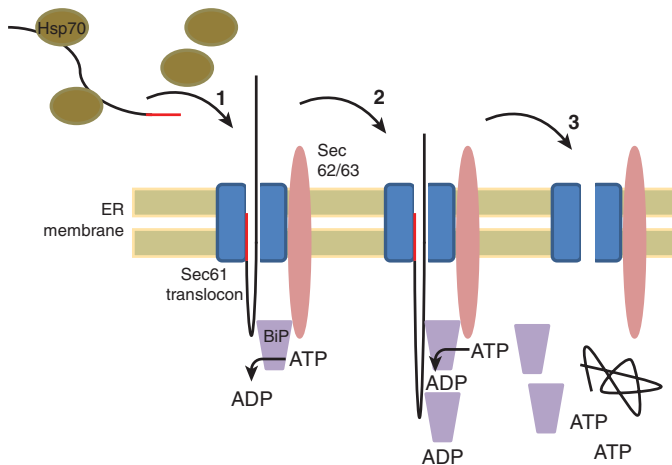

FIGURE 49-7 Posttranslational translocation of proteins into the ER. 1. Proteins synthesized in the cytosol are prevented from folding by chaperone proteins such as members of the Hsp70 family. The N-terminal signal sequence inserts into the Sec61 translocon complex and the cytosolic chaperones are released. BiP interacts with the protein and the Sec62/63 complex and its bound ATP is hydrolyzed to ADP. 2. The protein is prevented from moving back into the cytosol by the bound BiP and successive binding of BiP and ATP hydrolysis pulls the protein into the lumen. 3. When the whole protein is inside, ADP is exchanged for ATP and BiP is released.

They are able to insert into the ER membrane by lateral transfer through the wall of the translocon (see below).

Posttranslational translocation of proteins to the ER does occur in eukaryotes, although it is less common than the cotranslational route. The process (Figure 49-7) involves the Sec61 translocon complex, the **Sec62/Sec63 complex** which is also membrane bound, and chaperone proteins of the Hsp70 family. Some of these prevent the protein folding in the cytosol, but one of them, **binding immunoglobulin protein (BiP)**, is inside the ER lumen. The protein to be translocated initially binds to the translocon, and cytosolic chaperones are released. The leading end of the peptide then binds to BiP in the lumen. ATP bound to BiP interacts with Sec62/63, ATP is hydrolyzed to ADP providing energy to move the protein forwards, while the bound BiP-ADP prevents its moving backwards into the cytosol. It can then be pulled through by sequential binding of BiP molecules and ATP hydrolysis. When the entire protein has entered to lumen, ADP is exchanged for ATP, allowing BiP to be released. In addition to its function in protein sorting to the ER lumen, BiP **promotes proper folding by preventing aggregation** and will temporarily bind abnormally folded immunoglobulin heavy chains and many other proteins, preventing them from leaving the ER.

There is evidence that the ER membrane is involved in **retrograde transport** of various molecules from the ER lumen to the cytosol. These molecules include unfolded or misfolded glycoproteins, glycopeptides, and oligosaccharides. At least some of these molecules are **degraded in proteasomes** (see below). The involvement of the translocon in retrotranslocation is not clear; one or more other channels may be involved. Whatever the case, there is **two-way traffic** across the ER membrane.

THE PROTEINS FOLLOW SEVERAL ROUTES TO BE INSERTED INTO OR ATTACHED TO THE MEMBRANES OF THE ENDOPLASMIC RETICULUM

The routes that proteins follow to be inserted into the membranes of the ER include cotranslational insertion; posttranslational insertion; retention in the GA followed by retrieval to the ER; and retrograde transport from the GA.

Cotranslational Insertion Requires Stop Transfer Sequences or Internal Insertion Sequences

Figure 49-8 shows a variety of ways in which proteins are distributed in membranes. In particular, the **amino termini** of certain proteins (eg, the LDL receptor) can be seen to be on the extracytoplasmic face, whereas for other proteins (eg, the asialoglycoprotein receptor) the **carboxyl termini** are on this face. These dispositions are explained by the initial biosynthetic events at the ER membrane. Proteins like the **LDL receptor** enter the ER membrane in a manner analogous to a secretory protein (Figure 49-6); they partly traverse the ER membrane, the signal peptide is cleaved, and their amino terminal protrudes into the lumen (see also Figure 49-14). However, this type of protein contains a highly hydrophobic segment which acts as a **halt- or stop-transfer signal** and causes its retention in the membrane (Figure 49-9). This sequence has its N-terminal end in the ER lumen and the C-terminal in the cytosol; the stop-transfer signal forms the single transmembrane segment of the protein and is its membrane-anchoring domain. The protein is believed to exit the translocon into the membrane by a lateral gate which opens and closes continuously allowing hydrophobic sequences to enter the lipid bilayer.

The small patch of ER membrane in which the newly synthesized LDL receptor is located subsequently buds off as a component of a transport vesicle which eventually fuses with the plasma membrane so that the C-terminal faces the cytosol and the N-terminal now faces the outside of the cell (Figure 49-14). In contrast, the **asialoglycoprotein receptor** lacks a cleavable N-terminal signal peptide, but possesses an **internal insertion sequence**, which inserts into the membrane but is not cleaved. This acts as an anchor, and its C-terminus is extruded through the membrane into the ER lumen. Cytochrome P450 is anchored in a similar way, but its N-terminal, rather than C-terminal, is extruded into the lumen. The more complex disposition of a **transmembrane transporter** (eg, for glucose) which may have cross the membrane up to 12 times, can be explained by the fact that alternating transmembrane α -helices act as uncleaved insertion sequences and as halt-transfer signals, respectively. Each pair of helical segments is inserted as a hairpin. Sequences that determine the structure of a protein in a membrane are

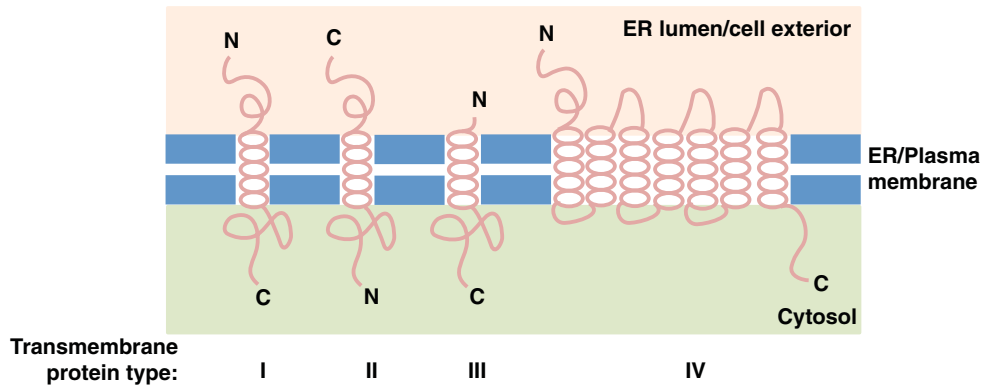

FIGURE 49-8 Variations in the way in which proteins are inserted into membranes. This schematic representation illustrates a number of possible orientations. The orientations form initially in the ER membrane, but are retained when vesicles bud off and fuse with the plasma membrane (see Figure 46-14), so that the terminal initially facing the ER lumen always faces the outside of the cell. Type I transmembrane proteins (eg, the LDL receptor and influenza hemagglutinin) cross the membrane once and have their amino termini in the ER lumen/cell exterior. Type II transmembrane proteins (eg, the asialoglycoprotein and transferrin receptors) also cross the membrane once, but have their C-termini in the ER lumen/cell exterior. Type III transmembrane proteins (eg, cytochrome P450, an ER membrane protein) have a disposition similar to type I proteins, but do not contain a cleavable signal peptide. Type IV transmembrane proteins (eg, G-protein-coupled receptors and glucose transporters) cross the membrane a number of times (7 times for the former and 12 times for the latter); they are also called polytopic membrane proteins. (C, carboxyl terminal; N, amino terminal.)

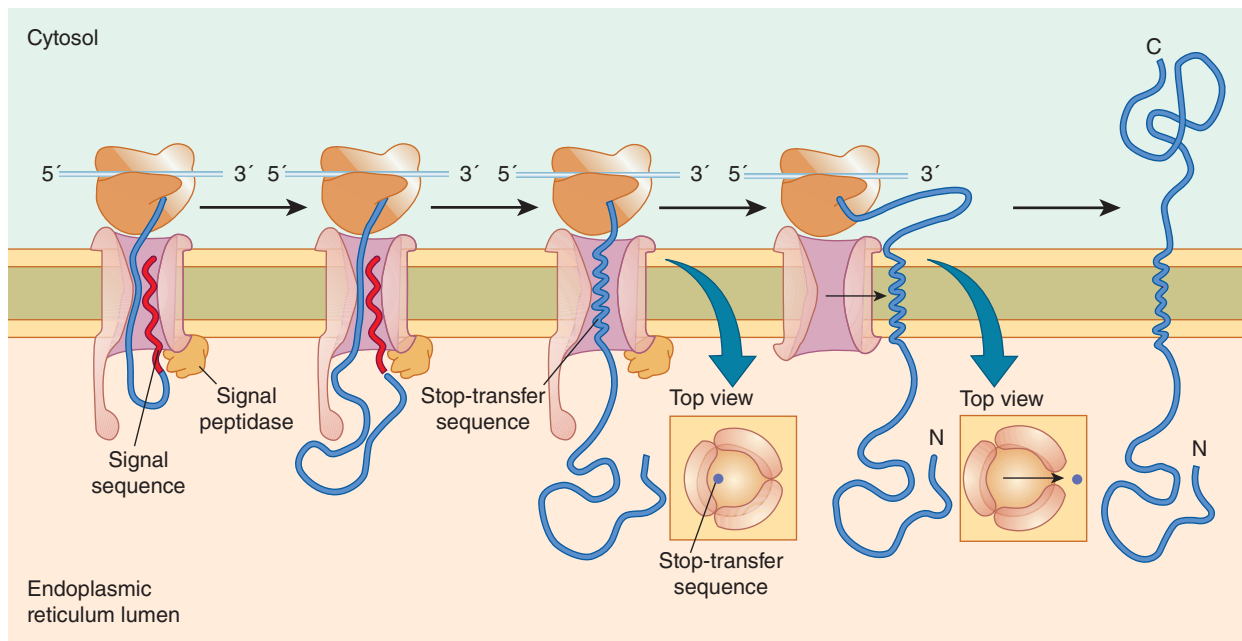

FIGURE 49-9 Insertion of a membrane protein with a cleavable signal sequence and a single stop-transfer sequence. The signal sequence is cleaved as the polypeptide chain crosses the membrane, so the amino terminus of the polypeptide chain is exposed in the ER lumen. However, translocation of the polypeptide chain across the membrane is halted when the translocon recognizes a transmembrane stop-transfer sequence. This allows the protein to exit the channel via a lateral gate and become anchored in the membrane. Continued translation results in a membrane-spanning protein with its carboxy terminus on the cytosolic side. (Reproduced with permission from Cooper GM, Hausman RE: *The Cell: A Molecular Approach*. Sinauer Associates, Inc, 2009.)

called **topogenic sequences**. The LDL receptor, asialoglycoprotein receptor, and glucose transporter are examples of type I, type II, and type IV transmembrane proteins and are found in the plasma membrane, while cytochrome P450 is an example of a type III protein which remains in the ER membrane (Figure 49–8).

Some Proteins Are Synthesized on Free Polyribosomes Attached to the Endoplasmic Reticulum Membrane Posttranslationally

Proteins may enter the ER membrane posttranslationally through the lateral gate in the translocon in a similar way to cotranslationally sorted molecules. An example is **cytochrome b_5** , which appears to enter the ER membrane subsequent to translation, assisted by several chaperones.

Other Routes Include Retention in the GA With Retrieval to the ER and Also Retrograde Transport From the GA

A number of proteins possess the amino acid sequence **KDEL** (Lys-Asp-Glu-Leu) at their carboxyl terminal (see Table 49–1). KDEL-containing proteins first travel to the **GA** in **vesicles coated with coat protein II (COPII)** (see below). This process is known as **anterograde vesicular transport**. In the GA they interact with a specific KDEL receptor protein, which retains them transiently. They then **return to the ER in vesicles coated with COPI (retrograde vesicular transport)**, where they dissociate from the receptor, and are thus retrieved. HDEL sequences (H = histidine) serve a similar purpose. The above processes result in net localization of certain soluble proteins to the ER lumen.

Certain other **non-KDEL-containing proteins** also pass to the Golgi and then return, by retrograde vesicular transport, to the ER to be inserted therein. These include vesicle components that must be recycled, as well as certain ER membrane proteins. These proteins often possess a C-terminal signal located in the cytosol rich in basic residues.

Thus, a **variety of routes** are involved in assembly of the proteins of the ER membranes and a similar situation probably holds for other membranes (eg, the mitochondrial membranes and the plasma membrane). Precise targeting sequences have been identified in some instances (eg, KDEL sequences).

The topic of membrane biogenesis is discussed further later in this chapter.

THE ER FUNCTIONS AS THE QUALITY CONTROL COMPARTMENT OF THE CELL

After entering the ER, newly synthesized proteins attempt to fold with the assistance of chaperones and folding enzymes, and their folding status is monitored by chaperones and also enzymes (Table 49–6).

TABLE 49–6 Some Chaperones and Enzymes Involved in Folding That Are Located in the Rough Endoplasmic Reticulum

• BiP (immunoglobulin heavy chain binding protein)
• GRP94 (glucose-regulated protein)
• Calnexin
• Calreticulin
• PDI (protein disulfide isomerase)
• PPI (peptidyl prolyl <i>cis-trans</i> isomerase)

The chaperone **calnexin** is a calcium-binding protein located in the ER membrane. This protein binds a wide variety of proteins, including major histocompatibility complex (MHC) antigens and a variety of plasma proteins. As described in Chapter 46, calnexin binds the monoglucosylated species of glycoproteins that occur during processing of glycoproteins, retaining them in the ER until the glycoprotein has folded properly. **Calreticulin**, which is also a calcium-binding protein, has properties similar to those of calnexin, but it is not membrane-bound. In addition to chaperones, two enzymes in the ER lumen are concerned with proper folding of proteins. **Protein disulfide isomerase (PDI)** promotes **rapid formation** and reshuffling of disulfide bonds until the correct set is achieved. **Peptidyl prolyl isomerase (PPI)** accelerates folding of proline-containing proteins by catalyzing the *cis-trans* isomerization of X-Pro bonds, where X is any amino acid residue.

Misfolded or incompletely folded proteins interact with chaperones, which retain them in the ER and prevent them from being exported to their final destinations. If such interactions continue for a prolonged period of time, the misfolded proteins are usually disposed of by **endoplasmic reticulum-associated degradation (ERAD)**. This avoids a harmful build-up of misfolded proteins. In a number of genetic diseases, such as cystic fibrosis, retention of misfolded proteins occurs in the ER, and in some cases, the retained proteins still exhibit some functional activity. As discussed later in this Chapter, there is much current interest in finding drugs that will interact with such proteins and promote their correct folding and export out of the ER.

MISFOLDED PROTEINS UNDERGO ENDOPLASMIC RETICULUM-ASSOCIATED DEGRADATION

Maintenance of **homeostasis in the ER** is important for normal cell function. Perturbation of the unique environment within the lumen of the ER (eg, by changes in ER Ca^{2+} , alterations of redox status, exposure to various toxins or some viruses), can lead to reduced protein folding capacity and the accumulation of misfolded proteins. The accumulation of

TABLE 49-7 Some Conformational Diseases That Are Caused by Abnormalities in Intracellular Transport of Specific Proteins and Enzymes due to Mutations^a

Disease	Affected Protein
α_1 -Antitrypsin deficiency with liver disease	α_1 -Antitrypsin
Chediak-Higashi syndrome	Lysosomal trafficking regulator
Combined deficiency of factors V and VIII	ERGIC53, a mannose-binding lectin
Cystic fibrosis	CFTR
Diabetes mellitus [some cases]	Insulin receptor (α -subunit)
Familial hypercholesterolemia, autosomal dominant	LDL receptor
Gaucher disease	β -Glucosidase
Hemophilia A and B	Factors VIII and IX
Hereditary hemochromatosis	HFE
Hermansky-Pudlak syndrome	AP-3 adaptor complex β 3A subunit
I-cell disease	<i>N</i> -acetylglucosamine 1-phosphotransferase
Lowe oculocerebrorenal syndrome	PIP ₂ 5-phosphatase
Tay-Sachs disease	β -Hexosaminidase
von Willebrand disease	von Willebrand factor

Abbreviation : PIP₂, phosphatidylinositol 4,5-bisphosphate.

^aSee Schroder M, Kaufman RJ: The mammalian unfolded protein response. *Annu Rev Biochem* 2005;74:739 and Olkonen V, Ikonen E: Genetic defects of intracellular membrane transport. *N Eng J Med* 2000;343:10095.

misfolded proteins in the ER is referred to as **ER stress**. The cell has evolved a mechanism termed the **unfolded protein response (UPR)** to sense the levels of misfolded proteins and initiate intracellular signaling mechanisms to compensate for the stress conditions and restore ER homeostasis. The UPR is initiated by **ER stress sensors**, which are transmembrane proteins embedded in the ER membrane. Activation of these stress sensors causes three principal effects: (1) transient inhibition of translation to reduce the amount of newly synthesized proteins, (2) induction of a transcription leading to increased expression of ER chaperones and to (3) increased synthesis of proteins involved in degradation of misfolded ER proteins (discussed below). Therefore, the UPR increases the ER folding capacity and prevents a buildup of unproductive and potentially toxic protein products, in addition to other responses to restore cellular homeostasis. However, if impairment of folding persists, cell death pathways (apoptosis) are activated. A more complete understanding of the UPR is likely to provide new approaches to treating diseases in which ER stress and defective protein folding occur (see Table 49-7).

Proteins that misfold in the ER degraded by the ERAD pathway (**Figure 49-10**). This occurs by selective transport of both luminal and membrane proteins **back across the ER (retrotranslocation or dislocation)** to enter **proteasomes**

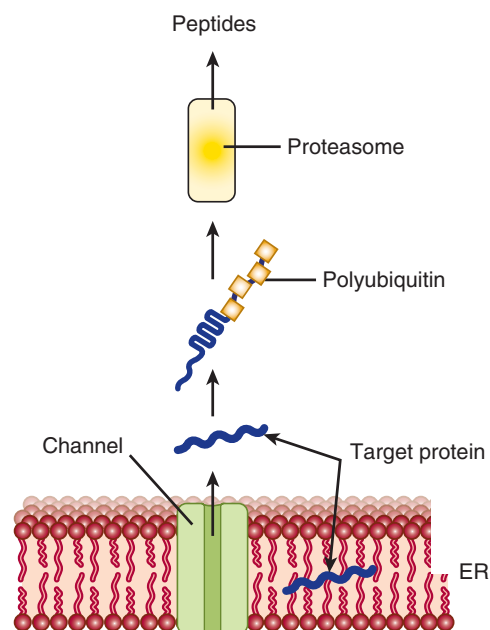
**FIGURE 49-10 Simplified scheme of the events in ERAD.**

A target protein which is misfolded undergoes retrograde transport through the ER membrane into the cytosol, where it is subjected to polyubiquitination. Following polyubiquitination, it enters a proteasome, inside which it is degraded to small peptides that exit and may have several fates. Liberated ubiquitin molecules are recycled. Several proteins, including Sec61, Derlin 1 and the ERAD E3 ligases, Hrd1 and Doa10, are potential ERAD channel candidates. However, there is no clear evidence to demonstrate that a channel exists and alternative mechanisms involving membrane perturbation have also been proposed.

present in the cytosol. The energy for translocation appears to be at least partly supplied by **p97**, an AAA-ATPase (one of a family of ATPases **Associated with various cellular Activities**), the precise route by which the misfolded proteins pass back across the ER membrane has not yet been established. A number of candidates have been suggested as possible transmembrane channels for ERAD. These include Sec61, the complex responsible for protein entry into the ER, **degradation in ER protein 1 (derlin1)**, and the **ERAD E3 ligases, Hrd1 and Doa10**. However, although it seems reasonable to assume that proteins must exit the ER via a membrane pore, there is, as yet, no definitive evidence that such a channel exists, and it is possible that a completely different mechanism is used. For example, it has been suggested that membrane perturbation processes similar to those leading to the formation of cytosolic lipid droplets, or caused by the action of **rhomboid proteins**, which regulate intermembrane proteolysis, may be involved.

Chaperones present in the lumen of the ER (eg, BiP) and in the cytosol help target misfolded proteins to proteasomes. Prior to entering proteasomes, most proteins are **ubiquitinated** (see the next paragraph) and are escorted to proteasomes by **polyubiquitin-binding proteins**. **Ubiquitin ligases** are present in the ER membrane.

Ubiquitin Is a Key Molecule in Protein Degradation

There are two major pathways of protein degradation in eukaryotes. One involves **lysosomal proteases** and does not require ATP, but the major pathway involves **ubiquitin** and is ATP-dependent. The ubiquitin pathway is particularly associated with **disposal of misfolded proteins and regulatory enzymes that have short half-lives**. Ubiquitin is known to be involved in diverse important physiologic processes including **cell-cycle regulation** (degradation of cyclins), **DNA repair, inflammation and the immune response** (see Chapter 52), **muscle wasting, viral infections, and many others**. Ubiquitin is a **small** (76 amino acids), **highly conserved protein** that plays a key role in **marking** various proteins for subsequent **degradation in proteasomes**. The mechanism of attachment of ubiquitin to a target protein (eg, a misfolded form of cystic fibrosis transmembrane conductance regulator [CFTR], the protein involved in the causation of cystic fibrosis; see Chapter 40) is shown in **Figure 49–12** and involves **three enzymes**: an **activating enzyme (E1)**, a **conjugating enzyme (E2)**, and a **ligase (E3)**. There are a number of types of conjugating enzymes, and, surprisingly, some hundreds of different ligases. It is the latter enzyme that confers substrate specificity. Once the molecule of ubiquitin is attached to the protein, a number of others are also attached, resulting in a **polyubiquitinated target protein**. It has been estimated that a **minimum of four ubiquitin molecules** must be attached to commit a target molecule to degradation in a proteasome. Ubiquitin can be **cleaved** from a target protein by deubiquitinating **enzymes** and the liberated ubiquitin can be reused.

Ubiquitinated Proteins Are Degraded in Proteasomes

Polyubiquitinated target proteins enter **proteasomes** located in the cytosol. Proteasomes are protein complexes with a

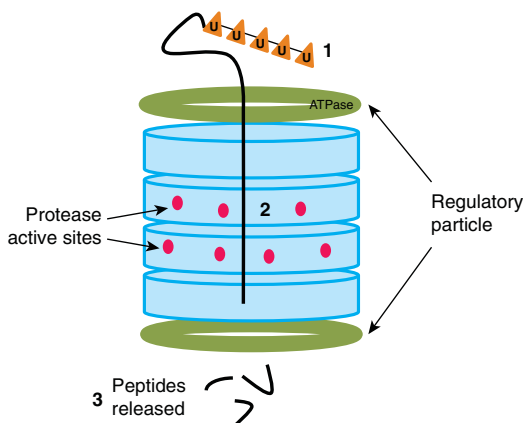

FIGURE 49–11 Protein degradation in the proteasome. 1. The regulatory particle recognizes the ubiquitinated protein which are unfolded by ATPases present in the regulatory particles or caps. 2. Protease active sites in the core of the proteasome attack peptide bonds and degrade the protein. 3. Peptides are released into the cytosol for further degradation by cytosolic peptidases.

relatively **large cylindrical structure** and are composed of four rings with a hollow **core** containing the protease active sites, and one or two **caps** or **regulatory particles** that recognize the polyubiquitinated substrates and initiate degradation (**Figure 49–11**). Target proteins are unfolded by ATPases present in the proteasome caps. Proteasomes can hydrolyze a very wide variety of peptide bonds. Target proteins pass into the core to be degraded to small peptides, which then exit the proteasome to be further degraded by cytosolic peptidases. Both normally and abnormally folded proteins are substrates for the proteasome. Liberated ubiquitin molecules are recycled. The proteasome plays an important role in **presenting small peptides** produced by **degradation of various viruses** and other molecules to **MHC class I molecules**, a key step in antigen presentation to T lymphocytes.

TRANSPORT VESICLES ARE KEY PLAYERS IN INTRACELLULAR PROTEIN TRAFFIC

Proteins that are synthesized on membrane-bound polyribosomes and are destined for the GA or PM reach these sites inside **transport vesicles**. As indicated in **Table 49–8**, there

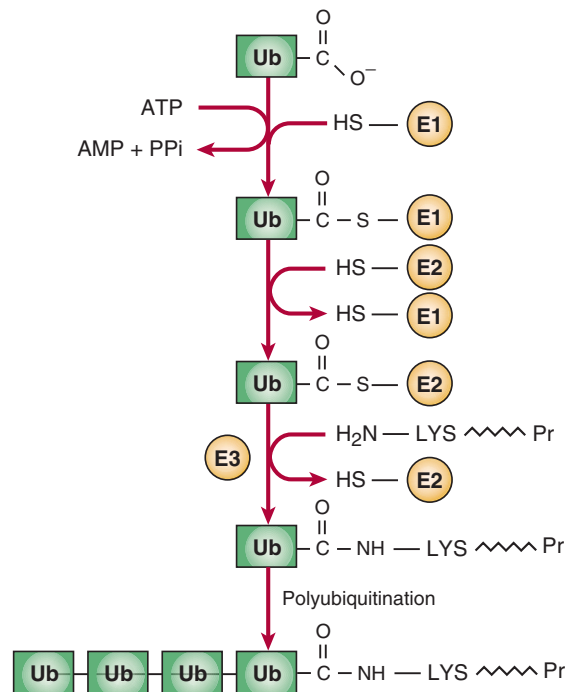

FIGURE 49–12 Sequence of reactions in addition of ubiquitin to a target protein. The C-terminal COO^- group of ubiquitin (Ub) is first linked in a thioester bond to an SH group of the activating enzyme (E1). The activated ubiquitin is transferred to an SH group of the conjugating enzyme. The transfer of ubiquitin from E2 to an ϵ -amino group on a lysine of the target protein is then catalysed by a ligase enzyme. Additional rounds of ubiquitination then build up the polyubiquitin chain. (LYS Pr, target protein.)

TABLE 49–8 Some Types of Vesicles and Their Functions

Vesicle	Function
COPI	Involved in intra-GA transport and retrograde transport from the GA to the ER
COPII	Involved in export from the ER to either ERGIC or the GA
Clathrin	Involved in transport in post-GA locations including the PM, TGN and endosomes
Secretory vesicles	Involved in regulated secretion from organs such as the pancreas (eg, secretion of insulin)
Vesicles from the TGN to the PM	They carry proteins to the PM and are also involved in constitutive secretion

Abbreviations: ER, endoplasmic reticulum; ERGIC, ER-GA intermediate compartment; GA, Golgi apparatus; PM, plasma membrane; TGN, *trans*-Golgi network.

Note: Each vesicle has its own set of coat proteins. Clathrin is associated with various adaptor proteins forming different types of clathrin vesicles which have different intracellular targets.

are a number of different types of vesicles. Other types of vesicles may remain to be discovered.

Each vesicle has its own set of coat proteins. **Clathrin** is used in vesicles destined for exocytosis (see discussions of the LDL receptor in Chapters 25 and 26), in some of those carrying cargo to lysosomes. This protein consists of three interlocking spirals, which interact to form a lattice around the vesicle. COPI and COPII, the vesicles involved in **retrograde transport** (from the GA to the ER) and **anterograde transport** (from the ER to the GA), respectively, however, are clathrin-free. Transport and secretory vesicles carrying cargo from the GA to the PM are also clathrin-free. Here we focus mainly on COPII, COPI, and clathrin-coated vesicles. Each type has a different complement of proteins in its coat. For the sake of clarity, the non-clathrin-coated vesicles are referred to in this text as **transport vesicles**. The principles concerning assembly of these different types are generally similar, although some details of assembly for COPI and clathrin-coated vesicles differ from those for COPII (see below).

Model of Transport Vesicles Involves SNAREs & Other Factors

Vesicles lie at the heart of intracellular transport of many proteins. The use by Schekman and colleagues of **genetic approaches for studying** vesicles in yeast and the development by Rothman and colleagues of **cell-free systems** to study vesicle formation have been crucial in the understanding of the events involved in vesicle formation and transport. For instance, it is possible to observe, by electron microscopy, budding of vesicles from Golgi preparations incubated with cytosol, ATP and GTP- γ . The overall mechanism is complex, and involves a variety of cytosolic and membrane proteins, GTP, ATP, and accessory factors. **Budding, tethering, docking,** and

membrane fusion are key steps in the life cycles of vesicles, with the GTP-binding proteins, **Sar1**, **ARF**, and **Rab** acting as **molecular switches**. Sar1 is the protein involved in step 1 of formation of COPII vesicles, whereas ARF is involved in the formation of COPI and clathrin-coated vesicles. The functions of the various proteins involved in vesicle processing and the abbreviations used are shown in **Table 49–9**.

There are common general steps in transport vesicle formation, vesicle targeting and fusion with a target membrane, irrespective of the membrane the vesicle forms from or its intracellular destination. The nature of the coat proteins, GTPases and targeting factors differ depending on where the vesicle forms from and its eventual destination. Anterograde transport from the ER to the Golgi involving COPII vesicles is the best studied example. The process can be considered to occur in eight steps (**Figure 49–13**). The basic concept is that each transport vesicle is loaded with specific cargo and also one or more **v-SNARE** proteins that direct targeting. Each target membrane bears one or more **complementary t-SNARE proteins** with which the former interact, mediating SNARE protein-dependent vesicle–membrane fusion. In addition, **Rab proteins** also help direct the vesicles to specific membranes and their tethering at a target membrane.

Step 1: Budding is initiated when **Sar1** is activated when GTP is bound in exchange for GDP via the action of **Sec12p** (Table 49–9), switching it from a soluble to a membrane bound form by causing a conformational change which exposes a hydrophobic tail. Thus it becomes embedded in the ER membrane to form a focal point for vesicle assembly.

Step 2: Various **coat proteins** bind to **Sar1-GTP**. In turn, membrane cargo proteins bind to the coat proteins either

TABLE 49–9 Some Factors Involved in the Formation of Non-Clathrin-Coated Vesicles and Their Transport

• ARF: ADP-ribosylation factor, a GTPase involved in formation of COPI and also clathrin-coated vesicles.
• Coat proteins: A family of proteins found in coated vesicles. Different transport vesicles have different complements of coat proteins.
• NSF: <i>N</i> -ethylmaleimide-sensitive factor, an ATPase.
• Sar1: A GTPase that plays a key role in assembly of COPII vesicles.
• Sec12p: A guanine nucleotide exchange factor (GEF) that interconverts Sar1-GDP and Sar1-GTP.
• α -SNAP: Soluble NSF attachment protein. Along with NSF, this protein is involved in dissociation of SNARE complexes.
• SNARE: SNAP receptor. SNAREs are key molecules in the fusion of vesicles with acceptor membranes.
• t-SNARE: Target SNARE.
• v-SNARE: Vesicle SNARE.
• Rab proteins: A family of Ras-related proteins (monomeric GTPases) first observed in rat brain. They are active when GTP is bound. Different Rab molecules dock different vesicles to acceptor membranes.
• Rab effector proteins: A family of proteins that interact with Rab molecules; some act to tether vesicles to acceptor membranes.

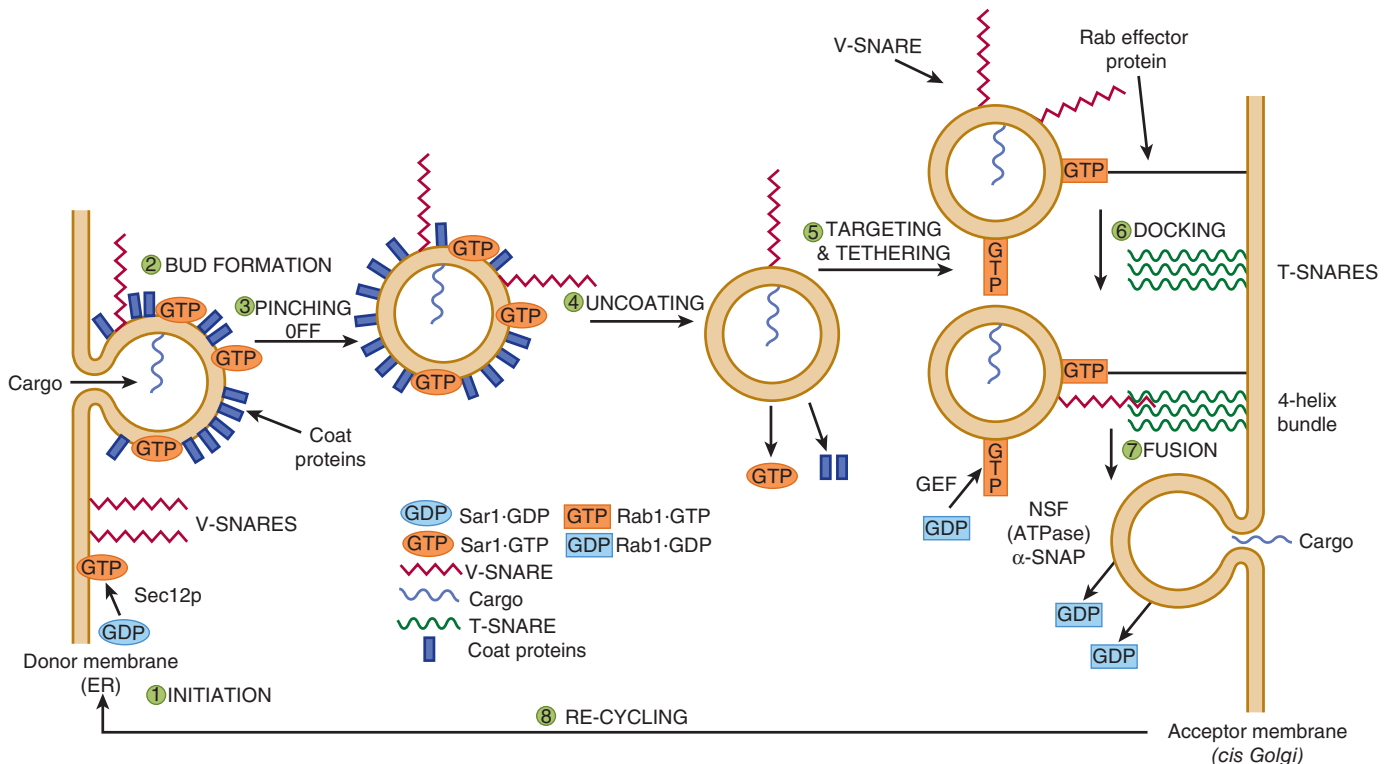

FIGURE 49-13 Model of the steps in a round of anterograde transport involving COPII vesicles. **Step 1:** Sar1 is activated when GDP is exchanged for GTP and it becomes embedded in the ER membrane to form a focal point for bud formation. **Step 2:** Coat proteins bind to Sar1-GTP and cargo proteins become enclosed inside the vesicles. **Step 3:** The bud pinches off, forming a complete coated vesicle. Vesicles move through cells along microtubules or actin filaments. **Step 4:** The vesicle is uncoated when bound GTP is hydrolyzed to GDP by Sar1. **Step 5:** Rab molecules are attached to vesicles after switching of Rab-GDP to Rab-GTP, a specific GEF (see Table 49-9). Rab effector proteins on target membranes bind to Rab-GTP, tethering the vesicles to the target membrane. **Step 6:** v-SNAREs pair with cognate t-SNAREs in the target membrane to form a four helix bundle which docks the vesicles and initiates fusion. **Step 7:** When the v- and t-SNAREs are closely aligned, the vesicle fuses with the membrane and the contents are released. GTP is then hydrolyzed to GDP, and the Rab-GDP molecules are released into the cytosol. An ATPase (NSF) and α -SNAP (see Table 49-9) dissociate the four-helix bundle between the v- and t-SNAREs so that they can be reused. **Step 8:** Rab and SNARE proteins are recycled for further rounds of vesicle fusion. (Adapted, with permission, from Rothman JE: Mechanisms of intracellular protein transport. Nature 1994;372:55.)

directly or via **intermediary proteins** that attach to coat proteins, and they then become enclosed in their appropriate vesicles. Soluble cargo proteins bind to receptor regions inside the vesicles. A number of **signal sequences** on cargo molecules have been identified (Table 49-1). For example KDEL sequences direct certain ER-resident proteins in retrograde flow to the ER in COPI vesicles. Di-acidic sequences (eg, Asp-X-Glu, X = any amino acid) and short hydrophobic sequences on membrane proteins are involved in interactions with coat proteins of COPII vesicles. Not all cargo molecules have a sorting signal. Some highly abundant secretory proteins travel to various cellular destinations in transport vesicles by **bulk flow**; that is, they enter into transport vesicles at the same concentration that they occur in the organelle. However, it appears that most proteins are actively sorted (concentrated) into transport vesicles and bulk flow is used by only a select group of cargo proteins. Additional coat proteins are assembled to **complete bud formation**. Coat proteins promote budding, contribute to the curvature of buds and also help sort proteins.

Step 3: The **bud pinches off**, completing formation of the coated vesicle. The curvature of the ER membrane and protein-protein and protein-lipid interactions in the bud facilitate pinching off from ER exit sites. Vesicles move through cells along **microtubules** or along **actin filaments**.

Step 4: **Coat disassembly** (involving **dissociation** of Sar1 and the **shell** of coat proteins) follows **hydrolysis of bound GTP to GDP** by Sar1, promoted by a specific coat protein. Sar1 thus plays key roles in both assembly and dissociation of the coat proteins. **GTP- γ -S** (a nonhydrolyzable analog of GTP often used in investigations of the role of GTP in biochemical processes) **blocks disassembly of the coat** from coated vesicles, leading to a build-up of coated vesicles, facilitating their study. **Uncoating** is necessary for fusion to occur.

Step 5: **Vesicle targeting** is achieved by attachment of **Rab** molecules to vesicles. Rabs are a family of Ras-like proteins required in several steps of intracellular protein transport and also in regulated secretion and endocytosis. They are **small monomeric GTPases** that attach to the cytosolic faces of budding

vesicles in the **GTP-bound state** and are also present on acceptor membranes. Rab-GDP molecules in the cytosol are switched to Rab-GTP molecules by a specific GEF (Table 49–9). **Rab effector proteins** on target membranes bind to Rab-GTP, but not Rab-GDP molecules, thus **tethering** the vesicles to the membranes.

Step 6: v-SNAREs pair with cognate t-SNAREs in the target membrane to **dock** the vesicles and initiate fusion. Generally, one v-SNARE in the vesicle pairs with three t-SNAREs on the acceptor membrane to form a tight **four-helix bundle**. In **synaptic vesicles** one v-SNARE is designated **synaptobrevin**. **Botulinum B toxin** is one of the most lethal toxins known and the most serious cause of food poisoning. One component of this toxin is a **protease** that binds **synaptobrevin**, thus **inhibiting release of acetylcholine** at the neuromuscular junction and possibly proving fatal.

Step 7: Fusion of the vesicle with the acceptor membrane occurs once the v- and t-SNAREs are closely aligned. After vesicle fusion and release of contents occurs, GTP is hydrolyzed to GDP, and the Rab-GDP molecules are released into the cytosol. When a SNARE on one membrane interacts with a SNARE on another membrane, linking the two, this is referred to as a **trans-SNARE complex** or a **SNARE pin**. Interactions of SNAREs on the same membrane form a **cis-SNARE complex**. In order to dissociate the four-helix bundle between the v- and t-SNAREs so that they can be reused, two additional proteins are required. These are an **ATPase (NSF)** and **α -SNAP** (see Table 49–9). NSF hydrolyzes ATP and the energy released dissociates the four-helix bundle making the SNARE proteins available for another round of membrane fusion.

Step 8: Certain components, such as the Rab and SNARE proteins, are **recycled** for subsequent rounds of vesicle fusion.

During the above cycle, SNAREs, tethering proteins, Rab, and other proteins all **collaborate** to deliver a vesicle and its contents to the appropriate site.

Some Transport Vesicles Travel via the Trans Golgi Network

Proteins in the **apical** or **basolateral** areas of the plasma membranes of polarized epithelial cells can be transported to these sites in **transport vesicles** budding from the **trans Golgi network**. Different Rab proteins likely direct some vesicles

to apical regions and others to basolateral regions. In certain cells, proteins are first directed to the basolateral membrane, then endocytosed and transported across the cell by **transcytosis** to the apical region. Yet another mechanism for sorting proteins to the apical region (or in some cases to the basolateral region) involves the **glycosylphosphatidylinositol (GPI) anchor** described in Chapter 46. This structure is also often present in **lipid rafts** (see Chapter 40).

Once proteins in the secretory pathway reach the *cis*-Golgi from the ER in vesicles, they can travel through the GA to the *trans*-Golgi in vesicles, or by a process called **cisternal maturation**, in which the cisternae move and transform into one another, or perhaps in some cases **diffusion** via intracisternal connections that have been observed in some cell types. In this model, vesicular elements from the ER fuse with one another to help form the *cis*-Golgi, which in turn can move forward to become the medial Golgi, etc. COPI vesicles return Golgi enzymes (eg, glycosyltransferases) back from distal cisternae of the GA to more proximal (eg, *cis*) cisternae.

The Formation of COPI Vesicles Is Inhibited by Brefeldin

The fungal metabolite **brefeldin A** prevents **GTP from binding to ARF**, and thus inhibits formation of COPI vesicles. In its presence, the Golgi apparatus appears to **collapse into the ER**. It may do this by inhibiting the GEF involved in formation of COPI vesicles. Brefeldin A has thus proven to be a useful tool for examining some aspects of Golgi structure and function.

Some Proteins Undergo Further Processing While Inside Vesicles

Some proteins are subjected to further processing by **proteolysis** while inside either transport or secretory vesicles. For example, **albumin** is synthesized by hepatocytes as **preproalbumin** (see Chapter 52). Its signal peptide is removed, converting it to **proalbumin**. In turn, proalbumin, while inside secretory vesicles, is converted to **albumin** by action of **furin** (Figure 49–14). This enzyme cleaves a hexapeptide from proalbumin immediately C-terminal to a dibasic amino acid site (ArgArg). The resulting mature albumin is secreted into the plasma. Hormones such as **insulin** (see Chapter 41) are

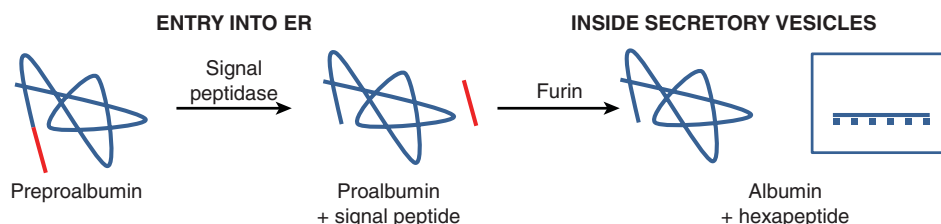

FIGURE 49–14 Processing of preproalbumin albumin. The signal peptide is removed from preproalbumin as it moves into the ER. Furin cleaves proalbumin at the C-terminal end of a basic dipeptide (ArgArg) while the protein is inside the secretory vesicle. The mature albumin is secreted into the plasma.

subjected to similar proteolytic cleavages while inside secretory vesicles.

THE ASSEMBLY OF MEMBRANES IS COMPLEX

There are a number of different types of cell membranes, ranging from the plasma membrane which separates the cell contents from the external environment to the internal membranes of subcellular organelles such as mitochondria and the ER. Although the general lipid bilayer structure is similar in all membranes, they differ in their specific protein and lipid content and each type has its own specific features (see Chapter 40). No satisfactory scheme describing the assembly of any one of these membranes is currently available. Vesicular transport and the way in which various proteins are initially inserted into the membrane of the ER have been discussed above. Some general points about membrane assembly are addressed below.

Asymmetry of Both Proteins & Lipids Is Maintained During Membrane Assembly

Vesicles formed from membranes of the ER and Golgi apparatus, either naturally or pinched off by homogenization, exhibit **transverse asymmetries** of both lipid and protein. These **asymmetries are maintained** during fusion of transport vesicles with the plasma membrane. The **inside** of the vesicles after fusion becomes the **outside of the plasma membrane**, and the cytoplasmic side of the vesicles remains the cytoplasmic side of the membrane (Figure 49–15). **Phospholipids** are the major class of lipid in membranes. The enzymes responsible for the synthesis of phospholipids reside in the cytoplasmic surface of the cisternae (the sac-like structures) of the ER. As phospholipids are synthesized at that site, they probably self-assemble into thermodynamically stable bimolecular layers, thereby expanding the membrane and perhaps promoting the detachment of so-called **lipid vesicles** from it. It has been proposed that these vesicles travel to other sites, donating their lipids to other membranes. Cytosolic proteins that take up phospholipids from one membrane and release them to another (ie, **phospholipid exchange proteins**) have been demonstrated; they probably play a role in contributing to the specific lipid composition of various membranes.

It should be noted that the **lipid compositions** of the ER, Golgi, and plasma membrane differ, the latter two membranes containing **higher amounts of cholesterol, sphingomyelin, and glycosphingolipids**, and **less phosphoglycerides** than does the ER. Sphingolipids pack more densely in membranes than do phosphoglycerides. These differences affect the structures and functions of membranes. For example, the **thickness of the bilayer** of the GA and PM is greater than that of the ER, which affects which particular transmembrane proteins are found in these organelles. Also, **lipid rafts** (see Chapter 40) are believed to be formed in the GA.

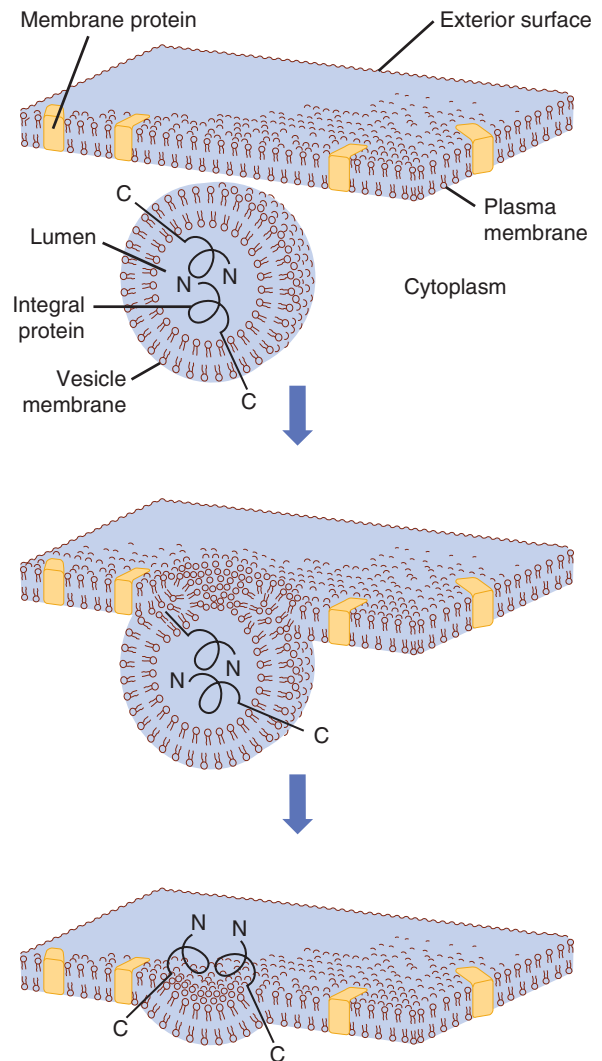

FIGURE 49–15 Fusion of a vesicle with the plasma membrane preserves the orientation of any integral proteins embedded in the vesicle bilayer. Initially, the amino terminal of the protein faces the lumen, or inner cavity, of such a vesicle. After fusion, the amino terminal is on the exterior surface of the plasma membrane. The lumen of a vesicle and the outside of the cell are topologically equivalent. (Redrawn and modified, with permission, from Lodish HF, Rothman JE: The assembly of cell membranes. *Sci Am* [Jan] 1979;240:43.)

Lipids & Proteins Undergo Turnover at Different Rates in Different Membranes

It has been shown that the half-lives of the lipids of the ER membranes of rat liver are generally shorter than those of its proteins, so that the **turnover rates of lipids and proteins are independent**. Indeed, different lipids have been found to have different half-lives. Furthermore, the half-lives of the proteins of these membranes vary widely, some exhibiting short (hours) and others long (days) half-lives. Thus, individual lipids and proteins of the ER membranes appear to be inserted into it relatively independently and this is believed to be the case for many other membranes.

The biogenesis of membranes is thus a complex process about which much remains to be learned. One indication

TABLE 49–10 Some Major Features of Membrane Assembly

<ul style="list-style-type: none"> • Lipids and proteins are inserted independently into membranes.
<ul style="list-style-type: none"> • Individual membrane lipids and proteins turn over independently and at different rates.
<ul style="list-style-type: none"> • Topogenic sequences [eg, signal (amino terminal or internal) and stop-transfer] are important in determining the insertion and disposition of proteins in membranes.
<ul style="list-style-type: none"> • Membrane proteins inside transport vesicles bud off the endoplasmic reticulum on their way to the Golgi; final sorting of many membrane proteins occurs in the trans-Golgi network.
<ul style="list-style-type: none"> • Specific sorting sequences guide proteins to particular organelles such as lysosomes, peroxisomes, and mitochondria.

of the complexity involved is to consider the number of **posttranslational modifications** that membrane proteins may be subjected to prior to attaining their mature state. These include disulfide formation, proteolysis, assembly into mul-timers, glycosylation, addition of a glycoposphatidylinositol (GPI) anchor, sulfation on tyrosine or carbohydrate moieties, phosphorylation, acylation, and prenylation—a list that is not complete. Nevertheless, significant progress has been made; **Table 49–10** summarizes some of the major features of membrane assembly that have emerged to date.

Various Disorders Result From Mutations in Genes Encoding Proteins Involved in Intracellular Transport

Some disorders reflecting abnormal **peroxisomal** function and abnormalities of protein synthesis in the **ER** and of the synthesis of **lysosomal proteins** have been listed earlier in this chapter (see Tables 49–4 and 49–7, respectively). Many other mutations affecting folding of proteins and their intracellular transport to various organelles have been reported, including neurodegenerative disorders such as Alzheimer disease, Huntington disease, and Parkinson disease. The elucidation of the causes of these various **conformational disorders** has contributed significantly to our understanding of **molecular pathology**. The term “**diseases of proteostasis deficiency**” has also been applied to diseases due to misfolding of proteins. Proteostasis is a composite word derived from protein homeostasis. Normal proteostasis is due to a balance of many factors, such as synthesis, folding, trafficking, aggregation, and normal degradation. If any one of these is disturbed (eg, by mutation, aging, cell stress, or injury), a variety of disorders can occur, depending on the particular proteins involved.

Potential therapies for the various diseases caused by protein dysfunction due to misfolding are aimed at correcting the conformational errors. One promising approach is to employ chaperones such as Hsp70 to promote proper folding. In addition, the antibiotic geldanamycin has been shown to activate heat shock proteins. Small drug molecules that act as chemical chaperones have also been shown prevent misfolding and

restore protein function. These approaches, however, have so far been tested in animal experiments and in vitro systems and their effectiveness in humans remains to be established.

SUMMARY

- Many proteins are targeted to their destinations by signal sequences. A major sorting decision is made when proteins are partitioned between cytosolic (or free) and membrane-bound polyribosomes by virtue of the absence or presence of an N-terminal signal peptide.
- Proteins synthesized on cytosolic polyribosomes are targeted by specific signal sequences to mitochondria, nuclei, peroxisomes, and the endoplasmic reticulum. Proteins which lack a signal remain in the cytosol.
- Proteins synthesized on membrane bound polyribosomes initially enter the ER membrane or lumen, and many are ultimately destined for other membranes including the PM and that of the GA, for lysosomes and for secretion via exocytosis via transport from the ER → GA → PM in transport vesicles.
- Many glycosylation reactions occur in compartments of the Golgi, and proteins are further sorted in the *trans*-Golgi network.
- Molecular chaperones stabilize unfolded or partially folded proteins. Chaperones are required for the correct targeting of proteins to their subcellular locations.
- In posttranslational translocation, proteins are transported to their target organelles after their synthesis is complete. Proteins destined for mitochondria, the nucleus, and peroxisomes follow this route, as well as a minority of proteins targeted to the ER.
- Most proteins enter the ER lumen by the cotranslational pathway, where translocation occurs during ongoing protein synthesis.
- Proteins embedded in the ER membrane may be inserted cotranslationally, posttranslationally or after transport to the GA (anterograde transport), transient retention and return to the ER (retrograde transport).
- Harmful buildup of misfolded proteins triggers the unfolded protein response and they are degraded via the ERAD pathway. Proteins are tagged for degradation by the addition of a number of ubiquitin molecules and then enter the cytosol where they are broken down in proteasomes.
- Different types of transport vesicles are coated with different proteins. Clathrin-coated vesicles are destined for exocytosis and lysosomes, while coat proteins I and II are associated with COPI and COPII vesicles, which are responsible retrograde and anterograde transport, respectively.
- Transport vesicle processing is complex and requires many protein factors. Budding from the donor membrane is followed by movement through the cytosol, tethering, docking, and fusion with the target membrane.
- Certain proteins (eg, precursors of albumin and insulin) are subjected to proteolysis while inside transport vesicles, producing the mature proteins.
- Small GTPases (eg, Ran, Rab) and GEFs play key roles in many aspects of intracellular trafficking.
- Vesicles formed from membranes of the ER and Golgi apparatus are asymmetrical in both lipid and protein content. The asymmetry is maintained during fusion of transport

vesicles with the plasma membrane, so that the inside of the vesicles after fusion becomes the outside of the plasma membrane, and the cytoplasmic side of the vesicles remains facing the cytosol.

- Asymmetry of both lipids and proteins is maintained during membrane assembly. Lipids and proteins are inserted independently and turn over at different rates. Details of the complex assembly process remain to be established.
- Many disorders have been shown to be due to mutations in genes or to other factors that affect the folding of various proteins. These conditions have been referred to as conformational diseases, or alternatively as diseases of proteostatic deficiency. Promising therapeutic approaches include the use of chaperones such as Hsp70 and small molecules that can prevent misfolding and restore protein function.

REFERENCES

Alberts B, Johnson A, Lewis J, et al: *Molecular Biology of the Cell*, 5th ed. Garland Science, 2008. (An excellent textbook of cell biology, with comprehensive coverage of trafficking and sorting.)

Alder NN, Johnson AE: Cotranslational membrane protein biogenesis at the endoplasmic reticulum. *J Biol Chem* 2004;279:22787.

Bonifacino JS, Glick BS: The mechanisms of vesicle budding and fusion. *Cell* 2004;116:153.

Chaudhuri TK, Paul S: Protein misfolding diseases and chaperone-based therapeutic approaches. *FEBS J* 2006;273:1331.

Cooper GM, Hausman RE: *The Cell: A Molecular Approach*. Sinauer Associates, Inc. 2009. (An excellent textbook of cell biology, with comprehensive coverage of trafficking and sorting.)

Hampton RY, Sommer T: Finding the will and the way of ERAD substrate retrotranslocation. *Curr Opin Cell Biol* 2012;24:460.

Hebert DN, Molinari M: In and out of the ER: protein folding, quality control, degradation and related human diseases. *Physiol Rev* 2007;87:1377.

Lai E, Teodoro T, Volchuk A: Endoplasmic reticulum stress: signaling the unfolded protein response. *Physiology* 2007;22:193.

Neupert W, Herrmann JM: Translocation of proteins into mitochondria. *Annu Rev Biochem* 2007;76:723.

Platta HW, Erdmann R: The peroxisomal protein import machinery. *FEBS Lett* 2007;581:2811.

Stewart M: Molecular mechanisms of the nuclear protein import cycle. *Nature Rev Mol Cell Biol* 2007;8:195.

The Extracellular Matrix

Kathleen M. Botham, PhD, DSc & Robert K. Murray, MD, PhD

OBJECTIVES

After studying this chapter, you should be able to:

- Appreciate the importance of the extracellular matrix (ECM) and its components in health and disease.
- Describe the structural and functional properties of collagen and elastin, the major proteins of the ECM.
- Indicate the major features of fibrillin, fibronectin, and laminin, other important proteins of the ECM.
- Describe the properties and general features of the synthesis and degradation of glycosaminoglycans and proteoglycans, and their contributions to the ECM.
- Give a brief account of the major biochemical features of bone and cartilage.

BIOMEDICAL IMPORTANCE

Most mammalian cells are located in tissues where they are surrounded by a complex **ECM** often referred to as “**connective tissue**,” which protects the organs and also provides elasticity where required (eg, in blood vessels, lungs, and skin). The ECM contains three major classes of biomolecules: **structural proteins** (1), for example, **collagen, elastin, and fibrillin**, certain **specialized proteins** (2) such as **fibronectin and laminin**, which form a mesh of fibers that are embedded in **proteoglycans** (3). The ECM has been found to be involved in many normal and pathologic processes—for example, it plays important roles in development, in inflammatory states, and in the spread of cancer cells. Involvement of certain components of the ECM has been documented in both **rheumatoid arthritis** and **osteoarthritis**. Several diseases (eg, osteogenesis imperfecta and a number of types of the Ehlers-Danlos syndrome) are due to genetic disturbances of the synthesis of collagen. Specific components of proteoglycans (the glycosaminoglycans; GAGs) are affected in the group of genetic disorders known as the **mucopolysaccharidoses**. Changes occur in the ECM during the **aging process**. This chapter describes the basic biochemistry of the three major classes of biomolecules found in the ECM and illustrates their biomedical significance. Major biochemical features of two specialized forms of ECM—bone and cartilage—and of a number of diseases involving them are also briefly considered.

COLLAGEN IS THE MOST ABUNDANT PROTEIN IN THE ANIMAL WORLD

Collagen, the major component of most connective tissues, constitutes approximately 25% of the protein of mammals. It provides an extracellular framework for all metazoan animals and exists in virtually every animal tissue. At least 28 distinct types of collagen made up of over 30 distinct polypeptide chains (each encoded by a separate gene) have been identified in human tissues (**Table 50–1**). Although several of these are present only in small proportions, they may play important roles in determining the physical properties of specific tissues. In addition, a number of proteins (eg, the C1q component of the complement system, pulmonary surfactant proteins SPA and SPD) that are not classified as collagens have collagen-like domains in their structures; these proteins are sometimes referred to as “noncollagen collagens.”

COLLAGENS HAVE A TRIPLE HELIX STRUCTURE

All collagen types have a **triple helical structure**. In some collagens, the entire molecule is triple helical, whereas in others the triple helix may involve only a fraction of the

TABLE 50–1 Types of Collagen and Their Tissue Distribution

Type	Distribution	Type	Distribution
I	Noncartilaginous connective tissues, including bone, tendon, skin	XV	Associated with collagens close to basement membranes in many tissues including in eye, muscle, microvessels
II	Cartilage, vitreous humor	XVI	Many tissues
III	Extensible connective tissues, including skin, lung, vascular system	XVII	Epithelia, skin hemidesmosomes
IV	Basement membranes	XVIII	Associated with collagens close to basement membranes, close structural homologue of XV
V	Minor component in tissues containing collagen I	XIX	Rare, basement membranes, rhabdomyosarcoma cells
VI	Muscle and most connective tissues	XX	Many tissues, particularly corneal epithelium
VII	Dermal-epidermal junction	XXI	Many tissues
VIII	Endothelium and other tissues	XXII	Tissue junctions, including cartilage-synovial fluid, hair follicle-dermis
IX	Tissues containing collagen II	XXIII	Limited in tissues, mainly transmembrane and shed forms
X	Hypertrophic cartilage	XXIV	Developing cornea and bone
XI	Tissues containing collagen II	XXV	Brain
XII	Tissues containing collagen I	XXVI	Testis, ovary
XIII	Many tissues, including neuromuscular junctions and skin	XXVII	Embryonic cartilage and other developing tissues, cartilage in adults
XIV	Tissues containing collagen I	XXVIII	Basement membrane around Schwann cells

structure. Mature **collagen type I**, containing approximately 1000 amino acids, belongs to the former type; in it, each polypeptide subunit or alpha chain is twisted into a left-handed polyproline helix of three residues per turn. Three of these alpha chains are then wound into a **right-handed superhelix**, forming a rodlike molecule 1.4 nm in diameter and about 300 nm long (**Figure 50–1**). A striking characteristic of collagen is the occurrence of **glycine** residues at every third position of the triple helical portion of the alpha chain. This is necessary because glycine is the only amino acid small enough to be accommodated in the limited space available in the central core of the triple helix. This **repeating structure**, represented as (Gly-X-Y)*n*, is an absolute requirement for the formation of the triple helix. While X and Y can be any other amino acids, about 100 of the X positions are proline and about 100 of the Y positions are hydroxyproline. Proline and hydroxyproline confer **rigidity** on the collagen molecule. **Hydroxyproline** is formed by the posttranslational hydroxylation of peptide-bound proline residues catalyzed by the enzyme **prolyl hydroxylase**, whose cofactors are **ascorbic acid** (vitamin C) and α -ketoglutarate. Lysines in the Y position may also be posttranslationally modified to hydroxylysine through the action of **lysyl hydroxylase**, an enzyme with similar cofactors. Some of these hydroxylysines may be further modified by the addition of galactose or galactosyl-glucose through an **O-glycosidic linkage** (see Chapter 46), a glycosylation site that is unique to collagen.

Collagen types that form long rodlike fibers in tissues are assembled by lateral association of these triple helical units into **fibrils** (10–300 nm in diameter) in a “**quarter staggered**” alignment such that each is displaced longitudinally from its neighbor by slightly less than one-quarter of its length (**Figure 50–1**). Fibrils, in turn, associate into thicker fibers (1–20 μ m in diameter). Because the quarter staggered alignment results in regularly spaced gaps between the triple helical molecules in the array, fibers have a banded appearance in connective tissues. In some tissues, for example tendons, fibers associate into even larger bundles, which may have a diameter of up to 500 μ m. Collagen fibers are further stabilized by the formation of **covalent cross-links**, both within and between the triple helical units. These cross-links form through the action of **lysyl oxidase**, a copper-dependent enzyme that oxidatively deaminates the ϵ -amino groups of certain lysine and hydroxylysine residues, yielding reactive aldehydes. Such aldehydes can form aldol condensation products with other lysine- or hydroxylysine-derived aldehydes or form Schiff bases with the ϵ -amino groups of unoxidized lysines or hydroxylysines. These reactions, after further chemical rearrangements, result in the stable covalent cross-links that are important for the tensile strength of the fibers. Histidine may also be involved in certain cross-links.

The main fibril forming collagens in skin and bone and in cartilage, respectively, are types **I** and **II**, although other collagens also adopt this structure. In addition, however, there

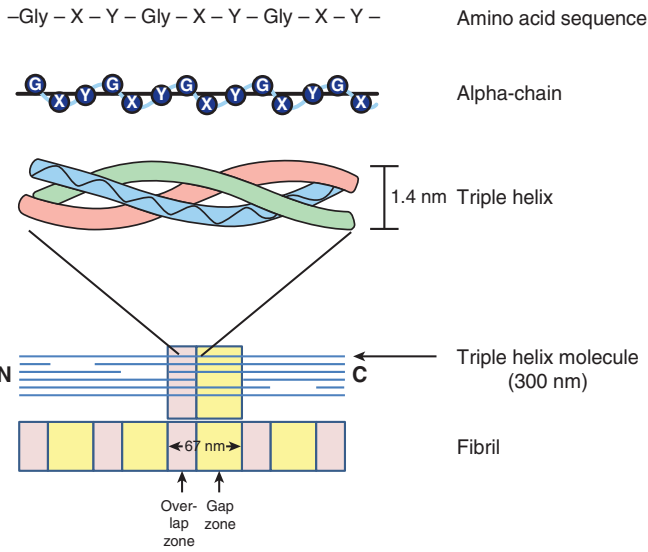

FIGURE 50-1 Molecular features of collagen structure from the primary sequence to the fibril. Each individual polypeptide chain is twisted into a left-handed helix of three residues (Gly-X-Y) per turn, and three of these chains are then wound into a right-handed superhelix. The triple helices are then assembled into a quarter staggered alignment to form fibrils. This arrangement leads to areas where there is complete overlap of the molecules alternating with areas where there is a gap, giving the fibrils a regular banded appearance. (Slightly modified and reproduced, with permission, from Eyre DR: Collagen: molecular diversity in the body’s protein scaffold. Science 1980;207:1315. Reprinted with permission from AAAS.)

are many nonfibril forming collagens and their structures and functions are described briefly in the section below.

Some Collagen Types Do Not Form Fibrils

Several collagen types do not form fibrils in tissues (Figure 50-2). They are characterized by interruptions of the triple helix with stretches of protein lacking Gly-X-Y repeat sequences. These non-Gly-X-Y sequences result in areas of globular structure interspersed in the triple helical structure. **Network-like collagens** such as type IV form networks in basement membranes; **fibril-associated collagens with interrupted triple helices**

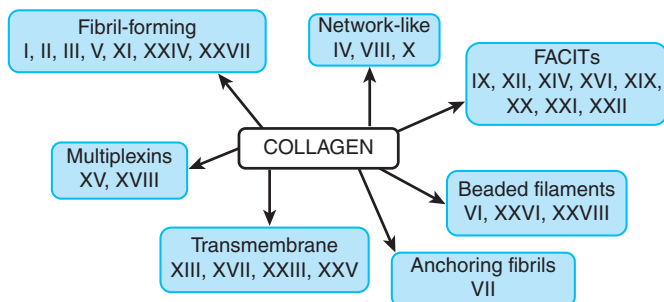

FIGURE 50-2 Classification of collagens according to the structures they form. FACIT, fibril-associated collagen with interrupted triple helices; multiplexin, multiple triple helix domains and interruptions.

(**FACITs**), as their name indicates, have interruptions in the triple helical domains; beaded filaments consist of long chains of collagen molecules which have a regular beaded appearance; collagen VII forms the main part of **anchoring fibrils** in epithelial tissues; **transmembrane collagens** have short intracellular N-terminal domains and extracellular domains with long interrupted triple helices; **multiplexins** are collagens with multiple triple helix domains and interruptions.

Collagen Undergoes Extensive Posttranslational Modifications

Newly synthesized collagen undergoes extensive **posttranslational modification** before becoming part of a mature extracellular collagen fiber (Table 50-2). Like most secreted proteins, collagen is synthesized on ribosomes in a precursor form, **procollagen**, which contains a leader or signal sequence that directs the polypeptide chain into the lumen of the endoplasmic reticulum, this leader sequence is enzymatically removed. **Hydroxylation** of proline and lysine residues and **glycosylation** of hydroxylysines in the **procollagen** molecule also take place at this site. The procollagen molecule contains polypeptide extensions (**extension peptides**) of 20 to 35 kDa at both its amino and carboxyl terminal ends, neither of which is present in mature collagen. Both extension peptides contain cysteine residues. While the amino terminal propeptide forms only intrachain disulfide bonds, the carboxyl terminal propeptides form both intrachain and interchain disulfide bonds. Formation of these disulfide bonds assists in the **registration** of the three collagen molecules to form the triple helix, winding from the carboxyl terminal end. After formation of the triple helix, no further hydroxylation of proline or lysine or glycosylation of hydroxylysines can take place. **Self-assembly** is a cardinal principle in the biosynthesis of collagen.

TABLE 50-2 Order and Location of Processing of the Fibrillar Collagen Precursor

Intracellular
1. Cleavage of signal peptide
2. Hydroxylation of prolyl residues and some lysyl residues; glycosylation of some hydroxylysyl residues
3. Formation of intrachain and interchain S-S bonds in extension peptides
4. Formation of triple helix
Extracellular
1. Cleavage of amino and carboxyl terminal propeptides
2. Assembly of collagen fibers in quarter-staggered alignment
3. Oxidative deamination of ε-amino groups of lysyl and hydroxylysyl residues to aldehydes
4. Formation of intra- and interchain cross-links via Schiff bases and aldol condensation products

Following **secretion** from the cell by way of the Golgi apparatus, extracellular enzymes called **procollagen aminoproteinase** and **procollagen carboxyproteinase** remove the extension peptides at the amino and carboxyl terminal ends, respectively forming the monomeric units of collagen, termed **tropocollagen**. Cleavage of the propeptides may occur within crypts or folds in the cell membrane. Once the propeptides are removed, the tropocollagen molecules, containing approximately 1000 amino acids per chain, **spontaneously assemble** into collagen fibers. These are further stabilized by the formation of **inter- and intrachain cross-links** through the action of lysyl oxidase, as described previously.

The same cells that secrete collagen also secrete **fibronectin**, a large glycoprotein present on cell surfaces, in the extracellular matrix, and in blood (see below). Fibronectin binds collagen fibers during aggregation and alters the kinetics of fiber formation in the pericellular matrix. Associated with fibronectin and procollagen in this matrix are the **proteoglycans** heparan sulfate and chondroitin sulfate (see below). In fact, **type IX collagen**, a minor collagen type from cartilage, contains an attached glycosaminoglycan chain. Such interactions may serve to regulate the formation of collagen fibers and to determine their orientation in tissues.

Once formed, collagen is relatively **metabolically stable**. However, its breakdown is increased during starvation and various inflammatory states. Excessive production of collagen occurs in a number of conditions, for example, hepatic cirrhosis.

A Number of Genetic & Deficiency Diseases Result From Abnormalities in the Synthesis of Collagen

More than 30 genes encode the collagens, and they are designated according to the procollagen type and their constituent α chains, called pro α chains. Collagens may be homotrimeric, containing three identical pro α chains, or heterotrimeric, where the pro α chains are different. For example, type I collagen is heterotrimeric, containing two pro α 1(I) and one pro α 2(I) chains (the arabic number refers to the pro α chain, and the roman numeral in parentheses indicates the collagen type), while type II collagen is homotrimeric, having three pro α 1(II) chains. Collagen genes have the prefix *COL* followed by the type in arabic numerals, then an A and the number of the pro α chain they encode. Thus *COL1A1* and *COL1A2* are the genes for the pro α 1 and 2 chains of type I collagen, *COL2A1* is the gene for the pro α 1 chain of type II collagen, and so on.

The pathway of collagen biosynthesis is complex, involving at least eight enzyme-catalyzed posttranslational steps. Thus, it is not surprising that a number of diseases (**Table 50–3**) are due to **mutations in collagen genes** or in **genes encoding some of the enzymes** involved in these post-translational modifications. Diseases affecting bone (eg, osteogenesis imperfecta) and cartilage (eg, the chondrodysplasias) will be discussed later in this chapter.

TABLE 50–3 Diseases Caused by Mutations in Collagen Genes or by Deficiencies in the Activities of Enzymes Involved in the Posttranslational Biosynthesis of Collagen

Gene or Enzyme affected	Disease ^a
<i>COL1A1</i> , <i>COL1A2</i>	Osteogenesis imperfecta type 1 ^b Osteoporosis Ehlers-Danlos syndrome, subtype arthrochalasia
<i>COL2A1</i>	Severe chondrodysplasia Osteoarthritis
<i>COL3A1</i>	Ehlers-Danlos syndrome, subtype vascular
<i>COL4A3</i> - <i>COL4A6</i>	Alport syndrome (autosomal and X-linked)
<i>COL7A1</i>	Epidermolysis bullosa, dystrophic
<i>COL10A1</i>	Schmid metaphyseal chondrodysplasia
<i>COL5A1</i> , <i>COL5A2</i> , <i>COL1A1</i>	Ehlers-Danlos syndrome, subtype classical
<i>COL3A1</i> , tenascin XB (<i>TNXB</i>)	Ehlers-Danlos syndrome, subtype hypermobility
Lysyl hydroxylase	Ehlers-Danlos syndrome, subtype kyphoscoliosis
ADAM metalloproteinase with thrombospondin type 1 motif (<i>ADAMTS2</i>) (also called Procollagen N-proteinase)	Ehlers-Danlos syndrome, subtype dermatosparaxis
Lysyl hydroxylase	Menkes disease ^c

^aGenetic linkage to collagen genes has been shown to a few other conditions not listed here.

^bEight different types of Osteogenesis imperfecta are recognized, but most cases are caused by mutations in the *COL1A1* and *COL1A2* genes.

^cSecondary to a deficiency of copper (see Chapter 52).

Ehlers-Danlos syndrome (formerly called Cutis hyperelastica), comprises a group of inherited disorders whose principal clinical features are hyperextensibility of the skin, abnormal tissue fragility, and increased joint mobility. The clinical picture is variable, reflecting underlying extensive genetic heterogeneity. A number of forms of the disease caused by genetic defects in proteins involved in the synthesis and assembly of collagens type I, III and V are known, and since 1997 the Villefranche classification of 6 subtypes based on their phenotype and molecular defects has been used (**Table 50–4**). The **hypermobility, vascular and classical** subtypes are more common, while the other three, **kyphoscoliosis, arthrochalasia and dermatosparaxis** are extremely rare. The vascular subtype is the most serious because of its tendency for spontaneous rupture of arteries or the bowel, reflecting abnormalities in type III collagen. Patients with kyphoscoliosis exhibit progressive curvature of the spine (scoliosis) and a tendency to ocular rupture due to a deficiency of lysyl hydroxylase. A deficiency of procollagen N-proteinase (ADAM metalloproteinase with thrombospondin type 1 motif [*ADAMTS2*]), causing formation of abnormal thin, irregular

TABLE 50-4 The Villefranche Classification^a of Ehlers Danlos Syndrome Subtypes

Subtype Name	Defect in	Incidence	Clinical Signs
Hypermobility	Type III collagen, tenascin X ^b	1:10,000-15,000	Joint hypermobility, skin abnormalities, osteoarthritis, severe pain
Classical	Types I and V collagen	1:20,000-30,000	Similar to the Hypermobility subtype, but with more severe skin abnormalities and less severe joint changes
Vascular	Type III collagen	1:100,000	Fragile blood vessels and organs, small stature, thin and translucent skin, easy bruising
Kyphoscoliosis	Lysyl hydroxylase	<60 cases	Curvature of the spine (scoliosis), severe muscle weakness, fragile eyes, hyper-extensible and bruisable skin
Arthrochalasia	Type I collagen	<40 cases	Very loose joints and dislocation of both hips
Dermatosparaxis	ADAM metalloproteinase with thrombospondin type 1 motif (ADAMTS2) ^c	<10 cases	Very fragile and sagging skin

^aBeighton P, De Paepe A, Steinmann B, et al: Ehlers-Danlos syndromes: revised nosology, Villefranche, Ehlers-Danlos National Foundation (USA) and Ehlers-Danlos Support Group (UK). *Am J Med Genet* 1998;64:31-37.

^bA glycoprotein expressed in connective tissues such as skin, joints and muscles.

^cAlso called procollagen N-proteinase.

collagen fibrils, results in dermatosparaxis, manifested by marked fragile and sagging skin.

The **Alport syndrome** (hereditary nephritis) is the designation applied to a number of genetic disorders (both X-linked and autosomal) affecting **type IV** collagen, a network-like collagen which forms part of the structure of the basement membranes of the renal glomeruli, inner ear and eye (see discussion of laminin, below). Mutations in several genes encoding type IV collagen fibers have been demonstrated. The main presenting sign is hematuria, accompanied by ocular lesions and hearing loss, and patients may eventually develop end-stage renal disease. Electron microscopy reveals characteristic abnormalities of the structure of the basement membrane and lamina densa.

In **epidermolysis bullosa**, the skin breaks and blisters as a result of minor trauma. The dystrophic form is due to mutations in *COL7A1*, affecting the structure of **type VII** collagen. This collagen forms delicate fibrils that anchor the basal lamina to collagen fibrils in the dermis. These anchoring fibrils have been shown to be markedly reduced in this form of the disease, probably resulting in the blistering. Epidermolysis bullosa simplex, another variant, is due to mutations in keratin 5 (see Chapter 51).

Scurvy affects the structure of collagen. However, it is due to a **deficiency of ascorbic acid** (vitamin C) (see Chapter 44), and is not a genetic disease. Its major signs are bleeding gums, subcutaneous hemorrhages, and poor wound healing. These signs reflect defective synthesis of collagen due to reduced activity of the enzymes **prolyl and lysyl hydroxylases**, both of which require ascorbic acid as a cofactor and are involved in posttranslational modifications which give collagen molecules rigidity.

In **Menkes disease**, deficiency of copper results in defective cross-linking of collagen and elastin by the copper-dependent enzyme lysyl oxidase. (Menkes disease is discussed in Chapter 52.)

ELASTIN CONFERS EXTENSIBILITY & RECOIL ON LUNG, BLOOD VESSELS & LIGAMENTS

Elastin is a connective tissue protein that is responsible for properties of extensibility and elastic recoil in tissues. Although not as widespread as collagen, elastin is present in large amounts, particularly in tissues that require these physical properties, for example, lung, large arterial blood vessels, and some elastic ligaments. Smaller quantities of elastin are also found in skin, ear cartilage, and several other tissues. In contrast to collagen, there appears to be only one genetic type of elastin, although variants arise by alternative splicing (see Chapter 36) of the hnRNA for elastin. Elastin is synthesized as a soluble monomer of ~70 kDa called **tropoelastin**. Some of the prolines of tropoelastin are hydroxylated to **hydroxyproline** by prolyl hydroxylase, though hydroxylysine and glycosylated hydroxylysine are not present. Unlike collagen, tropoelastin is not synthesized in a pro-form with extension peptides. Furthermore, elastin does not contain repeat Gly-X-Y sequences, triple helical structure, or carbohydrate moieties.

After secretion from the cell, certain lysyl residues of tropoelastin are oxidatively deaminated to aldehydes by **lysyl oxidase**, the same enzyme involved in this process in collagen. However, the major cross-links formed in elastin are the **desmosines**, which result from the condensation of three of these lysine-derived aldehydes with an unmodified lysine to form a tetrafunctional cross-link unique to elastin. Once cross-linked in its mature, extracellular form, elastin is highly insoluble and **extremely stable** and has a very low-turnover rate. Elastin exhibits a variety of random coil conformations that permit the protein to stretch and subsequently recoil during the performance of its physiologic functions.

TABLE 50-5 Major Differences Between Collagen and Elastin

Collagen	Elastin
1. Many different genetic types	One genetic type
2. Triple helix	No triple helix; random coil conformations permitting stretching
3. (Gly-X-Y) _n repeating structure	No (Gly-X-Y) _n repeating structure
4. Presence of hydroxylysine	No hydroxylysine
5. Carbohydrate-containing	No carbohydrate
6. Intramolecular aldol crosslinks	Intramolecular desmosine cross-links
7. Presence of extension peptides during biosynthesis	No extension peptides present during biosynthesis

Table 50-5 summarizes the main differences between collagen and elastin.

Deletions in the elastin gene (located at 7q11.23) have been found in approximately 90% of subjects with the **Williams-Beuren syndrome**, a developmental disorder affecting connective tissue and the central nervous system. The mutations, by affecting synthesis of elastin, probably play a causative role in the **supravalvular aortic stenosis** often found in this condition. Fragmentation or, alternatively, a decrease of elastin is found in conditions such as **pulmonary emphysema, cutis laxa, and aging of the skin**.

FIBRILLINS ARE STRUCTURAL COMPONENTS OF MICROFIBRILS

Microfibrils are fine fiber-like strands 10 to 12 nm in diameter which provide a **scaffold** for the deposition of elastin in the ECM. **Fibrillins** are large glycoproteins (about 350 kDa) that are major structural component of these fibers. They are secreted (subsequent to a proteolytic cleavage) into the ECM by fibroblasts and become incorporated into the insoluble microfibrils. **Fibrillin-1** is the main fibrillin present, but fibrillins-2 and -3 have also been identified, and fibrillin-2 is thought to be important in deposition of microfibrils early in development. Other proteins including **microfibril-associated proteins (MAGPs)**, **fibulins** and **members of the ADAMTS family** are also associated with microfibrils. Fibrillin microfibrils are found in elastic fibers and also in elastin-free bundles in the eye, kidney, and tendons.

Marfan Syndrome Is Caused by Mutations in the Gene for Fibrillin-1

Marfan syndrome is a relatively prevalent inherited disease affecting connective tissue; it is inherited as an autosomal dominant trait. It affects the **eyes** (eg, causing dislocation of the lens, known as **ectopia lentis**), the **skeletal system** (most patients

are tall and exhibit long digits [arachnodactyly] and hyperextensibility of the joints), and the **cardiovascular system** (eg, causing weakness of the aortic media, leading to dilation of the ascending aorta). Abraham Lincoln may have had this condition. Most cases are caused by mutations in the gene (on chromosome 15) for fibrillin-1; missense mutations have been detected in several patients with the Marfan syndrome. This results in abnormal fibrillin and/or lower amounts being deposited in the ECM. Since the cytokine **TGF-β** normally binds to fibrillin-1, decreased binding in Marfan syndrome causes disturbances in TGF-β signaling which contribute to the pathology found in the condition. This could potentially lead to the development of therapies for the condition using drugs that antagonize TGF-β (eg, the angiotensin II receptor antagonist, Losartan).

Mutations in the fibrillin-1 gene have also been identified recently as the cause of **acromicric dysplasia** and **geleophysic dysplasia**, which are characterized by short stature, skin thickening, and stiff joints. **Congenital contractural arachnodactyly** is associated with a mutation in the gene for fibrillin-2. The probable sequence of events leading to Marfan syndrome is summarized in **Figure 50-3**.

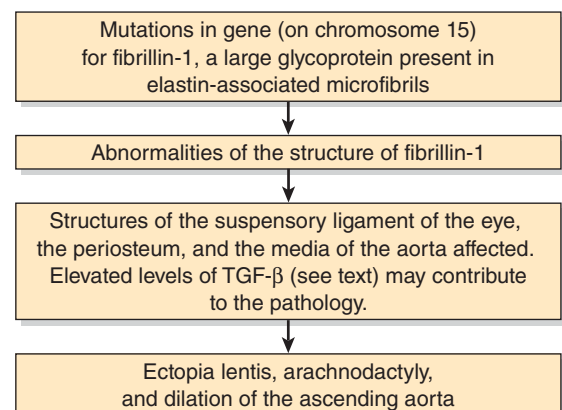

FIGURE 50-3 Probable sequence of events in the causation of the major signs exhibited by patients with Marfan syndrome.

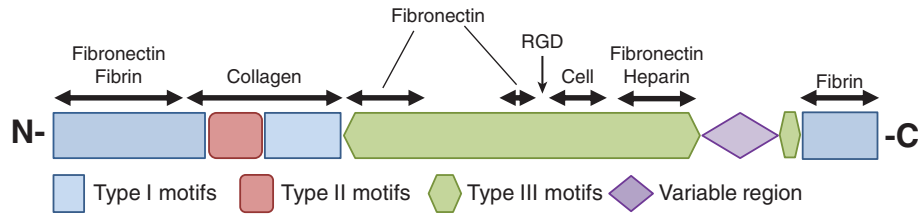

FIGURE 50-4 Structure of the fibronectin monomer. Fibronectin is a dimer joined by disulfide bridges (not shown) near the carboxyl terminals of the monomers. Each monomer consists mainly of repeating motifs of type I, II, or III and has a number of protein binding domains. Four bind fibronectin and there are also domains for collagen, heparin, fibrin, and cell binding. The approximate location of the RGD sequence of fibronectin, which interacts with a variety of fibronectin integrin receptors on cell surfaces, is indicated by the arrow.

FIBRONECTIN IS AN IMPORTANT GLYCOPROTEIN INVOLVED IN CELL ADHESION & MIGRATION

Fibronectin is a major glycoprotein of the extracellular matrix, also found in a soluble form in plasma. It consists of two identical subunits, each of about 230 kDa, joined by two disulfide bridges near their carboxyl terminals. The gene encoding fibronectin is very large, containing some 50 exons; the RNA produced by its transcription is subject to considerable alternative splicing, and as many as 20 different mRNAs have been detected in various tissues. Fibronectin contains three types of repeating motifs (I, II, and III), which are organized into functional **domains** (at least seven); functions of these domains include binding fibronectin, enabling molecules of the protein to interact, **heparin** (see below), fibrin, collagen, and cell surfaces (**Figure 50-4**). Fibronectin binds to cells via a transmembrane receptor protein which belongs to the **integrin** class of proteins (see Chapter 55). The integrins are heterodimers, containing various types of α and β polypeptide chains. Fibronectin contains an **Arg-Gly-Asp (RGD) sequence** that binds to the receptor. This sequence is shared by a number of other proteins present in the ECM that bind to integrins present in cell plasma membranes, and its presence in synthetic peptides enables them to inhibit the binding of fibronectin to cells. **Figure 50-5** illustrates the

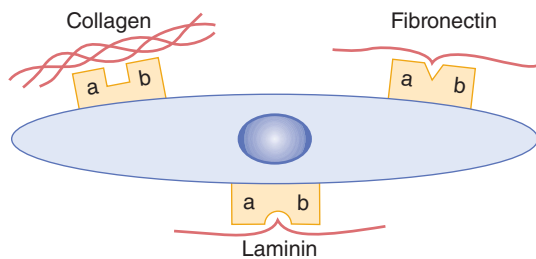

FIGURE 50-5 Schematic representation of a cell interactions with major proteins of the ECM. a and b indicate α and β polypeptide chains of integrins. (Redrawn after Yamada KM: Adhesive recognition sequences. J Biol Chem 1991;266:12809.)

interaction of collagen, fibronectin, and laminin, all major proteins of the ECM, with a typical cell (eg, fibroblast) present in the matrix.

The fibronectin receptor interacts indirectly with **actin** microfilaments (see Chapter 51) present in the cytosol (**Figure 50-6**). A number of proteins, collectively known as **attachment proteins**, are involved; these include **talin**, **vinculin**, **α -actinin** and **paxillin**. Talin links the integrin to actin via vinculin, which binds α -actinin and paxillin as well as actin. α -Actinin also binds actin, while paxillin binds to integrin. Such large protein complexes form **focal adhesions** which not only anchor cells in the ECM, but also relay signals from the exterior which influence cell behavior. Thus, the interaction of fibronectin with its receptor provides one route whereby the **outside of the cell can communicate with the inside**.

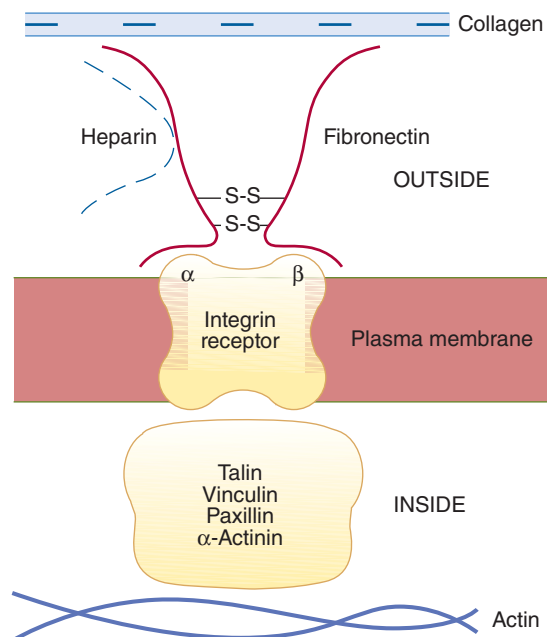

FIGURE 50-6 Schematic representation of fibronectin interacting with actin in the cytosol via an integrin fibronectin receptor. For simplicity, the attachment proteins are represented as a complex.

Fibronectin is also involved in **cell migration**, as it provides a binding site for cells and thus helps them to steer their way through the ECM. The amount of fibronectin around many **transformed cells** is sharply reduced, partly explaining their faulty interaction with the ECM.

LAMININ IS A MAJOR PROTEIN COMPONENT OF BASAL LAMINAS

Basal laminas are specialized areas of the ECM that surround epithelial and some other cells (eg, muscle cells). **Laminin** (a glycoprotein of about 850 kDa and 70 nm length) consists of three distinct elongated polypeptide chains (α , β , and γ chains) linked together to form a complex, elongated shape (see Figure 51–11, in which laminin is called **merosin**). There are a number of genetic variants of laminin, details of which will not be presented here. In basal laminas, laminin forms networks which are attached to type IV collagen networks by **entactin** (also called nidogen), a glycoprotein containing an RGD sequence and the heparan sulfate proteoglycan, **perlecan**. The collagen interacts with laminin (rather than directly with the cell surface), which in turn interacts with integrins or other proteins, such as **dystroglycans** (see Chapter 51) thus anchoring the lamina to the cells (Figure 50–7).

In the **renal glomerulus**, the basal lamina consists of two separate sheets of cells (one endothelial and one epithelial), each disposed on opposite sides of the lamina; these three layers make up the **glomerular membrane**. This relatively thick basal lamina has an important role in **glomerular filtration**, regulating the passage of large molecules (most plasma proteins) across the glomerulus into the renal tubule. The glomerular membrane allows small molecules, such as **inulin** (5.2 kDa), to pass through as easily as water. On the other hand, only a small amount of the protein **albumin** (69 kDa), the major plasma protein, passes through the normal glomerulus. This is explained by two sets of facts: (1) The **pores** in the glomerular membrane are large enough to allow molecules up to about 8 nm to pass through. (2) Albumin

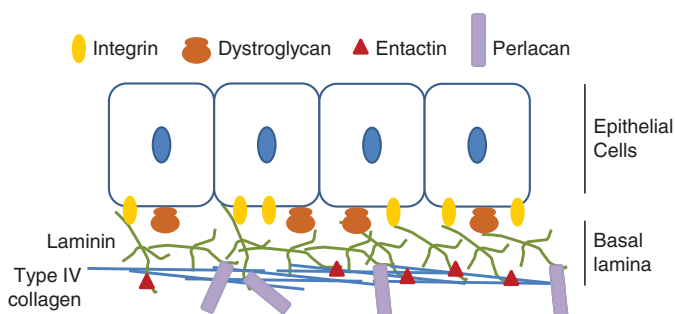

FIGURE 50–7 Structure of the basal lamina. Laminin is attached to type IV collagen via entactin and perlecan (forming the basal lamina) and to the epithelial cell layer via integrins and dystroglycans.

is smaller than this pore size, but it is prevented from passing through easily by the **negative charges** of heparan sulfate and of certain sialic acid-containing glycoproteins present in the lamina. These negative charges repel albumin and most plasma proteins, which are negatively charged at the pH of blood. The normal structure of the glomerulus may be severely damaged in certain types of **glomerulonephritis** (eg, caused by antibodies directed against various components of the glomerular membrane). This alters the pores and the amounts and dispositions of the negatively charged macromolecules referred to above, and relatively massive amounts of albumin (and of certain other plasma proteins) can pass through into the urine, resulting in severe **albuminuria**.

PROTEOGLYCANS & GLYCOSAMINOGLYCANS

The Glycosaminoglycans Found in Proteoglycans Are Built Up of Repeating Disaccharides

Proteoglycans are proteins that contain covalently linked **glycosaminoglycans** (GAGs) (see Chapter 15). At least 30 have been characterized and given names such as syndecan, betaglycan, serglycin, perlecan, aggrecan, versican, decorin, biglycan, and fibromodulin. The proteins bound covalently to glycosaminoglycans are called “**core proteins**.” Proteoglycans vary in tissue distribution, nature of the core protein, attached glycosaminoglycans, and their function; they have proved difficult to isolate and characterize, but the use of recombinant DNA technology is beginning to yield important information about their structures. The amount of **carbohydrate** in a proteoglycan is usually much greater than that found in a glycoprotein and may comprise up to 95% of its weight. **Figures 50–8 and 50–9** show the general structure of one particular proteoglycan, **aggrecan**, the major type found in cartilage. It is very large (about 2×10^3 kDa), with its overall structure resembling that of a bottlebrush. It contains a long strand of hyaluronic acid (one type of GAG) (see Chapter 15) to which link proteins are attached **noncovalently**. In turn, the link proteins interact noncovalently with core protein molecules from which chains of other GAGs (keratan sulfate and chondroitin sulfate in this case) project. More details on this macromolecule are given when cartilage is discussed below.

There are at least seven GAGs: **hyaluronic acid (hyaluronan)**, **chondroitin sulfate**, **keratan sulfates I and II**, **heparin**, **heparan sulfate**, and **dermatan sulfate**. GAGs are unbranched polysaccharides made up of repeating disaccharides, one component of which is always an **amino sugar** (hence, the name GAG), either D-glucosamine or D-galactosamine. The other component of the repeating disaccharide (except in the case of keratan sulfate) is a **uronic acid**, either L-glucuronic acid (GlcUA) or its 5′-epimer, L-iduronic acid (IdUA). With the exception of hyaluronic acid, all the GAGs contain **sulfate groups**, either as O-esters or as N-sulfate (in heparin and heparan sulfate). Hyaluronic acid is also exceptional because it appears to exist as

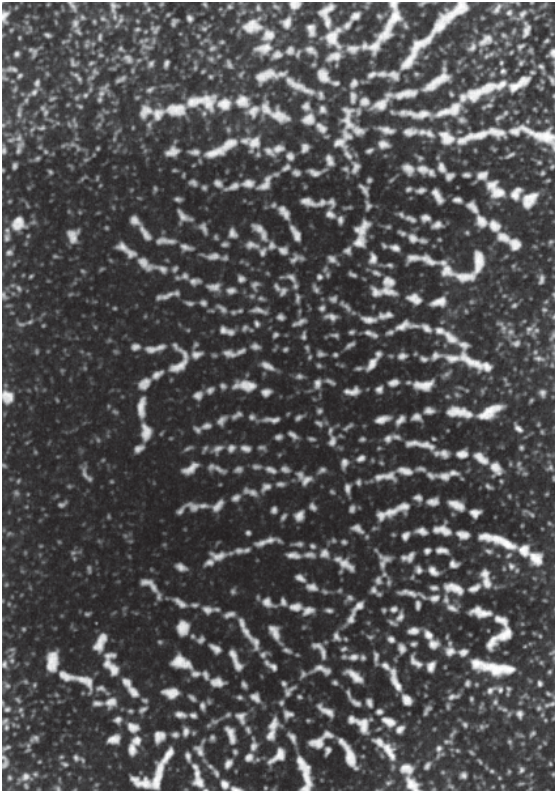

FIGURE 50–8 Darkfield electron micrograph of a proteoglycan aggregate. The proteoglycan subunits and filamentous backbone are particularly well extended in this image. (Reproduced, with permission, from Rosenberg L, Hellman W, Kleinschmidt AK: Electron microscopic studies of proteoglycan aggregates from bovine articular cartilage. *J Biol Chem* 1975;250:1877.)

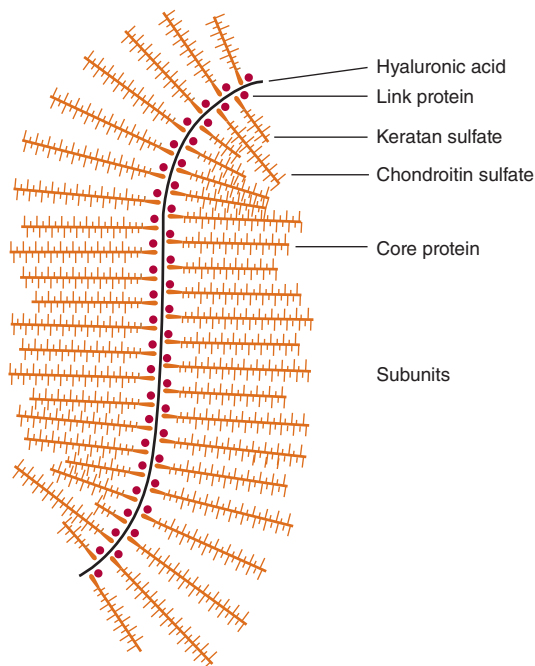

FIGURE 50–9 Schematic representation of the proteoglycan aggregate. (Reproduced, with permission, from Lennarz WJ: *The Biochemistry of Glycoproteins and Proteoglycans*. Plenum Press, 1980. Reproduced with kind permission from Springer Science and Business Media.)

a polysaccharide in the ECM, with no covalent attachment to protein, as the definition of a proteoglycan given above specifies. Both GAGs and proteoglycans have proved difficult to work with, partly because of their complexity. However, since they are major components of the ECM and have a number of important biologic roles as well as being involved in a number of disease processes, interest in them has increased greatly in recent years.

Biosynthesis of Glycosaminoglycans Involves Attachment to Core Proteins, Chain Elongation & Chain Termination

Attachment to Core Proteins

The linkage between GAGs and their core proteins is generally one of three types.

1. An **O-glycosidic bond** between **xylose (Xyl)** and **Ser**, a bond that is unique to proteoglycans. This linkage is formed by transfer of a Xyl residue to Ser from UDP-xylose. Two residues of Gal are then added to the Xyl residue, forming a **link trisaccharide**, Gal-Gal-Xyl-Ser. Further chain growth of the GAG occurs on the terminal Gal.
2. An **O-glycosidic bond** forms between **GalNAc** (*N*-acetylgalactosamine) and **Ser (Thr)** (see Figure 46–1A), present in keratan sulfate II. This bond is formed by donation to Ser (or Thr) of a GalNAc residue, employing UDP-GalNAc as its donor.
3. An **N-glycosylamine bond** between **GlcNAc** (*N*-acetylglucosamine) and the amide nitrogen of **Asn**, as found in *N*-linked glycoproteins (see Figure 46–1B). Its synthesis is believed to involve dolichol-PP oligosaccharide.

The synthesis of the core proteins occurs in the **endoplasmic reticulum**, and formation of at least some of the above linkages also occurs there. Most of the later steps in the biosynthesis of GAG chains and their subsequent modifications occur in the **Golgi apparatus**.

Chain Elongation

Appropriate **nucleotide sugars** and highly specific Golgi-located **glycosyltransferases** are employed to synthesize the oligosaccharide chains of GAGs. The “**one enzyme, one linkage**” relationship appears to hold here, as in the case of certain types of linkages found in glycoproteins. The enzyme systems involved in chain elongation are capable of high-fidelity reproduction of complex GAGs.

Chain Termination

This appears to result from (1) **sulfation**, particularly at certain positions of the sugars, and (2) the **progression** of the growing GAG chain away from the membrane site where catalysis occurs.

Further Modifications

After formation of the GAG chain, **numerous chemical modifications** occur, such as the introduction of sulfate groups onto

GalNAc and other moieties and the epimerization of GlcUA to IdUA residues. The enzymes catalyzing sulfation are designated **sulfotransferases** and use **3'-phosphoadenosine-5'-phosphosulfate** [PAPS; active sulfate] (see Chapter 32) as the sulfate donor. These Golgi-located enzymes are highly specific, and distinct enzymes catalyze sulfation at different positions (eg, carbons 2, 3, 4, and 6) on the acceptor sugars. An **epimerase** catalyzes conversions of glucuronyl to iduronyl residues.

Proteoglycans Are Important in the Structural Organization of the Extracellular Matrix

Proteoglycans are found in **every tissue** of the body, mainly in the ECM or “ground substance.” There they are associated with each other and also with the other major structural components of the matrix, collagen and elastin, in specific ways. Some proteoglycans bind to collagen and others to elastin. These interactions are important in determining the structural organization of the matrix. Some proteoglycans (eg, decorin) can also **bind growth factors** such as TGF- β , modulating their effects on cells. In addition, some of them interact with certain **adhesive proteins** such as fibronectin and laminin (see above), also found in the matrix. The GAGs present in the proteoglycans are **polyanions** and hence bind polycations and cations such as Na⁺ and K⁺. This latter ability attracts water by osmotic pressure into the extracellular

matrix and contributes to its turgor. GAGs also **gel** at relatively low concentrations. Because of the long extended nature of the polysaccharide chains of GAGs and their ability to gel, the proteoglycans can act as **sieves**, restricting the passage of large macromolecules into the ECM but allowing relatively free diffusion of small molecules. Again, because of their extended structures and the huge macromolecular aggregates they often form, they occupy a **large volume** of the matrix relative to proteins.

Various Glycosaminoglycans Exhibit Differences in Structure & Have Characteristic Distributions and Diverse Functions

The seven GAGs named above differ from each other in a number of the following properties: amino sugar composition, uronic acid composition, linkages between these components, chain length of the disaccharides, the presence or absence of sulfate groups and their positions of attachment to the constituent sugars, the nature of the core proteins to which they are attached, the nature of the linkage to core protein, their tissue and subcellular distribution, and their biologic functions.

The structure (**Figure 50–10**) distribution and functions of each of the GAGs will now be briefly discussed. The major features of the seven GAGs are summarized in **Table 50–6**.

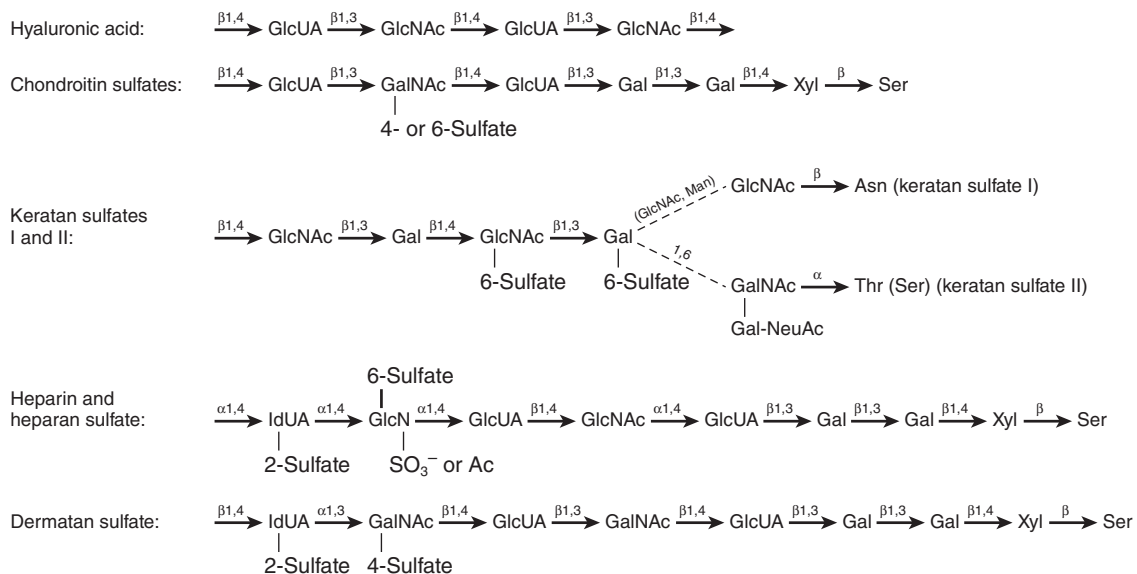

FIGURE 50–10 Structures of glycosaminoglycans and their attachments to core proteins. (Ac, acetyl; Asn, L-asparagine; Gal, D-galactose; GalN, D-galactosamine; GlcN, D-glucosamine; GlcUA, D-glucuronic acid; IdUA, L-iduronic acid; Man, D-mannose; NeuAc, N-acetylneuraminic acid; Ser, L-serine; Thr, L-threonine; Xyl, L-xylose.) The summary structures are qualitative representations only and do not reflect, for example, the uronic acid composition of hybrid glycosaminoglycans such as heparin and dermatan sulfate, which contain both L-iduronic and D-glucuronic acid. Neither should it be assumed that the indicated substituents are always present, for example, whereas most iduronic acid residues in heparin carry a 2'-sulfate group, a much smaller proportion of these residues are sulfated in dermatan sulfate. The presence of link trisaccharides (Gal-GalXyl) in the chondroitin sulfates, heparin, and heparin, and dermatan sulfates is shown. (Slightly modified and reproduced, with permission, from Lennarz WJ: *The Biochemistry of Glycoproteins and Proteoglycans*. Plenum Press, 1980. Reproduced with kind permission from Springer Science and Business Media.)

TABLE 50–6 Properties of Glycosaminoglycans

GAG	Sugars	Sulfate ^a	Protein Linkage	Location
Hyaluronic acid	GlcNAc, GlcUA	-	None	Skin, synovial fluid, bone, cartilage, vitreous humor, embryonic tissues
Chondroitin sulfate	GalNAc, GlcUA	GalNAc	Xyl-Ser; associated with HA via link proteins	Cartilage, bone, CNS
Keratan sulfate I and II	GlcNAc, Gal	GlcNAc	GlcNAc-Asn (KS I) GalNAc-Thr (KS II)	Cornea, cartilage, loose connective tissue
Heparin	Gln, IdUA	GlcN GlcN IdUA	Ser	Mast cells, liver, lung, skin
Heparan sulfate	GlcN, GlcUA	GlcN	Xyl-Ser	Skin, kidney basement membrane
Dermatan sulfate	GalNAc, IdUA, (GlcUA)	GalNAc IdUA	Xyl-Ser	Skin, wide distribution

^aThe sulfate is attached to various positions of the sugars indicated (see Figure 50–10). Note that all GAGs except the keratan sulfates contain a uronic acid which may be glucuronic or iduronic acid.

Hyaluronic Acid

Hyaluronic acid consists of an unbranched chain of repeating disaccharide units containing GlcUA and GlcNAc. It is present in bacteria and is found in the ECM of nearly all animal tissues, but is especially high in concentration in highly hydrated types such as skin and umbilical cord, and in bone, cartilage, joints (synovial fluid) and in vitreous humor in the eye, as well as in embryonic tissues. It is thought to play an important role in permitting **cell migration** during morphogenesis and wound repair. Its ability to attract water into the ECM triggers loosening of the matrix, aiding this process. The high concentrations of hyaluronic acid together with chondroitin sulfates present in **cartilage** contribute to its compressibility (see below).

Chondroitin Sulfates (Chondroitin 4-Sulfate & Chondroitin 6-Sulfate)

Proteoglycans linked to **chondroitin sulfate** by the Xyl-Ser O-glycosidic bond are prominent components of **cartilage** (see below). The repeating disaccharide is similar to that found in hyaluronic acid, containing GlcUA but with **GalNAc** replacing GlcNAc. The GalNAc is substituted with **sulfate** at either its 4' or its 6' position, with approximately one sulfate being present per disaccharide unit. Chondroitin sulfates have an important role in maintaining the structure of the ECM. They are located at sites of calcification in endochondral **bone** and are a major component of **cartilage**. They are found in high amounts in the ECM of the central nervous system and, in addition to their structural function, are thought to act as signaling molecules in the prevention of the repair of nerve endings after injury.

Keratan Sulfates I & II

As shown in Figure 50–10, the keratan sulfates consist of repeating **Gal-GlcNAc** disaccharide units containing **sulfate** attached to the 6' position of GlcNAc or occasionally of Gal.

Keratan sulfate I was originally isolated from the **cornea**, while **keratan sulfate II** came from cartilage. However, the two GAGs differ in the structural links to the core proteins, and since it is now known that the distribution of the two types is not tissue specific the classification is based on the different protein linkage. In the eye, they lie between collagen fibrils and play a critical role in corneal transparency. Changes in proteoglycan composition found in corneal scars disappear when the cornea heals.

Heparin

The repeating disaccharide **heparin** contains **glucosamine** (GlcN) and either of the two uronic acids (**Figure 50–11**). Most of the amino groups of the GlcN residues are **N-sulfated**, but a few are acetylated. The GlcN also carries a sulfate attached to carbon 6.

The vast majority of the uronic acid residues are **IdUA**. Initially, all of the uronic acids are GlcUA, but a 5'-epimerase converts approximately 90% of the GlcUA residues to IdUA after the polysaccharide chain is formed. The protein molecule of the heparin proteoglycan is unique, consisting exclusively of serine and glycine residues. Approximately two-thirds of the serine residues contain GAG chains, usually of 5 to 15 kDa but occasionally much larger. Heparin is found in the granules of **mast cells** and also in liver, lung, and skin. It is an important **anticoagulant**. It binds with factors IX and XI, but its most important interaction is with **plasma antithrombin** (discussed in Chapter 55). Heparin can also bind specifically to **lipoprotein lipase** present in capillary walls, causing a release of this enzyme into the circulation.

Heparan Sulfate

This molecule is present on many **cell surfaces** as a proteoglycan and is extracellular. It contains **GlcN** with fewer N-sulfates than heparin, and, unlike heparin, its predominant uronic

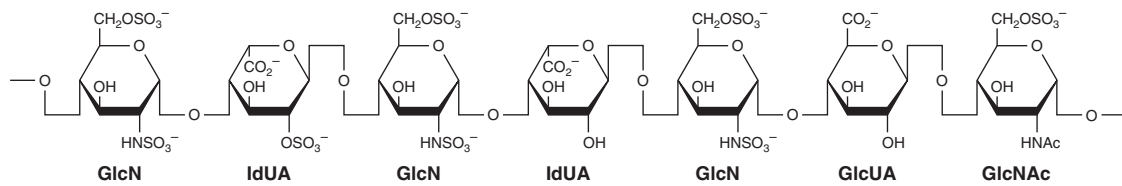

FIGURE 50-11 Structure of heparin. The polymer section illustrates structural features typical of heparin; however, the sequence of variously substituted repeating disaccharide units has been arbitrarily selected. In addition, non-*O*-sulfated or 3-*O*-sulfated glucosamine residues may also occur. (Modified, redrawn, and reproduced, with permission, from Lindahl U, et al: Structure and biosynthesis of heparin-like polysaccharides. *Fed Proc* 1977;36:19.)

acid is **GlcUA**. **Heparan sulfate** is associated with the plasma membrane of cells, with their core proteins actually spanning that membrane. In this, they may act as **receptors** and may also participate in the mediation of the **cell growth** and **cell-cell communication**. The attachment of cells to their substratum in culture is mediated at least in part by heparan sulfate. This proteoglycan is also found in the **basement membrane of the kidney** along with type IV collagen and laminin (see above), where it plays a major role in determining the charge selectiveness of glomerular filtration.

Dermatan Sulfate

This substance is widely distributed in animal tissues. Its structure is similar to that of chondroitin sulfate, except that in place of a GlcUA in β -1,3 linkage to GalNAc it contains an **IdUA** in an α -1,3 linkage to **GalNAc**. Formation of the IdUA occurs, as in heparin and heparan sulfate, by 5'-epimerization of GlcUA. Because this is regulated by the degree of sulfation and because sulfation is incomplete, dermatan sulfate contains **both** IdUA-GalNAc and GlcUA-GalNAc disaccharides. **Dermatan sulfate** has a widespread distribution in tissues, and is the main GAG in skin. Evidence suggests it may play a part in blood coagulation, wound repair and resistance to infection.

Proteoglycans are also found in **intracellular locations** such as the nucleus; their function in this organelle has not been elucidated. They are present in some storage or secretory granules, such as the chromaffin granules of the adrenal medulla. It has been postulated that they play a role in release of the contents of such granules. The various functions of GAGs are summarized in **Table 50-7**.

Deficiencies of Enzymes That Degrade Glycosaminoglycans Result in Mucopolysaccharidoses

Both **exo-** and **endoglycosidases** degrade GAGs. Like most other biomolecules, GAGs are subject to **turnover**, being both synthesized and degraded. In adult tissues, GAGs generally exhibit relatively **slow** turnover, their half-lives being days to weeks.

Understanding of the degradative pathways for GAGs, as in the case of glycoproteins (see Chapter 46) and glycosphingolipids (see Chapter 24), has been greatly aided by elucidation of

the specific enzyme deficiencies that occur in certain **inborn errors of metabolism**. When GAGs are involved, these inborn errors are called **mucopolysaccharidoses** (**Table 50-8**).

Degradation of GAGs is carried out by a battery of **lysosomal hydrolases**. These include **endoglycosidases**, **exoglycosidases**, and **sulfatases**, generally acting in sequence to degrade the various GAGs. A number of them are indicated in **Table 50-8**.

The **mucopolysaccharidoses (MPSs)** (**Table 50-8**) share a common mechanism of causation, as illustrated in **Figure 50-12**. They are usually inherited in an **autosomal recessive** manner, with **Hurler** and **Hunter syndromes** being perhaps the most widely studied. None is common. In general, these conditions are chronic and progressive and affect multiple organs. Many patients exhibit organomegaly (eg, hepato- and splenomegaly; severe abnormalities in the development of cartilage and bone; abnormal facial appearance; and mental retardation. In addition, defects in hearing, vision and the cardiovascular system may be present. Diagnostic tests include analysis of GAGs in

TABLE 50-7 Some Functions of Glycosaminoglycans and Proteoglycans

• Act as structural components Components of the ECM
• Have specific interactions with collagen, elastin, fibronectin, laminin, and other proteins such as growth factors
• As polyanions, bind polycations and cations
• Contribute to the characteristic turgor of various tissues
• Act as sieves in the ECM
• Facilitate cell migration (HA)
• Have role in compressibility of cartilage in weight-bearing (HA,CS)
• Play role in corneal transparency (KS I and DS)
• Have structural role in sclera (DS)
• Act as anticoagulant (heparin)
• Are components of plasma membranes, where they may act as receptors and participate in cell adhesion and cell-cell interactions (eg, HS)
• Determine charge selectiveness of renal glomerulus (HS)
• Are components of synaptic and other vesicles (eg, HS)

Abbreviations: CS, chondroitin sulfate; DS, dermatan sulfate; ECM, extracellular matrix; HA, hyaluronic acid; HS, heparan sulfate; KS I, keratan sulfate I.

TABLE 50-8 The Mucopolysaccharidoses

Disease Name	Abbreviation ^a	Enzyme Defective	GAG(s) Affected	Symptoms
Hurler-, Scheie-Hurler-Scheie syndrome	MPS I	α -L-Iduronidase	Dermatan sulfate, heparan sulfate	Mental retardation, coarse facial features, hepatosplenomegaly, cloudy cornea
Hunter syndrome	MPS II	Iduronate sulfatase	Dermatan sulfate, heparan sulfate	Mental retardation
Sanfilippo syndrome A	MPS IIIA	Heparan sulfate-N-sulfatase ^b	Heparan sulfate	Delay in development, motor dysfunction
Sanfilippo syndrome B	MPS IIIB	α -N-Acetylglucosaminidase	Heparan sulfate	As MPS IIIA
Sanfilippo syndrome C	MPS IIIC	α -Glucosaminide N-acetyltransferase	Heparan sulfate	As MPS IIIA
Sanfilippo syndrome D	MPS IIID	N-Acetylglucosamine 6-sulfatase	Heparan sulfate	As MPS IIIA
Morquio syndrome A	MPS IVA	Galactosamine 6-sulfatase	Keratan sulfate, chondroitin 6-sulfate	Skeletal dysplasia, short stature
Morquio syndrome B	MPS IVB	β -Galactosidase	Keratan sulfate	As MPS IVA
Maroteaux-Lamy syndrome	MPS VI	N-Acetylgalactosamine 4-sulfatase ^c	Dermatan sulfate	Curvature of the spine, short stature, skeletal dysplasia, cardiac defects
Sly syndrome	MPS VII	β -Glucuronidase	Dermatan sulfate, heparan sulfate, chondroitin 4-sulfate, chondroitin 6-sulfate	Skeletal dysplasia, short stature, hepatomegaly, cloudy cornea
Natowicz syndrome	MPS IX	Hyaluronidase	Hyaluronic acid	Joint pain, short stature

^aThe terms MPS V and MPS VIII are no longer used.

^bAlso called sulfaminidase.

^cAlso called arylsulfatase B.

urine or tissue biopsy samples; assay of suspected defective enzymes in white blood cells, fibroblasts or serum; and test for specific genes. Prenatal diagnosis is now sometimes possible using amniotic fluid cells or chorionic villus biopsy samples. In some cases, a **family history** of a mucopolysaccharidosis is obtained.

The term “**mucopolipidosis**” was introduced to denote diseases that combined features common to both mucopolysaccharidoses and sphingolipidoses (see Chapter 24). In **sialidosis**

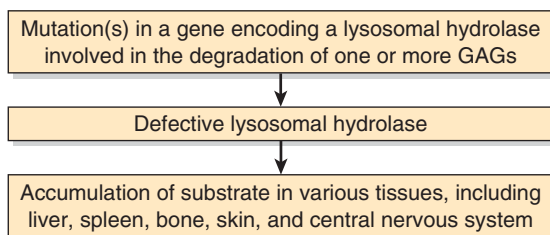

FIGURE 50-12 Simplified scheme of causation of a mucopolysaccharidosis, such as the Hurler syndrome. Marked accumulation of the GAGs in the tissues mentioned in the figure could cause hepatomegaly, splenomegaly, disturbances of growth, coarse facial features, and mental retardation.

(mucopolipidosis I, ML-I), various oligosaccharides derived from glycoproteins and certain gangliosides accumulate in tissues. **I-cell disease** (ML-II) and **pseudo-Hurler polydystrophy** (MLIII) are described in Chapter 46. The term “mucopolipidosis” is retained because it is still in relatively widespread clinical usage, but it is not appropriate for these two latter diseases since the mechanism of their causation involves **mislocation** of certain lysosomal enzymes. Genetic defects of the catabolism of the oligosaccharide chains of glycoproteins (eg, mannosidosis, fucosidosis) are also described in Chapter 46. Most of these defects are characterized by increased excretion of various fragments of glycoproteins in the urine, which accumulate because of the metabolic block, as in the case of the mucopolipidoses.

Hyaluronidase is one important enzyme involved in the catabolism of both hyaluronic acid and chondroitin sulfate. It is a widely distributed endoglycosidase that cleaves hexosaminidic linkages. From hyaluronic acid, the enzyme will generate a tetrasaccharide with the structure $(\text{GlcUA}\beta\text{-1,3-GlcNAc}\beta\text{-1,4})_2$, which can be degraded further by a β -glucuronidase and β -N-acetylhexosaminidase. A genetic defect in hyaluronidase causes MPS IX, a lysosomal storage disorder in which hyaluronic acid accumulates in the joints.

Proteoglycans Are Associated With Major Diseases & With Aging

Hyaluronic acid may be important in permitting **tumor cells to migrate** through the ECM. Tumor cells can induce fibroblasts to synthesize greatly increased amounts of this GAG, thereby perhaps facilitating their own spread. Some tumor cells have less heparan sulfate at their surfaces, and this may play a role in the **lack of adhesiveness** that these cells display.

The intima of the **arterial wall** contains hyaluronic acid and chondroitin sulfate, dermatan sulfate, and heparan sulfate proteoglycans. Of these proteoglycans, dermatan sulfate binds plasma low-density lipoproteins. In addition, dermatan sulfate appears to be the major GAG synthesized by arterial smooth muscle cells. Because it is these cells that proliferate in **atherosclerotic lesions** in arteries, dermatan sulfate may play an important role in development of the atherosclerotic plaque.

In various types of **arthritis**, proteoglycans may act as **autoantigens**, thus contributing to the pathologic features of these conditions. The amount of chondroitin sulfate in cartilage diminishes with age, whereas the amounts of keratan sulfate and hyaluronic acid increase. These changes may contribute to the development of **osteoarthritis**, as may increased activity of the enzyme aggrecanase, which acts to degrade aggrecan. Changes in the amounts of certain GAGs in the skin are also observed with **aging** and help to account for the characteristic changes noted in this organ in the elderly.

In the past few years it has become clear that in addition to their structural role in the ECM, proteoglycans function as signaling molecules which influence cell behavior, and they are now believed to play a part in diverse diseases such as fibrosis, cardiovascular disease and cancer.

BONE IS A MINERALIZED CONNECTIVE TISSUE

Bone contains both **organic** and **inorganic** material. The **organic** matter is mainly **protein**. The principal proteins of bone are listed in **Table 50-9**; **type I collagen** is the major protein, comprising 90% to 95% of the organic material. Type V collagen is also present in small amounts, as are a number of noncollagen proteins, some of which are relatively specific to bone. The **inorganic** or mineral component is mainly crystalline **hydroxyapatite**— $\text{Ca}_{10}(\text{PO}_4)_6(\text{OH})_2$ —along with sodium, magnesium, carbonate, and fluoride; approximately 99% of the body's calcium is contained in bone (see Chapter 44). Hydroxyapatite confers on bone the strength and resilience required for its physiologic roles.

Bone is a **dynamic structure** that undergoes continuing cycles of remodeling, consisting of resorption followed by deposition of new bone tissue. This remodeling permits bone to adapt to both physical (eg, increases in weight bearing) and hormonal signals.

The major cell types involved in bone resorption and deposition are **osteoclasts** and **osteoblasts**, respectively

TABLE 50-9 The Principal Proteins Found in Bone^a

Proteins	Comments
Collagens	
Collagen type I	Approximately 90% of total bone protein. Composed of two $\alpha 1(I)$ and one $\alpha 2(I)$ chains.
Collagen type V	Minor component.
Noncollagen proteins	
Plasma proteins	Mixture of various plasma proteins.
Proteoglycans ^b CS-PG I (biglycan)	Contains two GAG chains; found in other tissues.
CS-PG II (decorin)	Contains one GAG chain; found in other tissues.
CS-PG III	Bone-specific.
Bone SPARC ^c protein (osteonectin)	Not bone-specific.
Osteocalcin (bone Gla protein)	Contains γ -carboxyglutamate (Gla) residues that bind to hydroxyapatite. Bone-specific.
Osteopontin	Not bone-specific. Glycosylated and phosphorylated.
Bone sialoprotein	Bone-specific. Heavily glycosylated, and sulfated on tyrosine.
Bone morphogenetic proteins (BMPs)	A family (eight or more) of secreted proteins with a variety of actions on bone; many induce ectopic bone growth.
Osteoprotegerin	Inhibits osteoclastogenesis

^aVarious functions have been ascribed to the noncollagen proteins, including roles in mineralization; however, most of them are still speculative. It is considered unlikely that the noncollagen proteins that are not bone-specific play a key role in mineralization. A number of other proteins are also present in bone, including a tyrosine-rich acidic matrix protein (TRAMP), some growth factors (eg, TGF β), and enzymes involved in collagen synthesis (eg, lysyl oxidase).

^bCS-PG, chondroitin sulfate–proteoglycan; these are similar to the dermatan sulfate PGs (DS-PGs) of cartilage (TABLE 50-9).

^cSPARC, secreted protein acidic and rich in cysteine.

(**Figure 50-13**). **Osteocytes** are found in mature bone and are also involved in the maintenance of the bone matrix. They are descended from osteoblasts and are very long-lived, with an average half life of 25 years.

Osteoclasts are multinucleated cells derived from pluripotent hematopoietic stem cells. Osteoclasts possess an apical membrane domain, exhibiting a ruffled border that plays a key role in bone resorption (**Figure 50-14**). A special proton-translocating **ATPase** expels protons across the ruffled border into the resorption area, which is the microenvironment of low pH shown in the figure. This lowers the local pH to 4.0 or less, thus increasing the solubility of hydroxyapatite and helping its breakdown into Ca^{2+} , H_3PO_4 and H_2CO_3 and water, thus allowing demineralization to occur. Lysosomal acid proteases

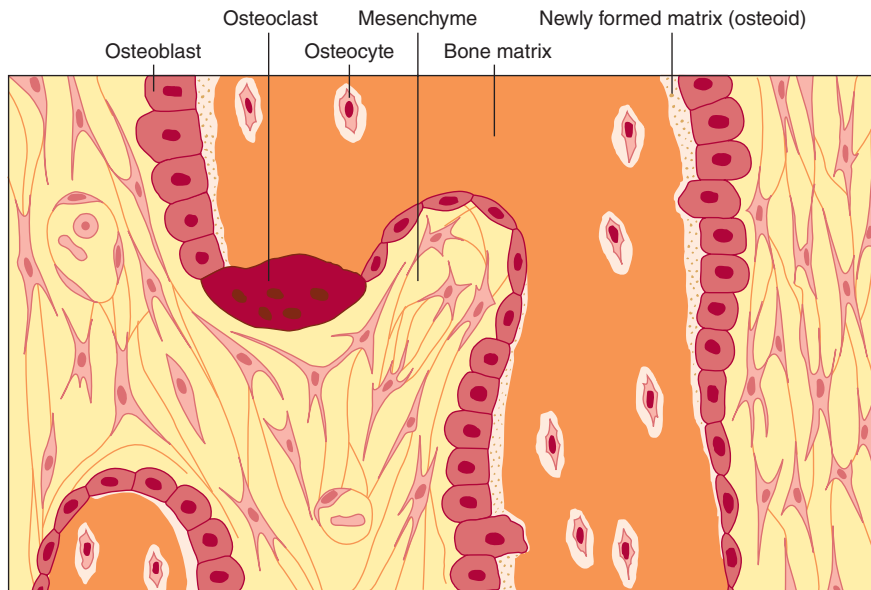

FIGURE 50-13 Schematic illustration of the major cells present in the membranous bone. Osteoblasts (lighter color) are synthesizing type I collagen, which forms a matrix that traps cells. As this occurs, osteoblasts gradually differentiate to become osteocytes. (Reproduced, with permission, from Junqueira LC, Carneiro J: *Basic Histology: Text & Atlas*, 10th ed. McGraw-Hill, 2003.)

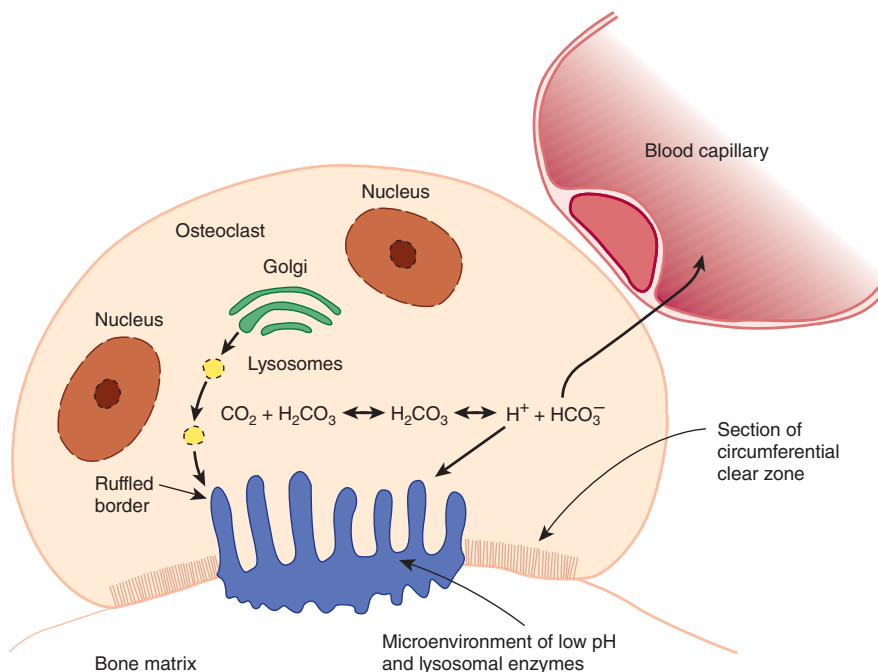

FIGURE 50-14 Schematic illustration of the role of the osteoclast in bone resorption. Lysosomal enzymes and hydrogen ions are released into the confined microenvironment created by the attachment between the bone matrix and the peripheral clear zone of the osteoclast. The acidification of this confined space facilitates the dissolution of calcium phosphate from bone and is the optimal pH for the activity of lysosomal hydrolases. The bone matrix is thus removed, and the products of bone resorption are taken up into the cytoplasm of the osteoclast, probably digested further, and transferred into capillaries. The chemical equation shown refers to the action of carbonic anhydrase II, described in the text. (Reproduced, with permission, from Junqueira LC, Carneiro J: *Basic Histology: Text & Atlas*, 10th ed. McGraw-Hill, 2003.)

such as cathepsins are also released to digest the now accessible matrix proteins. **Osteoblasts**—mononuclear cells derived from pluripotent mesenchymal precursors—synthesize most of the proteins found in bone (Table 50–9) as well as various growth factors and cytokines. They are responsible for the deposition of the new bone matrix (osteoid) and its subsequent mineralization. Osteoblasts **control mineralization** by regulating the passage of calcium and phosphate ions across their surface membranes, **Alkaline phosphatase**, an enzyme in the cell membrane, generates phosphate ions from organic phosphates. The mechanisms involved in mineralization are not fully understood, but several factors have been implicated. Alkaline phosphatase contributes to mineralization, but in itself is not sufficient. Small vesicles (matrix vesicles) containing calcium and phosphate are formed by budding from the osteoblast membrane are also believed to play a role. In addition, **type I collagen** appears to be necessary, with mineralization being first evident in the gaps between successive molecules. **Acidic phosphoproteins**, such as **bone sialoprotein and osteopontin**, may act as sites of nucleation. These proteins contain RGD sequences for cell attachment and motifs (eg, poly-Asp and poly-Glu stretches) that bind calcium and may provide an initial scaffold for mineralization. Some macromolecules, such as certain proteoglycans and glycoproteins, can also act as **inhibitors** of nucleation.

It is estimated that approximately 4% of compact bone is **renewed annually** in the typical healthy adult, whereas approximately 20% of trabecular bone (less dense bone found at the ends of long bones close to joints) is replaced.

Many factors are involved in the **regulation of bone metabolism**. Some **stimulate osteoblasts** (eg, parathyroid hormone and 1,25-dihydroxycholecalciferol [see Chapter 44]) and others **inhibit** them (eg, corticosteroids). Parathyroid hormone and 1,25-dihydroxycholecalciferol also stimulate osteoclasts, whereas calcitonin and estrogens inhibit them.

BONE IS AFFECTED BY MANY METABOLIC & GENETIC DISORDERS

A number of the more important examples of metabolic and genetic disorders that affect bone are listed in **Table 50–10**.

Osteogenesis imperfecta (brittle bones) is characterized by abnormal fragility of bones. The scleras are often abnormally thin and translucent and may appear blue owing to a deficiency of connective tissue. **Eight types** (I–VIII) of this condition have been recognized. Types I to IV are caused by mutations in the *COL1A1* or *COL1A2* genes or both. Type I is mild, but type II is severe and infants born with the condition usually do not survive. Over 100 mutations in these two genes have been documented and include partial gene deletions and duplications. Other mutations affect RNA splicing, and the most frequent type results in the **replacement of glycine** by another bulkier amino acid, affecting formation of the triple helix. In general, these mutations result in decreased expression of collagen or in structurally abnormal pro chains that assemble into **abnormal fibrils**, weakening the overall structure of bone. When one abnormal chain is present, it may interact with two normal chains, but folding may be prevented, resulting in enzymatic degradation of all of the chains. This is called “**procollagen suicide**” and is an example of a dominant negative mutation, a result often seen when a protein consists of multiple different subunits. Types V to VIII are less common and are caused by mutations in the genes for proteins involved in bone mineralization other than collagen.

Osteopetrosis (marble bone disease), characterized by **increased bone density**, is a rare condition characterized by inability to resorb bone. One form occurs along with renal tubular acidosis and cerebral calcification. It is due to mutations in the gene (located on chromosome 8q22) encoding

TABLE 50–10 Some Metabolic and Genetic Diseases Affecting Bone and Cartilage

Condition	Causes	Condition	Causes
Dwarfism	Often deficiency of growth hormone, but many other causes	Osteoporosis	Age-related, estrogen deficiency following menopause, mutations in genes affecting bone metabolism, ^a including the vitamin D receptor (<i>VDR</i>), estrogen receptor- α (<i>ER-α</i>) and <i>COL1A1</i>
Rickets	Deficiency of vitamin D in childhood	Osteoarthritis	Age-related cartilage degeneration, mutations in various genes ^a including <i>VDR</i> , <i>ER-α</i> and <i>COL2A1</i>
Osteomalacia	Deficiency of vitamin D in adults	Chondrodysplasias	Mutations in <i>COL2A1</i>
Hyperparathyroidism	Excess parathyroid hormone causing bone resorption	Pfeiffer, Jackson-Weiss and Crouzon syndromes ^b	Mutations in the gene for fibroblast growth receptor (<i>FGFR</i>) 1 and/or 2
Osteogenesis imperfecta	Mutations in <i>COL1A1</i> and <i>COL1A2</i> affecting the synthesis and structure of collagen	Achondroplasia and thanatophoric dysplasia ^c	Mutation in the gene for <i>FGFR3</i>

^aOnly a small number of cases.

^bIn the Pfeiffer, Jackson-Weiss, and Crouzon syndromes there is premature fusion of some bones in the skull (craniosynostosis).

^cThanatophoric dysplasia is the most common neonatal lethal skeletal dysplasia.

carbonic anhydrase II (CA II), one of four isozymes of carbonic anhydrase present in human tissues. The reaction catalyzed by carbonic anhydrase is



In osteoclasts involved in bone resorption, CA II apparently provides protons to neutralize the OH^- ions left inside the cell when H^+ ions are pumped across their ruffled borders (see above). Thus, **if CA II is deficient in activity** in osteoclasts, normal bone resorption does not occur, and osteopetrosis results. The mechanism of the cerebral calcification is not clear, whereas the renal tubular acidosis reflects deficient activity of CA II in the renal tubules.

Osteoporosis is a generalized progressive reduction in bone tissue mass per unit volume causing skeletal weakness. The primary type 1 condition commonly occurs in women after the menopause, while primary type 2 or senile osteoporosis occurs in both sexes post 75 years, although is more prevalent in women (ratio 2:1 female:male). The ratio of **mineral to organic elements** is unchanged in the remaining normal bone. Fractures of various bones, such as the head of the femur, occur very easily and represent a huge burden to both the affected patients and to the health care budget of society. Among other factors, **estrogens** and the cytokines **interleukins-1 and -6** appear to be intimately involved in the causation of osteoporosis.

THE MAJOR COMPONENTS OF CARTILAGE ARE TYPE II COLLAGEN & CERTAIN PROTEOGLYCAN

The **principal proteins** of **hyaline cartilage** (the major type of cartilage) are listed in **Table 50–11**. **Type II collagen** is the principal protein (**Figure 50–15**), and a number of other minor types of collagen are also present. In addition to these components, elastic cartilage contains elastin, and fibroelastic cartilage contains type I collagen. Cartilage contains a number of **proteoglycans**, which play an important role in its compressibility. **Aggrecan** (about 2×10^3 kDa) is the major proteoglycan. As shown in **Figure 50–16**, it has a very complex structure, containing several GAGs (hyaluronic acid, chondroitin sulfate, and keratan sulfate) and both link and core proteins. The core protein contains three domains: A, B, and C. The hyaluronic acid binds noncovalently to domain A of the core protein as well as to the link protein, which stabilizes the hyaluronate–core protein interactions. The keratan sulfate chains are located in domain B, whereas the chondroitin sulfate chains are located in domain C; both of these types of GAGs are bound covalently to the core protein. The core protein also contains both O- and N-linked oligosaccharide chains.

The other proteoglycans found in cartilage have simpler structures than aggrecan.

Chondronectin is involved in the attachment of type II collagen to chondrocytes (the cells in cartilage).

TABLE 50–11 The Principal Proteins Found in Cartilage

Proteins	Comments
Collagen proteins	
Collagen type II	90%–98% of total articular cartilage collagen. Composed of three α 1(II) chains.
Collagens V, VI, IX, X, XI	Type IX cross-links to type II collagen. Type XI may help control diameter of type II fibrils.
Noncollagen proteins	
Proteoglycans	The major proteoglycan of cartilage.
Aggrecan	Found in some types of cartilage.
Large nonaggregating proteoglycan DS-PG I (biglycan) ^a DS-PG II (decorin)	Similar to CS-PG I of bone. Similar to CS-PG II of bone.
Chondronectin	May play role in binding type II collagen to surface of cartilage.
Anchorin C II	May bind type II collagen to surface of chondrocyte.

^aThe core proteins of DS-PG I and DS-PG II are homologous to those of CS-PG I and CS-PG II found in bone (TABLE 50–11). A possible explanation is that osteoblast-lack the epimerase required to convert glucuronic acid to iduronic acid, the latter of which is found in dermatan sulfate.

Cartilage is an avascular tissue and obtains most of its nutrients from synovial fluid. It exhibits slow but continuous **turnover**. Various **proteases** (eg, collagenases and stromelysin) synthesized by chondrocytes can **degrade collagen** and the other proteins found in cartilage. Interleukin-1 (IL-1) and tumor necrosis factor α (TNF α) appear to stimulate the production of such proteases, whereas transforming growth factor β (TGF β) and insulin-like growth factor 1 (IGF-I) generally exert an anabolic influence on the cartilage.

CHONDRODYSPLASIAS ARE CAUSED BY MUTATIONS IN GENES ENCODING TYPE II COLLAGEN & FIBROBLAST GROWTH FACTOR RECEPTORS

Chondrodysplasias are a mixed group of hereditary disorders affecting cartilage. They are manifested by short-limbed dwarfism and numerous skeletal deformities. A number of them are due to a variety of mutations in the *COL2A1* gene, leading to abnormal forms of type II collagen. One example is the **Stickler syndrome**, manifested by degeneration of the joint cartilage and of the vitreous body of the eye.

The best known of the chondrodysplasias is **achondroplasia**, the most common cause of **short-limbed dwarfism**. Affected individuals have short limbs, normal trunk size, macrocephaly, and a variety of other skeletal abnormalities.

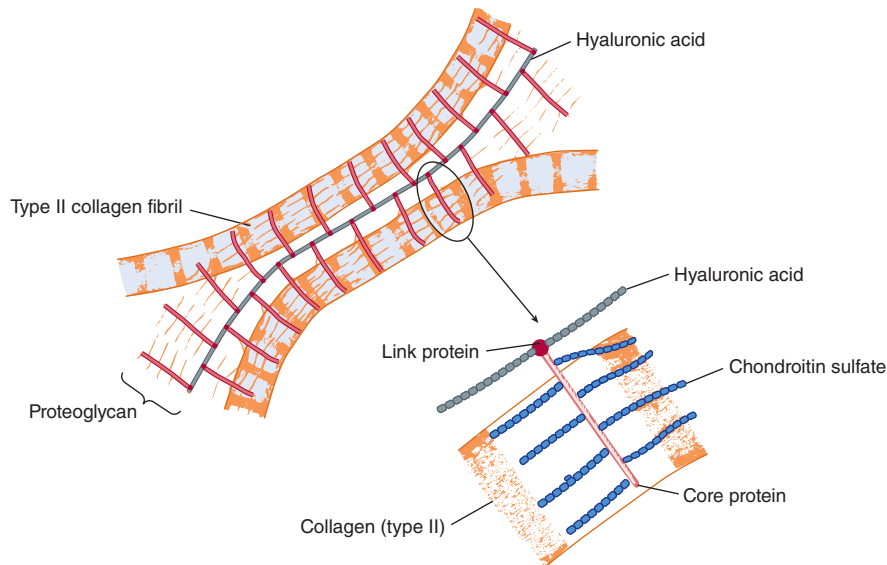

FIGURE 50-15 Schematic representation of the molecular organization in the cartilage matrix. Link proteins noncovalently bind the core protein (red) of proteoglycans to the linear hyaluronic acid molecules (gray). The chondroitin sulfate side chains of the proteoglycan electrostatically bind to the collagen fibrils, forming a cross-linked matrix. The oval outlines the area enlarged in the lower part of the figure. (Reproduced, with permission, from Junqueira LC, Carneiro J: *Basic Histology: Text & Atlas*, 10th ed. McGraw-Hill, 2003.)

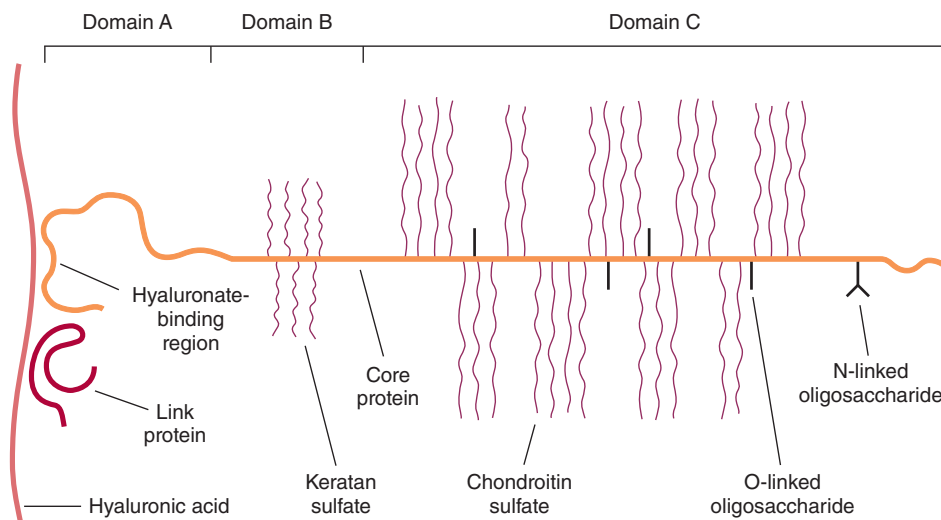

FIGURE 50-16 Schematic diagram of the aggrecan from bovine nasal cartilage. A strand of hyaluronic acid is shown on the left. The core protein (about 210 kDa) has three major domains. Domain A, at its amino terminal end, interacts with approximately five repeating disaccharides in hyaluronate. The link protein interacts with both hyaluronate and domain A, stabilizing their interactions. Approximately 30 keratan sulfate chains are attached, via GalNAc-Ser linkages, to domain B. Domain C contains about 100 chondroitin sulfate chains attached via Gal-Gal-Xyl-Ser linkages and about 40 O-linked oligosaccharide chains. One or more N-linked glycan chains are also found near the carboxyl terminal of the core protein. (Moran LA, et al: *Biochemistry*, 2nd ed., © 1994, pp. 9–43. Adapted by permission of Pearson Education, Inc., Upper Saddle River, NJ.)

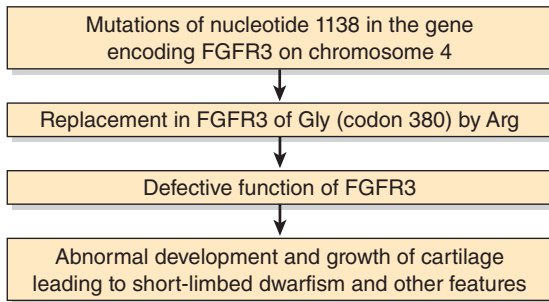

FIGURE 50–17 Simplified scheme of the causation of achondroplasia. In most cases studied so far, the mutation has been a G to A transition at nucleotide 1138, resulting in replacement of a Gly residue by an Arg residue in the transmembrane segment of the receptor.

The condition is often inherited as an autosomal dominant trait, but many cases are due to new mutations. The molecular basis of achondroplasia is outlined in **Figure 50–17**. Achondroplasia is not a collagen disorder but is due to mutations in the gene encoding **fibroblast growth factor receptor 3 (FGFR3)**. **Fibroblast growth factors** are a family of more than 20 proteins that affect the growth and differentiation of cells of mesenchymal and neuroectodermal origin. Their **receptors** are transmembrane proteins and form a subgroup of four in the family of receptor tyrosine kinases. FGFR3 is one member of this subgroup and mediates the actions of FGF3 on cartilage. In almost all cases of achondroplasia that have been investigated, the mutations were found to involve nucleotide 1138 and resulted in substitution of arginine for glycine (residue number 380) in the transmembrane domain of the protein, rendering it inactive. No such mutation was found in unaffected individuals.

Rather amazingly, other mutations in the same gene can result in **hypochondroplasia**, **thanatophoric dysplasia** (types I and II) (other forms of short-limbed dwarfism) and the **SADDAN phenotype** (severe achondroplasia with developmental delay and acanthosis nigricans [the latter is a brown to black hyperpigmentation of the skin]).

As indicated in Table 50–10, **other skeletal dysplasias** (including certain craniosynostosis syndromes) are also due to mutations in genes encoding FGF receptors. Another type of skeletal dysplasia, **diastrophic dysplasia** has been found to be due to mutation in a sulfate transporter.

SUMMARY

- The major components of the ECM are the structural proteins collagen, elastin, and fibrillin-1, a number of specialized proteins (eg, fibronectin and laminin), and various proteoglycans.
- Collagen is the most abundant protein in the animal kingdom; approximately 28 types have been isolated. All collagens contain greater or lesser stretches of triple helix and the repeating structure (Gly-X-Y)*n*.

- The biosynthesis of collagen is complex, featuring many posttranslational events, including hydroxylation of proline and lysine.
- Diseases associated with impaired synthesis of collagen include scurvy, osteogenesis imperfecta, Ehlers-Danlos syndrome (six subtypes), and Menkes disease.
- Elastin confers extensibility and elastic recoil on tissues. Elastin lacks hydroxylysine, Gly-X-Y sequences, triple helical structure, and sugars, but contains desmosine and isodesmosine cross-links not found in collagen.
- Fibrillin-1 is located in microfibrils. Mutations in the gene encoding fibrillin-1 cause Marfan syndrome. The cytokine TGF- β appears to contribute to the cardiovascular pathology.
- The glycosaminoglycans (GAGs) are made up of repeating disaccharides containing a uronic acid (glucuronic or iduronic) or hexose (galactose) and a hexosamine (galactosamine or glucosamine). Sulfate is also frequently present.
- The major GAGs are hyaluronic acid, chondroitin 4- and 6-sulfates, keratan sulfates I and II, heparin, heparan sulfate, and dermatan sulfate.
- The GAGs are synthesized by the sequential actions of a battery of specific enzymes (glycosyltransferases, epimerases, sulfotransferases, etc) and are degraded by the sequential action of lysosomal hydrolases. Genetic deficiencies of the latter result in mucopolysaccharidoses (eg, the Hurler syndrome).
- GAGs occur in tissues bound to various proteins (linker proteins and core proteins), constituting proteoglycans. These structures are often of very high molecular weight and serve many functions in tissues.
- Many components of the ECM bind to proteins of the cell surface named integrins; this constitutes one pathway by which the exterior of cells can communicate with their interior.
- Bone and cartilage are specialized forms of the ECM. Collagen I and hydroxyapatite are the major constituents of bone. Collagen II and certain proteoglycans are major constituents of cartilage.
- A number of heritable diseases of bone (eg, osteogenesis imperfecta) and of cartilage (eg, the chondrodysplasias) are caused by mutations in the genes for collagen and proteins involved in bone mineralization and cartilage formation.

REFERENCES

- Baldrige D, Shchelochkov O, Kelley B, Lee B: Signaling pathways in human skeletal dysplasias. *Annu Rev Genomics Human Genet* 2010;11:189.
- Couchman JR: Transmembrane signaling proteoglycans. *Annu Rev Cell Develop Biol* 2010;26:89.
- Fauci AS, Braunwald E, Kasper DL, et al: *Harrison's Principles of Internal Medicine*, 17th ed. McGrawHill, 2008. (Chapter 357, Heritable Disorders of Connective Tissue; Chapter 355, Lysosomal Storage Diseases; Chapter 326, Osteoarthritis; Chapter 346, Bone and Mineral Metabolism in Health and Disease; Chapter 349, Paget Disease and Other Dysplasias of Bone).

- Kadler KE, Baldock C, Bella J, Boot-Handford RP: Collagens at a glance. *J Cell Sci* 2007;120:1955.
- Karsenty G, Kronenberg HM, Settembre C: Genetic control of bone formation. *Ann Rev Cell Develop Biol* 2009;25:629.
- Khosla S, Westendorf JJ, Oursler MJ: Building bone to reverse osteoporosis and repair fractures. *J Clin Invest* 2008;118:421.
- Muiznieks LD, Keeley FW: Molecular assembly and mechanical properties of the extracellular matrix: a fibrous protein perspective. *Biochim Biophys Acta* 2013;1832:866.
- Neufeld EF: From serendipity to therapy. *Annu Rev Biochem* 2011;80. (Describes pioneering work on the causes and treatment of mucopolysaccharidoses.)
- Rowe RG, Weiss SJ: Navigating ECM barriers at the invasive front: the cancer cell–stroma interface. *Annu Rev Cell Develop Biol* 2009;25:567.
- Scriver CR, Beaudet AL, Valle D, et al (editors): *The Metabolic and Molecular Bases of Inherited Disease*, 8th ed. McGraw-Hill, 2001. (This comprehensive four-volume text and the updated online version [see Chapter 1] contain chapters on disorders of collagen biosynthesis and structure, Marfan syndrome, the mucopolysaccharidoses, achondroplasia, Alport syndrome, and craniosynostosis syndromes.)
- Shoulders MD, Raines RT: Collagen structure and stability. *Ann Rev Biochem* 2009;78:929.

Muscle & the Cytoskeleton

Peter J. Kennelly, PhD and Robert K. Murray, MD, PhD

OBJECTIVES

After studying this chapter, you should be able to:

- Understand the general biochemical features of skeletal, cardiac, and smooth muscle contraction.
- Know the biologic effects of nitric oxide (NO).
- Explain the different metabolic fuel requirements for a sprint and for the marathon.
- Know the general structures and functions of the major components of the cytoskeleton, namely microfilaments, microtubules, and intermediate filaments.
- Understand the bases of malignant hyperthermia, Duchenne and Becker muscular dystrophies, inherited cardiomyopathies, the Hutchinson-Gilford syndrome (progeria), and several skin diseases due to abnormal keratins.

BIOMEDICAL IMPORTANCE

Proteins play an important role in **movement** at both the organ (eg, skeletal muscle, heart, and gut) and cellular levels. In this chapter, the roles of specific proteins and certain other key molecules (eg, Ca^{2+}) in **muscular contraction** are described. A brief coverage of **cytoskeletal proteins** is also presented.

Knowledge of the molecular bases of a number of conditions that affect muscle has advanced greatly in recent years. Understanding of the molecular basis of **Duchenne-type muscular dystrophy** was greatly enhanced when it was **discovered** that it was due to mutations in the gene encoding dystrophin. Significant progress has also been made in understanding the molecular basis of **malignant hyperthermia**, a serious complication for some patients undergoing certain types of anesthesia. **Heart failure** is a very common medical condition, with a variety of causes; its rational therapy requires understanding of the biochemistry of heart muscle. One group of conditions that cause heart failure is the **cardiomyopathies**, some of which are genetically determined. NO has been found to be a major regulator of smooth muscle tone. Many widely used **vasodilators**—such as nitroglycerin, used in the treatment of angina pectoris—act by increasing the formation of NO. Muscle, partly because of its mass, plays major roles in the **overall metabolism** of the body.

MUSCLE TRANSDUCES CHEMICAL ENERGY INTO MECHANICAL ENERGY

Muscle is the major biochemical **transducer** (machine) that converts potential (chemical) energy into kinetic (mechanical) energy. Muscle, the largest single tissue in the human body, makes up somewhat less than 25% of body mass at birth, more than 40% in the young adult, and somewhat less than 30% in the aged adult. We shall discuss aspects of the three types of muscles found in vertebrates: **skeletal**, **cardiac**, and **smooth**. Both skeletal and cardiac muscles appear **striated** upon microscopic observation; smooth muscle is **nonstriated**. Although skeletal muscle is under voluntary nervous control, the control of both cardiac and smooth muscle is involuntary.

Sarcoplasm of Muscle Cells Contains ATP, Phosphocreatine, & Glycolytic Enzymes

Striated muscle is composed of multinucleated muscle fiber cells surrounded by an electrically excitable plasma membrane, the **sarcolemma**. An individual muscle fiber cell, which may extend the entire length of the muscle, contains a bundle of many **myofibrils** arranged in parallel, embedded in intracellular fluid termed **sarcoplasm**. Within this fluid is contained

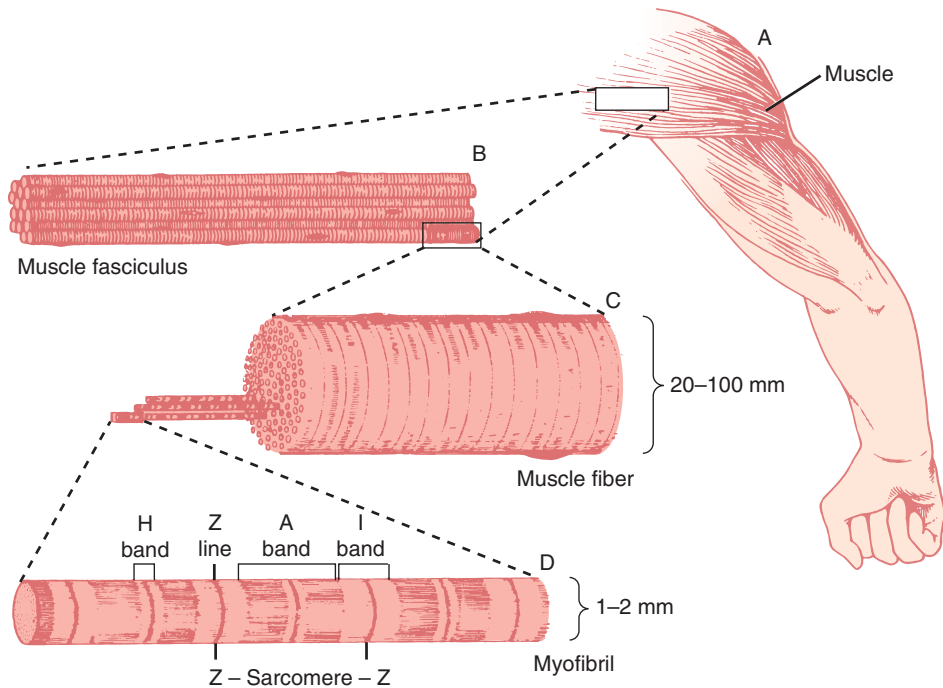

FIGURE 51-1 The structure of voluntary muscle. The sarcomere is the region between the Z lines. (Drawing by Sylvia Colard Keene. Reproduced, with permission, from Bloom W, Fawcett DW: *A Textbook of Histology*, 10th ed. Saunders, 1975.)

glycogen, the high-energy compounds ATP and phosphocreatine, and the enzymes of glycolysis.

Sarcomere Is the Functional Unit of Muscle

An overall view of voluntary muscle at several levels of organization is presented in **Figure 51-1**.

When the **myofibril** is examined by electron microscopy, alternating dark and light bands (anisotropic bands, meaning birefringent in polarized light, and isotropic bands, meaning not altered by polarized light) can be observed. These bands are thus referred to as **A and I bands**, respectively. The central region of the A band (the H band) appears less dense than the rest of the band. The I band is bisected by a very dense and narrow **Z line** (**Figure 51-2**).

The **sarcomere** is defined as the region between two Z lines (**Figures 51-1 and 51-2**) and is repeated along the axis of a fibril at distances of 1500 to 2300 nm depending upon the state of contraction.

The **striated** appearance of voluntary and cardiac muscle in light microscopic studies results from their high degree of organization, in which most muscle fiber cells are aligned so that their sarcomeres are in parallel register (**Figure 51-1**).

Thick Filaments Contain Myosin; Thin Filaments Contain Actin, Tropomyosin, & Troponin

When **myofibrils** are examined by electron microscopy, it appears that each one is constructed of two types of longitudinal filaments.

One type, the **thick filament**, confined to the A band, contains chiefly the protein myosin. These filaments are about 16 nm in diameter and arranged in the cross section as a hexagonal array (**Figure 51-2**, center; right-hand cross section).

The **thin filament** (about 7 nm in diameter) lies in the I band and extends into the A band but not into its H zone (**Figure 51-2**). Thin filaments contain the proteins actin, tropomyosin, and troponin (**Figure 51-3**). In the A band, the thin filaments are arranged around the thick (myosin) filament as a secondary hexagonal array. Each thin filament lies symmetrically between three thick filaments (**Figure 51-2**, center, mid cross section), and each thick filament is surrounded symmetrically by six thin filaments.

The thick and thin filaments interact via **cross bridges** that emerge at intervals of 14 nm along the thick filaments. As depicted in **Figure 51-2**, the cross bridges (drawn as arrowheads at each end of the myosin filaments, but not shown extending fully across to the thin filaments) have opposite polarities at the two ends of the thick filaments. The two poles of the thick filaments are separated by a 150-nm segment (the M band, not labeled in the figure) that is free of projections.

The Sliding Filament Cross-Bridge Model Is the Foundation on Which Current Thinking About Muscle Contraction Is Built

This model was proposed independently in the 1950s by Henry Huxley and Andrew Huxley and their colleagues. It was largely based on careful morphologic observations on resting,

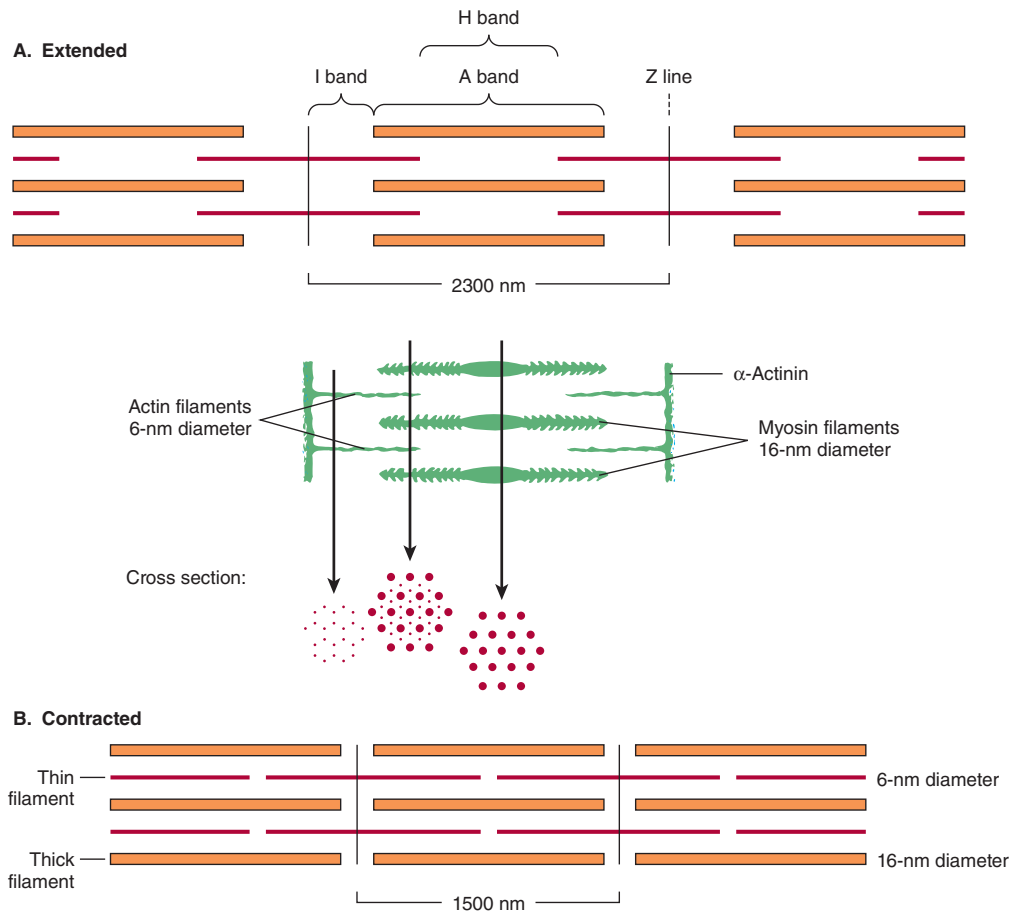

FIGURE 51-2 Arrangement of filaments in striated muscle. (A) Extended. The positions of the I, A, and H bands in the extended state are shown. The thin filaments partly overlap the ends of the thick filaments, and the thin filaments are shown anchored in the Z lines (often called Z disks). In the lower part of Figure 51-2A, “arrowheads,” pointing in opposite directions, are shown emanating from the myosin (thick) filaments. Four actin (thin) filaments are shown attached to two Z lines via α -actinin. The central region of the three myosin filaments, free of arrowheads, is called the M band (not labeled). Cross sections through the M bands, through an area where myosin and actin filaments overlap and through an area in which solely actin filaments are present, are shown. (B) Contracted. The actin filaments are seen to have slipped along the sides of the myosin fibers toward each other. The lengths of the thick filaments (indicated by the A bands) and the thin filaments (distance between Z lines and the adjacent edges of the H bands) have not changed. However, the lengths of the sarcomeres have been reduced (from 2300 to 1500 nm), and the lengths of the H and I bands are also reduced because of the overlap between the thick and thin filaments. These morphologic observations provided part of the basis for the sliding filament model of muscle contraction.

extended, and contracting muscle. Basically, when muscle contracts, there is no change in the lengths of the thick and thin filaments, but the H zones and the I bands shorten (see legend to Figure 51-2). Thus, the arrays of interdigitating filaments must **slide past one another** during contraction. **Cross-bridges** that link thick and thin filaments at certain stages in the contraction cycle generate and sustain the tension. The tension developed during muscle contraction is proportionate to the filament overlap and to the number of cross bridges. Each cross-bridge head is connected to the thick filament via a flexible fibrous segment that can bend outward from the thick filament. This flexible segment facilitates contact between the

head and the thin filament when necessary, yet is sufficiently pliant to be accommodated in the interfilament space.

ACTIN & MYOSIN ARE THE MAJOR PROTEINS OF MUSCLE

The mass of a muscle is made up of 75% water and more than 20% protein. The two major proteins are actin and myosin.

Monomeric **G-actin** (43 kDa; G, globular) makes up 25% of muscle protein by weight. At physiologic ionic strength and in the presence of Mg^{2+} , G-actin polymerizes noncovalently to form an insoluble double helical filament called F-actin

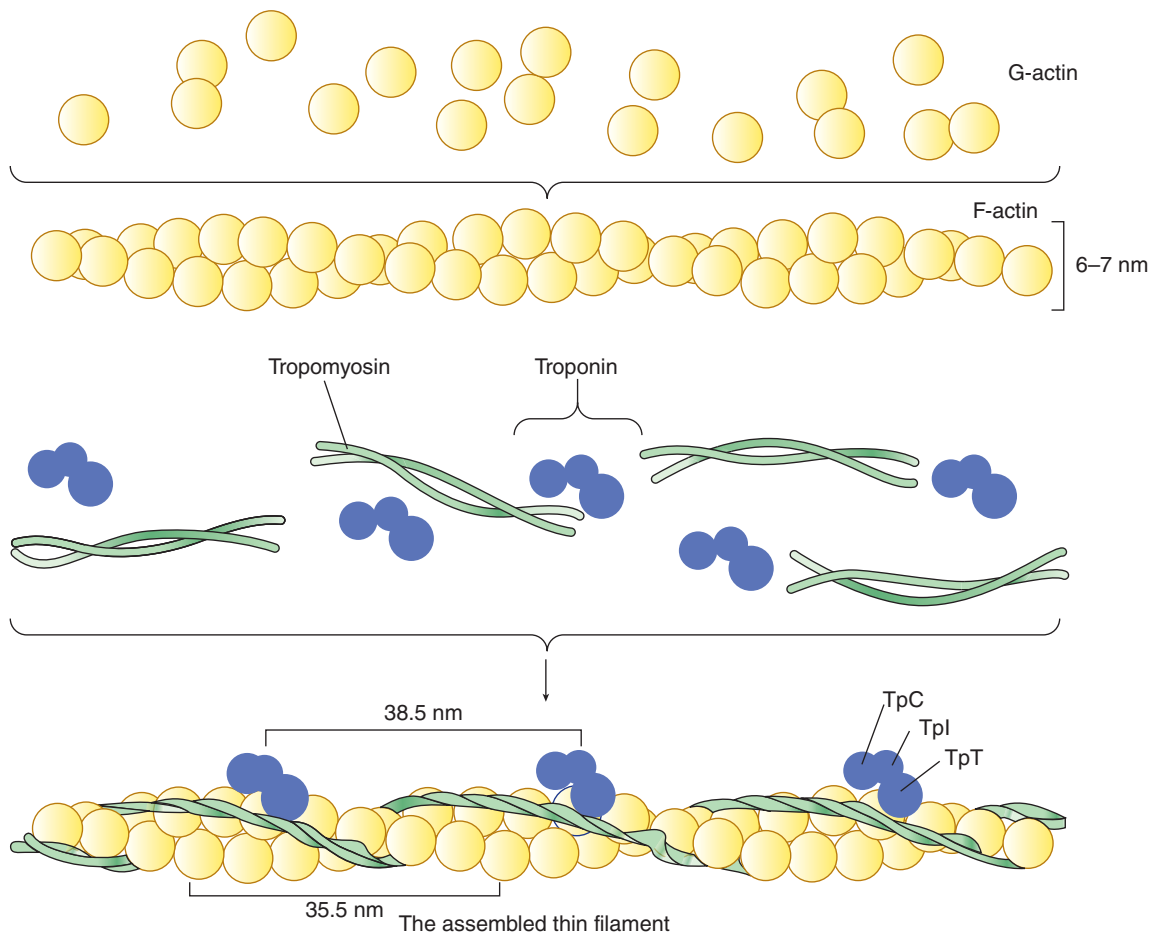

FIGURE 51-3 Schematic representation of the thin filament, showing the spatial configuration of its three major protein components: actin, troponin, and tropomyosin. The upper panel shows individual molecules of G-actin. The middle panel shows actin monomers assembled into F-actin. Individual molecules of tropomyosin (two strands wound around one another) and of troponin (made up of its three subunits) are also shown. The lower panel shows the assembled thin filament, consisting of F-actin, tropomyosin, and the three subunits of troponin (TpC, Tpl, and TpT).

(Figure 51-3). The **F-actin** fiber is 6 to 7 nm thick and has a pitch or repeating structure every 35.5 nm.

Myosins constitute a family of proteins, with at least 12 classes having been identified in the human genome. The myosin discussed in this chapter is **myosin-II**, and when myosin is referred to in this text, it is this species that is meant unless otherwise indicated. Myosin-I is a monomeric species that binds to cell membranes. It may serve as a linkage between microfilaments and the cell membrane in certain locations.

Myosin contributes 55% of muscle protein by weight and forms the **thick filaments**. It is an asymmetric hexamer with a molecular mass of approximately 460 kDa. Myosin has a fibrous tail consisting of two intertwined helices. Each helix has a globular head portion attached at one end (Figure 51-4). The hexamer consists of one pair of **heavy (H) chains** each of approximately 200 kDa molecular mass, and two pairs of **light (L) chains** each with a molecular mass of approximately 20 kDa. The L chains differ, one being called the **essential** light chain and the other the **regulatory** light chain. Skeletal muscle myosin binds actin to form **actomyosin** (actin-myosin), and its intrinsic ATPase activity is markedly enhanced in this complex.

Isoforms of myosin exist whose amounts can vary in different anatomic, physiologic, and pathologic situations.

The structures of actin and of the head of myosin have been determined by x-ray crystallography; these studies have confirmed a number of earlier findings concerning their structures and have also given rise to much new information.

Limited Digestion of Myosin with Proteases Has Helped to Elucidate Its Structure & Function

When myosin is digested with **trypsin**, two myosin fragments (meromyosins) are generated. **Light meromyosin** (LMM) consists of aggregated, insoluble α -helical fibers from the tail of myosin (Figure 51-4). LMM exhibits no ATPase activity and does not bind to F-actin.

Heavy meromyosin (HMM; molecular mass about 340 kDa) is a soluble protein that has both a fibrous portion and a globular portion (Figure 51-4). It exhibits **ATPase** activity and binds to F-actin. Digestion of HMM with **papain** generates two subfragments, S-1 and S-2. The S-2 fragment is fibrous

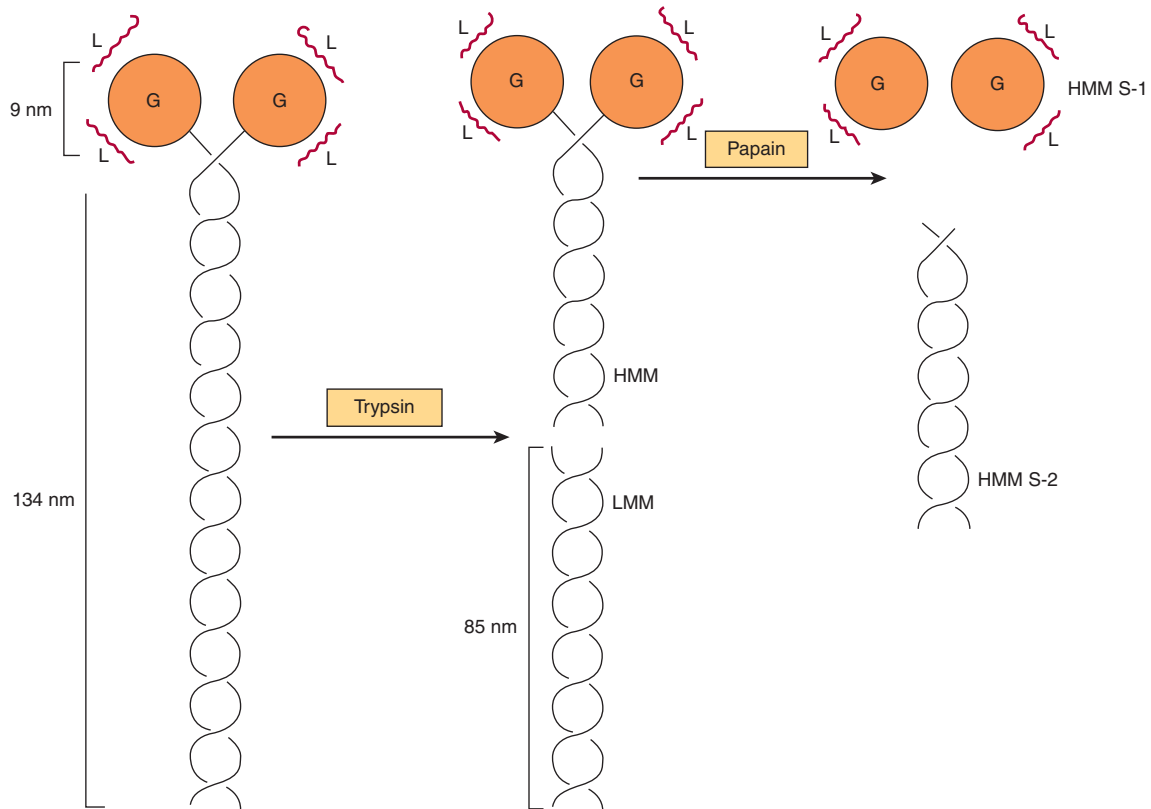

FIGURE 51-4 Diagram of a myosin molecule showing the two intertwined α -helices (fibrous portion), the globular region or head (G), the light chains (L), and the effects of proteolytic cleavage by trypsin and papain. The globular region (myosin head) contains an actin-binding site and an L chain-binding site and also attaches to the remainder of the myosin molecule.

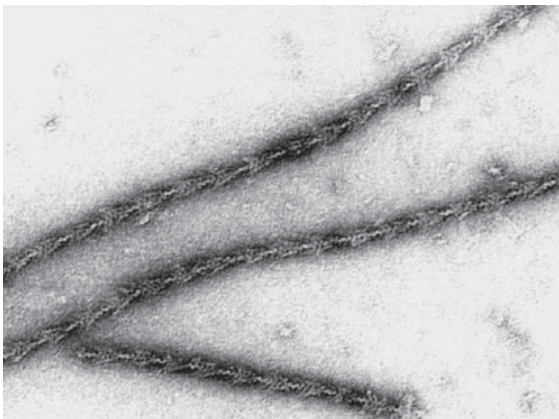

FIGURE 51-5 The decoration of actin filaments with the S-1 fragments of myosin to form "arrowheads." (Courtesy of JA Spudich.)

in character, has no ATPase activity, and does not bind to F-actin.

S-1 (molecular mass approximately 115 kDa) does exhibit ATPase activity, binds L chains, and, in the absence of ATP, will bind to and decorate actin with "arrowheads" (Figure 51-5). Both S-1 and HMM exhibit ATPase activity, which is accelerated 100- to 200-fold by complexing with F-actin. As discussed below, F-actin greatly enhances the rate at which myosin

ATPase releases its products, ADP and P_i . Thus, although F-actin does not affect the hydrolysis step per se, its ability to **promote release** of the products produced by the ATPase activity greatly accelerates the overall rate of catalysis.

CHANGES IN THE CONFORMATION OF THE HEAD OF MYOSIN DRIVE MUSCLE CONTRACTION

How can hydrolysis of ATP produce macroscopic movement? Muscle contraction essentially consists of the cyclic **attachment and detachment** of the S-1 head of myosin to the F-actin filaments. This process can also be referred to as the making and breaking of cross-bridges. The attachment of actin to myosin is followed by **conformational changes** that are of particular importance in the S-1 head and are dependent upon which nucleotide is present (ADP or ATP). These changes result in the **power stroke**, which drives movement of actin filaments past myosin filaments. The energy for the power stroke is ultimately supplied by ATP, which is hydrolyzed to ADP and P_i . However, the power stroke itself occurs as a result of **conformational changes** in the myosin head that occur when ADP dissociates.

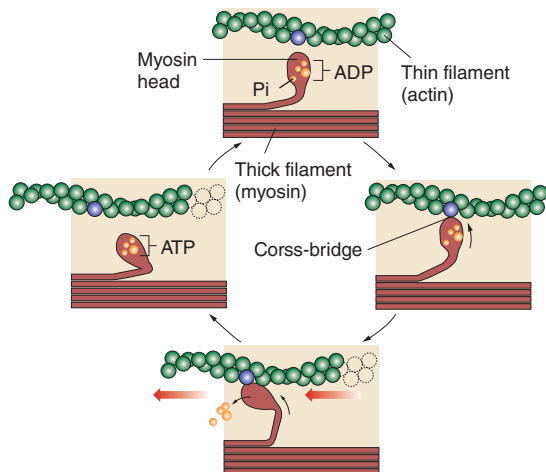

FIGURE 51-6 The hydrolysis of ATP drives the cyclic association and dissociation of actin and myosin in five reactions described in the text. (Reproduced with permission from McGraw-Hill Higher Education.)

The major biochemical events occurring during one cycle of muscle contraction and relaxation can be represented in the five steps shown in **Figure 51-6** as follows:

1. In the **relaxation phase** of muscle contraction, the S-1 head of myosin hydrolyzes ATP to ADP and P_i , but these products remain bound. The resultant ADP- P_i -myosin complex has been energized and is in a so-called high-energy conformation.
2. When **contraction** of muscle is stimulated (via events involving Ca^{2+} , troponin, tropomyosin, and actin, which are described below), actin becomes accessible and the S-1 head of myosin finds it, binds it, and forms the actin-myosin-ADP- P_i complex indicated.
3. Formation of this complex **promotes the release of P_i** , which initiates the power stroke. This is followed by release of ADP and is accompanied by a large conformational change in the head of myosin in relation to its tail (**Figure 51-7**), pulling actin about 10 nm toward the center of the sarcomere. This is the **power stroke**. The myosin is now in a so-called low-energy state, indicated as actin-myosin.
4. Another molecule of ATP binds to the S-1 head, forming an actin-myosin-ATP complex.
5. Myosin-ATP has a low affinity for actin, and **actin is thus released**. This last step is a key component of relaxation and is dependent upon the binding of ATP to the actin-myosin complex.

Another cycle then commences with the hydrolysis of ATP (step 1 of **Figure 51-6**), re-forming the high-energy conformation.

Thus, hydrolysis of ATP is used to drive the cycle, with the actual power stroke being the conformational change in the S-1 head that occurs upon the release of ADP. The **hinge regions** of myosin (referred to as flexible points at each end of S-2 in the legend to **Figure 51-7**) permit the large range of movement of S-1 and also allow S-1 to find actin filaments.

If intracellular **levels of ATP drop** (eg, after death), ATP is not available to bind the S-1 head (step 4 above), **actin does**

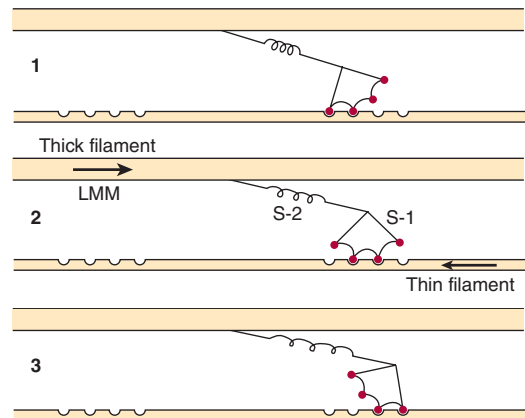

FIGURE 51-7 Representation of the active cross bridges between thick and thin filaments. This diagram was adapted by AF Huxley from HE Huxley: the mechanism of muscular contraction. *Science* 1969;164:1356. The latter proposed that the force involved in muscular contraction originates in a tendency for the myosin head (S-1) to rotate relative to the thin filament and is transmitted to the thick filament by the S-2 portion of the myosin molecule acting as an inextensible link. Flexible points at each end of S-2 permit S-1 to rotate and allow for variations in the separation between filaments. This figure is based on HE Huxley's proposal, but also incorporates elastic (the coils in the S-2 portion) and stepwise-shortening elements (depicted here as four sites of interaction between the S-1 portion and the thin filament). (See Huxley AF, Simmons RM: Proposed mechanism of force generation in striated muscle. *Nature [Lond]* 1971;233:533.) The strengths of binding of the attached sites are higher in position 2 than in position 1 and higher in position 3 than position 2. The myosin head can be detached from position 3 with the utilization of a molecule of ATP; this is the predominant process during shortening. The myosin head is seen to vary in its position from about 90° to about 45° , as indicated in the text. (S-1, myosin head; S-2, portion of the myosin molecule; LMM) (see legend to **Figure 49-4**). (Reproduced from Huxley AF: Muscular contraction. *J Physiol* 1974;243:1. By kind permission of the author and the *Journal of Physiology*.)

not dissociate, and relaxation (step 5) does not occur. This is the explanation for **rigor mortis**, the stiffening of the body that occurs after death.

Calculations have indicated that the **efficiency** of contraction is about 50%; that of the internal combustion engine is less than 20%.

Tropomyosin & the Troponin Complex Present in Thin Filaments Perform Key Functions in Striated Muscle

In striated muscle, there are two other proteins that are minor in terms of their mass but important in terms of their function. **Tropomyosin** is a fibrous molecule that consists of two chains, alpha and beta, that attach to F-actin in the groove between its filaments (**Figure 51-3**). Tropomyosin is present in all muscular and muscle-like structures. The **troponin complex** is unique to striated muscle and consists of three polypeptides. **Troponin T** (TpT) binds to tropomyosin as well as to the other two troponin components. **Troponin I** (TpI) inhibits the F-actin-myosin interaction and also binds to the

other components of troponin. **Troponin C (TpC)** is a calcium-binding polypeptide that is structurally and functionally analogous to **calmodulin**, an important calcium-binding protein widely distributed in nature. Up to four calcium ions can bind per molecule of troponin C or calmodulin, both of which have a molecular mass of 17 kDa.

Ca²⁺ Plays a Central Role in Regulation of Muscle Contraction

The contraction of muscles from all sources occurs by the general mechanism described above. While muscles from different organisms and from different cells and tissues within the same organism may have different molecular mechanisms responsible for regulating their contraction and relaxation, in all systems, **Ca²⁺** plays a key role. There are two general mechanisms of **regulation** of muscle contraction: **actin-based** and **myosin-based**. The former operates in skeletal and cardiac muscles, the latter in smooth muscle.

Actin-Based Regulation Occurs in Striated Muscle

Actin-based regulation of muscle occurs in vertebrate skeletal and cardiac muscles, both striated. In the general mechanism described above (Figure 51–6), the only potentially limiting factor in the cycle of muscle contraction might be ATP. The skeletal muscle system is **inhibited** at rest; this inhibition is relieved to activate contraction. The inhibitor of striated muscle is the **troponin system**, which is bound to tropomyosin and F-actin in the thin filament (Figure 51–3). In striated muscle, there is no control of contraction unless the tropomyosin-troponin systems are present along with the actin and myosin filaments. As described above, **tropomyosin** lies along the groove of F-actin, and the three components of **troponin**—TpT, TpI, and TpC—are bound to the F-actin-tropomyosin complex. TpI prevents binding of the myosin head to its F-actin attachment site either by altering the conformation of F-actin via the tropomyosin molecules or by simply rolling tropomyosin into a position that directly blocks the sites on F-actin to which the myosin heads attach. Either way prevents activation of the myosin ATPase that is mediated by binding of the myosin head to F-actin. Hence, the TpI system blocks the contraction cycle at step 2 of Figure 51–6. This accounts for the **inhibited state** of relaxed striated muscle.

The Sarcoplasmic Reticulum Regulates Intracellular Levels of Ca²⁺ in Skeletal Muscle

In the sarcoplasm of resting muscle, the concentration of Ca²⁺ is 10⁻⁸ to 10⁻⁷ mol/L. The resting state is achieved because Ca²⁺ is pumped into the sarcoplasmic reticulum (SR) through the action of an active transport system, called the Ca²⁺ ATPase (Figure 51–8), initiating relaxation. The SR is a network of fine membranous sacs. Inside the SR, Ca²⁺ is bound to a specific Ca²⁺-binding protein—designated **calsequestrin**. The sarcomere is surrounded by an excitable membrane

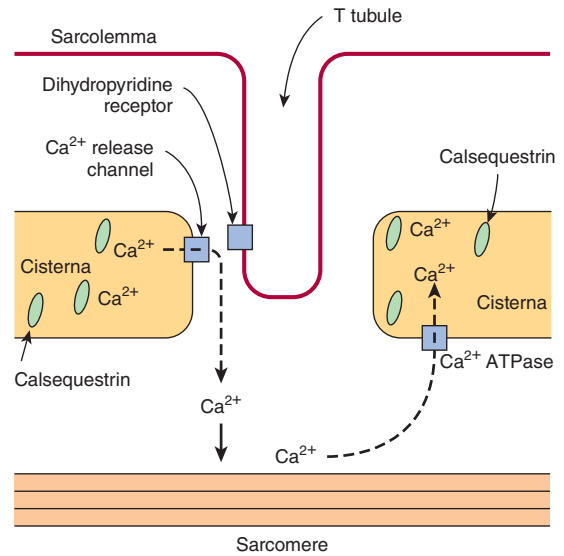

FIGURE 51–8 Diagram of the relationships among the sarcolemma (plasma membrane), a T tubule, and two cisternae of the SR of skeletal muscle (not to scale). The T tubule extends inward from the sarcolemma. A wave of depolarization, initiated by a nerve impulse, is transmitted from the sarcolemma down the T tubule. It is then conveyed to the Ca²⁺ release channel (RYR), perhaps by interaction between it and the dihydropyridine receptor (slow Ca²⁺ voltage channel), which are shown in close proximity. Release of Ca²⁺ from the Ca²⁺ release channel into the cytosol initiates contraction. Subsequently, Ca²⁺ is pumped back into the cisternae of the SR by the Ca²⁺ ATPase (Ca²⁺ pump) and stored there, in part bound to calsequestrin.

(the T-tubule system) composed of transverse (T) channels closely associated with the SR.

When the sarcolemma is excited by a **nerve impulse**, the signal is transmitted into the T-tubule system and a **Ca²⁺ release channel** in the nearby SR opens, releasing Ca²⁺ from the SR into the sarcoplasm. The concentration of Ca²⁺ in the sarcoplasm rises rapidly to 10⁻⁵ mol/L. The Ca²⁺-binding sites on TpC in the thin filament are quickly occupied by Ca²⁺. The TpC-4Ca²⁺ interacts with TpI and TpT to alter their interaction with tropomyosin. Accordingly, tropomyosin moves out of the way or alters the conformation of F-actin so that the myosin head-ADP-P_i (Figure 51–6) can interact with F-actin to start the contraction cycle.

The Ca²⁺ release channel is also known as the **ryanodine receptor** (RYR). There are two isoforms of this receptor, RYR1 and RYR2, the former being present in skeletal muscle and the latter in heart muscle and brain. **Ryanodine** is a plant alkaloid that binds to RYR1 and RYR2 specifically and modulates their activities. The Ca²⁺ release channel is a homotetramer made up of four subunits of 565 kDa. It has transmembrane sequences at its carboxyl terminal, and these probably form the Ca²⁺ channel. The remainder of the protein protrudes into the cytosol, bridging the gap between the SR and the transverse tubular membrane. The channel is ligand-gated, Ca²⁺ and ATP working synergistically *in vitro*, although how it operates *in vivo* is not clear. A possible sequence of events leading to opening of the channel is shown in Figure 51–9. The channel

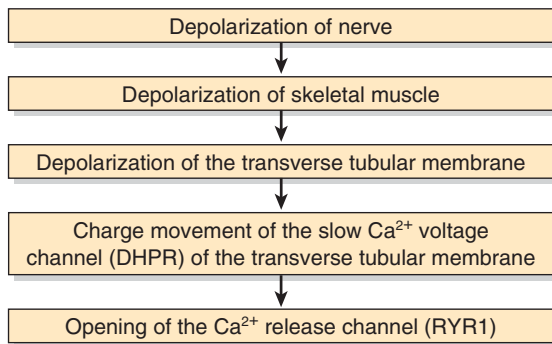

FIGURE 51-9 Possible chain of events leading to opening of the Ca^{2+} release channel. As indicated in the text, the Ca^{2+} voltage channel and the Ca^{2+} release channel have been shown to interact with each other in vitro via specific regions in their polypeptide chains. (DHPR, dihydropyridine receptor; RYR1, RYR 1.)

lies very close to the **dihydropyridine receptor (DHPR)**, a voltage-dependent calcium channel of the transverse tubule system (Figure 51-8). Experiments in vitro employing an affinity column chromatography approach have indicated that a 37-amino-acid stretch in RYR1 interacts with one specific loop of DHPR.

Relaxation occurs when sarcoplasmic Ca^{2+} falls below 10^{-7} mol/L owing to its resequestration into the SR by Ca^{2+} ATPase. TpC-4 Ca^{2+} thus loses its Ca^{2+} . Consequently, **troponin**, via interaction with tropomyosin, **inhibits** further interaction between the myosin head and F-actin, and in the presence of ATP the myosin head detaches from the F-actin.

Thus, Ca^{2+} controls skeletal muscle contraction and relaxation by an allosteric mechanism mediated by TpC, TpI, TpT, tropomyosin, and F-actin.

A **decrease** in the concentration of ATP in the sarcoplasm (eg, by excessive usage during the cycle of contraction-relaxation or by diminished formation, such as might occur in ischemia) has two major effects: (1) The Ca^{2+} ATPase (Ca^{2+} pump) in the SR ceases to maintain the low concentration of Ca^{2+} in the sarcoplasm. Thus, the interaction of the myosin heads with F-actin is promoted. (2) The ATP-dependent **detachment of myosin heads** from F-actin cannot occur, and rigidity (contracture) sets in. The condition of **rigor mortis**, following death, is an extension of these events.

Muscle contraction is a delicate dynamic balance of the attachment and detachment of myosin heads to F-actin, subject to fine regulation via the nervous system.

Table 51-1 summarizes the overall events in contraction and relaxation of skeletal muscle.

Mutations in the Gene Encoding the Ca^{2+} Release Channel Are One Cause of Human Malignant Hyperthermia

Some genetically predisposed patients experience a severe reaction, designated **malignant hyperthermia (MH)**, on exposure to certain anesthetics (eg, halothane) and depolarizing skeletal

TABLE 51-1 Sequence of Events in Contraction and Relaxation of Skeletal Muscle

Steps in Contraction
1. Discharge of motor neuron.
2. Release of transmitter (acetylcholine) at motor endplate.
3. Binding of acetylcholine to nicotinic acetylcholine receptors.
4. Increased Na^+ and K^+ conductance in endplate membrane.
5. Generation of endplate potential.
6. Generation of action potential in muscle fibers.
7. Inward spread of depolarization along T tubules.
8. Release of Ca^{2+} from terminal cisterns of sarcoplasmic reticulum and diffusion to thick and thin filaments.
9. Binding of Ca^{2+} to troponin C, uncovering myosin binding sites of actin.
10. Formation of cross-linkages between actin and myosin and sliding of thin on thick filaments, producing shortening.
Steps in Relaxation
1. Ca^{2+} pumped back into sarcoplasmic reticulum.
2. Release of Ca^{2+} from troponin.
3. Cessation of interaction between actin and myosin.

Source: Reproduced, with permission, from Barrett KE, Barman SM, Boitano S, et al: *Ganong's Review of Medical Physiology*, 24th ed. McGraw-Hill, 2012.

muscle relaxants (eg, succinylcholine). The reaction consists primarily of rigidity of skeletal muscles, hypermetabolism, and high fever. A **high cytosolic concentration of Ca^{2+}** in skeletal muscle is a major factor in its causation. Unless malignant hyperthermia is recognized and treated immediately, patients may die acutely of ventricular fibrillation or survive to succumb subsequently from other serious complications. Appropriate treatment is to stop the anesthetic and administer the drug **dantrolene** intravenously. Dantrolene is a skeletal muscle relaxant that acts to inhibit release of Ca^{2+} from the SR into the cytosol, thus preventing the increase of cytosolic Ca^{2+} found in MH.

MH also occurs in **swine**. Susceptible animals homozygous for MH respond to stress with a fatal reaction (**porcine stress syndrome**) similar to that exhibited by humans. If the reaction occurs prior to slaughter, it affects the quality of the pork adversely, resulting in an inferior product. Both events can result in considerable economic losses for the swine industry.

The finding of a high level of cytosolic Ca^{2+} in muscle in MH suggested that the condition might be caused by abnormalities of the Ca^{2+} ATPase or of the **Ca^{2+} release channel**. No abnormalities were detected in the former, but sequencing of cDNAs for the latter protein proved insightful, particularly in swine. All cDNAs from **swine** with MH so far examined have shown a substitution of T for C1843, resulting in the substitution of Cys for Arg⁶¹⁵ in the Ca^{2+} release channel. The mutation affects the function of the channel in that it opens more easily and remains open longer; the net result is massive release of Ca^{2+} into the cytosol, ultimately causing sustained muscle contraction.

The picture is more complex in **humans**, since MH exhibits **genetic heterogeneity**. Members of a number of families who suffer from malignant hyperthermia have not shown genetic linkage to the RYR1 gene. Some humans susceptible to MH

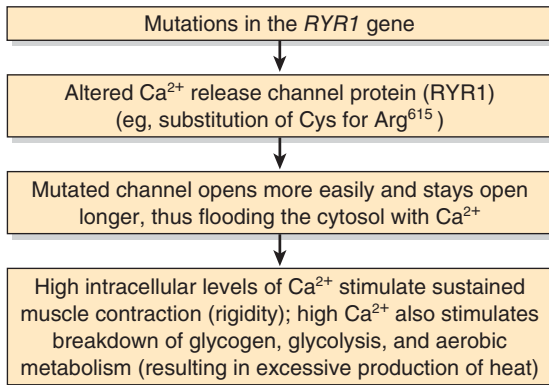

FIGURE 51–10 Simplified scheme of the causation of malignant hyperthermia (OMIM 145600). Many different point mutations have been detected in the *RYR1* gene, some of which are associated with central core disease (OMIM 117000). It is estimated that at least 50% of families with members who have malignant hyperthermia are linked to the *RYR1* gene. Some individuals with mutations in the gene encoding DHPR have also been detected; it is possible that mutations in other genes for proteins involved in certain aspects of muscle metabolism will also be found.

have been found to exhibit the same mutation found in swine, while others have a variety of point mutations at different loci in the *RYR1* gene. Certain families with MH have been found to have mutations affecting the **DHPR**. It is possible that mutations affecting other muscle proteins, such as **calsequestrin-1**, a SR Ca^{2+} -binding protein that modulates RyR1 function may also cause MH. **Figure 51–10** summarizes the probable chain of events in malignant hyperthermia. The major promise of these findings is that, once additional mutations are detected, it will be possible to **screen**, using suitable DNA probes, for individuals at risk of developing MH during anesthesia. Current screening tests (eg, the in vitro caffeine-halothane test) are relatively unreliable. Affected individuals could then be given **alternative anesthetics**, which would not endanger their lives. It should also be possible, if desired, to eliminate MH from swine populations using suitable breeding practices.

Another condition due to mutations in the *RYR1* gene is **central core disease**. This is a rare myopathy presenting in infancy with hypotonia and proximal muscle weakness. Electron microscopy reveals an absence of mitochondria in the center of many type I (see below) muscle fibers. Damage to mitochondria induced by high intracellular levels of Ca^{2+} secondary to abnormal functioning of *RYR1* appears to be responsible for the morphologic findings.

MUTATIONS IN THE GENE ENCODING DYSTROPHIN CAUSE DUCHENNE MUSCULAR DYSTROPHY

A number of **additional proteins** play various roles in the structure and function of muscle. They include titin (the largest protein known), nebulin, α -actinin, desmin, dystrophin,

TABLE 51–2 Some Other Important Proteins of Muscle

Protein	Location	Comment or Function
Titin	Reaches from the Z line to the M line	Largest protein in body. Role in relaxation of muscle.
Nebulin	From Z line along length of actin filaments	May regulate assembly and length of actin filaments.
α -Actinin	Anchors actin to Z lines	Stabilizes actin filaments.
Desmin	Lies alongside actin filaments	Attaches to plasma membrane (plasmalemma).
Dystrophin	Attached to plasmalemma	Deficient in Duchenne muscular dystrophy. Mutations of its gene can also cause dilated cardiomyopathy.
Calcineurin	Cytosol	A calmodulin-regulated protein phosphatase. May play important roles in cardiac hypertrophy and in regulating amounts of slow and fast twitch muscles.
Myosin-binding protein C	Arranged transversely in sarcomere A-bands	Binds myosin and titin. Plays a role in maintaining the structural integrity of the sarcomere.

and calcineurin. Some properties of these proteins are summarized in **Table 51–2**.

Dystrophin is of special interest. Mutations in the gene encoding this protein have been shown to be the cause of **Duchenne muscular dystrophy** and the milder **Becker muscular dystrophy**. They are also implicated in some cases of **dilated cardiomyopathy** (see below). As shown in **Figure 51–11**, dystrophin forms a part of a large complex of proteins that attach to or interact with the plasmalemma. Dystrophin links the actin cytoskeleton to the ECM and appears to be needed for assembly of the synaptic junction. Impairment of these processes by formation of defective dystrophin is thought to be critical in the causation of Duchenne muscular dystrophy. Mutations in the genes encoding some of the components of the **sarcoglycan complex** shown in **Figure 51–11** are responsible for **limb-girdle** and certain **other congenital forms** of muscular dystrophy.

Mutations in genes encoding **several glycosyltransferases** involved in the synthesis of the sugar chains of **α -dystroglycan** have been found to be the cause of certain types of **congenital muscular dystrophy** (see Chapter 46).

CARDIAC MUSCLE RESEMBLES SKELETAL MUSCLE IN MANY RESPECTS

The general picture of muscle contraction in the heart resembles that of skeletal muscle. Cardiac muscle, like skeletal muscle, is **striated** and uses the actin-myosin-tropomyosin-troponin system described above. Unlike skeletal muscle, cardiac muscle

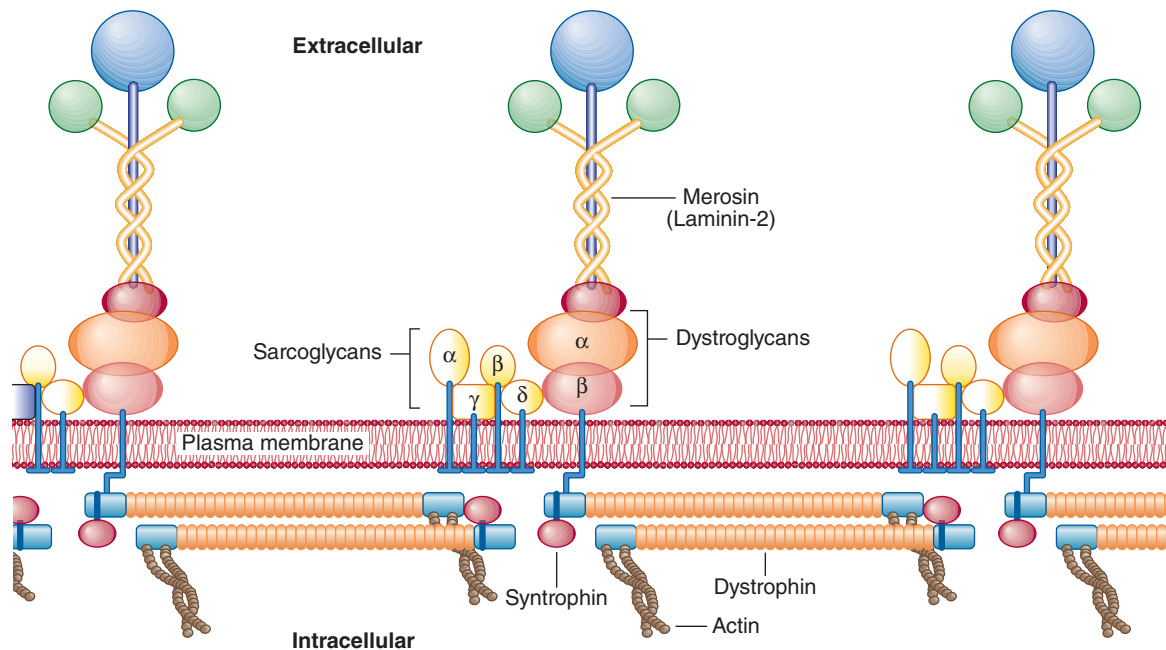

FIGURE 51-11 Organization of dystrophin and other proteins in relation to the plasma membrane of muscle cells. Dystrophin is part of a large oligomeric complex associated with several other protein complexes. The dystroglycan complex consists of α -dystroglycan, which associates with the basal lamina protein merosin (also named laminin-2, see Chapter 50), and α -dystroglycan, which binds α -dystroglycan and dystrophin. Syntrophin binds to the carboxyl terminal of dystrophin. The sarcoglycan complex consists of four transmembrane proteins: α -, β -, γ -, and δ -sarcoglycan. The function of the sarcoglycan complex and the nature of the interactions within the complex and between it and the other complexes are not clear. The sarcoglycan complex is formed only in striated muscle, and its subunits preferentially associate with each other, suggesting that the complex may function as a single unit. Mutations in the gene encoding dystrophin cause Duchenne and Becker muscular dystrophy. Mutations in the genes encoding the various sarcoglycans have been shown to be responsible for limb-girdle dystrophies (eg, OMIM 604286) and mutations in genes encoding other muscle proteins cause other types of muscular dystrophy. Mutations in genes encoding certain glycosyltransferases involved in the synthesis of the glycan chains of α -dystroglycan are responsible for certain congenital muscular dystrophies. (Reproduced, with permission, from Duggan DJ et al: Mutations in the sarcoglycan genes in patients with myopathy. *N Engl J Med* 1997;336:618. Copyright © 1997 Massachusetts Medical Society. All rights reserved.)

exhibits **intrinsic rhythmicity**, and individual myocytes communicate with each other because of its syncytial nature. The **T-tubular system** is more developed in cardiac muscle, whereas the **SR** is less extensive and consequently the intracellular supply of Ca^{2+} for contraction is less. Cardiac muscle thus relies on **extracellular Ca^{2+}** for contraction; if isolated cardiac muscle is deprived of Ca^{2+} , it ceases to beat within approximately 1 minute, whereas skeletal muscle can continue to contract without an extracellular source of Ca^{2+} for a longer period. **Cyclic AMP** plays a more prominent role in cardiac than in skeletal muscle. It modulates intracellular levels of Ca^{2+} through the activation of the protein kinases that phosphorylate various transport proteins in the sarcolemma and SR. They also target the troponin-tropomyosin regulatory complex, affecting its responsiveness to intracellular Ca^{2+} . There is a rough correlation between the phosphorylation of TpI and the increased contraction of cardiac muscle induced by catecholamines. This may account for the **inotropic effects** (increased contractility) of β -adrenergic compounds on the heart. Some differences among skeletal, cardiac, and smooth muscle are summarized in **Table 51-3**.

Ca^{2+} Enters Myocytes via Ca^{2+} Channels & Leaves via the $\text{Na}^{+}\text{-Ca}^{2+}$ Exchanger & the Ca^{2+} ATPase

As stated, **extracellular Ca^{2+}** plays an important role in contraction of cardiac muscle but not in skeletal muscle. This means that Ca^{2+} both enters and leaves myocytes in a regulated manner. We shall briefly consider three transmembrane proteins that play roles in this process.

Ca^{2+} Channels

Ca^{2+} enters myocytes via highly selective channels. The major portal of entry is the L-type (long-duration current, large conductance) or **slow Ca^{2+}** channel, which is voltage-gated, opening during depolarization induced by spread of the cardiac action potential and closing when the action potential declines. These channels are equivalent to the dihydropyridine receptors of skeletal muscle (Figure 51-8). Slow Ca^{2+} channels are **regulated** by cAMP-dependent protein kinases (stimulatory) and cGMP-dependent protein kinases (inhibitory) They are inhibited by so-called calcium channel blockers (eg, verapamil). **Fast** (or T, transient) Ca^{2+} channels are also present in the

TABLE 51-3 Some Differences among Skeletal, Cardiac, and Smooth Muscle

Skeletal Muscle	Cardiac Muscle	Smooth Muscle
1. Striated	1. Striated	1. Nonstriated
2. No syncytium	2. Syncytial	2. Syncytial
3. Small T tubules	3. Large T tubules	3. Generally rudimentary T tubules
4. Sarcoplasmic reticulum well developed and Ca ²⁺ pump acts rapidly.	4. Sarcoplasmic reticulum present and Ca ²⁺ pump acts relatively rapidly.	4. Sarcoplasmic reticulum often rudimentary and Ca ²⁺ pump acts slowly.
5. Plasmalemma contains few hormone receptors.	5. Plasmalemma contains a variety of receptors (eg, α - and β -adrenergic).	5. Plasmalemma contains a variety of receptors (eg, α - and β -adrenergic).
6. Nerve impulse initiates contraction.	6. Has intrinsic rhythmicity.	6. Contraction initiated by nerve impulses, hormones, etc.
7. Extracellular fluid Ca ²⁺ not important for contraction.	7. Extracellular fluid Ca ²⁺ important for contraction.	7. Extracellular fluid Ca ²⁺ important for contraction.
8. Troponin system present.	8. Troponin system present.	8. Lacks troponin system; uses regulatory head of myosin.
9. Caldesmon not involved.	9. Caldesmon not involved.	9. Caldesmon is important regulatory protein.
10. Very rapid cycling of the cross-bridges.	10. Relatively rapid cycling of the cross-bridges.	10. Slow cycling of the cross-bridges permits slow, prolonged contraction and less utilization of ATP.

plasmalemma, though in much lower numbers; they probably contribute to the early phase of increase of myoplasmic Ca²⁺.

The resultant increase of Ca²⁺ in the myoplasm acts on the Ca²⁺ release channel of the SR to open it. This is called **Ca²⁺-induced Ca²⁺ release (CICR)**. It is estimated that approximately 10% of the Ca²⁺ involved in contraction enters the cytosol from the extracellular fluid and 90% from the SR. However, the former 10% is important, as the rate of increase of Ca²⁺ in the myoplasm is important, and entry via the Ca²⁺ channels contributes appreciably to this.

Ca²⁺-Na⁺ Exchanger

This is the principal route of **exit** of Ca²⁺ from myocytes. In resting myocytes, it helps to maintain a low level of free intracellular Ca²⁺ by exchanging one Ca²⁺ for three Na⁺. The energy for the uphill movement of Ca²⁺ out of the cell comes from the downhill movement of Na⁺ into the cell from the plasma. This exchange contributes to relaxation, but may run in the reverse direction during excitation. Because of the Ca²⁺-Na⁺ exchanger, anything that causes intracellular Na⁺ (Na_i⁺) to rise will secondarily cause Ca_i²⁺ to rise, causing more forceful contraction. This is referred to as a **positive inotropic effect**. One example is when the drug **digitalis** is used to treat heart failure. Digitalis inhibits the sarcolemmal Na⁺-K⁺-ATPase, diminishing the exit of Na⁺ by this route, thus increasing Na_i⁺. This promotes the inflow of Ca²⁺ via the Ca²⁺-Na⁺ exchanger. The increased Ca_i²⁺ results in increased force of cardiac contraction (**Figure 51-12**), of benefit in heart failure.

Ca²⁺ ATPase

While this Ca²⁺ pump, situated in the sarcolemma, also contributes to Ca²⁺ exit, it is believed to play a relatively minor role as compared with the Ca²⁺-Na⁺ exchanger.

It should be noted that a variety of **ion channels** (see Chapter 40) are present in most cells, for Na⁺, K⁺, Ca²⁺, etc. Many of them have been cloned and their dispositions in their respective membranes worked out (number of times each one

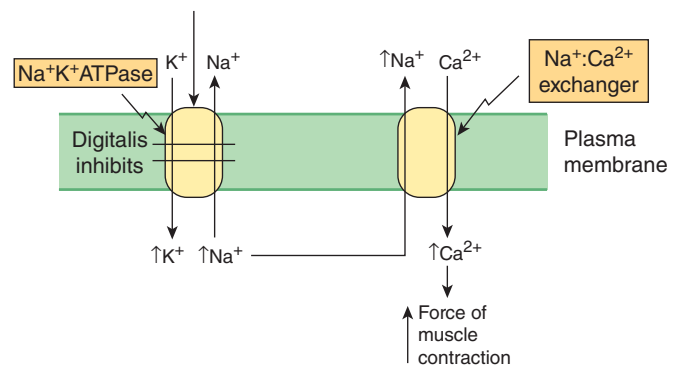

FIGURE 51-12 Scheme of how the drug digitalis (used in the treatment of certain cases of heart failure) increases cardiac contraction. Digitalis inhibits the Na⁺-K⁺ ATPase (see Chapter 40). This results in less Na⁺ being pumped out of the cardiac myocyte and leads to an increase of the intracellular concentration of Na⁺. In turn, this stimulates the Na⁺-Ca²⁺ exchanger so that more Na⁺ is exchanged outward, and more Ca²⁺ enters the myocyte. The resulting increased intracellular concentration of Ca²⁺ increases the force of muscular contraction.

crosses its membrane, location of the actual ion transport site in the protein, etc). They can be classified as indicated in **Table 51-4**. Cardiac muscle is rich in ion channels, and they are also important in skeletal muscle. Mutations in genes encoding ion channels have been shown to be responsible for a number of relatively rare conditions affecting muscle. These and other diseases due to mutations of ion channels have been termed **channelopathies**; some are listed in **Table 51-5**.

Inherited Cardiomyopathies Are due to Disorders of Cardiac Energy Metabolism or to Abnormal Myocardial Proteins

An **inherited cardiomyopathy** is any structural or functional abnormality of the ventricular myocardium due to an inherited cause. There are nonheritable types of cardiomyopathy, but these will not be described here. As shown in **Table 51-6**,

TABLE 51-4 Major Types of Ion Channels Found in Cells

Type	Comment
External ligand gated	Open in response to a specific extracellular molecule, for example, acetylcholine.
Internal ligand gated	Open or close in response to a specific intracellular molecule, for example, a cyclic nucleotide.
Voltage gated	Open in response to a change in membrane potential, for example, Na ⁺ , K ⁺ , and Ca ²⁺ channels in heart.
Mechanically gated	Open in response to change in mechanical pressure.

TABLE 51-5 Some Disorders (Channelopathies) due to Mutations in Genes Encoding Polypeptide Constituents of Ion Channels

Disorder ^a	Ion Channel and Major Organs Involved
Central core disease (OMIM 117000)	Ca ²⁺ release channel (RYR1), skeletal muscle
Hyperkalemic periodic paralysis (OMIM 170500)	Sodium channel, skeletal muscle
Hypokalemic periodic paralysis (OMIM 170400)	Slow Ca ²⁺ voltage channel (DHPR), skeletal muscle
Malignant hyperthermia (OMIM 145600)	Ca ²⁺ release channel (RYR1), skeletal muscle
Myotonia congenita (OMIM 160800)	Chloride channel, skeletal muscle

^aOther channelopathies include the long QT syndrome (OMIM 192500); pseudoaldosteronism (Liddle syndrome, OMIM 177200); persistent hyperinsulinemic hypoglycemia of infancy (OMIM 601820); hereditary X-linked recessive type II nephrolithiasis of infancy (Dent syndrome, OMIM 300009); and generalized myotonia, recessive (Becker disease, OMIM 255700). The term “myotonia” signifies any condition in which muscles do not relax after contraction.

Source: Data in part from Ackerman NJ, Clapham DE: Ion channels—basic science and clinical disease. *N Engl J Med* 1997;336:1575.

TABLE 51-6 Biochemical Causes of Inherited Cardiomyopathies^a

Cause	Proteins or Process Affected
Inborn errors of fatty acid oxidation	Carnitine entry into cells and mitochondria Certain enzymes of fatty acid oxidation
Disorders of mitochondrial oxidative phosphorylation	Proteins encoded by mitochondrial genes Proteins encoded by nuclear genes
Abnormalities of myocardial contractile and structural proteins	β-Myosin heavy chains, troponin, tropomyosin, dystrophin

^aMutations (eg, point mutations, or in some cases deletions) in the genes (nuclear or mitochondrial) encoding various proteins, enzymes, or tRNA molecules are the fundamental causes of the inherited cardiomyopathies. Some conditions are mild, whereas others are severe and may be part of a syndrome affecting other tissues

Source: Based on Kelly DP, Strauss AW: Inherited cardiomyopathies. *N Engl J Med* 1994;330:913.

the causes of inherited cardiomyopathies fall into two broad classes: (1) disorders of **cardiac energy metabolism**, mainly reflecting mutations in genes encoding enzymes or proteins involved in fatty acid oxidation (a major source of energy for the myocardium) and oxidative phosphorylation; (2) mutations in genes encoding proteins involved in or **affecting myocardial contraction**, such as myosin, tropomyosin, the troponins, and cardiac myosin-binding protein C. Mutations in the genes encoding these latter proteins cause familial hypertrophic cardiomyopathy, which will now be discussed.

Mutations in the Cardiac β-Myosin Heavy Chain Gene Are One Cause of Familial Hypertrophic Cardiomyopathy

Familial hypertrophic cardiomyopathy is one of the most frequent hereditary cardiac diseases. Patients exhibit hypertrophy—often massive—of one or both ventricles, starting early in life, unrelated to any extrinsic cause such as hypertension. Most cases are transmitted in an autosomal dominant manner; the rest are sporadic. Until recently, its cause was obscure. However, this situation changed when studies of one affected family showed that a **missense mutation** (ie, substitution of one amino acid by another) in the **β-myosin heavy chain gene** was responsible for the condition. Subsequent studies have shown a number of missense mutations in this gene, all coding for highly conserved residues. Some individuals have shown other mutations, such as formation of an α/β-myosin heavy chain hybrid gene. Patients with familial hypertrophic cardiomyopathy can show great variation in clinical picture. This in part reflects **genetic heterogeneity**; that is, mutation in a number of **other genes** (eg, those encoding cardiac actin, tropomyosin, cardiac troponins I and T, essential and regulatory myosin light chains, cardiac myosin-binding protein C, titin, and mitochondrial tRNA-glycine and tRNA-isoleucine) may also cause familial hypertrophic cardiomyopathy. In addition, mutations at different sites in the gene for β-myosin heavy chain may affect the function of the protein to a greater or lesser extent. The missense mutations are clustered in the head and head-rod regions of the myosin heavy chain. One hypothesis is that the mutant polypeptides (“poison polypeptides”) cause formation of abnormal myofibrils, eventually resulting in compensatory hypertrophy. Some mutations alter the **charge** of an amino acid side chain (eg, substitution of arginine for glutamine) which presumably affects the **conformation** of the protein more markedly than other substitutions. Patients with these mutations have a significantly shorter life expectancy than patients in whom the mutation produced no alteration in charge. Thus, definition of the precise mutations involved in the genesis of FHC may prove to be of important prognostic value; it can be accomplished by appropriate use of the polymerase chain reaction on genomic DNA obtained from one sample of blood lymphocytes. **Figure 51-13** is a simplified scheme of the events causing familial hypertrophic cardiomyopathy.

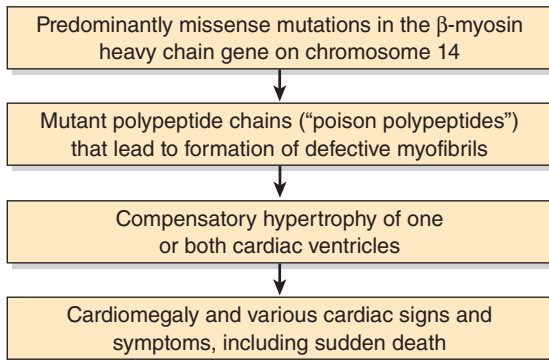

FIGURE 51-13 Simplified scheme of the causation of familial hypertrophic cardiomyopathy (OMIM 192600) due to mutations in the gene encoding β -myosin heavy chain. Mutations in genes encoding other proteins (see text) can also cause this condition.

Another type of cardiomyopathy is termed **dilated cardiomyopathy**. Mutations in the genes encoding dystrophin, muscle LIM protein (so-called because it was found to contain a cysteine-rich domain originally detected in three proteins: Lin-II, Isl-1, and Mec-3), the cyclic response-element binding protein (CREB), desmin, and lamin have been implicated in the causation of this condition. The first two proteins help organize the contractile apparatus of cardiac muscle cells, and CREB is involved in the regulation of a number of genes in these cells. Current research is not only elucidating the molecular causes of the cardiomyopathies but is also disclosing mutations that cause **cardiac developmental disorders** (eg, septal defects) and **arrhythmias** (eg, due to mutations affecting ion channels).

Ca^{2+} Also Regulates Contraction of Smooth Muscle

While all muscles contain actin, myosin, and tropomyosin, only vertebrate **striated** muscles contain the **troponin system**. Thus, the mechanisms that regulate contraction must differ in various contractile systems.

Smooth muscles have molecular structures similar to those in striated muscle, but the sarcomeres are not aligned so as to generate the striated appearance. Smooth muscles contain α -actinin and tropomyosin molecules, as do skeletal muscles. They **do not have the troponin system**, and the light chains of smooth muscle myosin molecules differ from those of striated muscle myosin. Regulation of smooth muscle contraction is **myosin-based**, unlike striated muscle, which is actin-based. However, like striated muscle, smooth muscle contraction is **regulated by Ca^{2+}** .

Phosphorylation of Myosin Light Chains Initiates Contraction of Smooth Muscle

When smooth muscle myosin is bound to F-actin in the absence of other muscle proteins such as tropomyosin, there is **no detectable ATPase activity**. This absence of activity is quite unlike the situation described for striated muscle myosin and F-actin, which has abundant ATPase activity. Smooth muscle myosin contains **light chains** that prevent the binding of the

myosin head to F-actin; they **must be phosphorylated** before they allow F-actin to activate myosin ATPase. The ATPase activity then attained hydrolyzes ATP about 10-fold more slowly than the corresponding activity in skeletal muscle. The phosphate on the myosin light chains may form a chelate with the Ca^{2+} bound to the tropomyosin-TpC-actin complex, leading to an increased rate of formation of cross bridges between the myosin heads and actin. The phosphorylation of light chains **initiates** the attachment-detachment contraction cycle of smooth muscle.

Myosin Light Chain Kinase Is Activated by Calmodulin- 4Ca^{2+} & Then Phosphorylates the Light Chains

Smooth muscle sarcoplasm contains a **myosin light chain kinase** that is calcium dependent. The Ca^{2+} activation of myosin light chain kinase requires binding of **calmodulin- 4Ca^{2+}** to its kinase subunit (**Figure 51-14**). The calmodulin- 4Ca^{2+} -activated light chain kinase phosphorylates the light chains, which then cease to inhibit the myosin-F-actin interaction. The contraction cycle then begins.

Another non- Ca^{2+} -dependent pathway exists in smooth muscle for initiating contraction. This involves **Rho kinase**, which is activated by a variety of stimuli (not shown in Figure 51-14). This enzyme phosphorylates myosin light chain phosphatase, inhibiting it, and thus increasing the level of phosphorylated light chains. Rho kinase also directly phosphorylates the light chain of myosin. Both of these actions increase the contraction of smooth muscle.

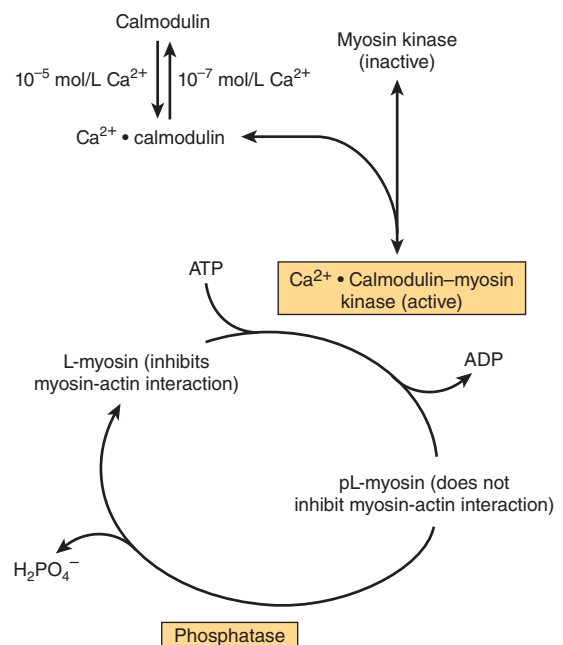

FIGURE 51-14 Regulation of smooth muscle contraction by Ca^{2+} . The pL-myosin is the phosphorylated light chain of myosin and L-myosin is the dephosphorylated light chain. (Adapted, with permission, from Adelstein RS, Eisenberg R: Regulation and kinetics of actin-myosin ATP interaction. *Annu Rev Biochem* 1980;49:921. Copyright © 1980 by Annual Reviews, www.annualreviews.org.)

Smooth Muscle Relaxes When the Concentration of Ca^{2+} Falls Below 10^{-7} Molar

Relaxation of smooth muscle occurs when sarcoplasmic Ca^{2+} falls below 10^{-7} mol/L. Ca^{2+} then dissociates from calmodulin, which in turn dissociates from the myosin light chain kinase, which renders the kinase inactive. No new phosphates are attached to the p-light chain, and **light chain protein phosphatase**, which is continually active and calcium independent, removes the existing phosphates from the light chains. Dephosphorylated myosin p-light chain then inhibits the binding of myosin heads to F-actin and their ATPase activity. The myosin head detaches from the F-actin in the presence of ATP, but it cannot reattach because of the presence of dephosphorylated p-light chain; hence, **relaxation** occurs.

Table 51–7 summarizes and compares the regulation of actin-myosin interactions (activation of myosin ATPase) in striated and smooth muscles.

TABLE 51–7 Actin-Myosin Interactions in Striated and Smooth Muscle

	Striated Muscle	Smooth Muscle (and Nonmuscle Cells)
Proteins of muscle filaments	Actin Myosin Tropomyosin Troponin (T _{pl} , T _{pT} , T _{pC})	Actin Myosin ^a Tropomyosin
Spontaneous interaction of F-actin and myosin alone (spontaneous activation of myosin ATPase by F-actin)	Yes	No
Inhibitor of F-actin–myosin interaction (inhibitor of F-actin-dependent activation of ATPase)	Troponin system (T _{pl})	Unphosphorylated myosin light chain
Contraction activated by	Ca^{2+}	Ca^{2+}
Direct effect of Ca^{2+}	4Ca^{2+} bind to T _{pC}	4Ca^{2+} bind to calmodulin
Effect of protein-bound Ca^{2+}	T _{pC} - 4Ca^{2+} antagonizes T _{pl} inhibition of F-actin–myosin interaction (allows F-actin activation of ATPase)	Calmodulin- 4Ca^{2+} activates myosin light chain kinase that phosphorylates myosin p-light chain. The phosphorylated p-light chain no longer inhibits F-actin–myosin interaction (allows F-actin activation of ATPase)

^aLight chains of myosin are different in striated and smooth muscles.

The myosin light chain kinase is not directly affected or activated by **cAMP**. However, cAMP-activated protein kinase can phosphorylate myosin light chain kinase (not the chains themselves). Phosphorylated myosin light chain kinase exhibits a significantly lower affinity for calmodulin- 4Ca^{2+} and thus is less sensitive to activation. Accordingly, an **increase in cAMP dampens the contraction response** of smooth muscle to a given elevation of sarcoplasmic Ca^{2+} . This molecular mechanism can explain the relaxing effect of β -adrenergic stimulation on smooth muscle.

Another protein that appears to play a Ca^{2+} -dependent role in the regulation of smooth muscle contraction is **caldesmon** (87 kDa). This protein is ubiquitous in smooth muscle and is also found in nonmuscle tissue. At low concentrations of Ca^{2+} , it binds to tropomyosin and actin. This **prevents interaction of actin with myosin**, keeping muscle in a relaxed state. At higher concentrations of Ca^{2+} , calmodulin- 4Ca^{2+} binds caldesmon, **releasing it from actin**. The latter is then free to bind to myosin, and contraction can occur. Caldesmon is also subject to phosphorylation-dephosphorylation; when phosphorylated, it cannot bind actin, again freeing the latter to interact with myosin. Caldesmon may also participate in organizing the structure of the contractile apparatus in smooth muscle. Many of its effects have been demonstrated in vitro, and its physiologic significance is still under investigation.

As noted in Table 51–3, slow cycling of the cross-bridges permits slow prolonged contraction of smooth muscle (eg, in viscera and blood vessels) with less utilization of ATP compared with striated muscle. The ability of smooth muscle to maintain force at reduced velocities of contraction is referred to as the **latch state**; this is an important feature of smooth muscle, and its precise molecular bases are under study.

Nitric Oxide (NO) Relaxes the Smooth Muscle of Blood Vessels & Also Has Many Other Important Biologic Functions

Acetylcholine is a vasodilator that acts by causing relaxation of the smooth muscle of blood vessels. However, it does not act directly on smooth muscle. A key observation was that if **endothelial cells** were stripped away from underlying smooth muscle cells, acetylcholine no longer exerted its vasodilator effect. This finding indicated that vasodilators such as acetylcholine initially interact with the endothelial cells of small blood vessels via receptors. The receptors are coupled to the phosphoinositide cycle, leading to the intracellular release of Ca^{2+} through the action of inositol trisphosphate. In turn, the elevation of Ca^{2+} leads to the liberation of **endothelium-derived relaxing factor (EDRF)**, which diffuses into the adjacent smooth muscle. There, it reacts with the heme moiety of a soluble guanylyl cyclase, resulting in activation of the latter, with a consequent elevation of intracellular levels of **cGMP** (**Figure 51–15**). This in turn stimulates the activities of certain cGMP-dependent protein kinases, which probably phosphorylate specific muscle proteins, causing relaxation; however, the details are still being clarified. The important coronary artery

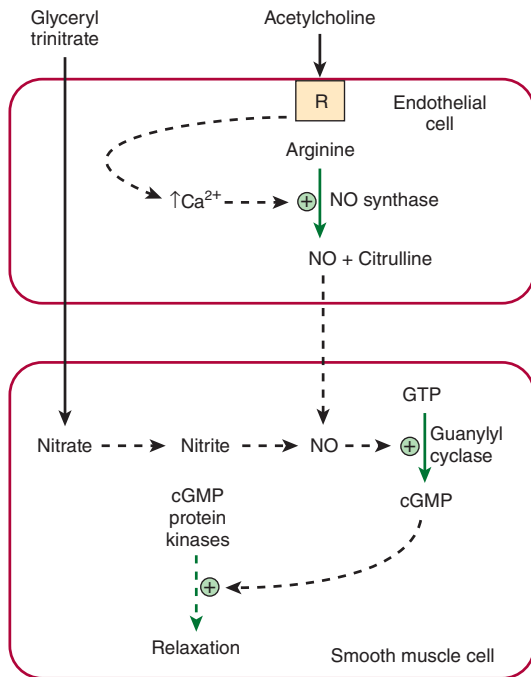

FIGURE 51–15 Diagram showing formation in an endothelial cell of nitric oxide (NO) from arginine in a reaction catalyzed by NO synthase. Interaction of an agonist (eg, acetylcholine) with a receptor (R) probably leads to intracellular release of Ca^{2+} via inositol trisphosphate generated by the phosphoinositide pathway, resulting in activation of NO synthase. The NO subsequently diffuses into adjacent smooth muscle, where it leads to activation of guanylyl cyclase, formation of cGMP, stimulation of cGMP protein kinases, and subsequent relaxation. The vasodilator nitroglycerin is shown entering the smooth muscle cell, where its metabolism also leads to formation of NO.

vasodilator **nitroglycerin**, widely used to relieve angina pectoris, acts to increase intracellular release of EDRF and thus of cGMP.

Quite unexpectedly, EDRF was found to be the gas **NO**. NO is formed by the action of the enzyme NO synthase, which is cytosolic. The endothelial and neuronal forms of NO synthase are activated by Ca^{2+} (Table 51–8). The substrate is **arginine**, and the products are citrulline and NO.

NO synthase catalyzes a five-electron oxidation of an amine nitrogen of arginine. L-hydroxyarginine is an intermediate that remains tightly bound to the enzyme. NO synthase is a very complex enzyme, employing five redox cofactors: NADPH, FAD, FMN, heme, and tetrahydrobiopterin. NO can also be formed from **nitrite**, derived from vasodilators such as glyceryl trinitrate during their metabolism. NO has a very short half-life (approximately 3–4 seconds) in tissues because it reacts with oxygen and superoxide. The product of the reaction with superoxide is **peroxynitrite** (ONOO^-), which yields the highly reactive $\text{OH} \cdot$ radical when it decomposes. NO binds tightly to hemoglobin and other heme proteins. **Chemical inhibitors of NO synthase** are available that can markedly decrease formation of NO. Administration of such inhibitors leads to vasoconstriction and a marked elevation of blood pressure, indicating that NO is of major importance in the maintenance of blood pressure in vivo. Another important cardiovascular effect is the **inhibition of platelet aggregation**, a consequence of the increased synthesis of cGMP (see Chapter 51).

Since the discovery of the role of NO as a vasodilator, there has been intense experimental interest in this molecule. It has turned out to have a variety of physiologic roles, involving virtually every tissue of the body (Table 51–9). Three major isoforms of NO synthase have been identified, each of which has been cloned, and the chromosomal locations of their genes in humans have been determined. Gene knockout experiments have been performed on each of the three isoforms and have helped establish some of the postulated functions of NO.

To summarize, research in the past decade has shown that NO plays an important role in many physiologic and pathologic processes.

SEVERAL MECHANISMS REPLENISH STORES OF ATP IN MUSCLE

The **ATP** required as the constant energy source for the contraction–relaxation cycle of muscle can be generated (1) by glycolysis, using blood glucose or muscle glycogen, (2) by

TABLE 51–8 Summary of the Nomenclature of the NO Synthases and of the Effects of Knockout of Their Genes in Mice

Subtype	Name ^a	Comments	Result of Gene Knockout in Mice ^b
1	nNOS	Activity depends on elevated Ca^{2+} ; first identified in neurons; calmodulin-activated	Pyloric stenosis, resistant to vascular stroke, aggressive sexual behavior (males)
2	iNOS ^c	Independent of elevated Ca^{2+} ; prominent in macrophages	More susceptible to certain types of infection
3	eNOS	Activity depends on elevated Ca^{2+} ; first identified in endothelial cells	Elevated mean blood pressure

^ae, endothelial; i, inducible; n, neuronal. ^bGene knockouts were performed by homologous recombination in mice. The enzymes are characterized as neuronal, inducible (macrophage), and endothelial because these were the sites in which they were first identified. However, all three enzymes have been found in other sites, and the neuronal enzyme is also inducible. Each gene has been cloned, and its chromosomal location in humans has been determined. ^ciNOS is Ca^{2+} -independent but binds calmodulin very tightly.

Source: Adapted from Snyder SH: NO. *Nature* 1995;377:196.

TABLE 51–9 Some Physiologic Functions and Pathologic Involvements of Nitric Oxide (NO)

• Vasodilator, important in regulation of blood pressure.
• Involved in penile erection; sildenafil citrate (Viagra) affects this process by inhibiting a cGMP phosphodiesterase.
• Neurotransmitter in the brain and the peripheral autonomic nervous system.
• Role in long-term potentiation.
• Role in neurotoxicity.
• Low level of NO involved in causation of pylorospasm in infantile hypertrophic pyloric stenosis.
• May have role in relaxation of skeletal muscle.
• May constitute part of a primitive immune system.
• Inhibits adhesion, activation, and aggregation of platelets.

oxidative phosphorylation, (3) from creatine phosphate, and (4) from two molecules of ADP in a reaction catalyzed by adenylyl kinase (**Figure 51–16**). The amount of ATP in skeletal muscle is only sufficient to provide energy for contraction for a few seconds, so that ATP must be constantly renewed from one or more of the above sources, depending upon metabolic conditions. As discussed below, there are at least **two distinct types of fibers** in skeletal muscle, one predominantly active in **aerobic** conditions and the other in **anaerobic** conditions; not unexpectedly, they use each of the above sources of energy to different extents.

Skeletal Muscle Contains Large Quantities of Glycogen

The sarcoplasm of skeletal muscle contains large stores of **glycogen**, located in granules close to the I bands. The release of glucose from glycogen is dependent on a specific muscle **glycogen**

phosphorylase (see Chapter 18), which can be activated by Ca^{2+} , epinephrine, and AMP. To generate glucose 6-phosphate for glycolysis in skeletal muscle, glycogen phosphorylase b must be activated to phosphorylase a via phosphorylation by phosphorylase b kinase (see Chapter 18). Ca^{2+} promotes the activation of phosphorylase b kinase, also by phosphorylation. Thus, Ca^{2+} both initiates muscle contraction and activates a pathway providing the energy needed. The hormone **epinephrine** also activates glycogenolysis in muscle. **AMP**, produced by the activity of adenylyl kinase on ADP during muscular exercise, can also allosterically activate phosphorylase b. Muscle glycogen phosphorylase b is inactive in **McArdle disease**, one of the glycogen storage diseases (see Chapter 18).

Under Aerobic Conditions, Muscle Generates ATP Mainly by Oxidative Phosphorylation

Synthesis of ATP via **oxidative phosphorylation** requires a supply of oxygen. Muscles that have a high demand for oxygen as a result of sustained contraction (eg, to maintain posture) store it attached to the heme moiety of **myoglobin**. Because of the heme moiety, muscles containing myoglobin are red, whereas muscles with little or no myoglobin are white. **Glucose**, derived from the blood glucose or from endogenous glycogen, and **fatty acids**, derived from the triacylglycerols of adipose tissue, are the principal substrates used for aerobic metabolism in muscle.

Creatine Phosphate Constitutes a Major Energy Reserve in Muscle

Creatine phosphate prevents the rapid depletion of ATP by providing a readily available high-energy phosphate that can be used to regenerate ATP from ADP. Creatine phosphate is

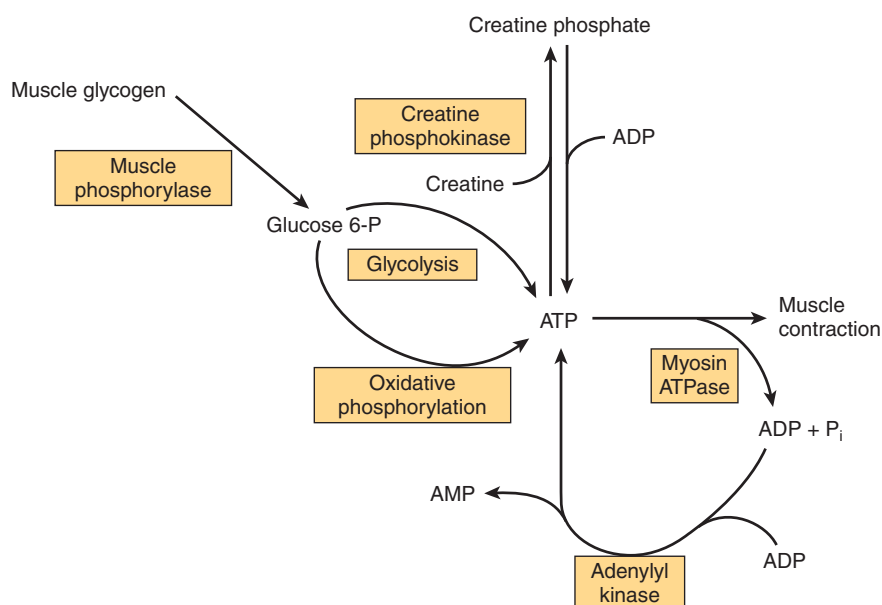
**FIGURE 51–16** The multiple sources of ATP in muscle.

formed from ATP and creatine (Figure 51–16) at times when the muscle is relaxed and the demand for ATP is relatively low. The enzyme catalyzing the phosphorylation of creatine is **creatine kinase** (CK), a muscle-specific enzyme with clinical utility in the detection of acute or chronic diseases of muscle.

SKELETAL MUSCLE CONTAINS SLOW (RED) & FAST (WHITE) TWITCH FIBERS

Different types of fibers have been detected in skeletal muscle. One classification subdivides them into type I (slow twitch), type IIA (fast twitch-oxidative), and type IIB (fast twitch-glycolytic). For the sake of simplicity, we shall consider only two types: type I (slow twitch, oxidative) and type II (fast twitch, glycolytic) (Table 51–10). The **type I** fibers are red because they contain myoglobin and mitochondria; their metabolism is aerobic, and they maintain relatively sustained contractions. The **type II** fibers, lacking myoglobin and containing few mitochondria, are white: they derive their energy from anaerobic glycolysis and exhibit relatively short durations of contraction. The **proportion** of these two types of fibers varies among the muscles of the body, depending on the function (eg, whether or not a muscle is involved in sustained contraction, such as maintaining posture). The proportion also varies with **training**; for example, the number of type I fibers in certain leg muscles increases in athletes training for marathons, whereas the number of type II fibers increases in sprinters.

A Sprinter Uses Creatine Phosphate & Anaerobic Glycolysis to Make ATP, Whereas a Marathon Runner Uses Oxidative Phosphorylation

In view of the two types of fibers in skeletal muscle and of the various energy sources described above, it is of interest to compare their involvement in a sprint (eg, 100 m) and in the marathon (42.2 km; just over 26 miles) (Table 51–11).

The major sources of energy in the **100-m sprint** are **creatine phosphate** (first 4–5 sec) and then **anaerobic glycolysis**,

TABLE 51–10 Characteristics of Type I and Type II Fibers of Skeletal Muscle

	Type I Slow Twitch	Type II Fast Twitch
Myosin ATPase	Low	High
Energy utilization	Low	High
Mitochondria	Many	Few
Color	Red	White
Myoglobin	Yes	No
Contraction rate	Slow	Fast
Duration	Prolonged	Short

TABLE 51–11 Types of Muscle Fibers and Major Fuel Sources Used by a Sprinter and by a Marathon Runner

Sprinter (100 m)	Marathon Runner
Type II (glycolytic) fibers are used predominantly	Type I (oxidative) fibers are used predominantly
Creatine phosphate is the major energy source during the first 4–5 s	Oxidative phosphorylation is the major energy source throughout
Glucose derived from muscle glycogen and metabolized by anaerobic glycolysis is the major fuel source	Blood glucose and free fatty acids are the major fuel sources
Muscle glycogen is rapidly depleted	Muscle glycogen is slowly depleted

using muscle glycogen as the source of glucose. The two main sites of metabolic control are at **glycogen phosphorylase** and at **PFK-1**. The former is activated by Ca^{2+} (released from the SR during contraction), epinephrine, and AMP. PFK-1 is activated by AMP, P_i , and NH_3 . Attesting to the efficiency of these processes, the flux through glycolysis can increase as much as 1000-fold during a sprint.

In contrast, in the **marathon**, **aerobic metabolism** is the principal source of ATP. The major fuel sources are **blood glucose** and **free fatty acids**, largely derived from the breakdown of triacylglycerols in adipose tissue, stimulated by epinephrine. Hepatic glycogen is degraded to maintain the level of blood glucose. Muscle glycogen is also a fuel source, but it is degraded much more gradually than in a sprint. It has been calculated that the amount of glucose in the blood, glycogen in the liver, glycogen in muscle, and triacylglycerol in adipose tissue is sufficient to supply muscle with energy during a marathon for 4, 18, 70, and approximately 4000 min, respectively. However, the rate of oxidation of fatty acids by muscle is slower than that of glucose, so that oxidation of glucose and of fatty acids is a major source of energy in the marathon.

A number of procedures have been used by athletes to counteract muscle fatigue and inadequate strength. These include **carbohydrate loading**, **soda (sodium bicarbonate) loading**, **blood doping** (administration of red blood cells), and ingestion of **creatine** and **androstenedione**.

SKELETAL MUSCLE CONSTITUTES THE MAJOR RESERVE OF PROTEIN IN THE BODY

In humans, **skeletal muscle protein** is the major nonfat source of stored energy. This explains very large losses of muscle mass, particularly in adults, resulting from prolonged caloric undernutrition.

The study of **tissue protein breakdown** in vivo is difficult, because amino acids released during intracellular breakdown of proteins can be extensively reutilized for protein synthesis within the cell. The amino acids also may be transported to other organs where they enter anabolic pathways. However, actin and myosin are methylated by a posttranslational

reaction that forms **3-methylhistidine**. During intracellular breakdown of actin and myosin, 3-methylhistidine is released and excreted into the urine. The urinary output of the methylated amino acid provides a reliable index of the rate of myofibrillar protein breakdown in the musculature of human subjects.

Various features of muscle metabolism, most of which are dealt with in other chapters of this text, are summarized in **Table 51–12**.

THE CYTOSKELETON PERFORMS MULTIPLE CELLULAR FUNCTIONS

Nonmuscle cells also perform mechanical work, including self-propulsion, morphogenesis, cleavage, endocytosis, exocytosis, intracellular transport, and changing cell shape. These cellular

TABLE 51–12 Summary of Major Features of the Biochemistry of Skeletal Muscle Related to Its Metabolism^a

• Skeletal muscle functions under both aerobic (resting) and anaerobic (eg, sprinting) conditions, so both aerobic and anaerobic glycolysis operate, depending on conditions.
• Skeletal muscle contains myoglobin as a reservoir of oxygen.
• Skeletal muscle contains different types of fibers primarily suited to anaerobic (fast twitch fibers) or aerobic (slow twitch fibers) conditions.
• Actin, myosin, tropomyosin, troponin complex (TpT, TpI, and TpC), ATP, and Ca ²⁺ are key constituents in relation to contraction.
• The Ca ²⁺ ATPase, the Ca ²⁺ release channel, and calsequestrin are proteins involved in various aspects of Ca ²⁺ metabolism in muscle.
• Insulin acts on skeletal muscle to increase uptake of glucose.
• In the fed state, most glucose is used to synthesize glycogen, which acts as a store of glucose for use in exercise; “preloading” with glucose is used by some long-distance athletes to build up stores of glycogen.
• Epinephrine stimulates glycogenolysis in skeletal muscle, whereas glucagon does not because of the absence of its receptors.
• Skeletal muscle cannot contribute directly to blood glucose because it does not contain glucose-6-phosphatase.
• Lactate produced by anaerobic metabolism in skeletal muscle passes to liver, which uses it to synthesize glucose, which can then return to muscle (the Cori cycle).
• Skeletal muscle contains phosphocreatine, which acts as an energy store for short-term (seconds) demands.
• Free fatty acids in plasma are a major source of energy, particularly under marathon conditions and in prolonged starvation.
• Skeletal muscle can utilize ketone bodies during starvation.
• Skeletal muscle is the principal site of metabolism of branched chain amino acids, which are used as an energy source.
• Proteolysis of muscle during starvation supplies amino acids for gluconeogenesis.
• Major amino acids emanating from muscle are alanine (destined mainly for gluconeogenesis in liver and forming part of the glucose-alanine cycle) and glutamine (destined mainly for the gut and kidneys).

^aThis table brings together material from various chapters in this book.

TABLE 51–13 Some Properties of Microfilaments and Microtubules

	Microfilaments	Microtubules
Protein(s)	Actin	α- and β-tubulins
Diameter	8–9 nm	25 nm
Functions	Structural, motility	Structural, motility, polarity

Note: Some properties of intermediate filaments are described in Table 51–14.

functions are carried out by an extensive intracellular network of filamentous structures constituting the **cytoskeleton**. The cell cytoplasm is not a sac of fluid, as once thought. Essentially all eukaryotic cells contain three types of filamentous structures: **actin filaments** (also known as microfilaments), **microtubules**, and **intermediate filaments**. Each type of filament can be distinguished biochemically and by the electron microscope. Some properties of these three structures are summarized in **Tables 51–13** and **51–14**.

Nonmuscle Cells Contain Actin That Forms Microfilaments

G-actin is present in most if not all cells of the body. With appropriate concentrations of magnesium and potassium chloride, it spontaneously polymerizes to form double helical **F-actin** filaments like those seen in muscle. There are at least

TABLE 51–14 Classes of Intermediate Filaments of Eukaryotic Cells and Their Distributions

Proteins	Molecular Mass (kDa)	Distributions
Lamins		
A, B, and C	65-75	Nuclear lamina
Keratins		
Type I (acidic)	40-60	Epithelial cells, hair, nails
Type II (basic)	50-70	As for type I (acidic)
Vimentin-like		
Vimentin	54	Various mesenchymal cells
Desmin	53	Muscle
Glial fibrillary acid protein	50	Glial cells
Peripherin	66	Neurons
Neurofilaments		
Low (L), medium (M), and high (H) ^a	60-130	Neurons

^aRefers to their molecular masses.

Note: Intermediate filaments have an approximate diameter of 10 nm and have various functions. For example, keratins are distributed widely in epithelial cells and adhere via adapter proteins to desmosomes and hemidesmosomes. Lamins provide support for the nuclear membrane.

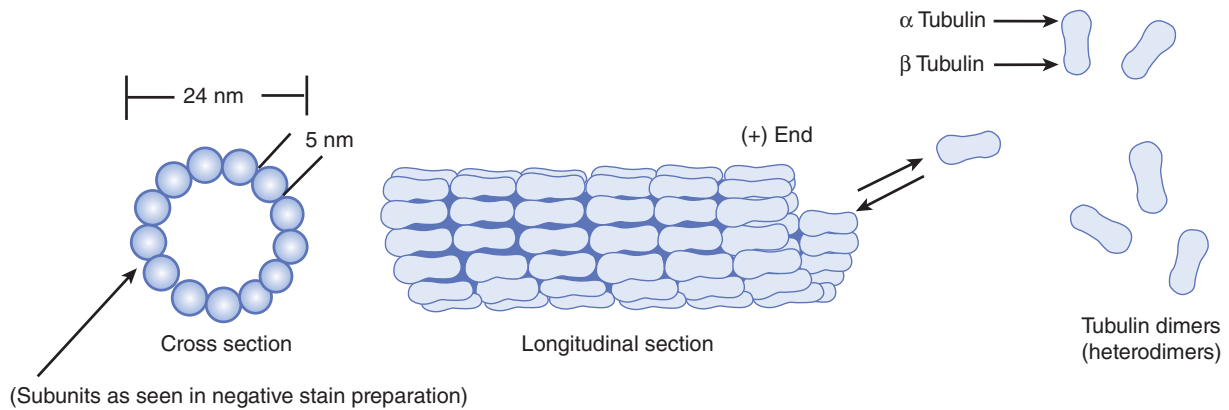

FIGURE 51-17 Schematic representation of microtubules. The upper left-hand corner shows a drawing of microtubules as seen in the electron microscope following fixation with tannic acid in glutaraldehyde. The unstained tubulin subunits are delineated by the dense tannic acid. Cross sections of tubules reveal a ring of 13 subunits of dimers arranged in a spiral. Changes in microtubule length are due to the addition or loss of individual tubulin subunits. Characteristic arrangements of microtubules (not shown here) are found in centrioles, basal bodies, cilia, and flagellae. (Reproduced, with permission, from Junqueira LC, Carneiro J, Kelley RO: *Basic Histology*, 7th ed. Appleton & Lange, 1992.)

two types of actin in nonmuscle cells: β -actin and γ -actin. Both types can coexist in the same cell and probably even copolymerize in the same filament. In the cytoplasm, **F-actin** forms **microfilaments** of 7 to 9.5 nm that frequently exist as bundles of a tangled-appearing meshwork. These prominent bundles, which just underly the plasma membranes of many cells, are referred to as **stress fibers**. Stress fibers disappear as cell motility increases or upon malignant transformation of cells by chemicals or oncogenic viruses.

Although not organized as in muscle, actin filaments in nonmuscle cells interact with **myosin** to cause cellular movements.

Microtubules Contain α - & β -Tubulins

Microtubules, an integral component of the cellular cytoskeleton, consist of cytoplasmic tubes 25 nm in diameter and often of extreme length (Figure 51-17). Microtubules are necessary for the formation and function of the **mitotic spindle** and thus are present in all eukaryotic cells. They are also involved in the intracellular movement of endocytic and exocytic **vesicles** and form the major structural components of **cilia** and **flagella**. Microtubules are a major component of **axons** and **dendrites**, in which they maintain structure and participate in the axoplasmic flow of material along these neuronal processes.

Microtubules are cylinders of 13 longitudinally arranged protofilaments, each consisting of dimers of **α -tubulin** and **β -tubulin**, closely related proteins of approximately 50 kDa molecular mass. The tubulin dimers assemble into protofilaments and subsequently into sheets and then cylinders. A microtubule-organizing center, located around a pair of centrioles, nucleates the growth of new microtubules. A third species of tubulin, **γ -tubulin**, appears to play an important role in this assembly. **GTP** is required for assembly. A variety of proteins are associated with microtubules (**microtubule-associated proteins [MAPs]**), one of which is **tau** and play important roles in microtubule assembly and stabilization. Microtubules are in a

state of dynamic instability, constantly assembling and disassembling. They exhibit **polarity** (plus and minus ends); this is important in their growth from centrioles and in their ability to direct intracellular movement. For instance, in axonal transport, the protein **kinesin**, with a myosin-like ATPase activity, uses hydrolysis of ATP to move vesicles down the axon toward the positive end of the microtubular formation. Flow of materials in the opposite direction, toward the negative end, is powered by **cytosolic dynein**, another protein with ATPase activity. Similarly, **axonemal dyneins** power ciliary and flagellar movement. Another protein, **dynamamin**, uses GTP and is involved in endocytosis. Kinesins, dyneins, dynamamin, and myosins are referred to as **molecular motors**.

An absence of dynein in cilia and flagella results in immobile cilia and flagella, leading to male sterility, situs inversus and chronic respiratory infection, a condition known as **Kartagener syndrome** (OMIM 244400). Mutations in genes affecting the synthesis of dynein have been detected in individuals with this syndrome.

Certain **drugs** bind to microtubules and thus interfere with their assembly or disassembly. These include **colchicine** (used for treatment of acute gouty arthritis), **vinblastine** (a vinca alkaloid used for treating certain types of cancer), **paclitaxel** (Taxol) (effective against ovarian cancer), and **griseofulvin** (an antifungal agent).

Intermediate Filaments Differ from Microfilaments & Microtubules

An intracellular fibrous system exists of filaments with an axial periodicity of 21 nm and a diameter of 8 to 10 nm that is intermediate between that of microfilaments (6 nm) and microtubules (23 nm). At least four classes of **intermediate filaments** are found, as indicated in Table 51-14.

They are all elongated, fibrous molecules, with a central rod domain, an amino terminal head, and a carboxyl terminal tail.

They form a structure like a rope, and the mature filaments are composed of tetramers packed together in a helical manner. They are important structural components of cells, and most are **relatively stable** components of the cytoskeleton, not undergoing rapid assembly and disassembly and not disappearing during mitosis, as do actin and many microtubular filaments.

An important exception to this is provided by the **lamins**, which, subsequent to phosphorylation, disassemble at mitosis and reappear when it terminates. **Lamins** form a meshwork in positioned in apposition to the inner nuclear membrane.

Mutations in the gene encoding **lamin A** and **lamin C** cause Hutchinson-Gilford progeria syndrome (**progeria**) [OMIM 176670], characterized by the appearance of **accelerated aging** and other features. A farnesylated form (see Figure 26–2 for the structure of farnesyl) of prelamin A accumulates in this condition, because the site at which the farnesylated portion of lamin A is normally cleaved by proteases has been altered by mutation. Lamin A is an important component of the structural scaffolding that maintains the integrity of the nucleus of a cell. It appears that the accumulation of farnesylated prelamin A destabilizes nuclei, altering their shape, somehow predisposing victims to manifest signs of premature aging. Experiments in mice have indicated that administration of a farnesyltransferase inhibitor may ameliorate the development of misshapen nuclei. Children affected by this condition often die in their teens of atherosclerosis. A brief scheme of the causation of progeria is shown in **Figure 51–18**.

Keratins form a large family, with about 30 members being distinguished. As indicated in **Table 51–14**, two major types of keratins are found; all individual keratins are **heterodimers** made up of one member of each class.

Vimentins are widely distributed in mesodermal cells, and desmin, glial fibrillary acidic protein, and peripherin are related to them. All members of the vimentin-like family can copolymerize with each other.

Intermediate filaments are very prominent in nerve cells; neurofilaments are classified as low, medium, and high on the basis of their molecular masses. The **distribution of intermediate filaments** in normal and abnormal (eg, cancer) cells can

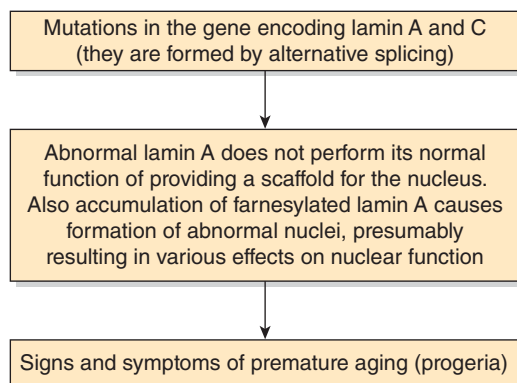

FIGURE 51–18 Scheme of the causation of progeria (Hutchinson–Gilford syndrome, OMIM 176670).

be studied by the use of immunofluorescent techniques, using antibodies of appropriate specificities. These antibodies to specific intermediate filaments can also be of use to pathologists in helping to decide the origin of certain dedifferentiated malignant tumors. These tumors may still retain the type of intermediate filaments found in their cell of origin.

A number of **skin diseases**, mainly characterized by blistering, have been found to be due to mutations in genes encoding **various keratins**. Two of these disorders are epidermolysis bullosa simplex (OMIM 131800) and epidermolytic palmoplantar keratoderma (OMIM 144200). The **blistering** found in these disorders probably reflects a diminished capacity of various layers of the skin to resist mechanical stresses due to abnormalities in the keratin structure.

SUMMARY

- The myofibrils of skeletal muscle contain thick and thin filaments. The thick filaments contain myosin. The thin filaments contain actin, tropomyosin, and the troponin complex (troponins T, I, and C).
- The sliding filament cross-bridge model is the foundation of current thinking about muscle contraction. The basis of this model is that the interdigitating filaments slide past one another during contraction with cross bridges between myosin and actin generating and sustaining tension.
- The hydrolysis of ATP is used to drive movement of the filaments. ATP binds to myosin heads and is hydrolyzed to ADP and P_i by the ATPase activity of the actomyosin complex.
- Ca^{2+} plays a key role in the initiation of contraction in striated muscle by binding to troponin C. In skeletal muscle, the SR regulates distribution of Ca^{2+} to the sarcomeres, whereas inflow of Ca^{2+} via Ca^{2+} channels in the sarcolemma is of major importance in cardiac and smooth muscle.
- Many cases of malignant hyperthermia in humans are due to mutations in the gene encoding the Ca^{2+} release channel.
- A number of differences exist between skeletal and cardiac muscle; in particular, the latter contains a variety of receptors on its surface.
- Some cases of familial hypertrophic cardiomyopathy are due to missense mutations in the gene coding for the β -myosin heavy chain. Mutations in genes encoding a number of other proteins have also been detected.
- Smooth muscle, unlike skeletal and cardiac muscle, does not contain the troponin system; instead, phosphorylation of myosin light chains initiates contraction.
- NO is a regulator of vascular smooth muscle; blockage of its formation from arginine causes an acute elevation of blood pressure, indicating that regulation of blood pressure is one of its many functions.
- Duchenne-type muscular dystrophy is due to mutations in the gene, located on the X chromosome, encoding the protein dystrophin.
- Two major types of muscle fibers are found in humans: white (anaerobic) and red (aerobic). The former are particularly used in sprints and the latter in prolonged aerobic exercise. During a sprint, muscle uses creatine phosphate and glycolysis as energy

sources; in the marathon, oxidation of fatty acids is of major importance during the later phases.

- Nonmuscle cells perform various types of mechanical work carried out by the structures constituting the cytoskeleton. These structures include actin filaments (microfilaments), microtubules (composed primarily of α -tubulin and β -tubulin), and intermediate filaments. The latter include lamins, keratins, vimentin-like proteins, and neurofilaments. Mutations in the gene encoding lamin A cause progeria, a condition characterized by the appearance of premature aging. Mutations in genes for certain keratins cause a number of skin diseases.

REFERENCES

- Barrett KE, Barman SM, Boitano S, et al: *Ganong's Review of Medical Physiology*, 24th ed. McGraw-Hill Lange, 2012.
- Blanchoin L, Bouiemaa-Paterski R, Sykes C, Plastino J: Actin dynamics, architecture, and mechanics in cell motility. *Physiol Rv* 2014;94:235.
- Brosnan JT, Brosnan ME: Creatine: endogenous metabolite, dietary and therapeutic supplement. *Annu Rev Nutr* 2007;27:241.
- Cooper GM, Hausman RE: *The Cell: A Molecular Approach*, 5th ed. Sinauer Associates Inc., 2009.
- Kull FJ, Endow SA: Force generation by kinesin and myosin cytoskeleton proteins. *J Cell Sci* 2013;126:9.
- Murad F: Nitric oxide and cyclic GMP in cell signalling and drug development. *N Engl J Med* 2006;355:2003.
- Murphy RT, Starling RC: Genetics and cardiomyopathy: where are we now? *Cleve Clin J Med* 2005;72:465.
- Neubauer S: The failing heart—an engine out of fuel. *N Engl J Med* 2007;356:1140.
- Pritchard RH, Shery Huang YY, Terentiev EM: Mechanics of biological networks: from the cell cytoskeleton to connective tissue. *Soft Matter* 2014;10:1864.
- Sanders KM: Regulation of smooth muscle excitation and contraction. *Neurogastroenterol Motil* 2008;20 Suppl 1:39.
- Scriver CR, Beaudet AL, Valle D, et al (editors): *The Metabolic and Molecular Bases of Inherited Disease*, 8th ed. McGraw-Hill, 2001.
- Sequeira V, Nijenkamp LL, Regan JA, van der Velden J: The physiological role of cardiac cytoskeleton and its alterations in heart failure. *Biochim Biophys Acta* 2014;1838:700.
- Sweeney HL, Houdusse A: Structural and functional insights into the myosin motor mechanism. *Annu Rev Biophys* 2010;39:539.
- Taimen P, Pfliegerhaer K, Shimi T, et al: A progeria mutation reveals functions for lamin A in nuclear assembly, architecture, and chromosome organization. *Proc Natl Acad Sci USA* 2009;106(49):20788.

Plasma Proteins & Immunoglobulins

Peter J. Kennelly, PhD, Robert K. Murray, MD, PhD, Molly Jacob, MBBS, MD, PhD & Joe Varghese, MBBS, MD

OBJECTIVES

After studying this chapter, you should be able to:

- List the major functions of blood.
- Describe the principal functions of serum albumin.
- Explain how haptoglobin protects the kidney against formation of damaging iron precipitates.
- Describe the roles of ferritin, transferrin, and ceruloplasmin in iron homeostasis.
- Describe the mechanism by which transferrin, transferrin receptors, and HFE protein interact to regulate synthesis of hepcidin, a key regulator of iron homeostasis.
- Explain how iron homeostasis can be perturbed by dietary deficiencies or certain disorders.
- Describe the general structures and functions of the five classes of immunoglobulins and the uses of monoclonal antibodies.
- Explain how our bodies are able to synthesize up to a million different immunoglobulins utilizing fewer than 150 genes.
- Describe the how the complement system becomes activated and subsequently lyses invading microorganisms.
- Explain how the body's adaptive immune system differs from its innate immune system.
- Define the term lectin.
- Outline the key differences between polyclonal and monoclonal antibodies.
- Explain the salient features of autoimmune and immunodeficiency disorders.

BIOMEDICAL IMPORTANCE

The proteins that circulate in blood plasma play important roles in human physiology. **Albumins** facilitate the transit of fatty acids, steroid hormones, and other ligands between tissues. **Transferrin** aids the uptake and distribution of iron, a component of many critically important metalloproteins. Circulating **fibrinogen** serves as a readily mobilized building block of the fibrin mesh that provides the foundation of the clots used to seal injured vessels. Clot formation is triggered by a cascade of blood coagulation factors, latent proteases that normally circulate as inactive proproteins, or **zymogens**. Plasma also contains several proteins that function as inhibitors of proteolytic enzymes. **Antithrombin** helps confine the formation of clots to the vicinity of a wound, while α_1 -antitrypsinase

and α_2 -macroglobulin prevent the proteases used to destroy invading pathogens and dead or defective cells from damaging healthy tissue. Circulating immunoglobulins called **antibodies** form the front line of the body's immune system.

Perturbances in the production of plasma proteins can have serious health consequences. Deficiencies in key components of the blood clotting cascade can result in excessive bruising and bleeding (**hemophilia**). Persons lacking plasma ceruloplasmin, the body's primary carrier of copper, are subject to hepatolenticular degeneration (Wilson disease), while emphysema is associated with a genetic deficiency in the production of circulating α_1 -antitrypsinase. Aberrant production of immunoglobulins characterizes the numerous **autoimmune disorders**, such as type-1 diabetes, asthma, and rheumatoid arthritis, that affect more than one in every thirty

TABLE 52-1 Prevalence of Selected Autoimmune Diseases Among U.S. Population

Autoimmune Disease	Mean Prevalence Rate (per 100,000)	Percentage Female
Graves disease/hyperthyroidism	1152	88
Rheumatoid arthritis	860	75
Thyroiditis/hypothyroidism	792	95
Vitiligo	400	52
Type 1 diabetes	192	48
Pernicious anemia	151	67
Multiple sclerosis	58	64
Primary glomerulonephritis	40	32
Systemic lupus erythematosus	24	88
IgA glomerulonephritis	23	67
Sjogren syndrome	14	94
Myasthenia gravis	5	73
Addison's disease	5	93
Schleroderma	4	92

Source: Data from Jacobson DL, Gange SJ, Rose NR, Graham NMH: Epidemiology and estimated population burden of selected autoimmune diseases in the United States. *J Clin Immunol Immunopathol* 1997;84:223.

residents of North America (Table 52-1). Insufficiencies in the production of protective antibodies, such as occur in many persons infected by the **human immunodeficiency virus** (HIV) or patients administered immunosuppressant drugs, renders them immunocompromised, extremely susceptible to infection by microbial and viral pathogens, and vulnerable to their spread. While the root causes of plasma protein-related diseases such as hemophilia are relatively straightforward, others—in particular many autoimmune disorders—arise due to the complex and cryptic interplay of genetic, dietary, nutritional, environmental, and medical factors.

THE BLOOD HAS MANY FUNCTIONS

As the primary avenue by which tissues are connected to each other and the surrounding environment, the blood that circulates throughout our body performs a variety of functions. These include delivering nutrients and oxygen, removing waste products, conveying hormones, and defending against infectious microorganisms (Table 52-2). These myriad functions are carried out by a diverse set of components that include cellular entities such as red blood cells, platelets, and leukocytes (see Chapters 53 and 54), and the water, electrolytes, metabolites, nutrients, proteins, and hormones that comprise the **plasma**.

TABLE 52-2 Major Functions of Blood

1. Respiration —transport of oxygen from the lungs to the tissues and of CO ₂ from the tissues to the lungs
2. Nutrition —transport of absorbed food materials
3. Excretion —transport of metabolic waste to the kidneys, lungs, skin, and intestines for removal
4. Maintenance of the normal acid-base balance in the body
5. Regulation of water balance through the effects of blood on the exchange of water between the circulating fluid and the tissue fluid
6. Regulation of body temperature by the distribution of body heat
7. Defense against infection by the white blood cells and circulating antibodies
8. Transport of hormones and regulation of metabolism
9. Transport of metabolites
10. Coagulation

PLASMA CONTAINS A COMPLEX MIXTURE OF PROTEINS

Plasma contains a complex mixture of proteins, many of which contain high numbers of disulfide bonds as well as covalently bound carbohydrate (**glycoproteins**) or lipid (**lipoproteins**). Based upon their relative solubility in the presence of an organic solvent such as ethanol, or salting out agents such as ammonium sulfate, early researchers separated plasma proteins into three groups: **fibrinogen**, **albumin**, and **globulins**. Subsequently, clinical scientists employed electrophoresis within a **cellulose acetate** matrix to analyze the protein composition of plasma. Following electrophoretic separation, staining reagents revealed five major bands that were designated **albumin**, α_1 , α_2 , β , and γ **fractions**, respectively (Figure 52-1). The relative dimensions and molecular masses of several plasma proteins are shown in Figure 52-2.

Plasma Proteins Help Determine the Distribution of Fluid Between Blood & Tissues

The aggregate concentration of the proteins present in plasma typically falls in the range of 7.0 to 7.5 g/dL for humans. The **osmotic pressure** (oncotic pressure) exerted by the plasma proteins is approximately 25 mm Hg. Since the **hydrostatic pressure** in the arterioles is approximately 37 mm Hg, with an interstitial (tissue) pressure of 1 mm Hg opposing it, a net outward force of about 11 mm Hg drives fluid out into the interstitial spaces. In venules, the hydrostatic pressure is about 17 mm Hg, with the oncotic and interstitial pressures as described above; thus, a net force of about 9 mm Hg attracts water back into the circulation. The above pressures are often referred to as the **Starling forces**. If the concentration of plasma proteins is markedly diminished (eg, due to severe protein malnutrition), fluid will no longer flow back into the intravascular compartment. The resulting accumulation of fluid in the extravascular tissue spaces results in a condition known as **edema**.

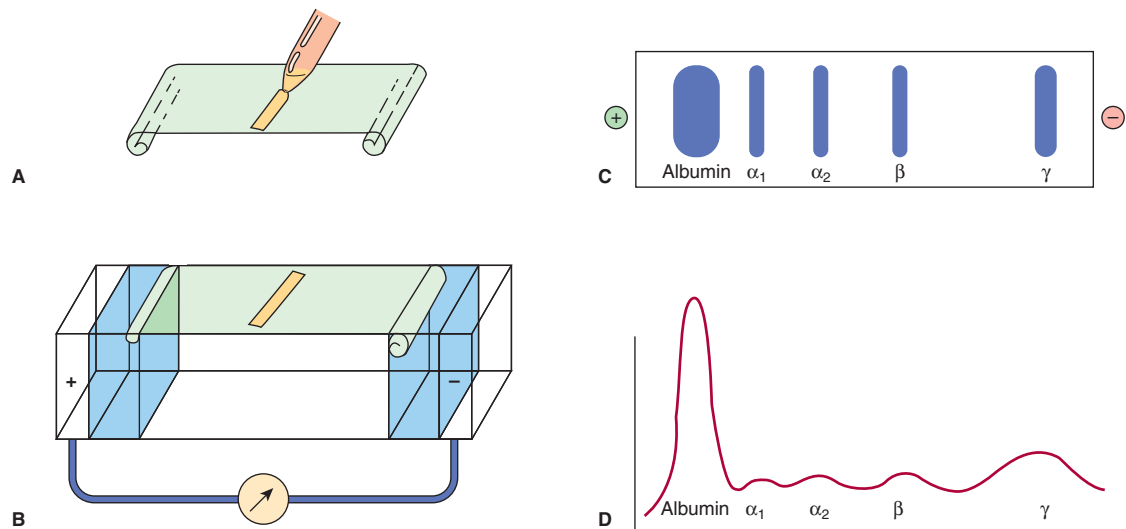

FIGURE 52-1 Technique of cellulose acetate zone electrophoresis. (A) A small amount of serum or other fluid is applied to a cellulose acetate strip. (B) Electrophoresis in electrolyte buffer is performed. (C) Staining enables separated bands of protein to be visualized. (D) Densitometer scanning reveals the relative mobilities of albumin, α_1 -globulin, α_2 -globulin, β -globulin, and γ -globulin. (Reproduced, with permission, from Parslow TG et al (editors): *Medical Immunology*, 10th ed. McGraw-Hill, 2001.)

Most Plasma Proteins Are Synthesized in the Liver

Roughly 70% to 80% of all plasma proteins are synthesized in the liver. These include albumin, fibrinogen, transferrin, and most components of the complement and blood coagulation cascade with the exception of von Willebrand factor, which

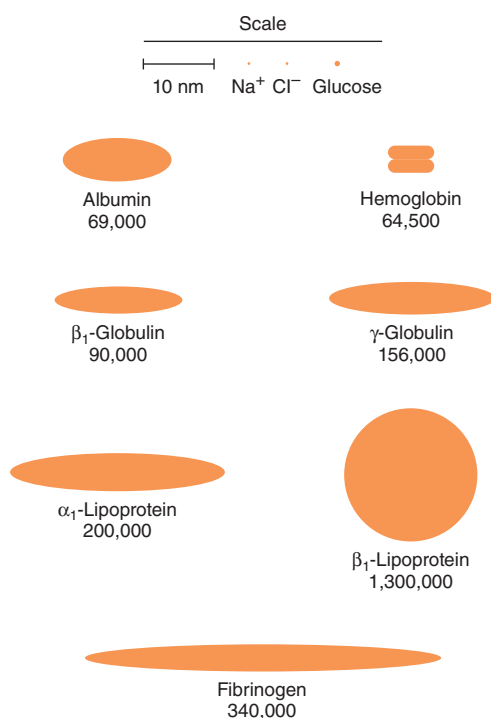

FIGURE 52-2 Relative dimensions and approximate molecular masses of protein molecules in the blood.

is synthesized in the vascular endothelium. One prominent exception is the γ -globulins, which are synthesized in the lymphocytes. Most plasma proteins are covalently modified by the addition of either N- or O-linked oligosaccharide chains, or both (see Chapter 46). Albumin is the major exception. These oligosaccharide chains have perform various functions (see Table 46-2). Loss of terminal sialic acid residues accelerates clearance of plasma glycoproteins from the circulation.

As is the case for other proteins destined for secretion from a cell, the genes for plasma proteins code for an amino-terminal **signal sequence** that targets them to the endoplasmic reticulum. As this leader sequence emerges from the ribosome, it binds to a transmembrane protein complex in the endoplasmic reticulum called the **signal recognition particle**. The emerging polypeptide chain is pulled through the signal recognition particle into the lumen of the endoplasmic reticulum, during which process the leader sequence is cleaved off by an associated **signal peptidase** (see Chapter 49). The newly synthesized proteins then traverse the major secretory route in the cell (rough endoplasmic membrane \rightarrow smooth endoplasmic membrane \rightarrow Golgi apparatus \rightarrow secretory vesicles) prior to entering the plasma, during which process they are subject to various posttranslational modifications (proteolysis, glycosylation, phosphorylation, etc). Transit times through the hepatocyte from the site of synthesis to the plasma vary from 30 minutes to several hours for individual proteins.

Many Plasma Proteins Exhibit Polymorphism

A **polymorphism** is a Mendelian or monogenic trait that exists in the population in at least two phenotypes, neither of which is rare (ie, neither of which occurs with frequency of <1%-2%). The ABO blood group substances (see Chapter 53)

are the best known examples of human polymorphisms. Other human plasma proteins that exhibit polymorphism include α_1 -antitrypsin, haptoglobin, transferrin, ceruloplasmin, and immunoglobulins. Most polymorphisms are innocuous.

Each Plasma Protein Has a Characteristic Half-Life in the Circulation

The **half-life** of a plasma protein is the time required for 50% of the molecules present at any given moment to be degraded or otherwise cleared from the blood. Under normal circumstances, the resulting **turnover**, or replacement, of older protein molecules with newly synthesized ones occurs without any change in their total concentration. In other words, the countervailing processes of synthesis and clearance reach a **steady state** where no net increase or decrease is evident at the gross, or macromolecular, level.

The half-lives of albumin and haptoglobin in normal healthy adults are approximately 20 and 5 days, respectively. In certain diseases, the half-life of a protein may be markedly altered. For instance, in some gastrointestinal diseases such as regional ileitis (Crohn disease), considerable amounts of plasma proteins, including albumin, may be lost into the bowel through the inflamed intestinal mucosa. Patients with this condition have a **protein-losing gastroenteropathy**. The half-life of albumin in these subjects may be reduced to as little as 1 day.

ALBUMIN IS THE MAJOR PROTEIN IN HUMAN PLASMA

The liver synthesizes approximately 12 g of albumin per day, representing about 25% of total hepatic protein synthesis and half its secreted protein. About 40% of the body's albumin circulates in the plasma, where it accounts for roughly three-fifths of total plasma protein by weight (3.4–4.7 g/dL). The remainder resides in the extracellular space. Because of its relatively low molecular mass (about 69 kDa) and high concentration, albumin is thought to be responsible for 75% to 80% of the **osmotic pressure** of human plasma. Like most other secreted proteins, albumin is initially synthesized as a **preproprotein**. Its **signal peptide** is removed as it passes into the cisternae of the rough endoplasmic reticulum, and a **hexapeptide** at the resulting amino terminal is subsequently cleaved off farther along the secretory pathway (see Figure 49–12).

Mature human albumin consists of a single polypeptide chain 585 amino acids in length that is organized into three functional domains. Its ellipsoidal conformation is stabilized by a total of 17 intrachain disulfide bonds. One of the major roles of albumin is to bind to and thereby facilitate the transport of numerous **ligands**. These include free fatty acids (FFA), calcium, certain steroid hormones, bilirubin, copper, and some of the plasma tryptophan. A variety of drugs, including sulfonamides, penicillin G, dicumarol, and aspirin, are bound to albumin; this finding has important pharmacologic implications. Preparations of human albumin have been widely used in the treatment of burns and of hemorrhagic shock.

Certain humans suffer from genetic mutations that impair their ability to synthesize albumin. Individuals whose plasma is completely devoid of albumin are said to exhibit **analbuminemia**. Although albumin is normally the major determinant of plasma osmotic pressure, persons suffering from analbuminemia show only moderate edema. Depressed synthesis of albumin occurs in a variety of diseases, particularly those of the liver. The plasma of patients with **liver disease** often shows a decrease in the ratio of albumin to globulins (decreased albumin-globulin ratio). The synthesis of albumin decreases relatively early in conditions of protein malnutrition, such as **kwashiorkor**.

THE LEVELS OF CERTAIN PLASMA PROTEINS INCREASE DURING INFLAMMATION OR FOLLOWING TISSUE DAMAGE

Table 52–3 summarizes the functions of many of the plasma proteins. **C-reactive protein** (CRP, so named because it reacts with the C polysaccharide of pneumococci), α_1 -antiproteinase, haptoglobin, α_1 -acid glycoprotein, and fibrinogen are classified as “**acute-phase proteins**.” Acute phase proteins are believed to play a role in the body's response to inflammation. C-reactive protein can stimulate the classic complement pathway (see below), while α_1 -antitrypsin neutralizes certain proteases released during the acute inflammatory state.

The levels of acute-phase proteins may increase from 50% to as much as 1000-fold (in the case of CRP) during chronic inflammatory states and in patients with cancer. **Interleukin-1 (IL-1)**, a polypeptide released from mononuclear phagocytic cells, is the principal—but not the sole—stimulator of the synthesis of the majority of acute phase reactants by hepatocytes. Additional molecules such as IL-6 are involved. Because its concentration can rise so dramatically, CRP is used as a biomarker of tissue injury, infection, and inflammation.

Cytokines are small proteins such as interferons, interleukins (IL), and tumor necrosis factors that facilitate cell-cell communication between the components of the immune system. They can be both autocrine and paracrine in nature. Cytokines IL-1 and IL-6 work at the level of gene transcription. One of their primary targets is a transcription factor called **nuclear factor kappa-B (NF κ B)**, which also regulates the expression of the genes encoding many cytokines, chemokines, growth factors, and cell adhesion molecules. NF κ B, a heterodimer comprised of a 50- and a 65-kDa polypeptide, normally resides in the cytosol as an inactive complex with a second protein, NF κ B inhibitor- α , also known as **I κ B α** . Upon stimulation in response to inflammation, injury, or radiation, I κ B α is phosphorylated, then ubiquitinated and degraded. Once freed from its inhibitory partner, active NF κ B translocates to the nucleus where it stimulates transcription of its target genes.

TABLE 52-3 Some Functions of Plasma Proteins

Function	Plasma Proteins
Antiproteases	Antichymotrypsin α_1 -Antitrypsin (α_1 -antiproteinase) α_2 -Macroglobulin Antithrombin
Blood clotting	Various coagulation factors, fibrinogen
Enzymes	Function in blood, for example, coagulation factors, cholinesterase Leakage from cells or tissues, eg, aminotransferases
Hormones	Erythropoietin ^a
Immune defense	Immunoglobulins, complement proteins, and β_2 -macroglobulin
Involvement in inflammatory responses	Acute phase response proteins (eg, C-reactive protein, α_1 -acid glycoprotein [orosomucoid])
Oncofetal	α_1 -Fetoprotein (AFP)
Transport or binding proteins	Albumin (various ligands, including bilirubin, free fatty acids, ions [Ca^{2+}], metals [eg, Cu^{2+} , Zn^{2+}], metheme, steroids, other hormones, and a variety of drugs) Corticosteroid-binding globulin (transcortin) (binds cortisol) Haptoglobin (binds extracorporeal hemoglobin) Lipoproteins (chylomicrons, VLDL, LDL, HDL) Hemopexin (binds heme) Retinol-binding protein (binds retinol) Sex-hormone-binding globulin (binds testosterone, estradiol) Thyroid-binding globulin (binds T_4 , T_3) Transferrin (transport iron) Transthyretin (formerly prealbumin; binds T_4 and forms a complex with retinol-binding protein)

^aVarious other protein hormones circulate in the blood but are not usually designated as plasma proteins. Similarly, ferritin is also found in plasma in small amounts, but it too is not usually characterized as a plasma protein.

HAPTOGLOBIN PROTECTS THE KIDNEYS FROM DAMAGE BY EXTRACORPUSCULAR HEMOGLOBIN

Iron in Senescent Erythrocytes Is Recycled by Macrophages

Erythrocytes normally have a lifespan of approximately 120 days. Senescent or damaged erythrocytes are phagocytosed by macrophages of the reticuloendothelial system (RES) present in the spleen and liver. Around 200 billion erythrocytes

(in about 40 mL of blood) are catabolized every day in this way. Within the macrophage, heme derived from hemoglobin is broken down by **heme oxygenase**, converting it to biliverdin (see Figure 31-13). Carbon monoxide and iron are released as by-products. Iron released from heme is exported from the phagocytic vesicle in the macrophage by **NRAMP 1** (natural resistance-associated macrophage protein 1), a transporter homologous to DMT1. It is subsequently transported into the circulation by the transmembrane protein ferroportin (Figure 52-3). Therefore, ferroportin plays a central role, not only in iron absorption in the intestine, but also in iron release from macrophages. **Ceruloplasmin** (see below), a copper-containing plasma protein synthesized by liver, is a ferroxidase required for the oxidation of Fe^{2+} to Fe^{3+} . Fe^{3+} is then bound to transferrin in blood. The iron released from macrophages in this way (about 25 mg/d) is recycled and forms the major source of iron for the body. In comparison, intestinal iron absorption contributes only 1 to 2 mg of the body's daily iron needs.

Haptoglobin Scavenges Hemoglobin That Has Escaped Recycling

During the course of red blood cell turnover, approximately 10% of an erythrocyte's hemoglobin is released into the circulation. This free, **extracorporeal** hemoglobin is sufficiently small at ≈ 65 kDa to pass through the glomerulus of the kidney into the tubules, where it tends to form damaging precipitates. **Haptoglobin** (Hp) is a plasma glycoprotein that binds extra-corporeal hemoglobin (Hb) to form a tight non-covalent complex (Hb-Hp). Since the Hb-Hp complex is too large (≥ 155 kDa) to pass through the glomerulus, this protects

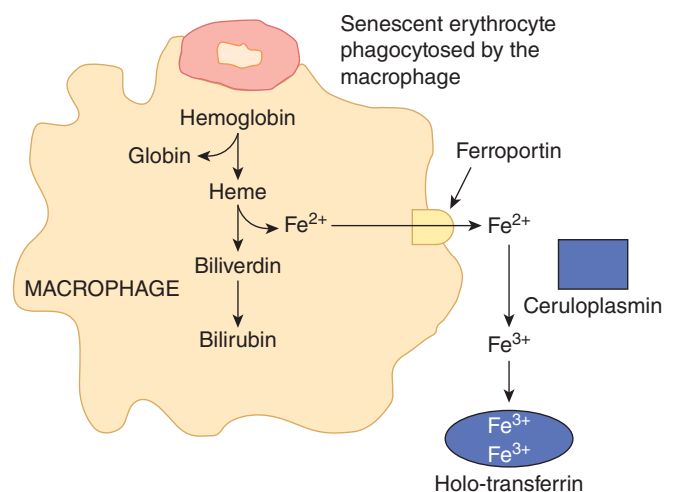

FIGURE 52-3 Recycling of iron in macrophages. Senescent erythrocytes are phagocytosed by macrophages. Hemoglobin is degraded and iron is released from heme by the action of the enzyme heme oxygenase. Ferrous iron is then transported out of the macrophage via ferroportin (Fp). In the plasma, it is oxidized to the ferric form by ceruloplasmin before binding to transferrin (Tf). Iron circulates in blood tightly bound to Tf.

the kidney from the formation of harmful precipitates and reduces the loss of the iron associated with extracorporeal hemoglobin.

Haptoglobin Has Polymorphic Forms

Human haptoglobin exists in **three polymorphic forms**, known as Hp 1-1, Hp 2-1, and Hp 2-2. Hp 1-1 migrates during electrophoresis on a starch gel as a single band, whereas Hp 2-1 and Hp 2-2 exhibit more complex band patterns. Two genes, designated *Hp¹* and *Hp²*, direct these three phenotypes, with Hp 2-1 being the heterozygous phenotype.

The level of haptoglobin in human plasma is typically sufficient to bind 40 to 180 mg of hemoglobin per deciliter. Variations beyond the norm can sometimes serve as useful diagnostic indicators. For example, haptoglobin is an acute phase protein, and its plasma level is elevated in a variety of inflammatory states. Patients suffering from **hemolytic anemias** exhibit low levels of haptoglobin. This is because, while the half-life of haptoglobin is approximately 5 days, the Hb-Hp complex is removed rapidly by the hepatocytes (half-life 90 minutes). Thus, when haptoglobin is bound to hemoglobin, it is cleared from the plasma about 80 times faster than normally. Accordingly, the level of haptoglobin falls rapidly in situations where hemoglobin is constantly being released from red blood cells, such as occurs in hemolytic anemias. The level of **haptoglobin-related protein**, another plasma protein that has a high degree of homology to haptoglobin, is elevated in some patients with cancers, although the significance of this is not understood.

Certain other plasma proteins **bind heme**, but not hemoglobin. **Hemopexin** is a β_1 -globulin that binds free heme. **Albumin** will bind some metheme (ferric heme) to form methemalbumin, which then transfers the metheme to hemopexin.

IRON IS STRICTLY CONSERVED

Iron is a key constituent of many human proteins, including hemoglobin, myoglobin, cytochrome P450 group of enzymes, numerous components of the electron transport chain, and ribonucleotide reductase, which catalyzes the conversion of ribonucleotides into deoxyribonucleotides. Body iron, which is distributed as shown in **Table 52-4**, is highly conserved. A healthy adult loses only about 1.0 to 1.5 mg (<0.05%) of their 3 to 4 g of body iron each day. However, an adult premenopausal female can experience iron deficiency due to blood loss during menstruation.

Absorption of nonheme iron by enterocytes of the proximal duodenum is a highly regulated process (**Figure 52-4**). **Inorganic dietary iron** in the ferric state (Fe^{3+}) is reduced to its ferrous form (Fe^{2+}) by a brush border membrane-bound ferrireductase, **duodenal cytochrome b (Dcytb)**. Vitamin C, gastric acid, and a number of other reducing agents present in food may also favor reduction of ferric to ferrous iron. The transfer of iron across the apical membrane of the enterocytes is accomplished via the **divalent metal transporter 1 (DMT1 or SLC11A2)**. DMT1 is relatively nonspecific, and may also be

TABLE 52-4 Distribution of Iron in a 70-kg Adult Male^a

Transferrin	3-4 mg
Hemoglobin in red blood cells	2500 mg
In myoglobin and various enzymes	300 mg
In stores (ferritin)	1000 mg
Absorption	1 mg/d
Losses	1 mg/d

^aIn an adult female of similar weight, the amount in stores would generally be less (100-400 mg) and the losses would be greater (1.5-2 mg/d).

involved in the transport of other divalent cations, such as Mn^{2+} , Co^{2+} , Zn^{2+} , Cu^{2+} , and Pb^{2+} . Once inside the enterocytes, iron can either be stored bound to the iron storage protein **ferritin** or transferred across the basolateral membrane into the circulation by the iron exporter protein, **ferroportin** or **iron-regulated protein 1 (IREG1 or SLC40A1)**. **Hephaestin**, a copper-containing ferroxidase homologous to ceruloplasmin, oxidizes Fe^{2+} to Fe^{3+} prior to export. Iron is transported in plasma in the Fe^{3+} form by the transport protein, **transferrin**. Any excess ferritin-bound iron retained by the enterocytes is disposed of when the enterocytes are sloughed off into the gut lumen.

Dietary iron that is ingested as heme is taken up by a distinct mechanism. Following absorption by the enterocytes, iron is released from heme by the enzymatic action of heme oxygenase (see Chapter 31). Once released, the iron is either stored in association with ferritin or transported into circulation by ferroportin.

Ferritin Can Bind Thousands of Fe^{3+} Atoms

The human body can typically store up to 1 g of iron, the vast majority of which is bound to **ferritin**. Ferritin (MW 440 kDa) is composed of 24 identical subunits, which surround as many as 3000 to 4500 ferric atoms. The subunits may be of the H (heavy) or the L (light) type. The H-subunit possesses ferroxidase activity, which is required for iron-loading of ferritin. The function of the L subunit is not clearly known but is proposed to play a role in ferritin nucleation and stability. Normally, there is a small amount of ferritin in human plasma (50-200 $\mu\text{g/dL}$) proportionate to the total stores of iron in the body. Plasma ferritin levels thus are considered to be an **indicator of body iron stores**. However, it is not known whether ferritin in plasma is derived from damaged cells or secretion by healthy ones.

Hemosiderin, a partly degraded form of ferritin that contains iron, can be detected in tissues by histological stains (eg, Prussian blue), under conditions of iron overload (**hemosiderosis**).

Transferrin Shuttles Iron to Where It Is Needed

The extreme toxicity of free iron is largely a consequence of its ability to catalyze the formation of damaging reactive oxygen species (**Figure 52-5**). Biological organisms minimize the

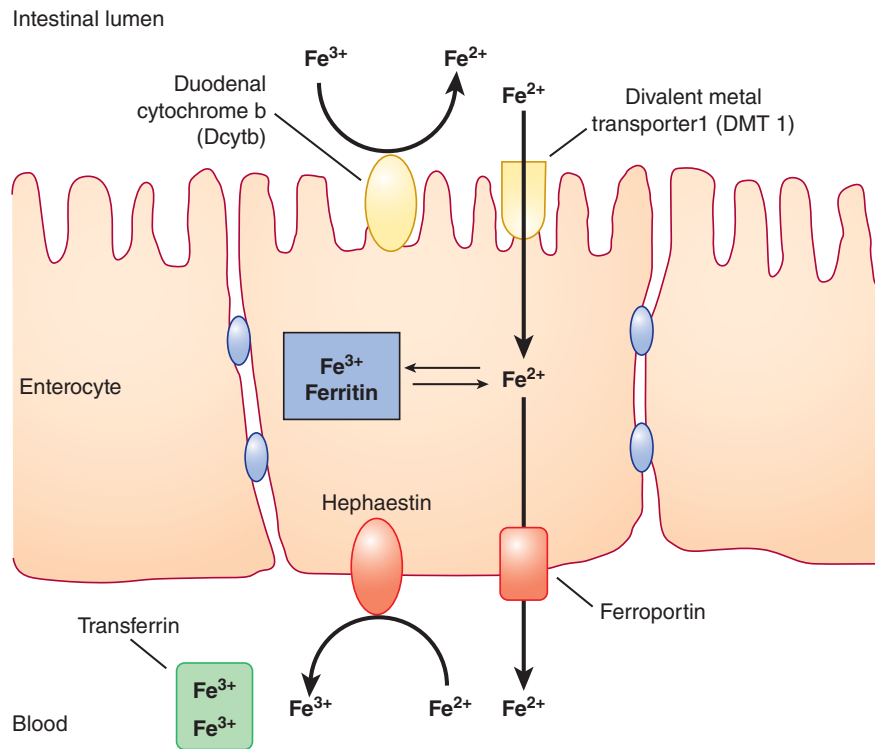

FIGURE 52-4 Nonheme iron transport in enterocytes. Ferric iron is reduced to the ferrous form by a luminal ferrireductase, duodenal cytochrome b (Dcytb). Ferrous iron is transported into the enterocyte via divalent metal transporter-1 (DMT-1). Within the enterocyte, iron is either stored as ferritin, or transported out of the cell by ferroportin (Fp). Ferrous iron is oxidized to its ferric form by hephaestin. The ferric iron is then bound by transferrin for transport by the blood to various sites in the body. (Based on Andrews NC: Forging a field: the golden age of iron biology. *Blood* 2008;112:219.)

potential toxicity of iron by employing specialized storage and transport proteins. In humans, iron is transported through the body tightly bound to the plasma protein **transferrin (Tf)**, a glycoprotein synthesized by the liver. This β_1 -globulin has a molecular mass of approximately 76 kDa and contains two high-affinity binding sites for Fe³⁺. The form of the protein in which both sites are occupied is called **holotransferrin (Tf-Fe)**. Transferrin is a glycoprotein that is synthesized in the liver. The concentration of Tf in plasma is approximately 300 mg/dL, sufficient to carry a total of approximately 300 μ g of iron per deciliter of plasma. This figure represents the **total iron-binding capacity (TIBC)** of plasma. The binding sites in transferrin are not normally fully occupied, or **saturated**. Typically, about 30% of the iron binding sites in transferrin are occupied. Saturation can decrease to less than 16% during

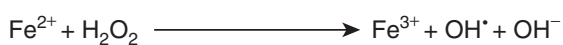

FIGURE 52-5 The Fenton reaction. Free iron is extremely toxic as it can catalyze the formation of hydroxyl radical (OH[•]) from hydrogen peroxide (see also Chapter 53). The hydroxyl radical is a transient but highly reactive species and that oxidize cellular macromolecules resulting in tissue damage.

severe iron deficiency and may increase to more than 45% in iron overload conditions.

Glycosylation of transferrin is impaired in **congenital disorders of glycosylation** (see Chapter 46) as well as in **chronic alcoholism**. The presence of **carbohydrate-deficient transferrin (CDT)**, which can be measured by isoelectric focussing (IEF), is used as a biomarker of chronic alcoholism.

The Transferrin Cycle Facilitates Cellular Uptake of Iron

For the delivery of transported iron, the recipient cell must bind circulating transferrin via a cell surface **transferrin receptor 1 (TfR1)**. The receptor-transferrin complex is then internalized by **receptor-mediated endocytosis** (similar to LDL receptors described in Chapter 25) and bound iron released from the protein as late endosomes become acidified. The dissociated iron leaves the endosome via DMT1 to enter the cytoplasm. Unlike the protein component of LDL, apoTf (Tf without bound iron) is not degraded within the endosome. Instead, it remains associated with its receptor and returns to the plasma membrane. The recycled apoTf then dissociates from its receptor and reenters the plasma, where it picks up more iron for delivery to cells. This is called the **transferrin cycle** (Figure 52-6).

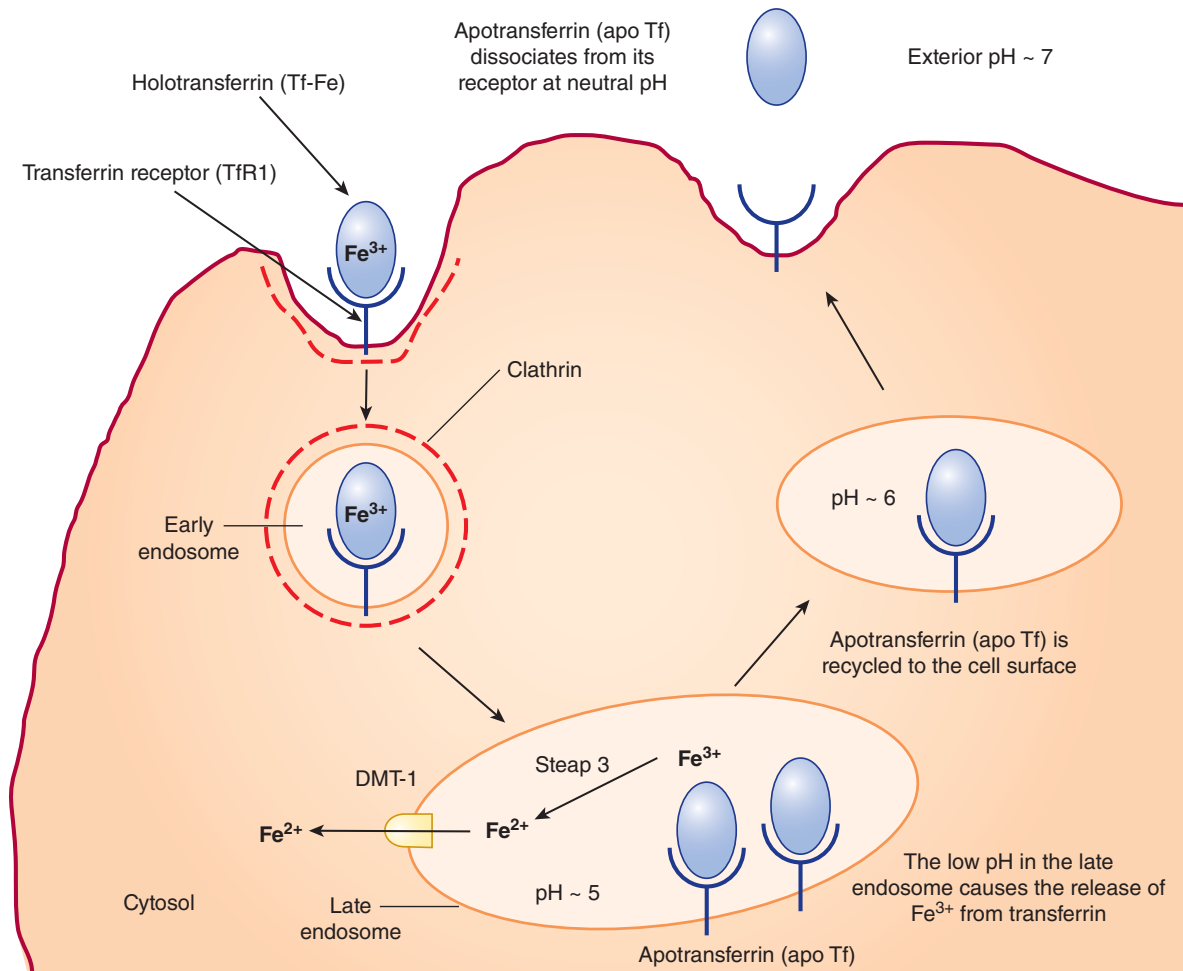

FIGURE 52-6 The transferrin cycle. Holotransferrin (Tf-Fe) binds to transferrin receptor 1 (TfR1) present in clathrin-coated pits on the cell surface. The TfR1-Tf-Fe complex is endocytosed and endocytic vesicles fuse to form early endosomes. The early endosomes mature to late endosomes, which have a low internal pH. These acidic conditions low pH the cause release of iron from transferrin. The resulting apotransferrin (apoTf) remains bound to TfR1. Ferric iron is converted to its ferrous form by the ferrireductase, Steap 3, and is then transported to the cytosol via DMT1. The TfR1-apoTf complex is recycled back to the cell surface. At the cell surface, apoTf is released from TfR1. TfR1 then binds to new Tf-Fe. This completes the transferrin cycle. (Based on Figure 17-48 in Lodish H, et al: *Molecular Cell Biology*, 4th ed. WH Freeman, 2000.)

Transferrin receptor 1 can be found on the surface of most cells. **Transferrin receptor 2 (TfR2)**, by contrast, is expressed primarily on the surface of hepatocytes and also in the crypt cells of the small intestine. The affinity of TfR2 for Tf-Fe is much lower than that of TfR1. The lower affinity of TfR2 optimizes it for its role in sensing, rather than internalizing iron, as discussed later.

Oxidation by Ceruloplasmin Is a Key Feature of the Iron Cycle

Following the destruction of phagocytized red blood cells, the iron released from the macrophages is largely in the ferrous, Fe^{2+} , state. However, in order to be recovered via the transferrin cycle, this iron first must be oxidized to the ferric, Fe^{3+} , state. In the blood, oxidation of ferrous iron is catalyzed by the multicopper ferroxidase **ceruloplasmin**, a 160 kDa α_2 -globulin synthesized by the liver. Ceruloplasmin, which also

is expressed in enterocytes and placenta, is the major copper-containing protein in plasma. Its six tightly bound copper atoms serve as catalytically essential prosthetic groups.

Deficiencies in Ceruloplasmin Perturb Iron Homeostasis

Persons lacking adequate quantities of catalytically active ceruloplasmin in the blood are unable to properly recycle Fe^{2+} , leading to the accumulation of iron in the liver and other tissues. Ceruloplasmin deficiency can arise from genetic causes as well as a lack of copper, an essential micronutrient, in the diet. Persons suffering from **hypoceruloplasminemia**, a genetically heritable condition in which ceruloplasmin levels are roughly 50% of normal, generally display no clinical abnormalities. However, genetic mutations that abolish the ferroxidase activity of ceruloplasmin, **aceruloplasminemia**, can have severe physiologic consequences. If left untreated, the progressive

accumulation of iron in pancreatic islet cells and basal ganglia eventually leads to the development of insulin-dependent diabetes and neurological degeneration that may manifest as dementia, dysarthria, and dystonia.

Ceruloplasmin Levels Increase in Wilson Disease

Serious decreases in the level of ceruloplasmin protein in the serum serve also as a biomarker for **Wilson disease**, a genetic condition in which a mutation in the gene for a **copper-binding P-type ATPase** (ATP7B protein) blocks the excretion of excess copper in the bile. As a consequence, copper accumulates in the liver, brain, kidney, and red blood cells. Paradoxically, rising levels of copper within liver cells apparently interfere with the incorporation of this metal into newly synthesized ceruloplasmin polypeptides (apoceruloplasmin), leading to a fall in plasma ceruloplasmin levels. If left untreated, patients suffering from **copper toxicosis** may develop a hemolytic anemia, chronic liver disease (cirrhosis and hepatitis), and neurologic syndromes owing to accumulation of copper in the basal ganglia and other centers. Wilson disease can be treated by limiting the dietary intake of copper and depleting the body of excess copper by the regular administration of **penicillamine**, which chelates copper and is subsequently excreted in the urine.

INTRACELLULAR IRON HOMEOSTASIS IS TIGHTLY REGULATED

Synthesis of TfR1 and Ferritin Are Reciprocally Regulated

The rates of synthesis of TfR1 and ferritin are reciprocally linked to intracellular iron levels. When iron is low, TfR1 synthesis increases and that of ferritin declines. The opposite occurs when iron is abundant and tissue needs have been sated. Control is exerted through the binding of iron regulatory proteins (IRPs) to hairpin loop structures called **iron response elements (IREs)** located in the 5' and 3' untranslated regions (UTRs) of the mRNAs coding for ferritin and TfR1, respectively (**Figure 52-7**). IRPs bind to the IREs only when intracellular iron levels are low. Binding at the 3' UTR of mRNA for TfR1 stabilizes it, thereby increasing TfR1 synthesis and expression on the cell surface. Alternatively, binding of an IRP to the IRE located at the 5' UTR of ferritin mRNA blocks translation. Similarly, when iron levels are high, the IRBs dissociate. Under these circumstances translation of ferritin mRNA is facilitated and TfR1 mRNA is rapidly degraded.

Hepcidin Is the Chief Regulator of Systemic Iron Homeostasis

The 25-amino acid peptide **hepcidin** plays a central role in iron homeostasis. Synthesized in the liver as an 84-amino acid precursor (prohepcidin), **hepcidin binds to the cellular**

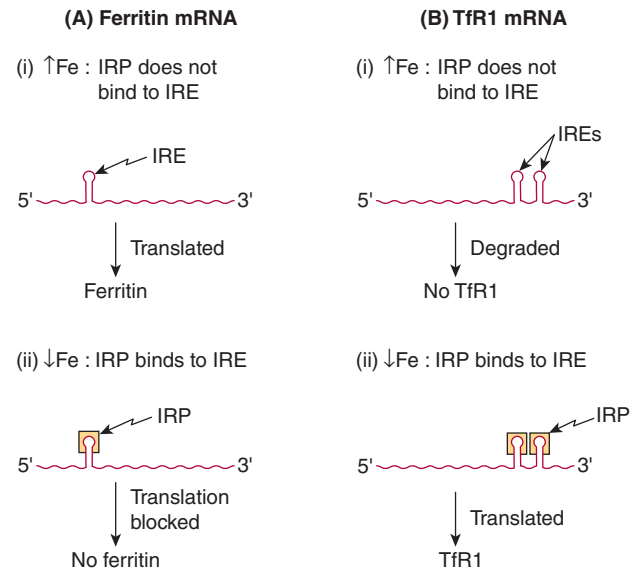

FIGURE 52-7 Schematic representation of the reciprocal relationship between synthesis of ferritin and the transferrin receptor (TfR1). The mRNA for ferritin is represented on the left, and that for TfR1 on the right of the diagram. At high concentrations of iron, the iron bound to the IRP prevents that protein from binding the IREs on either type of mRNA. The mRNA for ferritin is able to be translated under these circumstances, and ferritin is synthesized. On the other hand, when the IRP is not able to bind to the IRE on the mRNA for TfR1, that mRNA is degraded. In contrast, at low concentrations of iron, the IRP is able to bind to the IREs on both types of mRNA. In the case of the ferritin mRNA, this prevents it from being translated. Hence ferritin is not synthesized. In the case of the mRNA for TfR1, binding of the IRP prevents that mRNA from being degraded, it is translated, and TfR1 is synthesized. IRP, iron regulatory protein; IRE, iron response element.

iron exporter, ferroportin, triggering its internalization and degradation. The consequent decrease in ferroportin results in decreased iron absorption in the intestine (producing a “mucosal block”) and depressed iron recycling by macrophages (**Figure 52-8**). Together, these result in a reduction in circulating iron levels (hypoferremia) as well as reduced placental iron transfer during pregnancy. When plasma iron levels are high, hepatic synthesis of hepcidin increases, thus reducing iron absorption and macrophage iron recycling. The opposite occurs when plasma iron levels are low.

Hepcidin Expression Is Influenced by Iron, Erythropoiesis, Inflammation, and Hypoxia

Liver cells monitor iron levels using a multicomponent “iron-sensing complex” comprised of two transmembrane receptors whose cores consist of homodimers of TfR1 and TfR2, respectively. These two complexes are linked by a third transmembrane protein, **HFE protein**, which is commonly mutated in hereditary hemochromatosis (**Figure 52-9**). HFE protein is a major histocompatibility (MHC) class 1-like molecule that is expressed on the cell surface, where it is bound to β_2 -microglobulin (a component of class I MHC molecules,

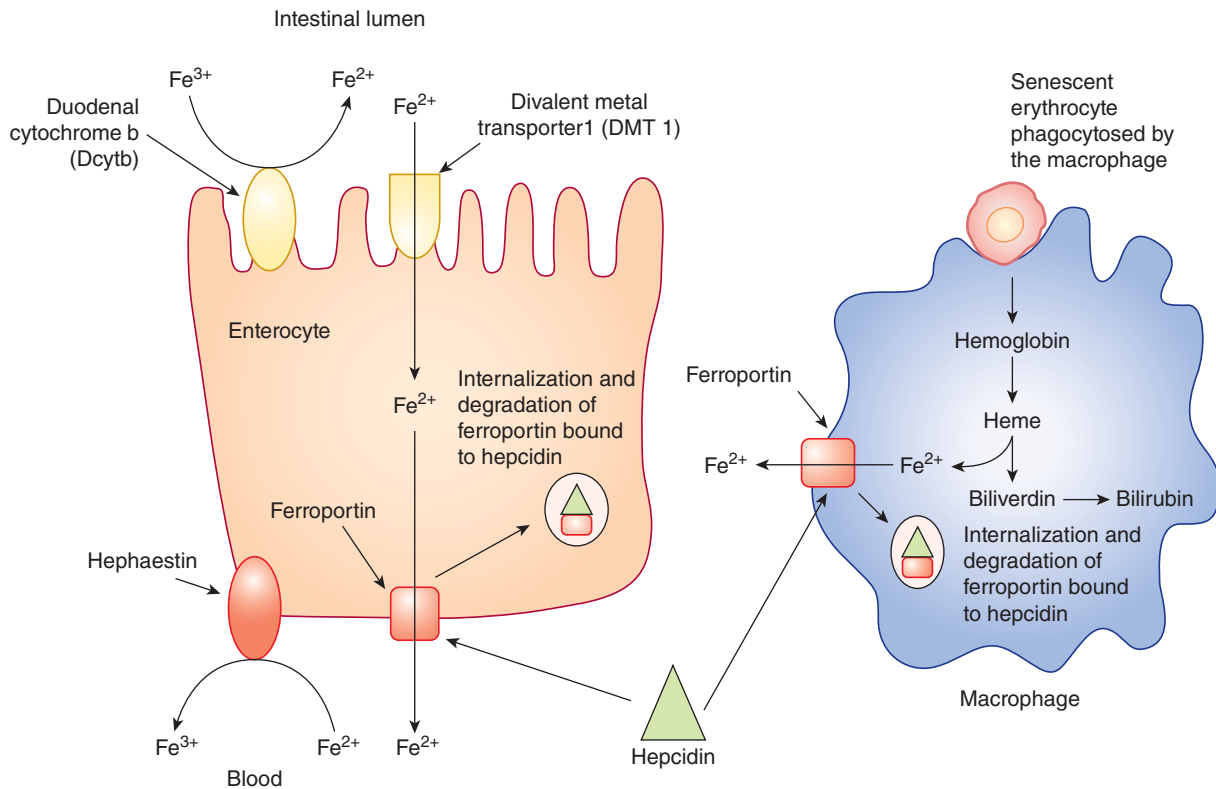

FIGURE 52-8 Role of hepcidin in systemic iron regulation. Hepcidin binds to and triggers the internalization and degradation of ferroportin expressed on the surface of enterocytes and macrophages. This decreases iron absorption from the intestine and inhibits iron release from macrophages, leading to hypoferrremia. (Based on Andrews NC: Forging a field: the golden age of iron biology. *Blood* 2008;112(2):219.)

not shown in Figure 52-9) and, normally, TfR1. TfR-1 also binds the iron-bound form of transferrin (Tf-Fe), and does so at a site that overlaps the site for HFE. When iron is abundant and Tf-Fe levels are high, HFE is displaced from TfR1. The displaced HFE protein then binds to TfR2, forming a complex that can be further stabilized by binding of Tf-Fe. Binding of HFE to TfR2 triggers an intracellular signaling cascade that activates expression of *HAMP*, the gene encoding hepcidin.

Bone Morphogenetic Proteins Influence Hepcidin Expression

While bone morphogenetic proteins (BMPs) act by mechanisms that are distinct from HFE protein, considerable cross-talk exists between these pathways. BMP binds to a cell-surface receptor (BMPR) whose binding affinity is augmented by binding to a co-receptor, **hemojuvelin** (HJV). The activation of the BMPR-HJV complex triggers the phosphorylation of intracellular signaling proteins called **SMADs**, which subsequently results in transcriptional activation of hepcidin (Figure 52-9).

Erythropoietic Signals Regulate Hepcidin Levels

The synthesis of hepcidin is depressed in persons suffering from β -thalassemia major, which is characterized by ineffective erythropoiesis and iron overload. Two molecules

secreted by erythroblasts, **growth differentiation factor 15 (GDF15)** and **twisted gastrulation 1 (TWSG1)**, also have been shown to inhibit expression of hepcidin in β -thalassemia.

Hepcidin synthesis is induced by cytokines such as **interleukin-6 (IL-6)** that are released as part of an inflammatory response. Binding of IL-6 to its cell surface receptor stimulates gene expression by activating the JAK-STAT (Janus Kinase—Signal Transducer and Activator of Transcription) pathway (Figure 52-9). Anemia that is associated with chronic inflammation (**anemia of inflammation or AI**) is probably due to inflammation-mediated upregulation of hepcidin. AI manifests as a microcytic, hypochromic anemia that is refractory to iron supplementation. **Hypoxia** suppresses hepcidin expression. This effect is mediated by erythropoietin, whose synthesis is controlled by hypoxia-inducible transcription factors 1 and 2 (HIF-1 and HIF-2).

IRON DEFICIENCY & ANEMIA ARE COMMON WORLDWIDE

Iron deficiency is extremely common in many parts of the world, especially in developing countries. Major causes of iron insufficiency include dietary deficiency, malabsorption, gastrointestinal bleeding, and episodic blood loss such as from menstruation. Persistent iron deficiency can lead to anemia.

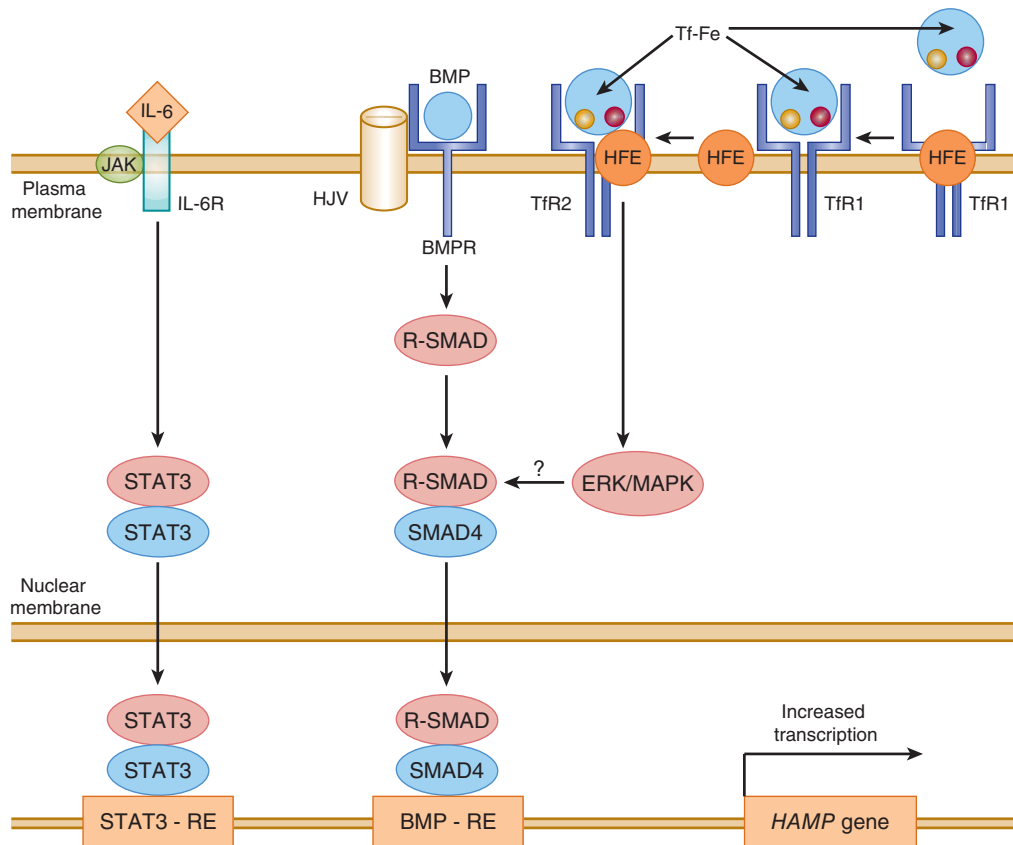

FIGURE 52-9 Regulation of hepcidin gene expression. Tf-Fe (holotransferrin) competes with HFE for binding to TFR1. High levels of Tf-Fe displace HFE from its binding site on TFR1. Displaced HFE binds to TFR2 along with Tf-Fe to signal via the ERK/MAPK pathway to induce hepcidin expression. BMP binds to its receptor BMPR and HJV (co-receptor) to activate R-SMAD. R-SMAD dimerizes with SMAD4, then translocates to the nucleus where it binds to the BMP-RE, resulting in transcriptional activation of hepcidin as shown. IL-6, which is a biomarker of inflammation, binds to its cell-surface receptor and activates the JAK-STAT pathway. STAT3 translocates to the nucleus where it binds to its response element (STAT-RE) on the hepcidin gene to induce it. BMP-RE, BMP response element; BMP, bone morphogenetic protein; BMPR, bone morphogenetic protein receptor; ERK-MAPK, extracellular signal-regulated kinase/mitogen-activated protein kinase; *HAMP*, gene encoding hepcidin antimicrobial peptide (hepcidin); HJV, hemojuvelin; IL-6, interleukin 6; IL-6R, interleukin 6 receptor; JAK, Janus-associated kinase; SMAD, Sma and MAD (Mothers Against Decapentaplegic)-related protein; STAT, signal transduction and activator of transcription; STAT3-RE, STAT 3 response element; Tfr1, transferrin receptor 1; Tfr2, transferrin receptor 2. (Redrawn from Hentz MW, Muckenthaler MU, Gali B, et al: Two to tango: regulation of mammalian iron metabolism. *Cell* 2010;142:24.)

The failure of intestinal iron absorption to meet the body's demands results in a **negative iron balance**. This leads to progressive depletion of the iron stores as they become mobilized to meet requirements. At this stage, all laboratory tests are normal, except for a low serum ferritin, a biomarker of body iron stores. If serum ferritin levels fall below 15 $\mu\text{g}/\text{dL}$, transferrin levels increase, producing a rise in the **total iron-binding capacity**. The level of **transferrin saturation**, however, will fall. Upon reaching 20% or below, hemoglobin synthesis will be impaired, resulting in **iron-deficient erythropoiesis**. If iron deficiency is not corrected hemoglobin levels in blood will gradually fall, resulting in **iron-deficiency anemia**. Patients typically present a **hypochromic, microcytic blood picture** that is accompanied by fatigue, pallor, and reduced exercise capacity.

The erythrocytes of persons suffering from iron deficiency anemia display increased levels of surface transferrin receptor-1 and deficits in the ferrochelatase-catalyzed incorporation of iron into protoporphyrin IX. The resulting rise in the levels of **soluble transferrin receptor protein (sTfR)** released into the plasma by partial proteolysis of cell surface transferrin receptors and the accumulation of **red-cell protoporphyrin** serve as diagnostic biomarkers for iron-deficiency anemia. Estimation of the serum sTfR level is especially useful for distinguishing anemia due to chronic inflammation, which does not affect the level of erythrocyte transferrin receptors, from iron deficiency anemia. **Table 52-5** summarizes the levels of these and other clinically utilized biomarkers typically observed as patients progress through each stage of iron deficiency anemia.

TABLE 52-5 Changes in Various Laboratory Tests Used to Assess Iron-Deficiency Anemia

Parameter	Normal	Negative Iron Balance	Iron-Deficient Erythropoiesis	Iron-Deficiency Anemia
Serum ferritin ($\mu\text{g/dL}$)	50-200	Decreased <20	Decreased <15	Decreased <15
Total iron binding capacity (TIBC) ($\mu\text{g/dL}$)	300-360	Slightly increased >360	Increased >380	Increased >400
Serum iron ($\mu\text{g/dL}$)	50-150	Normal	Decreased <50	Decreased <30
Transferrin saturation (%)	30-50	Normal	Decreased <20	Decreased <10
RBC protoporphyrin ($\mu\text{g/dL}$)	30-50	Normal	Increased	Increased
Soluble transferrin receptor ($\mu\text{g/L}$)	4-9	Increased	Increased	Increased
RBC morphology	Normal	Normal	Normal	Microcytic Hypochromic

Modified, with permission, from Figure 98-2, page 630, *Harrison's Principles of Internal Medicine*, 17th ed. Fauci AS, et al (editors). McGraw-Hill, 2008.

Hereditary Hemochromatosis Is Characterized by Iron Overload

The presence of stainable iron in tissues, **hemosiderosis**, is characteristic of individuals suffering from **hemochromatosis** or iron overload. The hereditary forms of hemochromatosis are caused by mutations in the *HFE* gene or, less frequently, the genes encoding hepcidin, *TfR2*, *HJV*, or ferroportin that lead to the hyperabsorption of iron by the intestines (Table 52-6). **Secondary iron overload** is usually associated with ineffective erythropoiesis, as seen in the thalassemia syndromes. Repeated blood transfusions can also result in progressive iron overload. In either case, the accumulation of iron in liver, heart, and pancreas can lead to the generation of toxic levels of reactive oxygen species.

SERUM INHIBITORS PREVENT INDISCRIMINATE PROTEOLYSIS

Proteases are essential participants in tissue remodeling, blood clotting, elimination of old or diseased cells, destruction of invading pathogens, and other physiologic functions. Left

unchecked, however, proteolytic enzymes that are secreted or escape into the blood can damage healthy tissue. Protection from indiscriminate proteolysis involves a battery of serum proteins that inhibit, and thereby limit the scope protease action.

Genetic Deficiency of α_1 -Antiproteinase (α_1 -Antitrypsin) Is Associated With Emphysema & One Type of Liver Disease

α_1 -**Antiproteinase**, a 394 residue glycoprotein that makes up >90% of the α_1 fraction of plasma proteins, is the principal **serine protease inhibitor (serpin)** or **Pi** in human blood. Formerly called α_1 -antitrypsin, α_1 -antiproteinase inhibits trypsin, elastase, and other serine proteases by associating with them and forming an inactive covalent complex. At least 75 **polymorphic forms** occur. The major genotype is MM, and its phenotypic product is PiM. α_1 -Antiproteinase is synthesized by hepatocytes and macrophages. A deficiency of this serpin plays a role in certain cases (approximately 5%) of emphysema, particularly in subjects with the **ZZ genotype** (who synthesize PiZ) and in PiSZ heterozygotes, both of whom secrete considerably less protein than PiMM individuals.

TABLE 52-6 Iron Overload Conditions

Hereditary Hemochromatosis
• HFE-related hemochromatosis (type 1)
• Non-HFE-related hemochromatosis
↳ Juvenile hemochromatosis (type 2)
▪ Hepcidin mutation (type 2A)
▪ Hemojuvelin mutation (type 2B)
↳ Transferrin receptor 2 mutation (type 3)
↳ Ferroportin mutation (type 4)
Secondary Hemochromatosis
• Anemia characterized by ineffective erythropoiesis (eg, thalassemia major)
• Repeated blood transfusions
• Parenteral iron therapy
• Dietary iron overload (Bantu siderosis)
Miscellaneous Conditions Associated with Iron Overload
• Alcoholic liver disease
• Nonalcoholic steatohepatitis
• Hepatitis C infection

Oxidation of Met₃₅₈ Inactivates α_1 -Antiproteinase

The smoke produced by burning tobacco products and many industrial activities contain components that react in the lungs with α_1 -antiproteinase, oxidizing a key **methionine** residue located in its protease binding domain, Met₃₅₈. The oxidized α_1 -antiproteinase can no longer bind to and neutralize serine proteases. The damage produced by the unchecked proteolytic activity of elastase and other serine proteases on lung tissue can contribute to the development of emphysema. Smoking can be particularly devastating for patients (eg, PiZZ phenotype) who already have low levels of α_1 -antiproteinase. Intravenous administration of serpins (augmentation therapy) has been used as an adjunct in the treatment of patients with emphysema that exhibit α_1 -antiproteinase deficiency. The further diminution in α_1 -antitrypsin brought about by smoking results in increased proteolytic destruction of lung tissue, accelerating the development of emphysema. Individuals deficient in α_1 -antiproteinase

are also at greater risk of lung damage under conditions, such as pneumonia, that induce the accumulation of polymorphonuclear white blood cells in the lung.

Deficiency of α_1 -antiproteinase is also implicated in **α_1 -antitrypsin deficiency liver disease**, which afflicts persons possessing the ZZ phenotype. α_1 -Antiproteinase accumulates in hepatocytes of affected individuals, forming polymeric aggregates in the cisternae of the endoplasmic reticulum. The propensity to form aggregates has been traced to the substitution of Glu₃₄₂ of α_1 -antiproteinase by **lysine** in ZZ individuals. **Hepatitis** results with consequent **cirrhosis**.

α_2 -Macroglobulin Neutralizes Many Proteases & Targets Certain Cytokines to Tissues

α_2 -Macroglobulin, a member of the **thiol ester plasma protein family**, comprises 8% to 10% of the total plasma protein in humans. This homotetrameric glycoprotein is the most abundant member of a group of plasma proteins that include complement proteins C3 and C4. α_2 -Macroglobulin is synthesized by monocytes, hepatocytes, and astrocytes. It mediates the inhibition and clearance of a broad spectrum of truant proteases by a “Venus fly trap” mechanism. The key components of the trap include a 35 residue “bait domain” located near the middle of its polypeptide sequence and an internal cyclic thiol ester linking a cysteine and a glutamine residue (**Figure 52–10**). Cleavage of the bait domain triggers a massive conformational change in α_2 -macroglobulin, causing the envelopment of the attacking protease. The reactive thioester reacts with the protease to form a covalent bond between the proteins. This conformational change also exposes a sequence in α_2 -macroglobulin that is recognized by cell surface receptors located on a variety of cell types, which leads to the receptor-mediated clearance of the complex from the plasma.

In addition to serving as the plasma’s predominant broad spectrum, or **panprotease**, inhibitor, α_2 -macroglobulin also binds to and transports approximately 10% of the **zinc** in plasma (the remainder being transported by albumin) as well as **cytokines** such as platelet-derived growth factor and transforming growth factor- β . As a cytokine transporter, α_2 -macroglobulin appears to be involved in targeting these effectors toward particular tissues or cells. Once taken up by

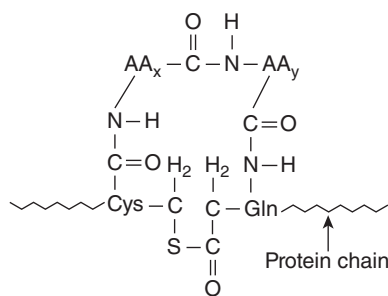

FIGURE 52–10 An internal cyclic thiol ester bond, as present in α_2 -macroglobulin. AA_x and AA_y are neighboring amino acids to cysteine and glutamine.

TABLE 52–7 A Classification of Amyloidosis

Type	Protein Implicated
Primary	Principally light chains of immunoglobulins
Secondary	Serum amyloid A (SAA)
Familial	Transthyretin; also rarely apolipoprotein A-1, cystatin C, fibrinogen, gelsolin, lysozyme
Alzheimer's disease	Amyloid β peptide (see Chapter 57, case no. 2)
Dialysis-related	β_2 -microglobulin

Note: Proteins other than these listed have also been implicated in amyloidosis.

cells, the cytokines dissociate, freeing them to modulate their growth and function.

DEPOSITION OF PLASMA PROTEINS IN TISSUES LEADS TO AMYLOIDOSIS

Amyloidosis refers to an impairment of tissue function that results from the accumulation of insoluble aggregates of proteins between cells. The term is a misnomer, as it was originally thought that the insoluble fibrils were starch-like in nature. The fibrils generally are made up of proteolytic fragments of plasma proteins whose conformation is rich in **β -pleated sheet**. The fibrils generally also contain a **P component**, which is derived from **serum amyloid P component**, a plasma protein closely related to C-reactive protein.

Structural abnormalities or overproduction of at least 20 different proteins have been implicated in various types of amyloidosis. **Primary** amyloidosis (**Table 52–7**) typically is caused by a monoclonal plasma cell disorder leading to the accumulation of fragments generated from the **light chains** (see below) of an immunoglobulin. **Secondary** amyloidosis results from an accumulation of fragments of **serum amyloid A (SAA)** consequent to chronic infections or cancer. Under these conditions, elevated levels of inflammatory cytokines stimulate the liver to increase the synthesis of SAA, which leads to a concomitant rise in proteolytic degradation products derived from serum amyloid A. **Familial amyloidosis** results from accumulation of mutated forms of certain plasma proteins, particularly **transthyretin** (**Table 52–3**). Over 80 mutationally altered forms of this protein have been documented. In patients undergoing long-term chronic dialysis, the plasma protein **β_2 -microglobulin**, which is retained in the plasma by dialysis membranes can accumulate.

PLASMA IMMUNOGLOBULINS PLAY A MAJOR ROLE IN THE BODY'S DEFENSE MECHANISMS

The three major components of the body’s immune system are: **B lymphocytes (B cells)**, **T lymphocytes (T cells)**, and **the innate immune system**. B lymphocytes are mainly derived

from bone marrow cells, while T lymphocytes originate from the thymus. The **B cells** are responsible for the synthesis of circulating, humoral antibodies, also known as **immunoglobulins**. The **T cells** are involved in a variety of important **cell-mediated immunologic processes** such as graft rejection, hypersensitivity reactions, and defense against malignant cells and many viruses. B and T cells respond in an **adaptive** manner, developing a targeted response for each invader encountered. The **innate immune system** defends against infection in a nonspecific manner. It contains a variety of cells such as phagocytes, neutrophils, natural killer cells, and others that will be discussed in Chapter 54.

Immunoglobulins Are Comprised of Multiple Polypeptide Chains

Immunoglobulins (Ig) are oligomeric proteins whose individual subunits traditionally have been classified as heavy (H) or light (L) based on their migration during SDS-polyacrylamide gel electrophoresis. Human immunoglobulins can be grouped into five classes abbreviated as IgA, IgD, IgE, IgG, and IgM (Table 52–8). The biologic functions of each class are summarized in Table 52–9. The most abundant of the five, IgG, consist of two identical light chains (23 kDa) and two identical heavy chains (53–75 kDa) linked together by a network of disulfide bonds. The L chains and H chains are synthesized as separate polypeptides that are subsequently assembled within the B cell or plasma cell into mature immunoglobulin molecules, all of which are **glycoproteins**.

The Y-shaped configuration of the immunoglobulin core unit is illustrated by the IgG heterotetramer (L_2H_2) shown in Figure 52–11. Some immunoglobulins such as immune IgG

exist only in the basic tetrameric structure. Others such as IgA and IgM can form higher oligomers comprised of two, three (IgA), or five (IgM) copies of the core tetrameric unit (Figure 52–12). The type of H chain determines the class of immunoglobulin and thus its effector function (see below): α (IgA), δ (IgD), ϵ (IgE), γ (IgG), and μ (IgM). The γ chains of IgG are organized into four conserved domains: an amino terminal variable region (V_H) and three **constant regions** (C_{H1} , C_{H2} , C_{H3}). The five types of H chains are distinguished by differences in their C_H regions. The μ and ϵ chains each have four C_H domains rather than the usual three.

The IgG light chain can be divided into a C-terminal **constant region** (C_L) and amino terminal **variable region** (V_L). There are two general types of light chains, **kappa** (κ) and **lambda** (λ), which can be distinguished on the basis of structural differences in their C_L regions. A given immunoglobulin molecule always contains two κ or two λ light chains—never a mixture of κ and λ . In humans, the κ chains are more common than λ chains in immunoglobulin molecules.

IgG molecules are **divalent**. The tip of each Y contains an antigen-binding site made up of V_H and V_L domains arranged together to form two sheets of antiparallel amino acids. The site on the antigen to which an antibody binds is termed an **antigenic determinant**, or **epitope**. The region between the C_{H1} and C_{H2} domains, which can be readily cleaved using the pepsin or papain (Figure 52–11), is referred to as the **“hinge region.”** The hinge region confers **flexibility** and allows both Fab arms to move independently. This facilitates binding to antigenic sites that may be variable distances apart or that are present on two different bacteria or viruses. In this way, antibody-antigen clusters can be formed whose size renders them more easily recognized and disposed of by phagocytic

TABLE 52–8 Properties of Human Immunoglobulins

Property	IgG	IgA	IgM	IgD	IgE
Percentage of total immunoglobulin in serum (approximate)	75	15	9	0.2	0.004
Serum concentration (mg/dL) (approximate)	1000	200	120	3	0.05
Sedimentation coefficient	7S	7S or 11S ^a	19S	7S	8S
Molecular weight (×1000)	150	170 or 400 ^a	900	180	190
Structure	Monomer	Monomer or dimer	Monomer or pentamer	Monomer	Monomer
H-chain symbol	γ	α	μ	δ	ϵ
Complement fixation	+	—	+	—	—
Transplacental passage	+	—	—	?	—
Mediation of allergic responses	—	—	—	—	+
Found in secretions	—	+	—	—	—
Opsonization	+	—	— ^b	—	—
Antigen receptor on B cell	—	—	+	?	—
Polymeric form contains J chain	—	+	+	—	—

^aThe 11S form is found in secretions (eg, saliva, milk, and tears) and fluids of the respiratory, intestinal, and genital tracts.

^bIgM opsonizes indirectly by activating complement. This produces C3b, which is an opsonin.

Source: Reproduced, with permission, from Levinson W, Jawetz E: *Medical Microbiology and Immunology*, 7th ed. McGraw-Hill, 2002.

TABLE 52-9 Major Functions of Immunoglobulins

Immunoglobulin	Major Functions
IgG	Main antibody in the secondary response. Opsonizes bacteria, making them easier to phagocytose. Fixes complement, which enhances bacterial killing. Neutralizes bacterial toxins and viruses. Crosses the placenta.
IgA	Secretory IgA prevents attachment of bacteria and viruses to mucous membranes. Does not fix complement.
IgM	Produced in the primary response to an antigen. Fixes complement. Does not cross the placenta. Antigen receptor on the surface of B cells.
IgD	Found on the surfaces of B cells where it acts as a receptor for antigen.
IgE	Mediates immediate hypersensitivity by causing release of mediators from mast cells and basophils upon exposure to antigen (allergen). Defends against worm infections by causing release of enzymes from eosinophils. Does not fix complement. Main host defense against helminthic infections.

Source: Reproduced, with permission, from Levinson W, Jawetz E: *Medical Microbiology and Immunology*, 7th ed. McGraw-Hill, 2002.

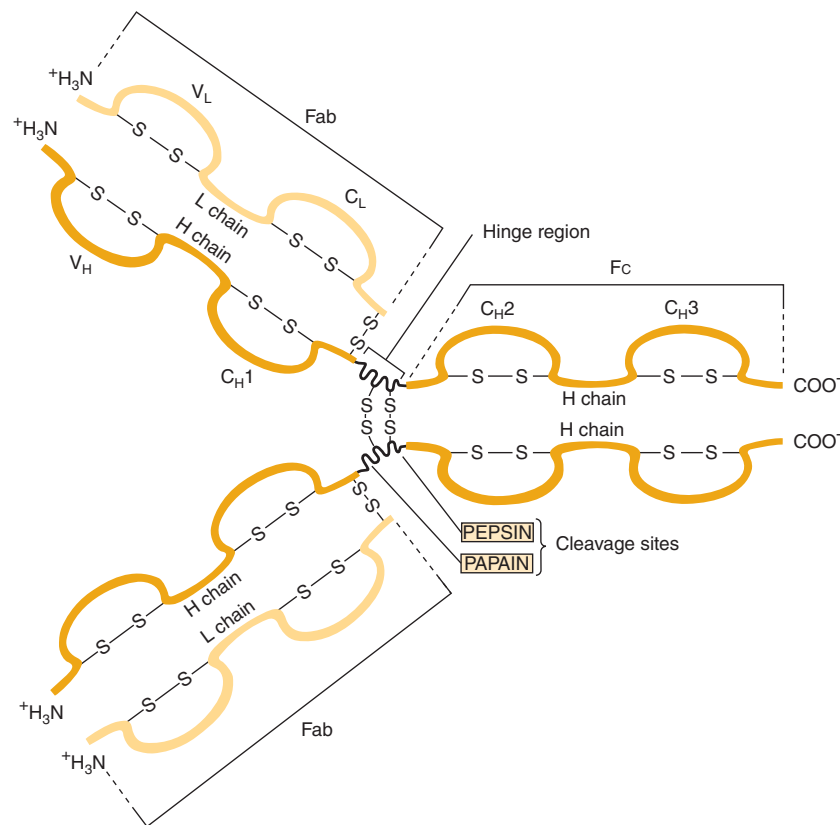

FIGURE 52-11 Structure of IgG. The molecule consists of two light (L) chains and two heavy (H) chains. Each light chain consists of a variable (V_L) and a constant (C_L) region. Each heavy chain consists of a variable region (V_H) and a constant region that is divided into three domains (C_{H1}, C_{H2}, and C_{H3}). The C_{H2} domain contains the complement-binding site and the C_{H3} domain contains a site that attaches to receptors on neutrophils and macrophages. The antigen-binding site is formed by the hypervariable regions of both the light and heavy chains, which are located in the variable regions of these chains (see Figure 50-10). The light and heavy chains are linked by disulfide bonds, and the heavy chains are also linked to each other by disulfide bonds. (Reproduced, with permission, from Parslow TG, et al (editors): *Medical Immunology*, 10th ed. McGraw-Hill, 2001.)

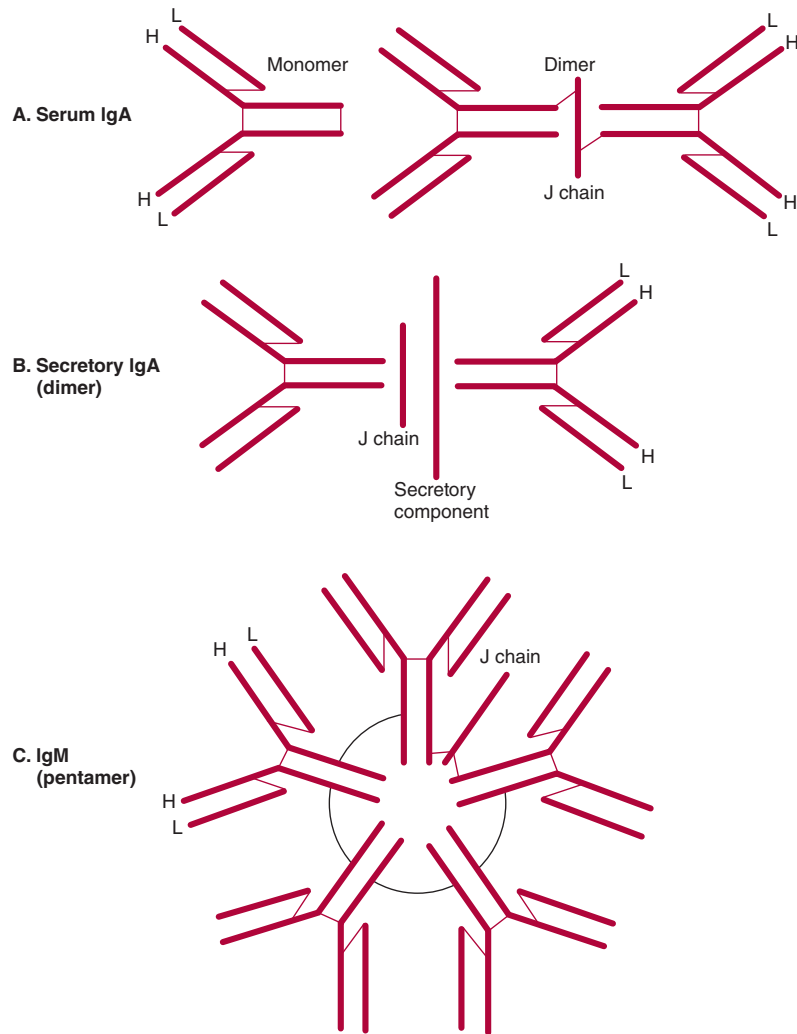

FIGURE 52-12 Schematic representation of serum IgA, secretory IgA, and IgM. Both IgA and IgM have a J chain, but only secretory IgA has a secretory component. Polypeptide chains are represented by thick lines; disulfide bonds linking different polypeptide chains are represented by thin lines. (Reproduced, with permission, from Parslow TG, et al (editors): *Medical Immunology*, 10th ed. McGraw-Hill, 2001.)

leukocytes. This phenomenon is commonly demonstrated in the laboratory by the formation of erythrocyte **rosettes**.

Variable Regions Confer Binding Specificity

The **variable regions** of the immunoglobulin light and heavy chains form the **antigen-binding sites** that dictate the amazing specificity of antibodies. As their name implies, they are quite heterogeneous. In fact, no two variable regions from different humans share identical amino acid sequences. The variable regions of the L and H chains consist of a handful of short (5-10 residue) islands called **hypervariable regions** interspersed within a polypeptide “sea” by relatively invariable **framework regions** (Figure 52-13). Hypervariable regions are also termed **complementarity-determining regions (CDRs)**. An **antigen-binding site** is formed when the **hypervariable regions** of the H and L chains align together

in three-dimensional space (tertiary structure) as projecting loops from the antibody surface.

Various combinations of H and L chain CDRs can give rise to multiple antibodies possessing different specificities, a feature termed **combinatorial diversity**. Large antigens interact with all of the CDRs of an antibody, whereas small ligands may interact with only one or a few CDRs that form a pocket or groove in the antibody molecule. The essence of antigen-antibody interactions is **mutual complementarity** between the surfaces of CDRs and epitopes that involve multiple **noncovalent** interactions such as hydrogen bonding, salt bridges, hydrophobic interactions, and van der Waal’s forces (see Chapter 2).

The Constant Regions Determine Class-Specific Effector Functions

The **constant regions** of the immunoglobulin molecules, particularly the C_{H2} and C_{H3} (and C_{H4} of IgM and IgE) located

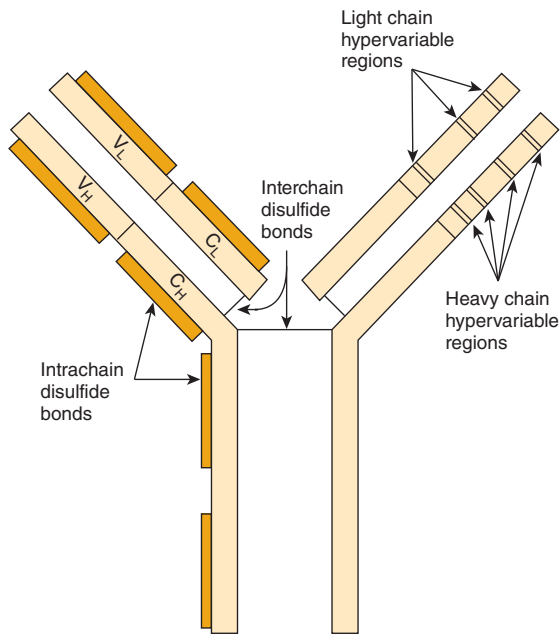

FIGURE 52–13 Schematic model of an IgG molecule showing approximate positions of the hypervariable regions in heavy and light chains. The antigen-binding site is formed by these hypervariable regions. The hypervariable regions are also called complementarity-determining regions (CDRs). (Modified and reproduced, with permission, from Parslow TG, et al (editors): *Medical Immunology*, 10th ed. McGraw-Hill, 2001.)

within the Fc fragment, are responsible for the **class-specific effector functions** of the different immunoglobulin molecules (Table 52–9, bottom part), such as complement fixation or transplacental passage.

Antibody Diversity Depends on Gene Rearrangements

The human genome contains less than 150 immunoglobulin genes. Nevertheless, each person is capable of synthesizing perhaps 1 million different antibodies, each specific for a unique antigen. Clearly, immunoglobulin expression does not follow the “one gene, one protein” paradigm. Instead, immunoglobulin diversity is generated by **combinatorial mechanisms** based upon mixing and rearranging a finite pool of genetic information in multiple ways (see Chapters 35 and 38).

The first source of antibody diversity is the division of the coding sequence for each immunoglobulin chain among multiple genes. Each light chain is the product of at least three separate structural genes that code for the **variable region** (V_L), **joining region** (J) (bearing no relationship to the J chain of IgA or IgM), and **constant region** (C_L), respectively. Similarly, each heavy chain is the product of at least **four** different genes that code for a **variable region** (V_H) gene, a **diversity region** (D), a **joining region** (J), and a **constant region** (C_H) gene. Each gene is present in the human genome in several versions offering the potential for the assembly of a multiplicity of combinations.

Diversity is further augmented through the action of the **activation-induced cytidine deaminase** (AID). By catalyzing the conversion of cytidine to uracil, AID massively increases the frequency of mutation of immunoglobulin V genes. These mutations are **somatic** in nature, ie, unique to a differentiated cell rather than to a germline cell. Consequently, each activation of AID generates new subpopulations of B cells that harbor unique mutations of their V genes, causing each to synthesize immunoglobulins of differing antigen specificity. In some pathologic states, the mutagenic action of AID can lead to the generation of **autoantibodies** that target the body’s endogenous components, a phenomenon termed **autoimmunity**.

A third mechanism for generating antibodies targeting novel antigens is **junctional diversity**. This refers to the addition or deletion of random numbers of nucleotides that takes place when certain gene segments are joined together. As is the case with AID, the mutations generated by junctional diversity are somatic in nature.

Class (Isotype) Switching Occurs During Immune Responses

In most humoral immune responses, antibodies of different classes are generated that possess identical antigen specificities. Each class appears in a specific chronologic order in response to the immunogen (immunizing antigen). For instance, antibodies of the IgM class normally precede molecules of the IgG class. The transition from the synthesis of one class to another is designated **class** or **isotype switching**. Switching involves the combining of a given immunoglobulin light chain with different heavy chains. Whereas a newly synthesized light chain will initially be mated with a μ chain to generate a specific IgM molecule, over time the same antigen-specific light chain will be mated with a γ chain. This γ chain will, however, possess an identical V_H region to that of the μ chain, thus generating an IgG whose antigen specificity is identical to that of the original IgM molecule. The same light chain can also combine with an α heavy chain, again containing the identical V_H region, to form an IgA molecule with identical antigen specificity. Immunoglobulin molecules of different classes that possess identical variable domains and antigen specificity are said to share an **idiotype**. (Idiotypes are the antigenic determinants formed by the specific amino acids in the hypervariable regions.)

Monoclonal Antibodies Are an Important Research Tool

Antibodies have emerged as a major tool in biomedical research, diagnosis, and treatment. Originally, the production of antibodies against a selected antigen required that the antigen be injected into a host animal, such as a rabbit or goat, and serum containing plasma immunoglobulins that included (hopefully) antibodies against the antigen of interest obtained. When an antigen is injected into an animal, the resulting antibodies are produced by a mixture of B cells that synthesize antibodies directed against different sites (epitopes or determinants)

on the antigen. Antibodies produced in animal hosts are thus heterogeneous or **polyclonal** in nature. Moreover, unless subjected to costly affinity purification, serum immunoglobulins also contain antibodies against many thousands of antigens to which the host animal has been exposed during its lifetime.

Homogenous **monoclonal** antibodies targeting a single epitope, and that are free from other contaminating immunoglobulins, can be generated in the laboratory. Typically, B cells are obtained from the spleen of a mouse (or other suitable animal) previously injected with an antigen or mixture of antigens (eg, foreign cells). The B cells are mixed with mouse **myeloma cells** and exposed to polyethylene glycol, which causes cell fusion. The product of this fusion is a permanent cell line called a **hybridoma** capable of providing a continuous supply of monoclonal antibodies. **Figure 52–14** summarizes the principles involved in generating hybridoma cells. By plating highly diluted cell mixtures on a selective, hypoxanthine-aminopterin-thymidine (HAT)-containing medium, homogenous, **clonal** hybridoma lines originating from a single cell can be isolated. By identifying lines that secrete a monoclonal antibody specific for the antigen of choice, it is possible to obtain a battery of monoclonal antibodies specific for individual components of the immunogenic mixture or different epitopes on a single antigen. The hybridoma cells can be frozen and stored and subsequently thawed when more of the antibody is required; this ensures its long-term supply.

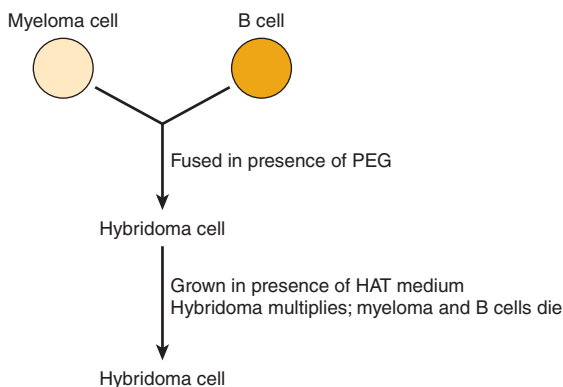

FIGURE 52–14 Scheme of production of a hybridoma cell.

The myeloma cells are immortalized, do not produce antibody, and are HGPRT⁻ (rendering the salvage pathway of purine synthesis [see Chapter 33] inactive). The B cells are not immortalized, each produces a specific antibody, and they are HGPRT⁺. Polyethylene glycol (PEG) stimulates cell fusion. The resulting hybridoma cells are immortalized (via the parental myeloma cells), produce antibody, and are HGPRT⁺ (both latter properties gained from the parental B cells). Any remaining B cells will die because they are not immortalized. In the presence of HAT, the myeloma cells will also die since the aminopterin in HAT suppresses purine synthesis via the *de novo* pathway by inhibiting reutilization of tetrahydrofolate (see Chapter 33). However, the hybridoma cells will survive, grow (because they are HGPRT⁺), and—if cloned—produce monoclonal antibody. (HAT, hypoxanthine, aminopterin, and thymidine; HGPRT, hypoxanthineguanine phosphoribosyl transferase.)

For **therapeutic use in humans**, monoclonal antibodies produced by murine cell lines can be **humanized**. This is accomplished by attaching the CDRs (the sites that bind antigens) onto appropriate sites in a human immunoglobulin molecule. This produces an antibody that is very similar to a human antibody whose reduced **immunogenicity** markedly diminishes the chances of an anaphylactic reaction.

FURTHER PROTECTION AGAINST INFECTION IS CONFERRED BY THE COMPLEMENT SYSTEM

Immunoglobulins form the core of the body's **adaptive immune system**, a name that reflects its ability to generate antibodies with new antigen binding specificities upon encountering a novel infectious agent. By contrast, the number, function, and specificity of the components that comprise the **innate immune system** are fixed and remain constant throughout life. The plasma-borne arm of the innate immune system is called the **complement system**, a name derived from the observation that it can be activated by antibody-antigen complexes, and therefore acts consequent to and in support of the immunoglobulins of the adaptive immune system.

The complement system displays features reminiscent of the blood's coagulation cascade. Both consist of sets of circulating zymogens (proproteins) that remain catalytically dormant until activated by proteolytic cleavage. These proteins, called **complement factors**, are synthesized by a variety of cell types, including hepatocytes, macrophages, monocytes, and intestinal endothelial cells. As is the case for clotting factors, most complement factors are propeptases (see Chapter 9) that, upon activation, target other components of the system, thereby generating a series or **cascade** of proteolytic activation events that amplify the production of the system's protective end products.

The **classical pathway** for activating the complex system is triggered when an antibody-antigen complex binds to and stimulates the protease activity of factor **C1**. C1 then cleaves complement factor C2 to form two smaller proteins, C2a and C2b, and cleaves complement factor C4 to form C4a and C4b (**Figure 52–15**). Two of the proteolytic fragments, C2a and C4b then associate to form a protease, the C3 convertase, which cleaves complement factor C3 into C3a and C3b. C3a now binds with the C2a:C4b heterodimer to form a heterotrimeric complex, the C5 convertase, that cleaves complement factor C5 into C5a and C5b. The C5b protein then combines with complement factors C6, C7, C8, and C9 to form the **membrane attack complex (MAC)**. MAC kills bacterial invaders by binding to and opening a pore in their plasma membrane. Following lysis, the bacterial remains are destroyed by phagocytic macrophages. Meanwhile, the C3a and C5a proteins serve as chemoattractants that recruit leukocytes to the site of infection and stimulate an inflammatory response.

Targeting of the MAC to invading bacteria is facilitated by the presence of thioester bonds in C3 and C4. Like the thioester

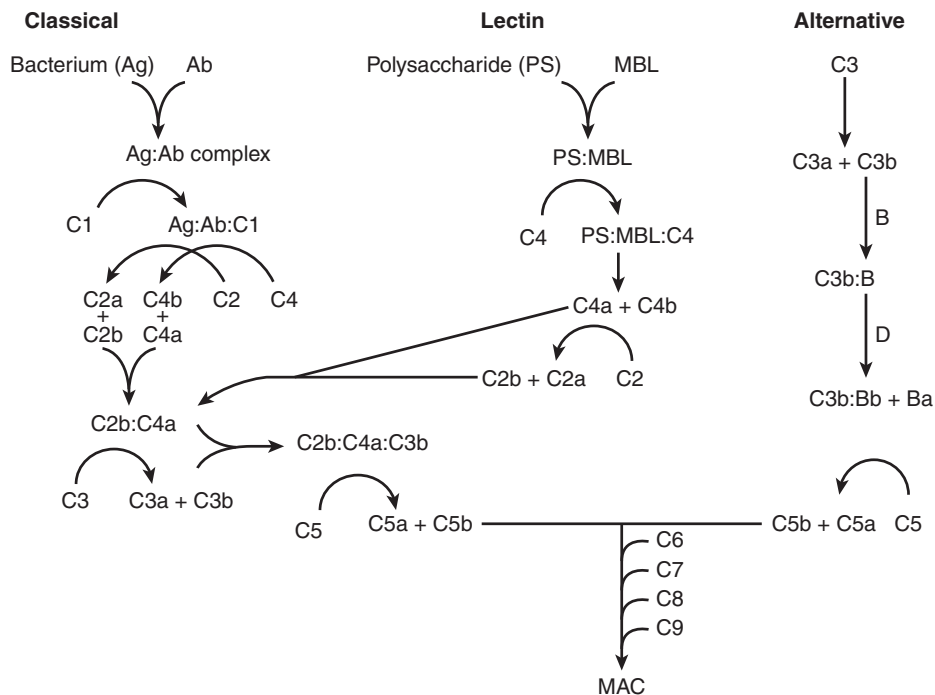

FIGURE 52-15 The complement cascade. Activation of the complement system can occur via three different mechanisms, referred to as the classical, lectin, and alternative pathways. Shown are the major components involved in each pathway, the products formed by proteolytic cleavage of the inactive proproteins, and the major complexes formed. Colons are used to indicate association in a complex.

bond in the plasma protease inhibitor α_2 -macroglobulin, this highly reactive bond becomes exposed as a result of the conformational change that accompanies activation. In the case of C3 and C4, the thioester reacts with the hydroxyl groups of the bacteria's surface polysaccharides, covalently anchoring them and the C5 convertase complexes of which they are a part to their target pathogen. Consequently, the components of the MAC are formed and assemble together in close proximity to the bacterial membrane.

Activation can also be triggered via the **lectin pathway**, wherein the complexes formed when a complement factor known as **mannose-binding lectin (MBL)**, also known as **mannan-binding protein (MBP)**, binds bacterial polysaccharides to generate a complex that recruits and activates C4 (Figure 52-15). The term **lectin** refers to any protein that binds polysaccharides. Most lectins are highly selective. MBL is specific for the mannose-containing carbohydrate moieties (**mannans**) of glycoproteins and **lipopolysaccharides** present on the surface of Gram-positive bacteria, some viruses, and several fungi. Upon binding to the polysaccharide-MBL complex, C4 undergoes autoproteolysis, forming C4a and C4b. In addition, it cleaves C2 into C2a and C2b. The activation cascade then proceeds as described for the classical pathway.

MBL circulates as large, 400 to 700 kDa, multivalent complexes consisting of four or more copies of a homotrimeric core unit made up of three copies of a ≈ 30 kDa polypeptide. Each polypeptide contains two major domains, an

amino-terminal collagen-like domain and a carboxyl-terminal carbohydrate-binding domain. The core of the homotrimer is formed when three collagen-like domains intertwine to generate an extended tail that leads to a globular head consisting of the three carbohydrate-binding domains. The homotrimers associate via their amino terminal tail regions into a disulfide-linked "stalk" from which the individual carbohydrate binding heads extend in a branched arrangement resembling that of the immunoglobulins (Figure 52-16).

The complement system also can be activated by the **alternative pathway**, which involves the activation of C3 by chemical hydrolysis, a process sometimes referred to as "ticking over." In the alternative pathway, C3b binds complement factor B, forming a C3b:B complex that is then cleaved by complex factor D. The resulting C3b:Bb complex possesses C5 convertase activity.

DYSFUNCTIONS OF THE IMMUNE SYSTEM CONTRIBUTE TO MANY PATHOLOGIC CONDITIONS

Dysfunctions of the innate and adaptive immune systems can have serious physiological consequences. Deficits in the production of immunoglobulins or complement factors can leave the affected individual extremely susceptible to occurrence and spread of bacterial, fungal, or viral infections.

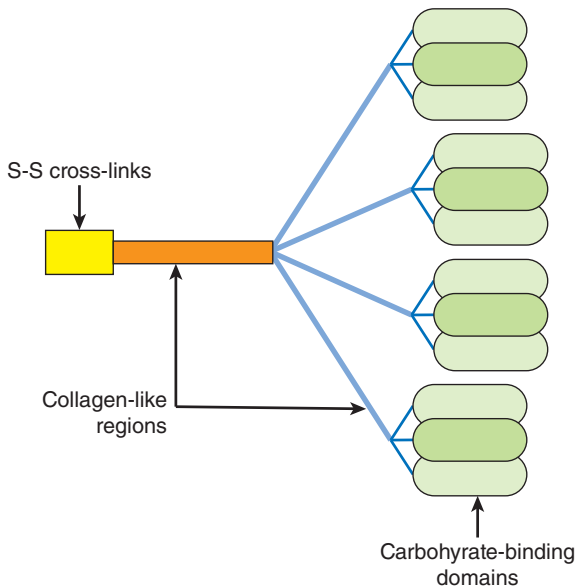

FIGURE 52-16 Schematic representation of mannose-binding lectin. Shown is a schematic diagram of a mannose-binding lectin (MBL) comprised of four sets of MBL homotrimers. The carbohydrate binding domains are colored green. The intertwined collagen-like binding domains for each trimer are shown in blue. The stalk region, where the amino terminal portions of the homotrimers of collagen-like domains associate together, is colored orange and yellow, with yellow marking the region where the S—S crosslinks that stabilize the tetramer of homotrimers are located.

Such persons are said to be in an **immunocompromised** state. Many factors can contribute to a depression in the effectiveness of the immune system. These include genetic abnormalities (eg **agammaglobulinemia**, in which production of IgG is markedly affected), exposure to toxins, viral infections, malnutrition, neoplastic transformation, or treatment with immunosuppressant drugs.

Overproduction and precocious activation of the immune and complement systems can also be deleterious. The failure of the immune system to differentiate host cells from a foreign invader can trigger an **autoimmune response** in which the body's immune system attacks its own tissues and organs. The resulting damage may be cumulative, such as occurs in rheumatoid arthritis and multiple sclerosis, or acute, such as the complete destruction of pancreatic islet cells that occurs in type 1 diabetes. In North America, the incidence of autoimmune disorders is three in every hundred persons.

Table 52-1 lists several of the more commonly encountered autoimmune disorders.

SUMMARY

- Plasma contains many proteins with a variety of functions. Most are synthesized in the liver. The majority are glycosylated.
- Albumin accounts for roughly 60%, by mass, of the protein content of plasma. As such, it is the principal determinant of intravascular osmotic pressure. Albumin also binds to and transports fatty acids, bilirubin, metal ions, and certain drugs.

- Haptoglobin binds extracorporeal hemoglobin and prevents its loss into the kidney and urine, which preserves iron for reutilization and prevents the formation of damaging precipitates in the tubules.
- Ferritin binds to and stores ferric iron inside cells.
- Transferrin transports iron to the sites where it is required.
- Ceruloplasmin, the major copper containing protein in plasma, is a ferroxidase that plays a key role in recycling the iron released when senescent red blood cells are destroyed.
- Hepcidin regulates iron homeostasis by blocking internalization of the cellular iron export protein, ferroportin.
- Hepcidin expression is stimulated when binding of transferrin-iron complexes to type-1 transferrin receptors displaces HFE protein, which then binds to and activates type-2 transferrin receptors.
- Hereditary hemochromatosis is a genetic disease involving excessive absorption of iron.
- α_1 -Antitrypsin is the major serine protease inhibitor of plasma. Genetic deficiency of this protein can lead to emphysema and liver disease.
- α_2 -Macroglobulin is a major plasma protein that neutralizes many proteases and targets certain cytokines to specific organs.
- Our bodies can synthesize immunoglobulins specific for as many as a million different targets, called antigens.
- The core structure of the immunoglobulin is a tetramer consisting of two light and two heavy chains arranged in a "Y" configuration.
- Synthesis of diverse antibodies from a limited set of genes is made possible by combining, rearranging, and somatic mutation of immunoglobulin genes.
- The ability to synthesize new antibodies to defend against novel antigens represents the defining feature of the adaptive immune system.
- Monoclonal cell lines provide monospecific antibodies for laboratory and clinical use.
- The complement system is generally activated by complexes formed between infecting microbes and protective antibodies or between mannose rich polysaccharides on the pathogen's surface and mannose-binding protein.
- The complement system is activated by a series of proteolytic cleavage events that transform dormant zymogens into active proteases.
- Autoimmune disorders result when the immune system attacks our body's own tissues.

REFERENCES

- Andrew NC: Forging a field: the golden age of iron biology. *Blood* 2008;112:219.
- Burtis CA, Ashwood EA, Bruns DE (editors): *Tietz Textbook of Clinical Chemistry and Molecular Diagnostics*, 4th ed. Elsevier Saunders, 2006. (Chapters 20, 26, and 31 give extensive coverage of plasma proteins, complement proteins, immunoglobulins, C-reactive protein, hemoglobin, iron, and bilirubin.)
- Carroll MV, Sim RB: Complement in health and disease. *Adv Drug Disc Rev* 2011;63:965.

- Craig WY, Ledue TB, Ritchie RF: *Plasma Proteins: Clinical Utility and Interpretation*. Foundation for Blood Research, 2008.
- Fauci AS, Branwald E, Kasper DL, et al: *Harrison's Principles of Internal Medicine*, 17th ed. McGraw-Hill, 2008 (Chapters 58, 98, and 308 contain coverage of anemia and polycythemia, iron deficiency and other hypoproliferative anemias, and an introduction to the immune system).
- Ganz T: Iron homeostasis: fitting the puzzle pieces together. *Cell Metab* 2008;7:288.
- Hellman NE, Gitlin JD: Ceruloplasmin metabolism and function. *Annu Rev Nutr* 2002;22:439.
- Hentz MW, Muckenthaler MU, Gali B, et al: Two to tango: regulation of mammalian iron metabolism. *Cell* 2010;142:24.
- Lab Tests Online: <http://www.labtestsonline.org/> (A comprehensive web site provided by the American Association of Clinical Chemists that provides information on the measurement and significance of the various plasma proteins discussed in this Chapter, and also on most other lab tests.)
- Levinson W: *Review of Medical Microbiology and Immunology*, 11th ed. Appleton & Lange, 2010. (Good description of the basics of Immunology.)
- Murphy KM, Travers P, Walport M: *Janeway's Immunobiology*, 7th ed. Garland Science Publishing, 2007.
- Noris M, Remuzzi G: Overview of complement activation and regulation. *Sem Nephrol* 2013;33:479.
- Schaller H, Gerber S, Kaempfer U, et al: *Human Blood Plasma Proteins: Structure and Function*. Wiley, 2008.
- Zaheen A, Martin A: Activation-induced cytidine deaminase and aberrant germinal center selection in the development of humoral autoimmunities. *Am J Pathol* 2011;178:462.

Red Blood Cells

Peter J. Kennelly, PhD & Robert K. Murray, MD, PhD

OBJECTIVES

After studying this chapter, you should be able to:

- Understand the concept of stem cells and their importance.
- Explain why red blood cells are reliant on glucose for energy.
- Describe the roles of erythropoietin, thrombopoietin, and other cytokines in the production of red blood cells and platelets.
- Describe the enzyme systems that protect heme iron from oxidation and reduce methemoglobin.
- Identify the major components of the erythrocyte cytoskeleton.
- Summarize the causes of the major disorders affecting red blood cells.
- Describe the major function of erythrocyte band 3 protein.
- Know the biochemical bases of the ABO blood group substances.
- List the major components contained in the dense granules and α -granules in platelets.
- Describe the molecular bases of immune thrombocytopenic purpura and von Willebrand disease.

BIOMEDICAL IMPORTANCE

The evolution of a diverse array of freely circulating blood cells was critical to the development of animal life. The packaging of hemoglobin and carbonic anhydrase inside specialized cells called **erythrocytes** greatly amplified the capacity of circulating blood to carry oxygen to and carbon dioxide away from peripheral tissues. **Anemia**, a deficiency in the level of circulating hemoglobin (<120-130 g/L), compromises health by reducing the ability of the blood to supply tissues with adequate levels of oxygen. Anemia can arise from a variety of causes that include genetic abnormalities (eg, sickle cell trait, pernicious anemia), excessive bleeding, insufficiencies of dietary iron or vitamin B₁₂, or the lysis of red blood cells by invading pathogens (eg, malaria). **Platelets** help staunch the outflow of blood from damaged tissues. Deficits in platelet number or function increase a patient's vulnerability to hemorrhage by reducing the speed of formation and structural integrity of protective clots. As is the case for anemia, a low platelet count, known as **thrombocytopenia**, can be triggered by a range of factors that include bacterial infection, sulfa-containing antibiotics and certain other medications, or autoimmune reactions such as idiopathic thrombocytopenic purpura.

Other pathophysiologic syndromes, such as **von Willebrand disease** and **Glanzmann thrombasthenia**, are caused by genetic mutations that impair platelet adherence or aggregation rather than their abundance.

RED BLOOD CELLS DERIVE FROM HEMATOPOIETIC STEM CELLS

Both red blood cells and platelets turn over at a relatively high rate. Hence, replacements are constantly being produced from precursor **stem cells**. Stem cells possess a unique capacity both to produce unaltered daughter cells (**self-renewal**) and to generate a diverse range of specialized cell types (**potency**). Broadly speaking, stem cells therefore can be considered to exist in an undifferentiated state. Stem cells may be **totipotent** (capable of producing all the cells in an organism), **pluripotent** (able to differentiate into cells of any of the three germ layers), **multipotent** (produce only cells of a closely related family) or **unipotent** (produce only one type of cell). Stem cells are also classified as **embryonic** or **adult**. Since adult stem cells are more limited in their capacity to differentiate, intensive efforts are being directed toward overcoming this restriction.

Differentiation of hematopoietic stem cells is regulated by a set of secreted glycoproteins called **cytokines**. **Stem cell factor** and several **colony stimulating factors** collaborate with interleukins 1, 3, and 6 to stimulate the proliferation of hematopoietic stem cells in the bone marrow and their commitment to differentiate into one of several myeloid cell types (**Figure 53-1**). Binding of **erythropoietin** or **thrombopoietin** directs myeloid progenitor cells to eventually differentiate into erythrocytes or platelets, respectively.

RED BLOOD CELLS ARE HIGHLY SPECIALIZED

Mature Erythrocytes Are Devoid of Internal Organelles

The structure and composition of red blood cells reflects their highly specialized function: to deliver the maximum quantity of oxygen possible to tissues and aid in the removal carbon

dioxide, a waste product of cellular respiration, and urea. The interior of a red blood cell contains a massive concentration of hemoglobin, roughly one-third by weight (30-34 g/dL for an adult). This extraordinary hemoglobin capacity has been achieved, in part, by the adoption of an unusually simplified cell structure. Mature red blood cells are devoid of the intracellular organelles found in other eukaryotic cells (eg, nucleus, lysosome, Golgi apparatus, mitochondria). As a consequence, **enucleated** red blood cells are unable to reproduce.

Red blood cells possess an extensive cytoskeletal network responsible for maintaining their biconcave configuration (**Figure 53-2**). Their unusual shape enhances the exchange of oxygen and carbon dioxide between erythrocytes and tissues in two ways. First, their disc-like configuration possesses a much higher ratio of surface area to volume than more spherical geometries. Second, it enables red blood cells to fold over and squeeze through narrow capillaries whose diameter is smaller than that of the erythrocyte itself. By minimizing the distance to be traversed, these factors promote efficient gas exchange between capillary walls and the rapidly moving (up to 2 mm/s) erythrocytes.

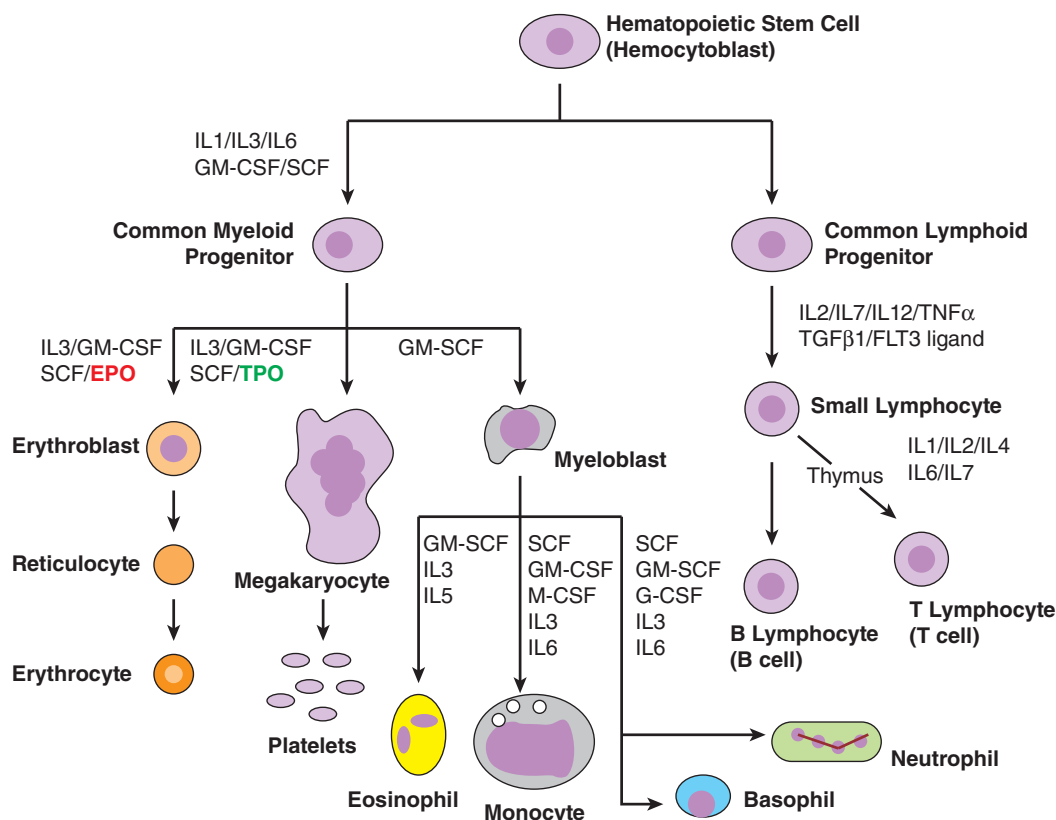

FIGURE 53-1 Hematopoiesis. Shown is a simplified and heavily abbreviated scheme indicating the paths by which hematopoietic stem cells differentiate to produce many of the more quantitatively prominent red and white blood cells. Only selected developmental intermediates are shown. The names for each cell type are indicated in **bold type**. Cell nuclei are shown in **purple**. Each arrow summarizes a multistage transition. The hormones and cytokines that stimulate each transition are listed next to the arrows. Symbols used include IL, interleukin; SCF, stem cell factor; G-CSF, granulocyte-colony stimulating factor; M-CSF, macrophage-colony stimulating factor; GM-CSF, granulocyte macrophage-colony stimulating factor; FLT3 ligand, FMS-like tyrosine kinase 3 ligand; TNF α , tumor necrosis factor α ; TGF β 1, transforming growth factor β 1; **EPO**, erythropoietin; **TPO**, thrombopoietin.

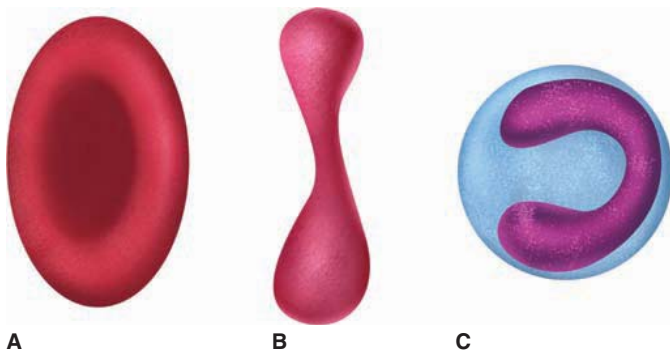

FIGURE 53-2 Red blood cells are shaped like biconcave discs. Shown are drawings of (A) a red blood cell, (B) a section through a red blood cell illustrating its biconcave shape, and (C) a red blood cell folded for passage through a narrow capillary.

Erythrocytes Generate ATP Exclusively via Glycolysis

Red blood cells lack mitochondria, and hence the enzymes of the TCA cycle, electron transport chain, β -oxidation pathway, or ATP synthase. This renders them incapable of utilizing fatty acids or ketone bodies as metabolic fuel. Consequently, red blood cells are completely reliant of glycolysis to generate ATP. Glucose enters red blood cells by **facilitated diffusion** (see Chapter 40), a process mediated by the **glucose transporter (GLUT1)**, also known as glucose permease (Table 53-1).

The glycolytic pathway in red blood cells also possesses a unique branch, or shunt, whose purpose is to isomerize 1,3-bisphosphoglycerate (1,3-BPG) to **2,3-bisphosphoglycerate (2,3-BPG)**. 2,3-BPG binds to and stabilizes hemoglobin in the T-state (see Chapter 6). Conversion of 1,3-BPG to 2,3-BPG is catalyzed by 2,3-bisphosphoglycerate mutase, a bifunctional enzyme that also catalyzes the hydrolysis of 2,3-BPG to the glycolytic intermediate 3-phosphoglycerate. A second enzyme, multiple

TABLE 53-1 Some Properties of the Glucose Transporter of the Membrane of the Red Blood Cell (GLUT1)

• It accounts for ~2% of the protein of the membrane of the RBC.
• It exhibits specificity for glucose and related D-hexoses (L-hexoses are not transported).
• The transporter functions at ~75% of its V_{max} at the physiologic concentration of blood glucose, is saturable, and can be inhibited by certain analogs of glucose.
• It is a member of a family of homologous glucose transporters found in mammalian tissues.
• It is not dependent upon insulin, unlike the corresponding carrier in muscle and adipose tissue.
• Its 492 amino acid sequence has been determined.
• It transports glucose when inserted into artificial liposomes.
• It is estimated to contain 12 transmembrane helical segments.
• It functions by generating a gated pore in the membrane to permit passage of glucose; the pore is conformationally dependent on the presence of glucose and can oscillate rapidly (~900 times/s).

inositol polyphosphate phosphatase, catalyzes the hydrolysis of 2,3-BPG to the glycolytic intermediate 2-bisphosphoglycerate. The activities of these enzymes are sensitive to pH, which insures that 2,3-BPG levels rise and fall at the appropriate times during the oxygen transport cycle.

Various aspects of the metabolism of the red cell, several of which are discussed in other chapters, are summarized in Table 53-2.

Carbonic Anhydrase Facilitates CO₂ Transport

Like oxygen, the solubility of carbon dioxide in aqueous solution is low, much too low to accommodate more than a few percent of the CO₂ produced by metabolically active tissues. However, the solubility of the hydrated form of CO₂, carbonic acid (H₂CO₃) and its protonic dissociation product, bicarbonate (HCO₃⁻), are relatively high. The presence in erythrocytes of high levels of the enzyme **carbonic anhydrase** (see Figure 6-11) enables them both to concentrate waste CO₂ by catalyzing its rapid

TABLE 53-2 Important Aspects of the Metabolism of the Red Blood Cell

• The RBC is highly dependent upon glucose as its energy source, for which its membrane contains high-affinity glucose transporters.
• Glycolysis, producing lactate, is the mode of production of ATP.
• Because RBCs lack mitochondria there is no production of ATP by oxidative phosphorylation.
• The RBC has a variety of transporters that maintain ionic and water balance.
• Production of 2,3-bisphosphoglycerate by reactions closely associated with glycolysis is important in regulating the ability of Hb to transport oxygen.
• The pentose phosphate pathway of the RBC metabolizes about 5%-10% of the total flux of glucose) and produces NADPH. Hemolytic anemia due to a deficiency of the activity of glucose-6-phosphate dehydrogenase is common.
• Reduced glutathione (GSH) is important in the metabolism of the RBC, in part to counteract the action of potentially toxic peroxides. The RBC can synthesize GSH and the NADPH required to return oxidized glutathione (G-S-S-G) to the reduced state GSH.
• The iron of Hb must be maintained in the ferrous state. Ferric iron is reduced to the ferrous state by the action of an NADH-dependent methemoglobin reductase system involving cytochrome b_5 reductase and cytochrome b_5 .
• While biosynthesis of glycogen, fatty acids, protein, and nucleic acids does not occur in the RBC, some lipids (eg, cholesterol) in the red cell membrane can exchange with corresponding plasma lipids.
• The RBC contains certain enzymes of nucleotide metabolism (eg, adenosine deaminase, pyrimidine nucleotidase, and adenylyl kinase). Deficiencies of these enzymes are involved in some cases of hemolytic anemia.
• When RBCs reach the end of their lifespan, the globin is degraded to amino acids (which are reutilized in the body), the iron is released from heme and reutilized, and the tetrapyrrole component of heme is converted to bilirubin, which is mainly excreted into the bowel via the bile.

conversion to carbonic acid, and to reverse this process in order to facilitate its expulsion in the lungs. While red blood cells carry some CO_2 in the form of hemoglobin-bound carbamates (see Chapter 6), roughly 80% is carried internally as dissolved bicarbonate.

RED BLOOD CELLS MUST BE CONTINUALLY REPLACED

About Two Million Red Blood Cells Enter the Circulation per Second

The **120 day lifespan** of a normal red blood cell requires that nearly 1% of the roughly 30 trillion erythrocytes in a typical individual must be replaced daily. This equates to a rate of production of ~2 million new red blood cells per second. Newly formed red blood cells retain portions of the ribosomes, endoplasmic reticulum, mitochondria, etc that were present in their nucleated precursors. During the ~24 hours required to complete the transition to a mature erythrocyte, these nascent red blood cells, called **reticulocytes**, retain the capacity to synthesize polypeptides under the direction of vestigial mRNA molecules.

In rare cases, genetic mutations that lead to an impairment of ribosome function, called **ribomyopathies**, can result in red blood cell hypoplasia. **Diamond-Blackfan anemia** is caused by mutations in the gene encoding for the ribosomal processing protein RPS19. **5q-syndrome**, which presents a similar clinical picture, is caused by mutations that lead to an insufficiency of ribosomal protein RPS 14.

Erythropoietin Regulates Production of Red Blood Cells

The initial stages of **erythropoiesis**, the production of red blood cells, involve stem cell factor, colony stimulating factors, and interleukins 1, 3, and 6. Commitment of myeloid progenitor cells to differentiation into erythrocytes is largely dependent on **erythropoietin (EPO)**, a glycoprotein of 166 amino acids (molecular mass about 34 kDa). EPO, which is synthesized mainly by the kidney, is released into the bloodstream in response to hypoxia. Upon reaching the bone marrow it interacts with progenitors of red blood cells via a specific transmembrane receptor. The EPO receptor consists of two different subunits organized into a number of domains. Activation of the receptor stimulates the activities of protein-tyrosine kinases involved in downstream signal transduction.

Erythropoietin is administered therapeutically to treat anemias arising from chronic kidney failure or disorders of hematopoietic stem cells (**myelodysplasia**) as well as from the collateral effects of chemical and radiological treatments for cancer. Today, recombinant DNA technology has made it possible to produce substantial amounts of erythropoietin from cultured human cells. As described in Chapter 49, attempts are being made to increase the dose-effectiveness of recombinant EPO by prolonging its half-life

in the circulation by manipulating the composition of its polysaccharide chains.

OXIDATION OF HEME IRON COMPROMISES OXYGEN TRANSPORT

Cytochrome b_5 Reductase Reduces Methemoglobin

Hemoglobin containing one or more heme irons in the ferric (Fe^{3+}) state is called **methemoglobin**. Heme groups that contain ferrous iron do not bind oxygen. Moreover, because the subunits of the hemoglobin tetramer interact in a cooperative manner (see Chapter 6), oxidation of a single heme iron can adversely impact oxygen delivery by the remaining three subunits.

The ferrous, Fe^{2+} , iron atoms in hemoglobin are susceptible to oxidation by reactive oxygen species (ROS). The ability to rescue methemoglobin by reducing ferrous iron is thus of great physiologic importance. In red blood cells, hemoglobin is regenerated from methemoglobin by the NADH-cytochrome b_5 methemoglobin reductase system. The first component of the system, the flavoprotein named **cytochrome b_5 reductase** (also known as methemoglobin reductase) transfers electrons from NADH to the second component, **cytochrome b_5** , using electrons supplied by NADH:

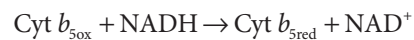

Reduced cytochrome b_5 then transfer the electrons to methemoglobin, reducing Fe^{3+} back to the Fe^{2+} state:

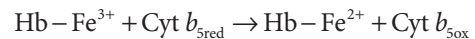

The ultimate source of the electrons used to reduce methemoglobin is glycolysis, where NAD^+ is reduced to NADH by the action of glyceraldehyde-3-phosphate dehydrogenase. The efficiency of this system is such that only trace quantities of methemoglobin are normally present in erythrocytes.

Methemoglobinemia Is Inherited or Acquired

Methemoglobinemia, the abnormal accumulation of methemoglobin, can arise from genetic abnormalities (inherited methemoglobinemia) or from the ingestion of certain drugs and chemicals (acquired methemoglobinemia) such as sulfonamides or aniline (**Table 53-3**). Since methemoglobin does not bind oxygen, affected patients often exhibit bluish discoloration of the skin and mucous membranes (cyanosis). The inherited form most commonly results from mutations that result in a deficiency in the quantity or activity of **cytochrome b_5 reductase**, although mutations that affect the properties of cytochrome b_5 have also been encountered. In rare instances, methemoglobinemia can result from mutations that render the iron atom of hemoglobin more susceptible to oxidation. Collectively referred to as hemoglobin M (HbM),

TABLE 53–3 Summary of the Causes of Some Important Disorders Affecting Red Blood Cells

Disorder	Sole or Major Cause
Iron deficiency anemia	Inadequate intake or excessive loss of iron
Methemoglobinemia	Intake of excess oxidants (various chemicals and drugs) Genetic deficiency in the NADH-dependent methemoglobin reductase system (OMIM 250800) Inheritance of HbM (OMIM 141900)
Sickle cell anemia (OMIM 603903)	Sequence of codon 6 of the β chain changed from GAG in the normal gene to GTG in the sickle cell gene, resulting in substitution of valine for glutamic acid
α -Thalassemias (OMIM 141800)	Mutations in the α -globin genes, mainly unequal crossing-over and large deletions and less commonly nonsense and frameshift mutations
β -Thalassemias (OMIM 141900)	A very wide variety of mutations in the β -globin gene, including deletions, nonsense and frameshift mutations, and others affecting every aspect of its structure (eg, splice sites, promoter mutants)
Megaloblastic anemias	Deficiency of vitamin B12. Decreased absorption of B ₁₂ , often due to a deficiency of intrinsic factor, normally secreted by gastric parietal cells Deficiency of folic acid. Decreased intake, defective absorption, or increased demand (eg, in pregnancy) for folate
Hereditary spherocytosis ^a (OMIM 182900)	Deficiencies in the amount or in the structure of α - or β -spectrin, ankyrin, band 3, or band 4.1.
Glucose-6-phosphate dehydrogenase (G6PD) deficiency ^a (OMIM 305900)	A variety of mutations in the gene (X-linked) for G6PD, mostly single-point mutations
Pyruvate kinase (PK) deficiency ^a (OMIM 266200)	A variety of mutations in the gene for the R (red cell) isozyme of PK
Paroxysmal nocturnal hemoglobinuria ^a (OMIM 311770)	Mutations in the PIG-A gene, affecting synthesis of GPI-anchored proteins

^aOMIM numbers apply only to disorders with a genetic basis.

these abnormal forms can arise from mutations that affect the histidine residues located proximal or distal to the heme iron. In HbM_{Iwate}, for instance, His87 in the α -subunit is replaced by Tyr. In HbM_{Hyde Park}, His92 in the β -subunit is replaced by Tyr. In HbM_{Boston}, His58 in the α -subunits of hemoglobin is replaced by Tyr, while in HbM_{Saskatoon}, His92 in the β -subunit is replaced by Tyr. One exception to this pattern is HbM_{Milwaukee-1}, in which Val67 of the β -subunit is replaced by Glu. All known carriers of HbM are heterozygotes.

Superoxide Dismutase, Catalase, & Glutathione Protect Blood Cells from Oxidative Stress & Damage

The radical anion **superoxide**, O₂⁻, is generated in red blood cells by the autoxidation of hemoglobin to methemoglobin. This potent **reactive oxygen species (ROS)** can react with and damage a wide range of biomolecules that include proteins, lipids, and nucleotides (see Chapter 58). Approximately 3% of the hemoglobin of human blood undergoes auto-oxidation each day. In addition, oxidation of the iron storage protein ferritin by superoxide can result in the release of free Fe²⁺ and the subsequent iron-catalyzed generation of OH[•] (see Figure 58–2). Superoxide may thus provide the trigger for the tissue damage that occurs in persons suffering from

iron-overload, the presence of abnormally high levels of iron in the body. Iron overload is characteristic of individuals suffering from **hereditary hemochromatosis**, a genetic condition that causes the body to absorb excessive quantities of dietary iron. Another endogenous source of superoxide is the enzyme **NADPH-hemoprotein reductase** (cytochrome P450 reductase, see Chapter 12), which catalyzes the reduction of the Fe³⁺ in methemoglobin to Fe²⁺, thereby regenerating functionally competent hemoglobin (see Chapter 6).

Deficiency of Glucose-6-Phosphate Dehydrogenase Is an Important Cause of Hemolytic Anemia

The limited suite of metabolic pathways present in red blood cells renders them completely reliant on the **pentose phosphate pathway** (see Chapter 20) or, to be more specific, the X-linked enzyme **glucose-6-phosphate dehydrogenase** for the reduction of NADP⁺ to NADPH. Reduced NADPH is needed for the reduction of GSSG to GSH, a key intracellular antioxidant, by the enzyme glutathione reductase. A deficiency in glucose-6-phosphate dehydrogenase renders red blood cells hypersensitive to oxidative stress. One of the hallmarks of oxidative stress in red blood cells is the formation

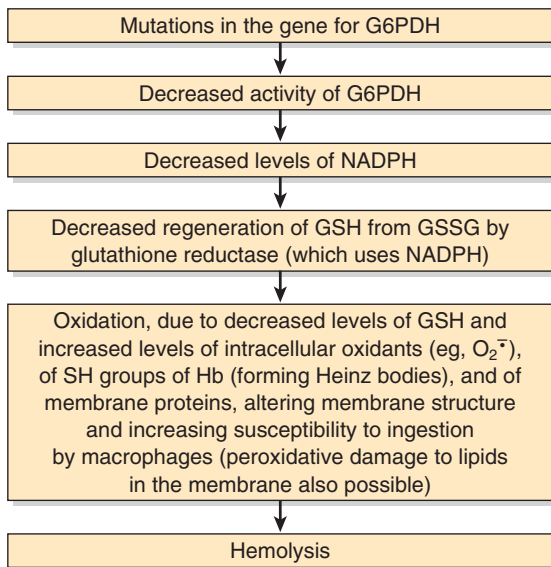

FIGURE 53-3 Summary of probable events causing hemolytic anemia due to deficiency of the activity of glucose-6-phosphate dehydrogenase (OMIM 305900).

of **Heinz bodies**, insoluble aggregates consisting of hemoglobin molecules whose—SH groups have become oxidized, and which stain purple with cresyl violet.

Deficiency of glucose-6-phosphate dehydrogenase activity is common in natives of tropical Africa, the Mediterranean, certain parts of Asia, and in North America among African Americans. Individuals harboring this deficiency are vulnerable to attacks of hemolytic anemia, resulting from the inability to generate sufficient reduced glutathione to combat episodes of oxidative stress (Figure 53-3). Symptom inducing surges in ROS can be triggered by factors such as ingestion of **sulfonamide** drugs or the antimalarial **primaquine**, consumption of pro-oxidant containing foods such as broad beans (*Vicia faba*), or exposure to chemicals such as naphthalene. The most common of all **enzymopathies** (diseases caused by abnormalities of enzymes), more than 400 million people are estimated to carry one of the over 140 genetic variants of glucose-6-phosphate dehydrogenase. Like sickle cell trait, the persistence of these genetic variants has been attributed to their potential to confer enhanced resistance to malaria.

Hemolytic Anemias Can Be Caused by Extrinsic, Intrinsic, or Membrane-Specific Factors

Hemolytic anemia can be triggered by a variety of factors other than deficiencies in glucose-6-phosphate dehydrogenase (Figure 53-4). **Extrinsic** causes (beyond the erythrocyte membrane) include **hypersplenism**, a condition in which the enlargement of the spleen causes red blood cells to become sequestered within this organ. Erythrocytes may also be lysed if attacked by incompatible antibodies present in intravenously administered plasma or blood (eg, **transfusion reaction**). Immunological incompatibilities can also arise when an Rh⁺ fetus is carried by an Rh⁻ mother (**Rh disease**) or as

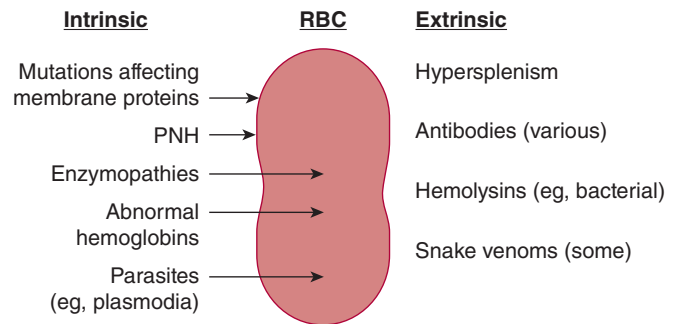

FIGURE 53-4 Schematic diagram of some causes of hemolytic anemias. Extrinsic causes include hypersplenism, various antibodies, certain bacterial hemolysins and some snake venoms. Causes intrinsic to the red cells include mutations that affect the structures of membrane proteins (eg, in hereditary spherocytosis and hereditary elliptocytosis), PNH (paroxysmal nocturnal hemoglobinuria, see Chapter 47), enzymopathies, abnormal hemoglobins, and certain parasites (eg, plasmodia causing malaria).

a consequence of an autoimmune disorder (eg, **warm** or **cold antibody hemolytic anemias**). Some infectious and toxic agents lyse red blood cells by directly undermining the structural integrity of the erythrocyte membrane. For example, the venoms of various reptiles and insects contain phospholipases or proteases that catalyze the hydrolytic breakdown of membrane components. Similarly, some infectious bacteria, including certain strains of *Escherichia coli* and clostridia, secrete lytic factors comprised of proteins, lipids, or a combination thereof called **hemolysins**. **Parasitic** infections (eg, the plasmodia causing malaria) are also important causes of hemolytic anemias in certain geographic areas.

The root cause of many hemolytic anemias such as glucose-6-phosphate dehydrogenase deficiency are intracellular, also called **intrinsic**. Deficiency of **pyruvate kinase** is the second most common, albeit infrequent, enzyme deficiency associated with hemolytic anemia. Insufficiency of this key glycolytic enzyme impairs the production of ATP. This impacts multiple aspects of membrane integrity such as the ability to export excess water and ions such as Na⁺. Defects in the composition or structure of hemoglobin, called **hemoglobinopathies**, constitute the second major class of intrinsically caused hemolysis. Most hemoglobinopathies such as sickle cell anemia and the various thalassemias (see Chapter 6) are genetic in nature.

Membrane-specific factors that render red blood cells vulnerable to lysis include mutations that affect the cytoskeletal proteins responsible for maintaining their biconcave shape and resistance to osmotic pressure (see below). The most important of these defects include **hereditary spherocytosis** and **hereditary elliptocytosis**, which arise from abnormalities in the amount or structure of the cytoskeletal protein **spectrin**. **Paroxysmal nocturnal hemoglobinuria** (see Chapter 46) is caused by defects in the synthesis of the glycoposphatidylinositol groups that anchor certain proteins such as acetylcholinesterase and decay-accelerating factor to the surface of the erythrocyte membrane.

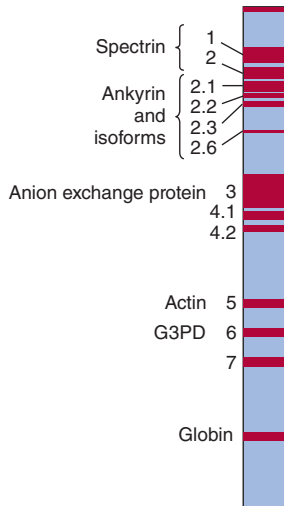

FIGURE 53-5 Major membrane proteins of the human red blood cell. Proteins separated by SDS-PAGE were detected by staining with Coomassie blue dye. (Reproduced, with permission, from Beck WS, Tepper RI: Hemolytic anemias III: membrane disorders. In: *Hematology*, 5th ed. Beck WS (editor). The MIT Press, 1991.)

THE RED BLOOD CELL MEMBRANE

Early analyses by SDS-PAGE of the polypeptides present in red blood cells revealed 10 major proteins (Figure 53-5). These proteins were initially designated based upon their migration on SDS-PAGE, with the slowest migrating (highest molecular mass) designated band 1 protein, also known as spectrin (Table 53-4). As illustrated by Figure 53-6, certain of these proteins are glycosylated and several span the membrane

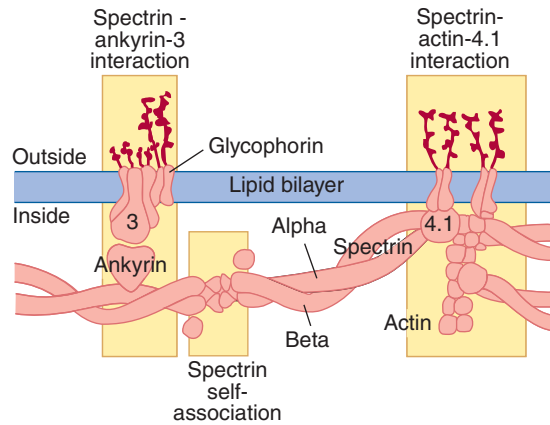

FIGURE 53-6 Interactions of cytoskeletal proteins with each other and with certain integral proteins of the membrane of the red blood cell. (Reproduced, with permission, from Beck WS, Tepper RI: Hemolytic anemias III: membrane disorders. In: *Hematology*, 5th ed. Beck WS (editor). The MIT Press, 1991.)

bilayer (integral membrane proteins), while others associate with its surface, generally via protein-protein interactions (peripheral membrane proteins).

The Red Blood Cell Membrane Contains Anion Exchange Protein & the Glycophorins

Band 3 protein is a transmembrane glycoprotein oriented with its carboxyl terminal end projecting from the external surface of the erythrocyte membrane and its amino terminal end

TABLE 53-4 Principal Proteins of the Red Cell Membrane

Band Number ^a	Protein	Integral (I) or Peripheral (P)	Approximate Molecular Mass (kDa)
1	Spectrin (α)	P	240
2	Spectrin (β)	P	220
2.1	Ankyrin	P	210
2.2	Ankyrin	P	195
2.3	Ankyrin	P	175
2.6	Ankyrin	P	145
3	Anion exchange protein	I	100
4.1	Unnamed	P	80
5	Actin	P	43
6	Glyceraldehyde-3-phosphate dehydrogenase	P	35
7	Tropomyosin	P	29
8	Unnamed	P	23
	Glycophorins A, B, and C	I	31, 23, and 28

^aThe band number refers to the position of migration on SDS-PAGE (see Figure 53-5), in which glycophorins are not shown. A number of other components (eg, 4.2 and 4.9) are not listed.

Source: Adapted from Lux DE, Tse WT: Hereditary spherocytosis and hereditary elliptocytosis. In: *The Metabolic Basis of Inherited Disease*, 8th ed. Scriver CR, Beaudet AL, Valle D, et al (editors). McGraw-Hill, 2001. Chapter 183.

from the cytosolic face. Thought to exist as a dimer, band 3 protein is a **multipass** membrane protein whose polypeptide chain crosses the bilayer 14 times. The principle function of this **anion exchange protein** is to provide a channel within the membrane through which chloride and bicarbonate anions can be exchanged. At the tissues, bicarbonate generated from the hydration of CO_2 is exchanged for chloride. At the lungs, where carbon dioxide is exhaled, this process is reversed. The amino terminal end serves as an anchoring point for several red blood cell proteins, including band 4.1 and 4.2 proteins, ankyrin, hemoglobin, and several glycolytic enzymes.

Glycophorins A, B, and C are **single-pass** transmembrane proteins (the polypeptide chain crosses the membrane only once). The 23 amino acid transmembrane segment is α -helical in configuration. Glycophorin A, the predominant form, is heavily glycosylated. The amino terminal end of this 131-amino acid polypeptide is modified by 16 oligosaccharide chains, 15 of them O-linked, that account for roughly 60% of its mass. The oligosaccharide chains of glycophorin A account for nearly 90% of the sialic acid residues bound to the red cell membrane. The carboxyl terminal end extends into the cytosol and binds to band 4.1 protein, which in turn binds to spectrin. **Polymorphism** of glycophorin A provides the basis of the MN blood group system (see below). Some viral and bacterial pathogens, such as influenza virus and *Plasmodium falciparum*, target erythrocytes by recognizing and binding to glycophorin A. Intriguingly, individuals whose red cells lack glycophorin A exhibit no adverse effects.

Spectrin, Ankyrin, & Other Peripheral Membrane Proteins Help Determine the Shape & Flexibility of the Red Blood Cell

In order to maximize the efficiency of gas exchange, red blood cells must possess the structural strength to maintain their biconcave shape, yet remain sufficiently flexible to squeeze through peripheral capillaries and the sinusoids of the spleen. The red blood cell membrane's lipid bilayer, which is inherently fluid, contributes significantly to the deformability of the erythrocyte membrane. This flexible bilayer is pulled into the biconcave shape by a strong but flexible network of **cytoskeletal proteins** (Figure 53–6).

Spectrin is the most abundant protein of the erythrocyte cytoskeleton. It is composed of two polypeptides more than 2100 residues in length: spectrin 1 (α chain) and spectrin 2 (β chain). The α and β chains of each spectrin dimer intertwine in an antiparallel orientation to form a highly extended structural unit ≈ 100 nm in length. Normally, two spectrin dimers self-associate head-to-head to form an approximately 200 nm long tetramer that is linked to the inner surface of the plasma membrane (and is bridged to other spectrin tetramers) via ankyrin, actin, and band 4.1 protein. The result is an internal mesh, the cytoskeleton, that is strong enough to maintain cell shape and resist swelling due to osmotic pressure, yet flexible enough to allow the erythrocyte to fold when needed.

Ankyrin is a pyramid-shaped protein that **binds spectrin**. In turn, ankyrin binds tightly to band 3, securing attachment of spectrin to the membrane. Ankyrin is sensitive to proteolysis, accounting for the appearance of bands 2.2, 2.3, and 2.6, all of which are derived from band 2.1.

Actin (band 5) exists in red blood cells as short, double-helical filaments of F-actin. The tail end of spectrin dimers binds to actin. Actin also binds to protein 4.1.

Protein 4.1, a globular protein, binds tightly to the tail end of spectrin, near the actin-binding site of the latter, and thus is part of a protein 4.1-spectrin-actin ternary complex. Protein 4.1 also binds to the integral proteins glycophorin A and glycophorin C, thereby attaching the ternary complex to the membrane. In addition, protein 4.1 may interact with certain membrane phospholipids, thus connecting the lipid bilayer to the cytoskeleton.

Certain other less quantitatively prominent proteins, such as band 4.9, adducin, and tropomyosin, also participate in **cytoskeletal assembly**.

Abnormalities in the Amount or Structure of Spectrin Cause Hereditary Spherocytosis & Elliptocytosis

Hereditary spherocytosis, a genetic disease transmitted as an autosomal dominant, affects about 1:5000 persons of Northern European ancestry. It is characterized by the presence of spherocytes (spherical red blood cells, with a low surface-to-volume ratio) in the peripheral blood, by a **hemolytic anemia**, and by splenomegaly. Spherocytes are more vulnerable to lysis when exposed to lower than normal osmotic pressure, since their spherical shape offers little capacity to accommodate additional water. Their abnormal shape also renders them less deformable and more prone to destruction in the spleen, thus greatly shortening their life in the circulation.

Hereditary spherocytosis is caused by a deficiency in the amount of **spectrin** or abnormalities of its structure that undermine its capacity to associate with other cytoskeletal components. The consequent weakening of the links that anchor the erythrocyte membrane to the cytoskeleton leads to the adoption of the spherocytic shape. Hereditary spherocytosis also can result from mutations that produce abnormalities in ankyrin or in bands 3, 4.1, or 4.2. The anemia associated with hereditary spherocytosis is generally relieved by surgical removal of the patient's spleen (**splenectomy**).

Hereditary elliptocytosis also results from genetic disorders that generate abnormalities in **spectrin** or, less frequently, in band 4.1 protein or in **glycophorin C**. It can readily be distinguished from hereditary spherocytosis by virtue of the fact that the affected red blood cells assume an elliptic, disk-like shape.

THE BIOCHEMICAL BASIS OF THE ABO SYSTEM

Approximately 30 human blood group systems have been recognized, the best known of which are the **ABO**, **Rh** (Rhesus), and **MN** systems. The term "**blood group**" applies to a defined

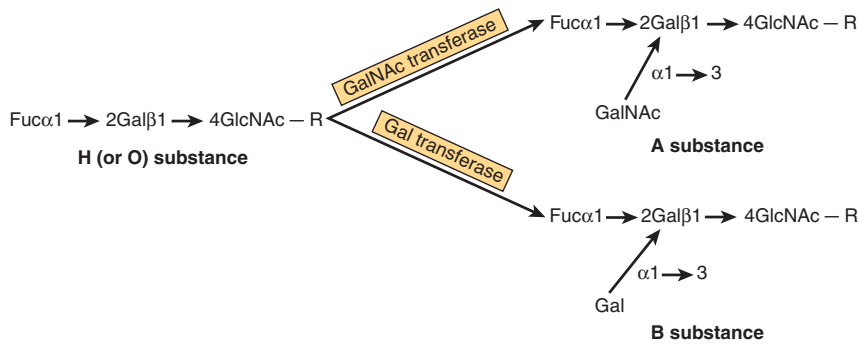

FIGURE 53-7 Diagrammatic representation of the structures of the H, A, and B blood group substances. R represents a long complex oligosaccharide chain, joined either to ceramide where the substances are glycosphingolipids, or to the polypeptide backbone of a protein via a serine or threonine residue where the substances are glycoproteins. Note that the blood group substances are biantennary; ie, they have two arms, formed at a branch point (not indicated) between the GlcNAc—R, and only one arm of the branch is shown. Thus, the H, A, and B substances each contain two of their respective short oligosaccharide chains shown above. The AB substance contains one type A chain and one type B chain.

system of red blood cell antigens (blood group substances) controlled by a genetic locus having a variable number of alleles (eg, A, B, and O in the ABO system). The term “**blood type**” refers to the antigenic phenotype, usually recognized by the use of appropriate antibodies.

The ABO System Is of Crucial Importance in Blood Transfusion

The ABO system was discovered by Landsteiner in 1900 while investigating the basis of compatible and incompatible transfusions in humans. The membranes of the erythrocytes of most individuals contain one blood group substance of type A, type B, type AB, or type O. Individuals of **type A** have anti-B antibodies in their plasma that will agglutinate type B or type AB blood. Individuals of **type B** have anti-A antibodies that will agglutinate type A or type AB blood. **Type AB** blood has neither anti-A nor anti-B antibodies, and has been designated the **universal recipient**. **Type O** blood has neither A nor B antigens, and has been designated the **universal donor**. The body does not usually produce antibodies to its own constituents. Thus, type A individuals do not produce antibodies to their own blood group substance A, but do possess antibodies to the foreign blood group substance, B. Anti-B antibodies probably arose because similar structures are present in intestinal microorganisms to which the body is exposed early in life. Type O individuals possess both A and B antibodies, but their erythrocytes lack the A and B antigens. The above description has been simplified considerably. There are, for example, two subgroups of type A: A_1 and A_2 . The genes responsible for production of the ABO substances are present on the long arm of chromosome 9. There are **three alleles**, two of which are codominant (A and B) and the third (O) recessive; these ultimately determine the four phenotypic products: the A, B, AB, and O substances.

The ABO Antigens Are Glycosphingolipids & Glycoproteins

The **ABO antigens** are complex oligosaccharides present in most cells of the body and in certain secretions (**Figure 53-7**). These oligosaccharides are bound to membrane proteins or lipids, and are collectively referred to as ABO substances. For red blood cells, the membrane oligosaccharides that determine the antigenic natures of the ABO substances appear to be mostly present in **glycosphingolipids**, whereas in secretions the same oligosaccharides are present in **glycoproteins**. Their presence in secretions is determined by a gene designated *Se* (for secretor), which codes for a specific **fucosyl (Fuc) transferase** in secretory organs, such as the exocrine glands, but which is not active in red blood cells. Individuals of *SeSe* or *Sese* genotypes secrete either or both A and B antigens whereas individuals of the *sese* genotype do not. However, their red blood cells can express the A and B antigens.

The A Gene Encodes a GalNAc Transferase, the B Gene a Gal Transferase, & the O Gene an Inactive Product

H substance, the blood group substance found in persons of type O, is the precursor of both the A and B substances (**Figure 53-7**). H substance is formed by the action of a **fucosyltransferase** coded for by the H locus. This enzyme catalyzes the addition of the terminal fucose in an $\alpha 1 \rightarrow 2$ linkage onto the terminal Gal residue of its precursor:

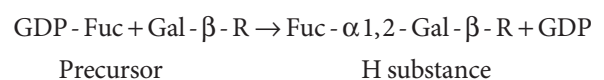

A substance contains an additional GalNAc, while **B substance** contains an additional Gal, linked as indicated. These differences are the result of a mutation that alters the specificity of the glycosyltransferase that adds the additional monosaccharide. The *A* gene encodes a UDP-GalNAc-specific **GalNAc transferase** that adds the terminal GalNAc to H substance. The *B* gene encodes a UDP-Gal-specific **Gal transferase** that adds the Gal residue to H substance. Individuals of **type AB** possess both enzymes, and thus have two oligosaccharide chains (Figure 53–7), one terminated by GalNAc and the other by Gal.

Anti-A antibodies are directed to the additional GalNAc residue present in the A substance, and anti-B antibodies are directed toward the additional Gal residue found in the B substance. For blood group A substance, GalNAc is the **immunodominant sugar** (ie, the one determining the specificity of the antibody formed), whereas Gal is the immunodominant sugar of the B substance. Individuals of type O have a frame shift mutation in the gene encoding the terminal glycosyltransferase that results in the production of an inactive protein. Thus, H substance is their ABO blood group substance.

The *h* allele of the H locus codes for an inactive fucosyltransferase. Individuals of the *hh* genotype cannot generate H substance, the precursor of the A and B antigens, even though they may possess the enzymes necessary to convert H substance to the A or B substances. Individuals carrying the *hh* genotype will have red blood cells of type O, referred to as the Bombay phenotype (O_h).

PLATELETS

Platelets Contain Mitochondria, But Lack a Nucleus

In response to thrompoietin, the megakaryocytes that constitute the progenitors of red blood cells can fragment to form platelets (Figure 53–1). Like red blood cells, platelets lack a nucleus, but unlike erythrocytes they possess mitochondria, lysozymes, and a tubular network that forms an **open canalicular system**. This honeycomb of channels increases the surface area of the platelets, which are spheroidal at rest, thereby facilitating the secretion of various endocrine and coagulation factors upon stimulation (see Chapter 55). These factors are stored inside the platelets within densely packed secretory vesicles, called **dense granules**, which contain Ca^{2+} , ADP and serotonin, and **α -granules**, which contain fibrinogen, fibronectin, platelet-derived growth factor, von Willebrand factor, other coagulation factors. Under normal circumstances, these small (2 μ m diameter), enucleated cells circulate at a density of 2 to 4 $\times 10^5$ platelets per milliliter of blood. While platelets derive the majority of their energy from metabolizing glucose, their mitochondria enable them to generate ATP via the β -oxidation of fatty acids. The mechanisms by which

platelets become activated to participate in formation of a clot are discussed in Chapter 55.

Platelet Disorders Compromise Hemostasis

Abnormalities in platelet number or function can have serious biomedical consequences. **Acute coronary syndrome** is characterized by the formation of enlarged, hyperreactive platelets, resulting in an increased risk of thrombosis, the formation of blood clots within the circulation. The presence of larger than normal platelets also correlates with an increased frequency of myocardial infarction.

Immune thrombocytopenic purpura is an autoimmune disorder marked by depressed platelet counts (**thrombocytopenia**) caused by the generation of antibodies against the patient's own platelets. Platelets whose surface is decorated with antibodies are subject to clearance from the circulation by splenic macrophages. In some instances, platelet autoantibodies will bind to differentiating megakaryocytes, depressing platelet production. Thrombocytopenia also can occur when persons who are homozygous for a mutant variant of glycoprotein IIb/IIIa in which the leucine 33 is replaced by proline receive blood from a donor that is homo- or heterozygous for the wild-type form of this major platelet antigen. Exposure to the donor's platelets triggers the production of **alloantibodies** that attack not only the donated platelets, but also the patient's endogenous platelets. In **neonatal alloimmune thrombocytopenia**, which affects roughly 1 in 200 term pregnancies, antibodies from the mother's circulation cross the placental barrier and attack platelets in the fetus' circulatory system.

Thrombocytopenia also can be induced by drugs such as Tamoxifen, Ibuprofen, Vancomycin, and many sulfonamides. The symptoms of **hemolytic-uremic syndrome**, a disease of infants characterized by progressive kidney failure, include both thrombocytopenia and hemolytic anemia. The abnormal bleeding associated with **von Willebrand disease** is caused by a genetic defect that compromises the ability of platelets to adhere to the endothelium, rather than a deficit in platelet number. Other bleeding disorders resulting from defects in platelet adherence include **Bernard-Soulier syndrome** (genetically inherited deficiency in glycoprotein 1b), and **Glanzmann thrombasthenia** (genetically inherited deficiency in the glycoprotein IIb/IIIa complex).

RECOMBINANT DNA TECHNOLOGY HAS HAD A PROFOUND IMPACT ON HEMATOLOGY

Recombinant DNA technology has had a major impact on many aspects of hematology. The bases of the **thalassemias** and of many **disorders of coagulation** (see Chapter 55) have

been greatly clarified by investigations utilizing gene cloning and DNA sequencing. The study of oncogenes and chromosomal translocations has advanced understanding of the **leukemias**. As discussed above, cloning techniques have made available therapeutic amounts of **erythropoietin** and **other growth factors**. Deficiency of **adenosine deaminase**, a condition that affects lymphocytes particularly, was the first disease to be treated by gene therapy. In 1990, Dr. William French Anderson introduced a new copy the gene, carried on a retroviral vector, into a 4-year-old girl suffering from severe combined immunodeficiency (Bubble boy disease). Although the patient is still required to take medications, the replacement gene has remained stable into adulthood.

SUMMARY

- Major causes of anemia include blood loss, deficiencies of iron, folate and vitamin B₁₂, and various factors that cause hemolysis.
- The shape of the red blood cell contributes to the efficiency of gas exchange and to its ability to undergo deformation that facilitates its passage through capillaries.
- The production of red cells and platelets is regulated by erythropoietin, thrombopoietin, and other cytokines.
- Mature red blood cells lack internal organelles, and therefore are dependent upon glycolysis to generate ATP.
- 2,3-Bisphosphoglycerate mutase isomerizes the glycolytic intermediate 1,3-bisphosphoglycerate to form the 2,3-bisphosphoglycerate, which stabilizes T-state hemoglobin.
- Methemoglobin is unable to transport oxygen. Both genetic and acquired causes of methemoglobinemia are recognized.
- Cytochrome b₅ reductase reduces the Fe³⁺ of methemoglobin to Fe²⁺, restoring function.
- The red cell contains a battery of cytosolic enzymes—superoxide dismutase, catalase, and glutathione peroxidase—that catalyze the neutralization of powerful oxidants (ROS) generated during its metabolism.
- Genetically determined deficiency of the activity of glucose-6-phosphate dehydrogenase, which produces NADPH, is an important cause of hemolytic anemia.
- Cytoskeletal proteins such as spectrin, ankyrin, and actin, interact with specific integral membrane proteins to help regulate the shape and flexibility of red blood cells.
- Deficiency of spectrin results in hereditary spherocytosis and hereditary elliptocytosis, both causes of hemolytic anemia.
- Band 4.1 is transmembrane protein that facilitates the exchange of bicarbonate and chloride ions by erythrocytes.
- The ABO blood group substances in the red cell membrane are complex glycosphingolipids. The immunodominant sugar of A substance is *N*-acetyl-galactosamine, whereas that of the B substance is galactose. O substance contains neither of these two sugar residues in the particular linkages found in the A and B substances.
- Platelets are small, enucleated fragments of larger precursor cells called megakaryocytes.
- When activated, platelets release effector molecules and fibrinogen stored in secretory granules.
- A genetic mutation that impairs the ability of platelets to adhere is the cause of von Willebrand disease, a bleeding disorder.

REFERENCES

- Dzierzak E, Philipsen S: Erythropoiesis: development and differentiation. *Cold Spring Harb Perspect Med* 2013;3:a011601.
- Fauci AS, Braunwald E, Kasper DL, et al (editors): *Harrison's Principles of Internal Medicine*, 17th ed. McGraw-Hill, 2008. (Chapters 58, 61, & 98–108 deal with various blood disorders. Chapters 66–68 deal with various aspects of hematopoietic and other stem cells).
- Hofmann R, Benz EJ Jr, Shattal SJ, et al (editors): *Hematology: Basic Principles and Practice*, 4th ed. Elsevier Churchill Livingstone, 2005.
- Imlay JA: Cellular defenses against superoxide and hydrogen peroxide. *Annu Rev Biochem* 2008;77:755.
- Israels SJ (editor): *Mechanisms in Hematology*, 4th ed. Core Health Sciences Inc, 2011.
- Martin JF, Kristensen SD, Mathur A, et al: The causal role of megakaryocyte platelet hyperactivity in acute coronary syndromes. *Nat Rev Cardiol* 2012;9:658.
- Naria A, Ebert BL: Ribosomopathies: human disorders of ribosome dysfunction. *Blood* 2010;115:3196.
- Orkin SH, Higgs DR: Sickle cell disease at 100 years. *Science* 2010;329:291.
- Smyth SS, Whiteheart S, Italiano JE Jr, Coller BS: Platelet morphology, biochemistry, and function. In: *Williams Hematology*, 8th ed. Kaushansky K, Lichtman MA, Beutler E, et al (editors). McGraw-Hill, 2010;1735.
- Weatherall DJ: The inherited diseases of hemoglobin are an emerging global health problem. *Blood* 2010;115:4331.
- Whichard ZL, Sarkar CA, Kimmel M, Corey SJ: Hematopoiesis and its disorders: a systems biology approach. *Blood* 2010;115:2339.

White Blood Cells

Peter J. Kennelly, PhD & Robert K. Murray, MD, PhD

OBJECTIVES

After studying this chapter, you should be able to:

- Understand that white blood cells work in concert to combat infection and to trigger an inflammatory response.
- Describe the basic steps in elimination of infectious microorganisms by phagocytosis.
- Describe the role of chemotaxis in leukocyte function.
- List the key components found within the granules of phagocytes as well as basophils and their primary functions.
- List the reactive oxygen species produced during the respiratory burst.
- Explain the basis for the physiological effects caused by defects in the NADPH oxidase system.
- Explain the molecular basis of type 1 leukocyte adhesion deficiency.
- Describe how neutrophils and eosinophils entrap parasites using NETs (neutrophil extracellular traps).
- Describe the role of the helper T cells in the production of new antibodies.
- Define the term cytokine and describe the key characteristics of interleukins, interferons, prostaglandins, and leukotrienes.

BIOMEDICAL IMPORTANCE

White blood cells, or **leukocytes**, serve as key sentries and potent defenders against invading pathogens. The most abundant type of white blood cell, called **neutrophils**, ingest and destroy invading bacteria and fungi, a process known as **phagocytosis**. Larger parasites are phagocytized by **eosinophils**. Circulating **monocytes** migrate from the bloodstream to diseased tissues, where they differentiate into phagocytic **macrophages**. **Granulocytes** such as **basophils** and **mast cells** release stored effectors that attract additional leukocytes to the site of infection and trigger an inflammatory response. **B lymphocytes** generate and release protective antibodies with the assistance of **T lymphocytes**. Other lymphocytes, such as **cytotoxic T cells** and **natural killer cells**, target virally infected and malignantly transformed host cells.

Malignant neoplasms of blood-forming tissues, called **leukemias**, can lead to the uncontrolled production of one or more of the major classes of white blood cells. The hyperactivation of granulocytes that occurs as part of an allergic response can, in extreme cases, lead to **anaphylaxis** and death. Damage to or infection of the bone marrow can lead to **leukopenia**, a depression in

the production of white blood cells. The resulting deficit in the levels of circulating leukocytes can leave the affected individual vulnerable to infection (**immunocompromised**). Leukopenia can result from physical injury, chemotherapy, ionizing radiation, infection by the **Epstein-Barr virus** (mononucleosis), an autoimmune response (**Lupus**), or the displacement of bone marrow cells by fibrous tissues (**myelofibrosis**).

DEFENSE AGAINST INFECTION REQUIRES MULTIPLE CELL TYPES

The white blood cells, or **leukocytes**, are key participants in the **acute inflammatory response**, a multicomponent process that defends the body against infectious organisms and ameliorates the impact of tissue infection or morbidity. The principal steps in an inflammatory response include (1) an increase of vascular permeability, (2) the entry of activated leukocytes into the tissues, (3) activation of platelets, and (4) spontaneous subsidence (resolution) if the invading microorganisms have been dealt with successfully. **Basophils** secrete hematologic effectors such as histamine (**Figure 54–1**) that facilitate the accumulation

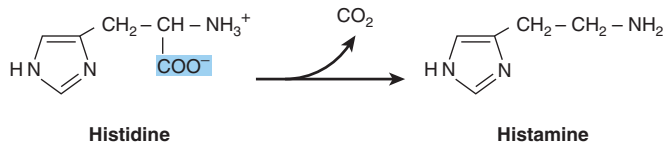

FIGURE 54-1 Structures of histidine and its decarboxylation product, histamine.

of fluid within infected or damaged tissues as well as chemokines that attract additional **neutrophils**. The activated neutrophils encapsulate invading bacteria within membrane vesicles (**phagocytosis**) and destroy them using a combination of hydrolytic enzymes, reactive oxygen species (ROS), and antimicrobial peptides. Circulating **monocytes** are the precursors of phagocytic **macrophages**, which phagocytize infected and damaged host cells. **Lymphocytes** produce protective antibodies that target foreign invaders and tag them for elimination.

Leukocytes, unlike red blood cells and platelets, possess a full complement of internal organelles. The nuclei of many leukocytes exhibit marked deviations from the compact, spherical organelle present in most eukaryotic cells. Monocyte nuclei, for example, are unusually large and noticeably irregular in shape. The nuclei in **polymorphonuclear leukocytes**, such as neutrophils and eosinophils, segment into multiple lobes.

MULTIPLE EFFECTORS REGULATE THE PRODUCTION OF WHITE BLOOD CELLS

Most white blood cells turn over rapidly and thus must be continually replaced. The lifetime of a circulating myeloid leukocyte, for example, ranges from a few hours to a few days, while most lymphocytes persist for only a few weeks in the blood. A notable exception to this pattern is **memory lymphocytes**, which may live for several years. The production of monocytes and granulocytes proceeds via the formation of a **common myeloid progenitor**, while differentiation of hematopoietic stem cells into lymphocytes proceeds via the formation of a **common lymphoid progenitor** (see Figure 53-1). The proliferation of

hematopoietic stem cells and determination of their ultimate fate is controlled by the concerted influences of multiple effector molecules. Stem cell growth factor, granulocyte-macrophage colony stimulating factor, and interleukins 5 and 6, for example, stimulate the production of granulocytes (neutrophils, eosinophils, basophils) and monocytes, a process that proceeds via the formation of **myeloid progenitor cells**. Tumor necrosis factor α , transforming growth factor β 1, and interleukins 2 and 7 promote the formation of **lymphoid progenitor cells** and their eventual maturation into B- and T-lymphocytes.

LEUKOCYTES ARE MOTILE

Leukocytes Migrate in Response to Chemical Signals

Leukocytes can be found throughout the body, migrating from the blood to sites of injury or infection in response to chemical signals, a process referred to as **chemotaxis**. Locomotion takes place via a stepwise, **amoeboid** mechanism. Impelled by the proteins of the cytoskeleton, the white blood cell extends a projection, called a pseudopod. Once the pseudopod anchors itself, the cytoskeletal proteins associated with the main body of the cell contract, squeezing the cell's contents toward and into the pseudopod. The pseudopod fills with cytoplasm and organelles, forming a new, translocated cell body. The deflated remains of the old cell body are absorbed and a new pseudopod extends to initiate the next step.

White blood cells begin their migration from the bloodstream into the surrounding tissues by squeezing through capillary walls. Called **diapedesis**, this process mirrors amoeboid motion in its reliance on the ability of cytoskeletal proteins to dramatically contort the shape of the leukocyte. The process begins with the extension of a thin, pseudopod-like projection between the cells that comprise the capillary epithelium (**Figure 54-2**). As with amoeboid motion, the contents of the cell then are squeezed through the narrow passage formed by the projection into the distal end, which fills to form a new cell body on the opposite side of the capillary wall.

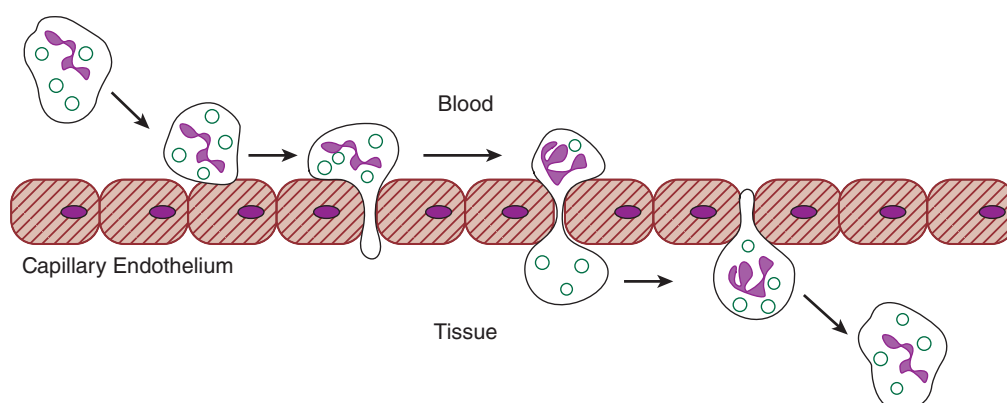

FIGURE 54-2 Diapedesis. Shown, from left to right, are the major steps in diapedesis, the process by which neutrophils and other leukocytes traverse the capillary wall, whose cells are shown in red, in response to chemotactic signals. Cell nuclei are shown in purple and granules in green.

Chemotaxis Is Mediated By G-Protein Coupled Receptors

Leukocytes are attracted into tissues by **chemotactic factors** that include chemokines, complement fragment C5a, small peptides derived from bacteria (eg, *N*-formyl-methionyl-leucyl-phenylalanine), and a number of leukotrienes. The binding of these factors to specific cell-surface receptors activates a signal transduction cascade similar to that which mediates activation of platelets. Both cascades are initiated by ligand binding to receptors containing seven membrane-spanning domains that are closely coupled with heterotrimeric guanosine nucleotide binding proteins (**G proteins**). The G proteins activate **phospholipase C**, which hydrolyses phosphatidylinositol 4,5-bisphosphate to produce **diacylglycerols** and the water soluble second messenger **inositol 1,4,5-triphosphate** (IP₃). The appearance of IP₃ triggers the release of Ca²⁺, leading to a transient increase in the level of cytoplasmic Ca²⁺. In neutrophils, the appearance of cytoplasmic Ca²⁺ activates the components of the actin–myosin cytoskeleton responsible for effecting cell migration and granule secretion. Diacylglycerol, together with Ca²⁺, stimulates protein kinase C and induces its translocation from the cytosol to the plasma membrane, where it catalyzes the **phosphorylation** of various proteins, including some involved in the triggering the respiratory burst (see below).

Chemokines Are Stabilized by Disulfide Bonds

Chemokines are small, generally 6 to 10 kDa, proteins secreted by activated white blood cells that attract additional leukocytes to a site of infection or injury. Chemokines can be divided into

four subclasses based on the number and spacing of the cysteine residues that participate in the formation of the disulfide bonds that stabilize the protein's conformation (**Figure 54–3**). Type C chemokines are characterized by the presence of a pair of conserved cysteine residues that form an intrachain disulfide bond. In addition to the conserved disulfide bond present in type C, the other three recognized chemokine groups possess a second disulfide bond. In type CC chemokines, one of the additional cysteine residues lies adjacent to the first of the first pair of universally conserved residues. In types CXC and CX₃C, these cysteines are separated by one and three intervening amino acid residues, respectively. CX₃C chemokines, the largest of the four types of cytokines, have a longer C-terminus that includes sites of covalent modification by glycosylation.

Integrins Facilitate Diapedesis

The adhesion of leukocytes to vascular endothelial cells is mediated by transmembrane glycoproteins of the **integrin** and **selectin** families (see the discussion of **selectins** in Chapter 46). **Integrins** consist of an α and a β subunit linked noncovalently. Each subunit contains extracellular, transmembrane, and intracellular segments. The extracellular segments bind to various cell surface proteins that possess Arg-Gly-Asp sequences (eg, several components of the extracellular matrix). The intracellular domains bind to various proteins of the cytoskeleton, such as actin and vinculin. Integrins help to integrate leukocyte responses (eg, movement and phagocytosis) to changes in the environment by virtue of their ability to link the outsides of cells to their insides via their dual binding domains. Some integrins of specific interest with regard to neutrophils are listed in **Table 54–1**.

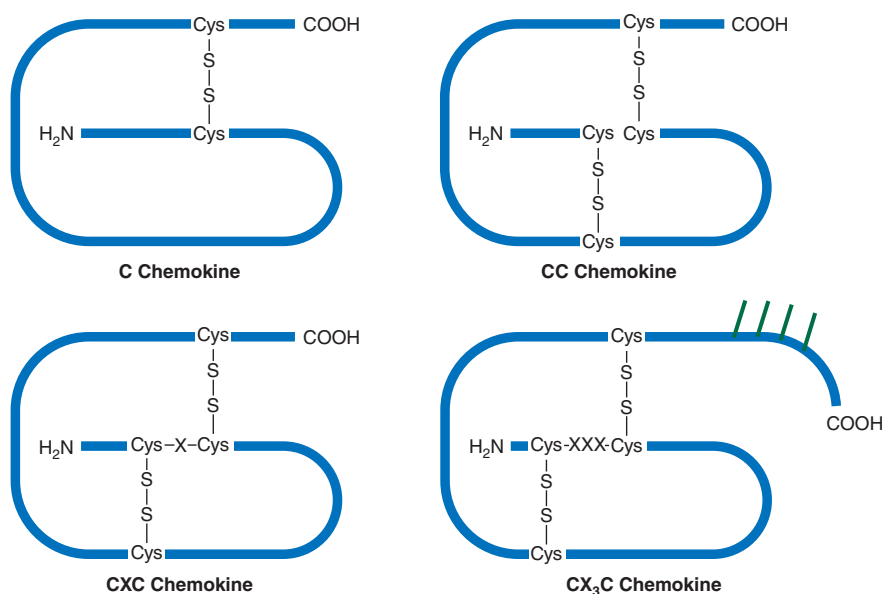

FIGURE 54–3 Chemokines. This figure depicts the key structural features of type C, CC, CXC, and CX₃C chemokines. The polypeptide chains are depicted in blue with their amino and carboxy termini marked by H₂N and COOH, respectively. Key cysteine residues are denoted as Cys, conserved disulfide bonds at S-S, and spacer amino acids for types CXC and CX₃C using X. Bound carbohydrate is depicted in green.

TABLE 54-1 Principal Integrins of White Blood Cells and of Platelets^a

Integrin	Cell	Subunit	Ligand	Function
VLA-1 (CD49a)	WBCs, others	$\alpha 1\beta 1$	Collagen, laminin	Cell-ECM adhesion
VLA-5 (CD49e)	WBCs, others	$\alpha 5\beta 1$	Fibronectin	Cell-ECM adhesion
VLA-6 (CD49f)	WBCs, others	$\alpha 6\beta 1$	Laminin	Cell-ECM adhesion
LFA-1 (CD11a)	WBCs	$\alpha L\beta 2$	ICAM-1	Adhesion of WBCs
Glycoprotein IIb/IIIa	Platelets	$\alpha IIb\beta 3$	ICAM-2	
Fibrinogen, fibronectin, von Willebrand factor	Platelet adhesion and aggregation			

^aCD, cluster of differentiation; ECM, extracellular matrix; ICAM, intercellular adhesion molecule; LFA-1, lymphocyte function-associated antigen 1; VLA, very late antigen.

Note: A deficiency of LFA-1 and related integrins is found in type I leukocyte adhesion deficiency (OMIM 116920). A deficiency of platelet glycoprotein IIb/IIIa complex is found in Glanzmann thrombasthenia (OMIM 273800), a condition characterized by a history of bleeding, a normal platelet count, and abnormal clot retraction. These findings illustrate how fundamental knowledge of cell surface adhesion proteins is shedding light on the causation of a number of diseases.

Type 1 leukocyte adhesion deficiency is caused by a lack of the β_2 subunit (also designated CD18) of LFA-1 and of two related integrins found in neutrophils and macrophages, Mac-1 (CD11b/CD18) and p150,95 (CD11c/CD18). The loss of these proteins impairs the ability of the affected leukocytes to adhere to endothelial cells, the first step in diapedesis. Since fewer white blood cells enter their infected tissues, affected individuals tend to suffer from recurrent bacterial and fungal infections.

INVADING MICROBES AND INFECTED CELLS ARE DISPOSED BY PHAGOCYTOSIS

Phagocytes Ingest Target Cells

A key mechanism by which white blood cells destroy invading microorganisms is **phagocytosis** (Figure 54-4). Phagocytic leukocytes recognize and bind target cells using receptors that recognize either endogenous surface groups, such as bacterial lipopolysaccharides, or peptidoglycans. In most cases, however, infective pathogens are recognized indirectly, by the presence of antibodies or complement factors that have previously adhered to their surface (see Chapter 52). The process of tagging an invader with protective proteins to facilitate recognition by phagocytic leukocytes is called **opsonization**.

Receptor binding triggers dramatic alterations in the shape of the phagocyte, which proceeds to envelop the target cell until it is encased within an internalized membrane vesicle called a **phagosome** (phagolysosome). The internalized cell is then destroyed using a combination of hydrolytic enzymes (eg, lysozyme, proteases), antimicrobial peptides (defensins), and reactive oxygen species. The enzymes and toxins responsible for the lysis of the enveloped cell and breakdown of its macromolecular components (Table 54-2) are stored in cytoplasmic vesicles that fuse with the phagosome. These vesicles are often-times referred to as **granules**, and the cells that harbor them as **granulocytes**, on the basis of their appearance when examined under a microscope. Eventually, the phagosome migrates to the plasma membrane of the white blood cell, where it fuses and expels the remaining debris.

The components of this debris, which include fragments of proteins, oligosaccharides, lipopolysaccharides, peptidoglycans, and polynucleotides, provide an important source of antigens for stimulating the production of new antibodies. Lymphocytes and other white blood cells absorb these materials via endocytosis (see Figure 40-21). The phagocyte often will absorb some of the debris from the phagosome and route it to the cell surface in association with a membrane protein

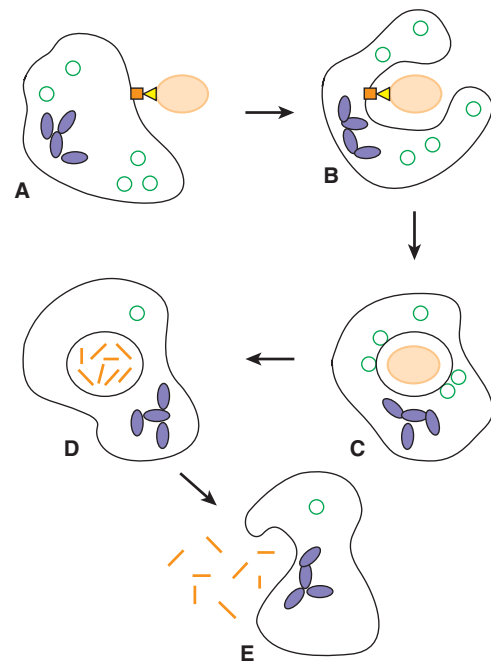

FIGURE 54-4 Phagocytosis. This figure depicts the destruction of an opsonized microorganism, shaded in ORANGE, by a neutrophil via phagocytosis. The multilobed nucleus of the neutrophil is shown in purple, secretory granules in green. The presence of an antibody or complement tag is indicated by a yellow triangle, with the corresponding cell surface receptor as a bright orange square. Cellular debris from the microorganism is represented as orange line segments. (A) The neutrophil binds an antigen molecule on the opsonized microbe via a receptor. (B) The neutrophil envelops the microbe. (C) Secretory granules fuse with the newly internalized phagosome, delivering their contents. (D) Granule-derived enzymes and cytotoxins destroy the microorganism. (E) The phagosome then fuses with the cell membrane, expelling any remaining debris.

TABLE 54-2 Enzymes and Proteins of the Granules of Phagocytic Leukocytes

Enzyme or Protein	Reaction Catalyzed or Function	Comment
Myeloperoxidase (MPO)	$H_2O_2 + X^- (\text{halide}) + H^+ \rightarrow HOX + H_2O$ where $X^- = Cl^-$, HOX = hypochlorous acid	Responsible for the green color of pus Genetic deficiency can cause recurrent infections
NADPH oxidase	$2O_2 + NADPH \rightarrow 2O_2^{\cdot -} + NADP + H^+$	Key component of the respiratory burst Deficient in chronic granulomatous disease
Lysozyme	Hydrolyzes link between N-acetylmuramic acid and N-acetyl-D-glucosamine found in certain bacterial cell walls	Abundant in macrophages. Hydrolyzes bacterial peptidoglycans
Defensins	Basic antibiotic peptides of 20-33 amino acids	Apparently kill bacteria by causing membrane damage
Lactoferrin	Iron-binding protein	May inhibit growth of certain bacteria by binding iron and may be involved in regulation of proliferation of myeloid cells
Elastase Collagenase Gelatinase Cathepsin G	Proteases	Abundant in phagocytes; Breakdown protein components of infectious organisms; Generate fragments for antigen presentation

called the **major histocompatibility complex (MHC)**. The MHC serves as a scaffold for presenting potential antigens to surrounding lymphocytes in a form that stimulates the production of new antibodies.

The three principal classes of phagocytic leukocytes are **neutrophils**, **eosinophils**, and **macrophages**. Neutrophils, which comprise roughly 60% of the white blood cells present in the circulation, phagocytize bacteria and small eukaryotic microorganisms such as fungi. The less numerous **eosinophils**, which make up 2% to 3% of the leukocytes in the blood, ingest larger eukaryotic microorganisms such as **paramecia**. Macrophages are derived from monocytes, which comprise about 5% of the leukocytes in the blood. Monocytes migrate from the bloodstream into tissues throughout the body where, upon receipt of a stimulus, they differentiate to form **macrophages**. While macrophages also can ingest invading microbes, the signature function of these large phagocytes is to remove human host cells that have been compromised by infection, malignant transformation, or programmed cell death, also known as **apoptosis**. These functionally compromised cells are recognized by the appearance of aberrant proteins and oligosaccharides on their surface. Precocious activation of macrophages is associated with the etiology of many degenerative diseases such as osteoporosis, atherosclerosis, arthritis, and cystic fibrosis, and can facilitate the metastasis of cancer cells.

Phagocytic Leukocytes Generate Reactive Oxygen Species During the Respiratory Burst

Reactive oxygen species (ROS) such as $O_2^{\cdot -}$, H_2O_2 , OH^{\cdot} , and HOCl (hypochlorous acid) form a major component of the chemical and enzymatic arsenal employed by phagocytes

to destroy ingested cells. Production of the various reactive oxygen derivatives takes place shortly (15-60 seconds) after internalization of an encapsulated cell, using O_2 and electrons derived from NADPH. The accompanying surge in oxygen consumption has been termed the **respiratory burst**. The production of large quantities of NADPH is facilitated by the heavy reliance of phagocytes, which contain relatively few mitochondria, on aerobic glycolysis to generate ATP. The consequent need to maintain robust supplies of glycolytic precursors and intermediates ensures the availability of the glucose 6-phosphate required to reduce $NADP^+$ to NADPH via the pentose phosphate pathway (see Chapter 20).

The formation of microbicidal reactive oxygen derivatives during the respiratory burst starts with the synthesis of superoxide, which is catalyzed by the **NADPH oxidase system**. Catalysis proceeds via a two-step mechanism. The first step is the reduction of molecular oxygen to form superoxide (Table 54-2):

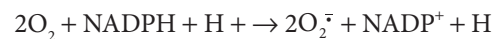

This is followed by the spontaneous dismutation of **hydrogen peroxide** from two molecules of superoxide:



The NADPH oxidase system is comprised of **cytochrome b_{558}** , a plasma membrane-associated heterodimer containing polypeptides of 91 kDa and 22 kDa, and two cytoplasmic peptides of 47 kDa and 67 kDa. Upon activation, the cytoplasmic peptides are recruited to the plasma membrane where they associate with cytochrome b_{558} to form the active complex. The NADPH is generated by the pentose phosphate cycle, whose activity also increases markedly during phagocytosis. Any superoxide from the phagosomes that enters the cytosol

is converted to H_2O_2 by **superoxide dismutase**, which catalyzes the same reaction as the spontaneous dismutation shown above. In turn, H_2O_2 is used by myeloperoxidase (see below) or disposed of by the action of glutathione peroxidase or catalase.

Myeloperoxidase Catalyzes the Production of Chlorinated Oxidants

The formation of hypohalous acids during the respiratory burst is catalyzed by the enzyme **myeloperoxidase**.

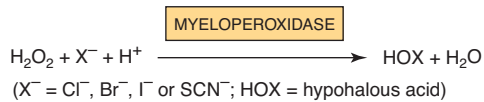

Present in large amounts in neutrophil granules, this enzyme uses H_2O_2 and to oxidize Cl^- and other halides to produce hypohalous acids such as **HOCl**. HOCl, the active ingredient of household liquid bleach, is a powerful oxidant that is highly microbicidal. When applied to normal tissues, its potential for causing damage is diminished because it reacts with primary or secondary amines present in neutrophils and tissues to produce various nitrogen-chlorine derivatives. While also oxidants, these **chloramines** are less powerful than HOCl, and therefore can act as microbicidal agents (eg, in sterilizing wounds) without causing tissue damage.

Mutations Affecting the NADPH Oxidase System Cause Chronic Granulomatous Disease

Functionally deleterious mutations in the genes encoding any of the four polypeptides of the NADPH oxidase system can cause **chronic granulomatous disease**. The resulting decrease in the production of reactive oxygen derivatives undermine the ability of neutrophils and other phagocytic leukocytes to kill bacteria and other infectious microbes. Persons suffering from this relatively uncommon condition experience recurrent infections. They also form granulomas (chronic inflammatory lesions) in the skin, lungs, and lymph nodes to wall off invading pathogens. In some cases, relief can be provided by the administration of gamma interferon, which may increase transcription of the 91-kDa component of cytochrome b_{558} .

NEUTROPHILS AND EOSINOPHILS EMPLOY NETS TO ENTRAP PARASITES

In addition to ingesting small microorganisms such as bacteria by phagocytosis, neutrophils and eosinophils can assist in the elimination of larger invaders by trapping them within webs called **neutrophil extracellular traps** or NETs (Figure 54–5). The dispersal, or **decondensation**, of a neutrophil's chromosome provides extended polynucleotide strands that serve as the core of a NET. This process involves rupture of the nuclear membrane and the disruption of favorable charge-charge

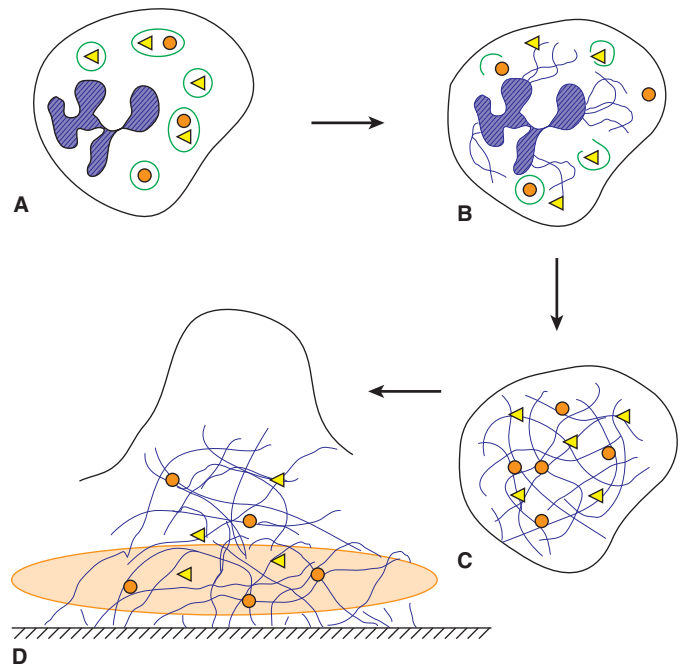

FIGURE 54–5 Trapping parasites using NETs. The figure depicts the basic stages in the formation and deployment of a DNA-based web by a neutrophil or eosinophil to trap a parasitic microorganism. (A) Resting neutrophil. The multilobed nucleus is shown in hatched purple, intracellular granules in green, and granule enzymes and cytotoxins as orange circles and yellow triangles. (B) Upon stimulation, the membranes encasing the nucleus and granules rupture, releasing enzymes, cytotoxins, and strands of DNA (purple) from decondensing chromosomes. (C) The DNA strands form a mesh that fills the interior of the cell to which some granule-derived proteins adhere. (D) The neutrophil lyses, releasing its DNA-protein web, which entraps the parasite (orange) against surface of the epithelium (hatched).

interactions that stabilize chromatin's compact structure. Dissolution of histone-polynucleotide complexes is promoted by the enzymatic deimination of the side chains of arginine residues, which are protonated at physiological pH, to form citrulline residues, whose side chains are neutral, by **peptidyl-arginine deiminase** (Figure 54–6). Some chromatin proteins remain associated with the DNA, providing crosslinks between the polynucleotide strands. Granule membranes also rupture at this time, releasing their contents into the cytoplasm where they

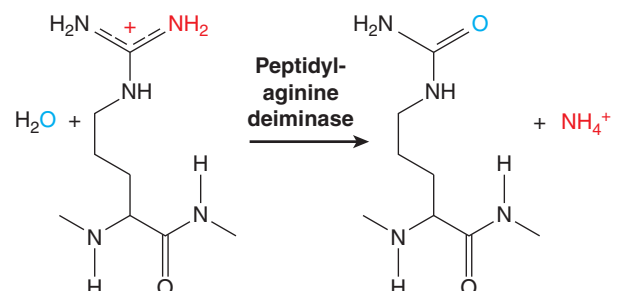

FIGURE 54–6 Citrullination. The enzyme peptidyl arginine deiminase displaces one of the imino groups (red) on the side chain of arginine by an oxygen atom (blue) derived from water. The net result is to replace a positive charge provided by the protonated arginine side chain by an amide, which is neutral.

can bind to dispersing polynucleotide strands, decorating the DNA with granule-derived proteases, antimicrobial peptides, and other factors. Finally, the neutrophils lyse to unleash their NETs upon invading parasites, immobilizing them, hindering their spread and aiding in their elimination.

PHAGOCYTE-DERIVED PROTEASES CAN DAMAGE HEALTHY CELLS

Macrophages other phagocytes produce numerous proteinases (Table 54–2), several of which can hydrolyze elastin, various types of collagen, and other proteins present in the extracellular matrix. If allowed to proceed unopposed this can result in serious damage to tissues. Although small amounts of elastase and other proteinases leak out into normal tissues, their activities are normally kept in check by a number of **antiproteinases** present in plasma and the extracellular fluid (see Chapter 52). Antiproteinases like circulating α_2 -**macroglobulin** act by forming a noncovalent complex with one or more specific proteinases, inhibiting their activity. A genetic defect that permits elastase to act unopposed by α_1 -**antiproteinase inhibitor** (α_1 -antitrypsin) on pulmonary tissue contributes significantly to the causation of emphysema.

Elevated levels of chlorinated oxidants formed during inflammation can tilt the balance between proteinases and antiproteinases in favor of the former. For instance, some of the proteinases listed in Table 54–2 are **activated** by HOCl, whereas by contrast certain antiproteinases are **inactivated** by HOCl. In addition, the tissue inhibitor of metalloproteinases and α_1 -antichymotrypsin can be hydrolyzed by activated elastase, and α_1 -antiproteinase inhibitor can be hydrolyzed by activated collagenase and gelatinase. While an **appropriate balance** of proteinases and antiproteinases is generally maintained, in certain instances, such as in the lung when α_1 -antiproteinase inhibitor is deficient or when large amounts of neutrophils accumulate in tissues because of inadequate drainage, considerable **tissue damage** can result.

LEUKOCYTES COMMUNICATE USING SECRETED EFFECTORS

The development of an immune response and accompanying inflammation of injured or infected tissues requires the coordinated action of leukocytes and other cells. Activation of neighboring leukocytes and recruitment of additional white blood cells to a site of injury or infection is mediated by secreted effector molecules, including cytokines, leukotrienes, and histamine. In most instances, these effectors are stored within intracellular membrane vesicles that, upon stimulation, migrate to and fuse with the plasma membrane in order to expel, or **secrete**, their contents. The term **granulocyte** refers to those leukocytes, such as basophils, eosinophils, and leukocytes, whose secretory vesicles are sufficiently large, numerous,

and dense to impart a distinctly granular appearance to the interior of these cells when viewed through a microscope.

The term **cytokine** refers to a diverse set of small, generally less than 25 kDa in mass, secreted proteins that include the **interleukins**, **interferons**, and **chemokines**. The interleukins, of which more than three dozen have been characterized, derive their name from cells in which they are synthesized and from which they are secreted. They are generally designated by the class abbreviation **IL** followed by an identifying number, eg, IL1, IL3, IL22. The interferons (**IFN**), on the other hand, derive their name from their ability to inhibit, or interfere, with the replication of infecting viruses. Approximately 10 distinct families of interferons have been identified in animals to date. The characteristic function of chemokines is to serve as chemical attractants that stimulate leukocytes to migrate toward their source (**chemotaxis**). Most cytokines are glycosylated. In general, they stimulate both the leukocytes from which they are secreted (**autocrine signaling**) as well as other types of leukocytes (**paracrine signaling**). Historically, cytokines have been distinguished from hormones by their association immunity and inflammation.

Leukocytes also secrete lipid mediators, called **eicosanoids**, produced by the oxidation of arachidonic acid (see Chapter 15). These lipid mediators fall into two broad classes, **leukotrienes** and **prostaglandins**. Leukotrienes are characterized by the presence of a set of three conjugated carbon-carbon double bonds. Several of the leukotrienes incorporate the amino acid cysteine into their structure. Prostaglandins, which were first isolated from the prostate gland, contain 20 carbon atoms and are distinguished by the presence of five-membered ring.

Histamine (Figure 54–1), which is synthesized by decarboxylating the amino acid histidine, is a mediator that is secreted in large amounts by **basophils** and **mast cells**. Histamine works with other hematologic factors, such as heparin and eicosanoids, to maintain blood flow to the area and stimulate the accumulation of plasma derived from the blood in infected and injured tissue. The resulting fluid accumulation (edema) constitutes a key component of the inflammatory response that accompanies activation of the immune system as it greatly facilitates the migration of additional leukocytes to the affected area in response to chemotactic mediators.

LYMPHOCYTES PRODUCE PROTECTIVE ANTIBODIES

Lymphocytes make up approximately 30% of the leukocytes present in the blood. By virtue of their capacity to novel produce protective antibodies optimized to bind newly encountered antigens (see Chapter 53), lymphocytes form the cornerstone of the body's **adaptive immune system**. The classification of lymphocytes into B and T types originally was based on the identity of the tissues in which each form completed their maturation. In avian species, the B lymphocytes (B cells) are processed in the **Bursa of Fabricius**. The B cells

in humans, which lack this organ, mature in the **bone marrow**. Maturation of **T lymphocytes (T cells)** takes place in the **thymus**. The soluble antibodies present in bodily humors, eg, plasma and interstitial fluids, are secreted by B lymphocytes. For this reason, B cells are said to confer **humoral immunity**.

Lymphocytes that have yet to be stimulated to produce immunoglobulins are said to be **naïve**. Synthesis of a new antibody can be triggered by several mechanisms. Lymphocytes can bind directly to foreign invaders via one of the many receptors present on their surface, which include proteins configured to bind bacterial glycoproteins, lipopolysaccharide, or peptidoglycan. Alternatively, the lymphocyte can be activated when encountering an antigen that has been displayed or presented on the surface of another white blood cell in association with the major histocompatibility complex. Macrophages, neutrophils, and phagocytic lymphocytes called **plasma cells** display or present fragments of macromolecules they have destroyed by phagocytosis. **Helper T cells** ingest (by endocytosis) and present antigens on their surface, including debris ejected by phagocytes. **Helper T-cells** serve as “cellular switchboards,” coordinating the immune response by receiving, processing, and sending signals from and to other components of the immune system.

Cytotoxic T cells recognize proteins that appear on the surface of host cells as a consequence of viral infection or oncogenic transformation. Once bound, they induce the lysis of the target cell using proteins called perforins, which form channels in the plasma membrane, and proteases called granzymes. Granzymes mimic the action of the endogenous cathepsin proteases that trigger programmed cell death (**apoptosis**). **Natural killer cells** resemble cytotoxic T-cells, but contain granules holding additional toxic chemicals to aid in their attack.

SUMMARY

- The elimination of infectious microorganisms involves the cumulative actions of multiple types of leukocytes, including lymphocytes, phagocytes, and basophils.
- White blood cells communicate using secreted effector molecules such as chemokines, prostaglandins, leukotrienes, interleukins, and interferons.
- Leukocytes migrate from the blood to the tissues in response to specific chemical attractants, a process termed chemotaxis.
- The amoeboid motion and diapedesis of leukocytes relies on cytoskeletally mediated cell flexibility and deformation.
- Basophils secrete histamine and heparin, which facilitate the migration of leukocytes by inducing fluid accumulation at a site of infection or injury.

- Integrins mediate the adhesion of white blood cells to the vascular endothelium, the first step in migration toward infected tissues.
- Phagocytes internalize invading microorganisms inside membrane vesicles called phagosomes.
- Destruction of phagocytized microorganisms is accomplished using a combination of reactive oxygen species (the respiratory burst), hydrolytic enzymes, and cytotoxic peptides.
- Mutations in proteins of the NADPH oxidase system cause chronic granulomatous disease.
- Neutrophils and eosinophils inhibit large parasites by immobilizing them within webs formed primarily from their chromosomal DNA.
- Decondensation of chromosomal DNA is facilitated by citrullination of arginine side chains of histones.
- Lymphocytes produce protective immunoglobulins (antibodies).
- Phagocytes and helper T cells stimulate the production of new antibodies by presenting fragments of pathogen-derived macromolecules in association with a membrane protein called the major histocompatibility complex.
- Cytotoxic T cells and natural killer cells recognize and destroy host cells that display cell surface proteins characteristic of viral infection or malignant transformation.

REFERENCES

- Adkis M, Burgler S, Cramer R, et al: Interleukins, from 1 to 37, and interferon- γ : receptors, functions, and roles in diseases. *J Allergy Clin Immunol* 2011;127:701.
- Fauci AS, Braunwald E, Kasper DL, et al (editors): *Harrison's Principles of Internal Medicine*, 17th ed. McGraw-Hill, 2008. (Chapters 58, 61, & 98-108 deal with various blood disorders. Chapters 66-68 deal with various aspects of hematopoietic and other stem cells.)
- Mayadas TN, Cullere X, Lowell CA: The multifaceted functions of neutrophils. *Annu Rev Pathol* 2014;9:181.
- Nordenfelt P, Tapper H: Phagosome dynamics during phagocytosis by neutrophils. *J Leukocyte Biol* 2011;90:271. van den Berg JM, van Koppen E, Ahlin A, et al: Chronic granulomatous disease: the European experience. *PLoS ONE* 2009;4:e5234.
- Whichard ZL, Sarkar CA, Kimmel M, Corey SJ: Hematopoiesis and its disorders: a systems biology approach. *Blood* 2010;115:2339.
- Wynn TA, Chawla A, Pollard JW: Macrophage development in development, homeostasis and disease. *Nature* 2013;496:445.
- Yonekawa K, Harlan JM: Targeting leukocyte integrins in human diseases. *J Leukoc Biol* 2005;77:129.

Exam Questions

Section X - Special Topics (B)

- Briefly describe the mode of action of nitroglycerin, a common agent for treating angina.
- Patients being treated for heart failure oftentimes exhibit decreased expression and defective regulation of SERCA2a, the principle Ca^{2+} -ATPase of the sarcoplasmic reticulum. Explain how defects in this protein might contribute to deterioration in cardiac function.
- List one point of similarity and one point of difference between the mode of action of myosin light chain kinase in smooth versus striated muscle.
- A patient anesthetized using a halothane compound exhibits a marked rise in body temperature, a behavior indicative of malignant hyperthermia (MH). Select the one of the following statements that is NOT CORRECT:
 - MH can arise from mutations that alter the amino acid sequence of the Na^+ - K^+ -ATPase.
 - MH can arise from mutations that alter the amino acid sequence of the ryanodine-sensitive Ca^{2+} release channel.
 - The muscle rigidity that occurs during MH is triggered by the presence of high concentrations of Ca^{2+} in the cytoplasm.
 - MH can arise from mutations that alter the amino acid sequence of the voltage-gated, slow K type Ca^{2+} channel.
 - MH can be treated by intravenous administration of dantrolene, which inhibits release of Ca^{2+} from the sarcoplasmic reticulum into the cytosol.
- Select the one of the following statements that is NOT CORRECT:
 - F-actin is formed by the polymerization of G-actin.
 - Myosin is the major component of the thick filaments found in striated muscle.
 - Thin filaments are connected together by α -actinin.
 - The troponin system regulates the contraction of smooth muscle.
 - Ca^{2+} serves as a second messenger for regulating contraction in smooth, cardiac, and skeletal muscle.
- Select the one of the following that is NOT a feature of the contractile cycle in striated muscle:
 - Binding of Ca^{2+} to troponin C uncovers the myosin binding sites on actin.
 - The power stroke is initiated by the release of P_i from the actin-myosin-ADP- P_i complex.
 - Release of ADP from the actin-myosin-ADP complex is accompanied by a large change in the conformation of myosin's head domain (relative to its tail domain).
 - The binding of ATP by myosin increases its affinity for actin.
 - Rigor mortis results for the inability of actin to release from the actin myosin complex when cells are deficient in ATP.
- Select the one of the following that does NOT serve as a major energy reserve for replenishing ATP in muscle tissue:
 - Glycogen
 - Creatine phosphate
 - ADP (in conjunction with adenylyl kinase)
 - Fatty acids
 - Epinephrine
- Select the one of the following statements that is NOT CORRECT:
 - The drugs colchicine and vinblastine inhibit microtubule assembly.
 - Mutations affecting keratin can lead to blistering.
 - Mutations in the gene encoding lamin A and lamin C cause progeria (accelerated aging).
 - α - and β -tubulin are the major components of stress fibers.
 - Molecular motors such as dynein, kinesin, and dynamin power ciliary movement, vesicle transport, and endocytosis.
- Briefly explain the connection between liver disease and chronic edema.
- Describe the role of haptoglobin in the protection of the kidneys from the potentially damaging effects of extracorporeal hemoglobin.
- Briefly describe how activation of cytidine deaminase helps generate immunoglobulins with unique antigen binding sites.
- Select the one of the following statements that is NOT CORRECT:
 - Interleukin-1 stimulates the production of acute-phase proteins.
 - Iron must be reduced to the ferrous (Fe^{2+}) state in order to be recovered via the transferrin cycle.
 - Many complement proteins are zymogens.
 - The type 2 transferrin receptor (TfR2) functions primarily as an iron sensor.
 - Mannose-binding lectin binds carbohydrate groups present on the surface of invading bacteria.
- Select the one of the following statements that is NOT CORRECT:
 - Albumin is synthesized as a proprotein.
 - Albumin is stabilized by multiple intrachain disulfide bonds.
 - Albumin is a glycoprotein.
 - Albumin facilitates the movement of fatty acids through the circulation.
 - Albumin is the major determinant of plasma osmotic pressure.
- Select the one of the following statements that is NOT CORRECT:
 - Wilson disease can be treated using copper chelators such as penicillamine.
 - Wilson disease is characterized by copper toxicosis (abnormally high levels of copper).
 - Wilson disease is caused by mutations in the gene encoding ceruloplasmin.
 - Albumin facilitates the movement of sulfonamide drugs through the circulation.
 - Albumin can be lost from the body if the intestinal mucosa becomes inflamed.

15. You encounter a 50-year-old woman in the clinic who is pale and tired. You suspect that she is suffering from iron deficiency anemia and prescribe a series of laboratory tests. Select the one of the following potential test outcomes that would NOT be consistent with your provisional diagnosis:
- Lower than normal levels of red cell protoporphyrin
 - Increased saturation of transferrin
 - Increased expression of TfR
 - Increased levels of plasma hepcidin
 - Decreased levels of hemoglobin
16. Select the one of the following that is NOT a potential cause of amyloidosis:
- Accumulation of β_2 -macroglobulin
 - Deposition of fragments derived from immunoglobulin light chains
 - Accumulation of degradation products of serum amyloid A
 - Presence of mutationally altered forms of transthyretin
 - Amylase deficiency
17. Select the one of the following statements that is NOT CORRECT:
- All immunoglobulins contain at least two heavy chain polypeptides and two light chain polypeptides.
 - Immunoglobulin polypeptide chains are linked together by disulfide bonds.
 - Immunoglobulins are multivalent.
 - Immunoglobulins are glycosylated.
 - Immunoglobulins are primary components of the body's innate immune system.
18. Explain the linkage how a deficiency in glucose-6-phosphate dehydrogenase within erythrocytes can lead to hemolytic anemia.
19. Select the one of the following statements that is NOT CORRECT:
- The high surface area of biconcave red blood cells facilitates gas exchange.
 - Hereditary elliptocytosis can be caused by defects in or a deficiency of spectrin.
 - The diameter of red blood cells exceeds that of many peripheral capillaries.
 - Protein 4.1 helps link the erythrocyte cytoskeleton to proteins in the cell's plasma membrane.
 - In order to pass through narrow capillaries, red blood cells must be squeezed into a compact, spherical shape.
20. Select the one of the following statements that is NOT CORRECT:
- Red blood cells contain high levels of superoxide dismutase.
 - A and B substance are formed by the addition of fucose and *N*-acetyl glucosamine, respectively, to H substance.
 - Platelets generate ATP exclusively via glycolysis.
 - Mature red blood cells are devoid of internal organelles.
 - Erythrocyte membranes contain high levels of the Band 3 anion exchange protein.
21. Select the one of the following statements that is NOT CORRECT:
- Erythropoietin stimulates the formation of red blood cells from haematopoietic stem cells.
 - Multipotent stem cells are able to differentiate into cells of a closely related type.
 - Carbonic anhydrase increases the capacity of red blood cells to transport CO_2 .
 - GLUT1 mediates the active transport of glucose into erythrocytes.
 - Hypoxia stimulates the production of erythropoietin by the kidneys.
22. A patient recently exposed to aniline displays bluish discoloration of their skin and mucous membranes. Select a plausible provisional diagnosis from the list below:
- Methemoglobinemia
 - Hereditary hemochromatosis
 - 5q-syndrome
 - Immune thrombocytopenic purpura
 - Glanzmann thrombasthenia
23. Select the one of the following statements that is NOT CORRECT:
- Leukocyte chemotaxis is mediated by G-protein coupled receptors.
 - The ability of the cytoskeleton to dramatically manipulate the morphology of white blood cells is critical to chemotaxis, phagocytosis, and secretion.
 - Leukocytes secrete proteases to generate openings between vascular endothelial cells during diapedesis.
 - The accumulation of fluid at a site of infection facilitates leukocyte migration.
 - Leukocyte adhesion deficiency is caused by a failure to express integrin polypeptides.
24. Select the one of the following statements that is NOT CORRECT:
- Interleukins are key mediators of leukocyte production.
 - Lymphocytes produce protective antibodies.
 - Monocytes can be found in tissues throughout the body.
 - The hematologic factor histamine is synthesized by the deamination of the amino acid histidine.
 - The term polymorphonuclear refers to leukocytes possessing a segmented nucleus.
25. Select the one of the following statements that is NOT CORRECT:
- Phagocytes destroy ingested bacteria using reactive oxygen species and hydrolytic enzymes.
 - Chronic granulomatous disease is caused by a deficiency in myeloperoxidase activity.
 - NADPH serves as the primary source of electrons for generating ROS during the oxidative burst.
 - Neutrophils aid in the elimination of some parasites by enmeshing them in NETs formed from their chromosomal DNA.
 - Chemokines are stabilized by the formation of intrachain disulfide bonds.
26. Select the one of the following statements that is NOT CORRECT:
- Activated leukocytes secrete lipid mediators called interferons.
 - Neutrophils facilitate production of protective antibodies by presenting fragments of phagocytized microbes on their surface in association with the major histocompatibility complex (MHC).

- C. Cytotoxic T cells use perforins to lyse infected cells.
 D. Soluble antibodies are released into the plasma primarily by B lymphocytes.
 E. Emphysema can arise from the action of elastase and other granule-derived proteases on pulmonary tissue.
27. Select the one FALSE statement:
 A. The great majority of mitochondrial proteins are encoded by the nuclear genome.
 B. Ran proteins, like ARF and Ras proteins, are monomeric GTPases.
 C. One cause of Refsum disease is mutations in genes encoding peroxisomal proteins.
 D. Peroxisomal proteins are synthesized on cytosolic polyribosomes.
 E. Import of proteins into mitochondria involves proteins known as importins.
28. Select the one FALSE statement:
 A. *N*-terminal signal peptides directing nascent proteins to the ER membrane contain a hydrophobic sequence.
 B. Post-translational translocation of proteins to the ER does not occur in mammalian species.
 C. The SRP contains one RNA species.
 D. *N*-glycosylation is catalyzed by oligosaccharyl transferase.
 E. Type I membrane proteins have their *N*-termini facing the lumen of the ER.
29. Select the one FALSE statement:
 A. Chaperones often exhibit ATPase activity.
 B. Protein disulfide isomerase and peptidyl prolyl isomerase are enzymes involved in helping proteins fold properly.
 C. Ubiquitin is a small protein involved in protein degradation by lysosomes.
 D. Mitochondria contain chaperones.
 E. Retrotranslocation across the ER membrane is involved in helping dispose of misfolded proteins.
30. Select the one FALSE statement:
 A. Rab is a small GTPase involved in vesicle targeting.
 B. COPII vesicles are involved in anterograde transport of cargo from the ER to the ERGIC or Golgi apparatus.
 C. Brefeldin A prevents GTP binding to ARF, and thus inhibits formation of COP I vesicles.
 D. Botulinum toxin B acts by cleaving synaptobrevin, inhibiting release of acetylcholine at the neuromuscular junction.
 E. Furin converts proalbumin to albumin.
31. Which one of the following types of protein does NOT act as a GTPase?
 A. ADP ribosylation factor (ARF)
 B. Rab proteins
 C. *N*-ethylmaleimide-sensitive factor (NSF)
 D. Sar1
 E. Ran proteins
32. Select the one FALSE statement:
 A. Collagen has a triple helical structure, forming a right-hand superhelix.
 B. Proline and hydroxyproline confer rigidity on collagen.
 C. Collagen contains one or more *O*-glycosidic linkages.
 D. Collagen lacks cross-links.
 E. Deficiency of vitamin C impairs the action of prolyl and lysyl hydroxylases.
33. Select the one FALSE statement:
 A. Elastin contains hydroxyproline, but not hydroxylysine.
 B. Elastin contains cross-links formed by desmosines.
 C. No genetic diseases due to abnormalities of elastin have as yet been identified.
 D. Unlike collagen, there is only one gene encoding elastin.
 E. Elastin does not contain any sugar molecules.
34. Select the one FALSE statement:
 A. Marfan syndrome is due to mutations in the gene encoding fibrillin-1, a major constituent of microfibrils.
 B. All subtypes of Ehlers–Danlos syndrome are due to mutations affecting the genes encoding the various types of collagen.
 C. Laminin is found in renal glomeruli along with entactin, type IV collagen, and heparin or heparan sulfate.
 D. Mutations affecting type IV collagen can cause serious renal disease.
 E. Mutations in the collagen *IA1* gene can cause osteogenesis imperfecta.
35. Select the one FALSE statement:
 A. Most but not all GAGs contain an amino sugar and a uronic acid.
 B. All GAGs are sulfated.
 C. GAGs are built up by the actions of glycosyltransferases using sugars donated by nucleotide-sugars.
 D. Glucuronic acid can be converted to iduronic acid by an epimerase.
 E. The proteoglycan aggrecan contains hyaluronic acid, keratan sulfate, and chondroitin sulfate.
36. A male infant is failing to thrive and, on examination, is noted to have hepatomegaly and splenomegaly, among other findings. Urinalysis reveals the presence of both dermatan sulfate and heparan sulfate. You suspect the patient has Hurler syndrome. From the following list, select the enzyme that you would wish to have assayed to support your diagnosis:
 A. β -Glucuronidase
 B. β -Galactosidase
 C. α -L-Iduronidase
 D. α -*N*-Acetylglucosaminidase
 E. Neuraminidase
37. You see a child in clinic who is well below average height. You note that the child has short limbs, normal trunk size, macrocephaly, and a variety of other skeletal abnormalities. You suspect that the child has achondroplasia. Select from the following list the test that would best confirm your diagnosis:
 A. Measurement of growth hormone
 B. Assays for enzymes involved in the metabolism of GAGs
 C. Tests for urinary mucopolysaccharides
 D. Gene tests for abnormalities of the fibroblast growth factor receptor 3 (FGFR3)
 E. Gene tests for abnormalities of growth hormone

Hemostasis & Thrombosis

Peter L. Gross, MD, MSc, FRCP(C), Robert K. Murray, MD, PhD,
P. Anthony Weil, PhD & Margaret L. Rand, PhD

OBJECTIVES

*After studying this chapter,
you should be able to:*

- Understand the significance of hemostasis and thrombosis in health and disease.
- Outline the pathways of coagulation that result in the formation of fibrin.
- Identify the vitamin K–dependent coagulation factors.
- Provide examples of genetic disorders that lead to bleeding.
- Describe the process of fibrinolysis.
- Outline the steps leading to platelet aggregation.
- Identify antiplatelet drugs and their mode of inhibition of platelet aggregation.

BIOMEDICAL IMPORTANCE

Basic aspects of the proteins of the blood coagulation system and of fibrinolysis are described in this chapter. Some fundamental aspects of platelet biology are also presented. Hemorrhagic and thrombotic states can cause serious medical emergencies, and thromboses in the coronary and cerebral arteries are major causes of death in many parts of the world. Rational management of these conditions requires a clear understanding of the bases of blood coagulation, fibrinolysis, and platelet activation.

HEMOSTASIS & THROMBOSIS HAVE THREE COMMON PHASES

Hemostasis is the cessation of bleeding from a cut or severed vessel, whereas **thrombosis** occurs when the endothelium lining blood vessels is damaged or removed (eg, upon rupture of an atherosclerotic plaque). These processes involve blood

vessels, platelet aggregation, and plasma proteins that cause formation or dissolution of platelet aggregates and fibrin.

In hemostasis, there is initial vasoconstriction of the injured vessel, causing diminished blood flow distal to the injury. Then, hemostasis and thrombosis share **three phases**:

1. Formation of a loose and temporary **platelet aggregate** at the site of injury. Platelets bind to collagen at the site of vessel wall injury, form thromboxane A_2 , and release ADP, which activate other platelets flowing by the vicinity of the injury. (The mechanism of platelet activation is described below.) Thrombin, formed during coagulation at the same site, causes further platelet activation. Upon activation, platelets change shape and, in the presence of fibrinogen and/or von Willebrand factor, aggregate to form the hemostatic plug (in hemostasis) or thrombus (in thrombosis).
2. Formation of a **fibrin mesh** that binds to the platelet aggregate, forming a more stable hemostatic plug or thrombus.
3. Partial or complete **dissolution** of the hemostatic plug or thrombus by plasmin.

There Are Three Types of Thrombi

Three types of thrombi or clots are distinguished. All three contain **fibrin** in various proportions.

1. The **white thrombus** is composed of platelets and fibrin and is relatively poor in erythrocytes. It forms at the site of an injury or abnormal vessel wall, particularly in areas where blood flow is rapid (arteries).
2. The **red thrombus** consists primarily of red cells and fibrin. It morphologically resembles the clot formed in a test tube and may form *in vivo* in areas of retarded blood flow or stasis (eg, veins) with or without vascular injury, or it may form at a site of injury or in an abnormal vessel in conjunction with an initiating platelet plug.
3. A third type is **fibrin deposits** in very small blood vessels or capillaries.

We shall first describe the coagulation pathway leading to the formation of fibrin. Then, we shall briefly describe some aspects of the involvement of platelets and blood vessel walls in the overall process. This separation of clotting factors and platelets is artificial since both play intimate and often mutually interdependent roles in hemostasis and thrombosis; this strategy facilitates description of the overall processes involved.

Both Extrinsic & Intrinsic Pathways Result in the Formation of Fibrin

Two pathways lead to **fibrin clot** formation: the **extrinsic** and the **intrinsic** pathways. These pathways are not independent, as previously thought. However, this artificial distinction is retained in the following text to facilitate their description.

Initiation of fibrin clot formation in response to **tissue injury** is carried out by the **extrinsic pathway**. The **intrinsic pathway** can be activated by negatively charged surfaces **in vitro**, for example glass. Both pathways lead to the proteolytic conversion of **prothrombin** to **thrombin**. Thrombin catalyzes cleavage of **fibrinogen** to initiate **fibrin** clot formation. The extrinsic and intrinsic pathways are complex and involve many different proteins (Figures 55–1 and 55–2; Table 55–1). The coagulation factors are another example of multidomain proteins sharing conserved domains (see, Figure 5–9). In general, as shown in Table 55–2, these proteins can be classified into **five types**: (1) zymogens of serine-dependent proteases that are activated during the process of coagulation; (2) cofactors; (3) fibrinogen; (4) a transglutaminase that covalently crosslinks fibrin and stabilizes the fibrin clot; and (5) regulatory and other proteins.

The Extrinsic Pathway Leads to Activation of Factor X

The **extrinsic pathway** involves tissue factor, factors VII and X, and Ca^{2+} and results in the production of factor Xa (by convention, activated clotting factors are referred to by use of the suffix a). The extrinsic pathway is initiated at the site of **tissue**

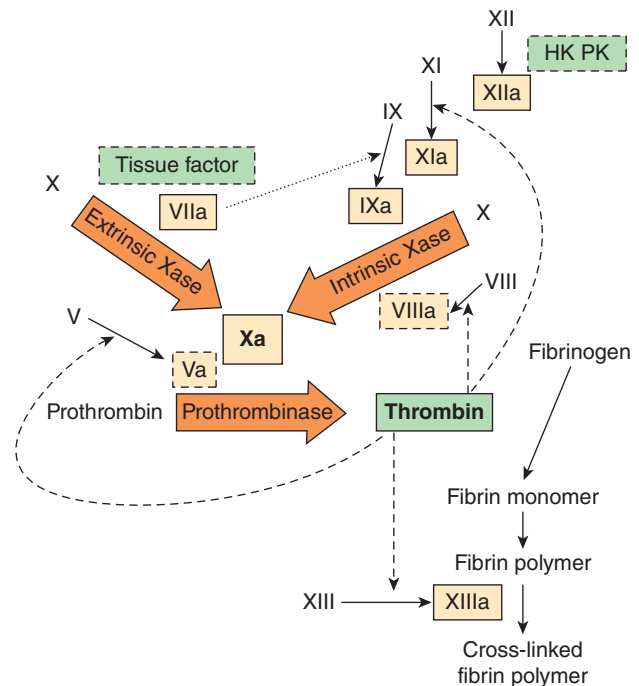

FIGURE 55–1 The pathways of blood coagulation, with the **extrinsic pathway indicated at the top left and the intrinsic pathway at the top right**. The pathways converge in the formation of factor Xa and culminate in the formation of cross-linked fibrin. Complexes of tissue factor and factor VIIa activate not only factor X (extrinsic Xase [tenase]) but also factor IX in the intrinsic pathway (dotted arrow). In addition, thrombin feedback activates at the sites indicated (dashed arrows) and also activates factor VII to factor VIIa (not shown). The three predominant complexes, extrinsic Xase, intrinsic Xase, and prothrombinase, are indicated in the arrows; these reactions require anionic procoagulant phospholipid membrane and calcium. Activated proteases are in solid-outlined boxes; active cofactors are in dash-outlined boxes and inactive factors are not in boxes. (HK, high-molecular-weight kininogen; PK, prekallikrein.)

injury with the exposure of **tissue factor** (TF; Figure 55–1), located in the subendothelium and on activated monocytes. TF interacts with and activates **factor VII** (53 kDa, a zymogen containing vitamin K–dependent γ -carboxyglutamate [Gla] residues; see Chapter 44), synthesized in the liver. It should be noted that in the Gla-containing zymogens (factors II, VII, IX, and X), the Gla residues in the amino terminal regions of the molecules serve as high-affinity binding sites for Ca^{2+} . TF acts as a cofactor for **factor VIIa**, enhancing its enzymatic activity to activate **factor X** (56 kDa). The reaction by which **factor X** is activated requires the assembly of the **extrinsic tenase complex** (Ca^{2+} -TF-factor VIIa) formed on a cell membrane surface exposing the procoagulant anionic aminophospholipid phosphatidylserine. Factor VIIa cleaves an Arg-Ile bond in factor X to produce the two-chain serine protease, **factor Xa**. TF and factor VIIa also activate factor IX in the intrinsic pathway. Indeed, **the formation of complexes between membrane-bound TF and factor VIIa is now considered to be the key process involved in initiation of blood coagulation in vivo**.

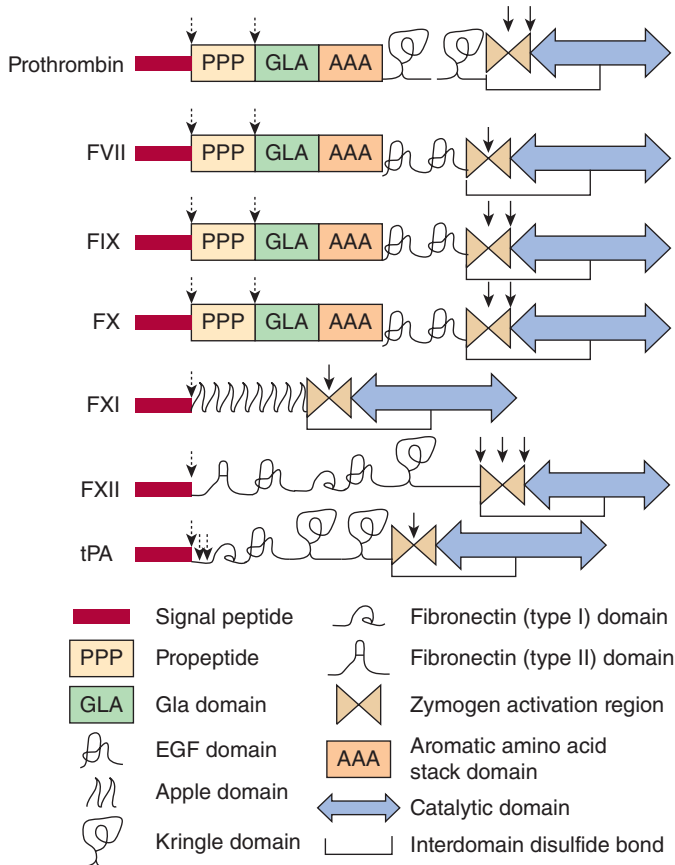

FIGURE 55-2 The structural domains of selected proteins involved in coagulation and fibrinolysis. Shared domains are a result of gene duplication and exon shuffling that contributed to the molecular evolution of the coagulation system. The domains are as identified at the bottom of the figure and include signal peptide, propeptide, Gla (γ -carboxyglutamate) domain, epidermal growth factor (EGF) domain, apple domain, kringle domain, fibronectin (types I and II) domain, the zymogen activation region, aromatic amino acid stack, and the catalytic domain. Interdomain disulfide bonds are indicated, but numerous intradomain disulfide bonds are not. Sites of proteolytic cleavage in synthesis or activation are indicated by arrows (dashed and solid, respectively). FVII, factor VII; FIX, factor IX; FX, factor X; FXI, factor XI; FXII, factor XII; tPA, tissue plasminogen activator. (Adapted, with permission, from Furie B, Furie BC: The molecular basis of blood coagulation. Cell 1988;53:505.)

Tissue factor pathway inhibitor (TFPI) is a major physiologic inhibitor of coagulation. TFPI is a protein that circulates in the blood where it directly inhibits factor Xa by binding to the enzyme near its active site. This factor Xa-TFPI complex then inhibits the factor VIIa-TF complex.

The Intrinsic Pathway Also Leads to Activation of Factor X

The formation of **factor Xa** is the major site where the intrinsic and extrinsic pathways converge (Figure 55-1). The **intrinsic pathway** (Figure 55-1) involves factors XII, XI, IX, VIII, and X, as well as prekallikrein, high-molecular-weight (HMW) kininogen, Ca^{2+} , and cell-surface exposed phosphatidylserine. This pathway results in the production of **factor Xa** by the

TABLE 55-1 Numerical System for Nomenclature of Blood Clotting Factors

Factor	Common Name
I	Fibrinogen
II	Prothrombin
III	Tissue factor
These factors are usually referred to by their common names	
IV	Ca^{2+}
Ca^{2+} is usually not referred to as a coagulation factor	
V	Proaccelerin, labile factor, accelerator (Ac-) globulin
VII ^a	Proconvertin, serum prothrombin conversion accelerator (SPCA), cothromboplastin
VIII	Antihemophilic factor A, antihemophilic globulin (AHG)
IX	Antihemophilic factor B, Christmas factor, plasma thromboplastin component (PTC)
X	Stuart-Prower factor
XI	Plasma thromboplastin antecedent (PTA)
XII	Hageman factor
XIII	Fibrin stabilizing factor (FSF), fibrinolygase

^aThere is no factor VI.

Note: The numbers indicate the order in which the factors have been discovered and bear no relationship to the order in which they act.

intrinsic tenase complex (see below for composition), in which factor IXa serves as the serine protease and factor VIIIa as the cofactor. As noted above, the activation of **factor X provides an important link between the intrinsic and extrinsic pathways.**

The **intrinsic pathway** can be initiated by “contact” in which prekallikrein, HMW kininogen, factor XII, and factor XI are exposed to a negatively charged activating surface. In vivo, polymers of phosphates, such as extracellular DNA, RNA, and polyphosphate (macromolecules available only following cell damage) may serve as this negatively charged activating surface. Kaolin, a highly negatively charged hydrated aluminum silicate, can be used for in vitro tests as an initiator of the intrinsic pathway. When the components of the contact phase assemble on the activating surface, factor XII is activated to **factor XIIa** upon proteolysis by kallikrein. This factor XIIa, generated by kallikrein, attacks prekallikrein to generate more kallikrein, setting up a positive feedback activation loop. Factor XIIa, once formed, activates **factor XI** to **XIa** and also releases **bradykinin** (a peptide with potent vasodilator action) from HMW kininogen.

In the presence of Ca^{2+} , factor XIa activates factor IX (55 kDa, a Gla-containing zymogen), to the serine protease, **factor IXa**. This, in turn, also cleaves an Arg-Ile bond in factor X to produce **factor Xa**. This latter reaction requires the assembly of components, called the **intrinsic tenase complex, composed of Ca^{2+} -factor VIIIa-factor X**, which forms on the membrane surface of platelets activated to expose procoagulant phosphatidylserine. (Note that this phospholipid is normally on the

TABLE 55-2 The Functions of the Proteins Involved in Blood Coagulation

Zymogens of Serine Proteases	
Factor XII	Binds to negatively charged surface, eg, kaolin, glass; activated by high-molecular-weight kininogen and kallikrein
Factor XI	Activated by factor XIIa
Factor IX	Activated by factor XIa and factor VIIIa
Factor VII	Activated by factor VIIa, factor Xa, and thrombin
Factor X	Activated on the surface of activated platelets by tenase complex (Ca^{2+} , factors VIIIa and IXa) and by the extrinsic tenase complex Ca^{2+} , tissue factor and factor VIIa)
Prothrombin Factor II	Activated on the surface of activated platelets by prothrombinase complex (Ca^{2+} , factors Va and Xa) to form thrombin [Factors II, VII, IX, and X are Gla-containing zymogens] (Gla = γ -carboxyglutamate)
Cofactors	
Factor VIII	Activated by thrombin; factor VIIIa is a cofactor in the activation of factor X by factor IXa
Factor V	Activated by thrombin; factor Va is a cofactor in the activation of prothrombin by factor Xa
Tissue factor (factor III)	A glycoprotein located in the subendothelium and expressed on activated monocytes to act as a cofactor for factor VIIa
Fibrinogen	
Factor I	Cleaved by thrombin to form fibrin clot
Thiol-Dependent Transglutaminase	
Factor XIII	Activated by thrombin; stabilizes fibrin clot by covalent cross-linking
Regulatory and Other Proteins	
Protein C	Activated to activated protein C (APC) by thrombin bound to thrombomodulin; then degrades factors VIIIa and Va
Protein S	Acts as a cofactor of protein C; both proteins contain Gla (γ -carboxyglutamate) residues
Thrombomodulin	Protein on the surface of endothelial cells; binds thrombin, which then activates protein C

internal side of the plasma membrane of resting, nonactivated platelets.)

Factor VIII (330 kDa), a circulating glycoprotein, is not a protease precursor but a cofactor that serves as a receptor on the platelet surface for factors IXa and X. Factor VIII is activated by minute quantities of thrombin to form **factor VIIIa**, which is in turn inactivated upon further cleavage by thrombin.

The role of the **initial steps of the intrinsic pathway** in initiating coagulation has been called into question because patients with a hereditary deficiency of factor XII, prekallikrein or HMW kininogen do not exhibit bleeding problems.

Similarly, patients with a deficiency of factor XI may not have bleeding problems. In experimental thrombosis models, deficiencies in the intrinsic pathway are protective against thrombosis. The intrinsic pathway largely serves to **amplify factor Xa** and ultimately **thrombin formation**, through feedback mechanisms (see below). The intrinsic pathway may also be important in **fibrinolysis** (see below) since kallikrein, factor XIIa, and factor XIa can cleave plasminogen and kallikrein can activate single-chain urokinase.

Factor Xa Leads to Activation of Prothrombin to Thrombin

Factor Xa, produced by either the extrinsic or the intrinsic pathway, activates **prothrombin** (factor II) to **thrombin** (factor IIa) (Figure 55-1).

The activation of prothrombin, like that of factor X, occurs on a membrane surface and requires the assembly of a **prothrombinase complex**, consisting of Ca^{2+} , factor Va, and factor Xa. The assembly of the prothrombinase complex, like that of the tenase complex, takes place on the phosphatidylserine-exposing membrane surface of activated platelets.

Factor V (330 kDa) is synthesized in the liver, spleen, and kidney and is found in platelets as well as in plasma. Factor V functions as a cofactor in a manner similar to that of factor VIII in the tenase complex. When activated to **factor Va** by traces of thrombin, it binds specifically to the platelet membrane (Figure 55-3) and forms a complex with factor Xa and prothrombin. It is subsequently inactivated by activated protein C (see below), thereby providing a means of limiting

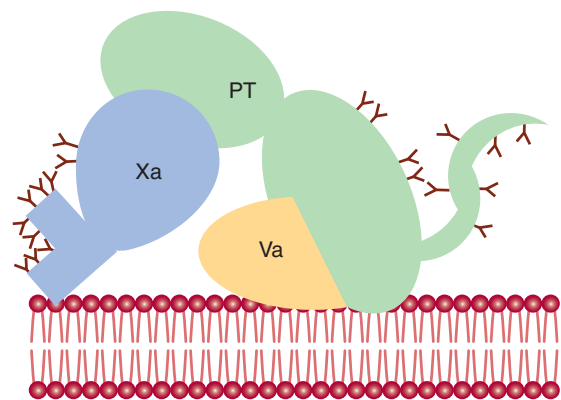

FIGURE 55-3 Diagrammatic representation (not to scale) of the binding of factors Va, Xa, and prothrombin (PT) to the plasma membrane of the activated platelet in the prothrombinase complex. A central theme in blood coagulation is the assembly of protein complexes, ie, the tenase complexes and the prothrombinase complex, on membrane surfaces on which phosphatidylserine is exposed in a Ca^{2+} -dependent fashion; the catalytic efficiency of zymogen activation is increased by many orders of magnitude by the membrane-bound complexes. Gamma-carboxyglutamate residues (indicated by Y) on vitamin K-dependent proteins bind calcium and contribute to the exposure of membrane binding sites on these proteins. (Adapted, with permission, from Furie B, Furie BC: The molecular basis of blood coagulation. Cell 1988;53:505.)

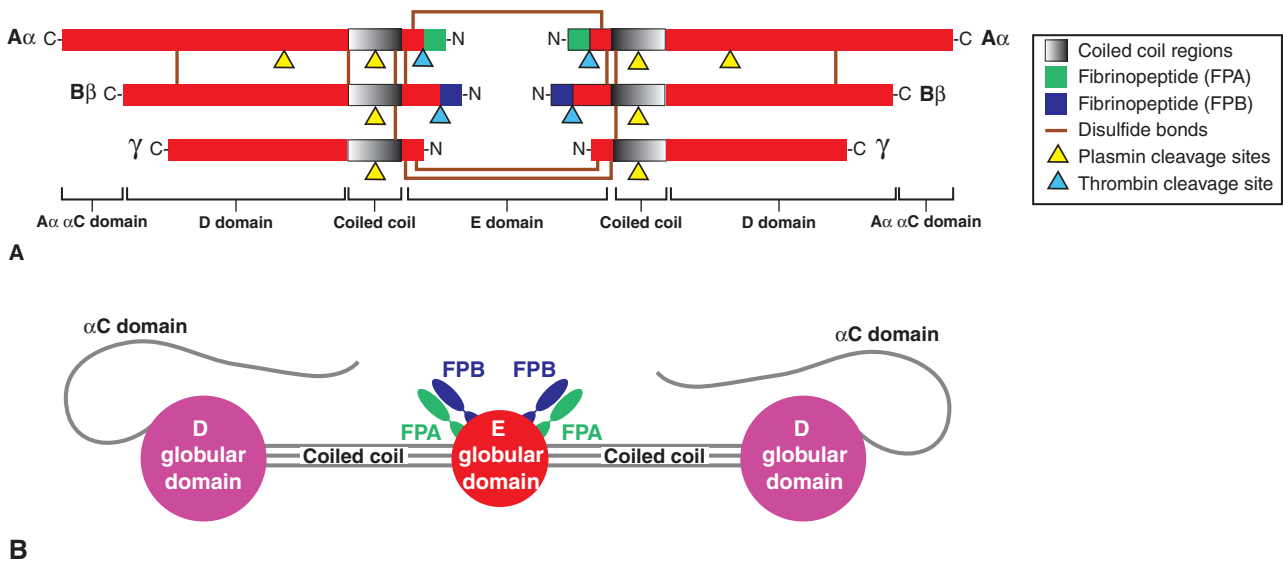

FIGURE 55-4 Diagrammatic representation of fibrinogen. (A) Fibrinogen is a dimeric molecule, with each half composed of three polypeptide chains: $A\alpha$, $B\beta$, and γ . Disulfide bonds join together the chains and the two halves of the molecule. (B) Fibrinogen forms a trinodular structure with a central E domain linked via coiled coil regions to two lateral D domains each of which contains a flexible $A\alpha$ chain αC domain. The thrombin-cleaved regulatory peptides fibrinopeptide A (FPA) and fibrinopeptide B (FPB) reside within the E nodule as shown. (Figure modified from Weitz JI: Overview of hemostasis and thrombosis. In: Hoffman R, Benz EJ Jr, Silberstein LR, et al [editors]: *Hematology: Basic Principles and Practice*, 6th ed. Elsevier Saunders, 2013:1779.)

the activation of prothrombin to thrombin. **Prothrombin** (72 kDa; Figure 55-3) is a single-chain glycoprotein synthesized in the liver. The amino terminal region of prothrombin (Figure 55-2) contains 10 Glu residues, and the serine-dependent active protease site is in the catalytic domain close to the carboxyl terminal region of the molecule. Upon binding to the complex of factors Va and Xa on the platelet membrane (Figure 55-3), prothrombin is cleaved by factor Xa at two sites to generate the active, two-chain thrombin molecule, which is then released from the platelet surface.

Conversion of Fibrinogen to Fibrin Is Catalyzed by Thrombin

Thrombin, produced by the prothrombinase complex, in addition to having a potent stimulatory effect on platelets (see below), **converts fibrinogen to fibrin** (Figure 55-1). **Fibrinogen** (aka factor I, 340 kDa; see Figures 55-1 and 55-4; Tables 55-1 and 55-2) is an abundant (3 mg/mL) soluble plasma glycoprotein that consists of a dimer of three polypeptide chains, ($A\alpha$, $B\beta$, γ)₂, that is covalently linked by 29 disulfide bonds. The $B\beta$ and γ chains contain asparagine-linked complex oligosaccharides (see Chapter 46). All three chains are synthesized in the liver; the three genes encoding these proteins are on the same chromosome where their expression is coordinately regulated in humans. The amino terminal regions of the six chains are held in close proximity by a number of disulfide bonds (a subset is shown in Figure 55-4), while the carboxyl terminal regions are spread apart. Thus, the fibrinogen molecule has a trinodular, elongated structure with a central E domain that is linked to lateral D domains

via coiled coil regions (Figures 55-4 and 55-5A). The N-terminal A and B portions of the $A\alpha$ and $B\beta$ chains are termed **fibrinopeptide A (FPA)** and **fibrinopeptide B (FPB)**, respectively; these domains are highly negatively charged as a result of an abundance of aspartate and glutamate residues (see below). The negative charges contribute to the solubility of fibrinogen in plasma and importantly also serve to prevent aggregation by causing electrostatic repulsion between fibrinogen molecules.

Thrombin (34 kDa), the serine protease formed by the prothrombinase complex, hydrolyzes the four Arg-Gly bonds between the N-terminal fibrinopeptides and the α and β portions of the $A\alpha$ and $B\beta$ chains of fibrinogen (Figure 55-5A, B). The release of FPA and FPB by thrombin generates **fibrin monomer**, which has the subunit structure (α , β , γ)₂. Since FPA and FPB contain only 16 and 14 residues, respectively, the fibrin molecule retains 98% of the residues present in fibrinogen. The removal of the fibrinopeptides exposes binding sites within the E-domain of fibrin monomers that specifically interact with complementary domains within the D-domains of other fibrin monomers. In this way, fibrin monomers spontaneously polymerize in a half-staggered pattern to form long strands (protofibrils) (Figure 55-5A). Although insoluble, this initial fibrin clot is unstable, held together only by the noncovalent association of fibrin monomers.

In addition to converting fibrinogen to fibrin, thrombin also activates **factor XIII to factor XIIIa**. Factor XIIIa is a highly specific **transglutaminase** that covalently cross-links γ -chains and, more slowly, α -chains of fibrin molecules by forming peptide bonds between the amide groups of glutamine and the ϵ -amino groups of lysine residues (see Figure 51-5C).

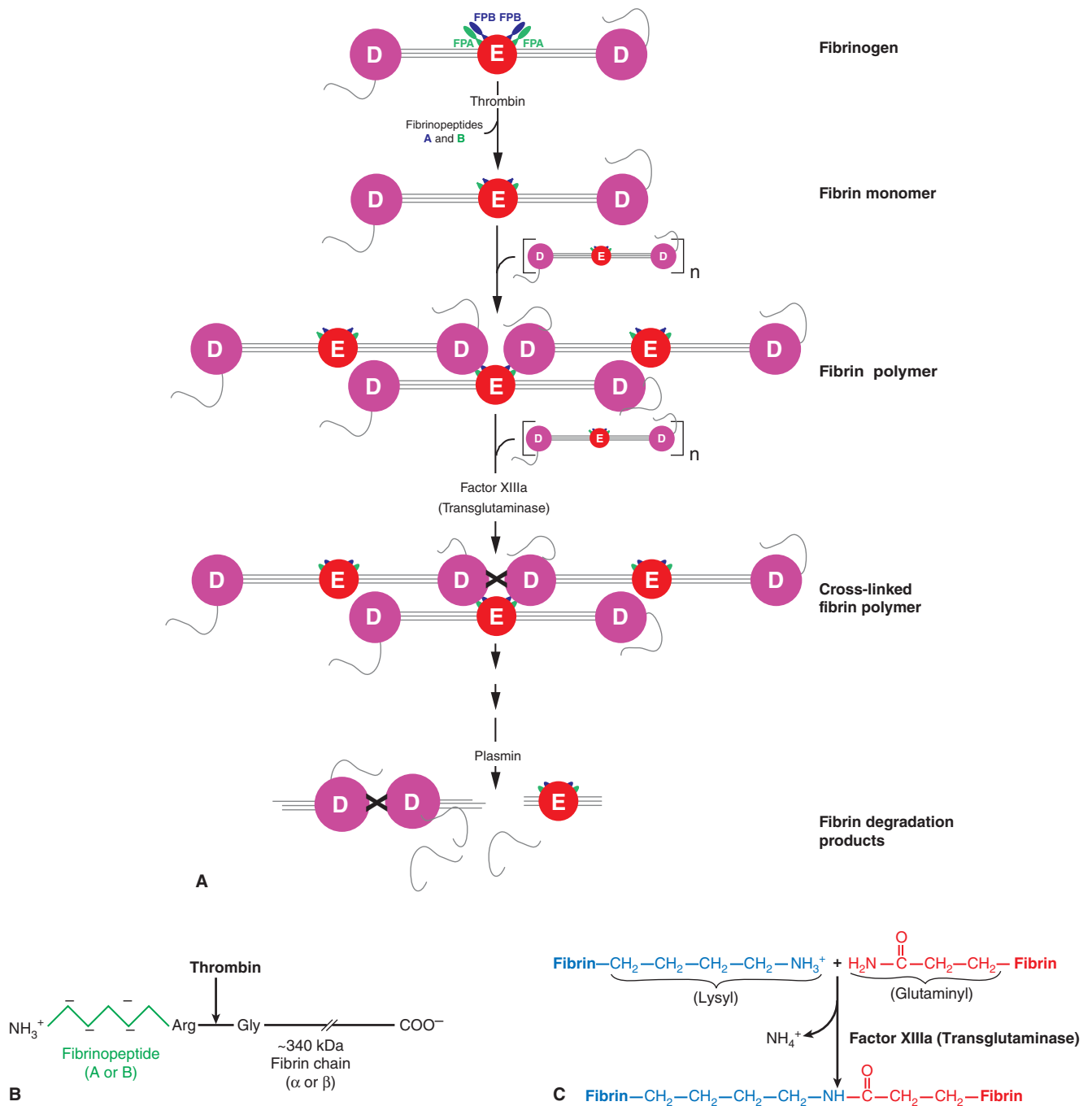

FIGURE 55-5 Fibrin polymerization and degradation. (A) The formation of fibrin monomer via cleavage of fibrinopeptide A (FPA) and fibrinopeptide B (FPB) from fibrinogen by thrombin; the spontaneous polymerization of fibrin monomers to dimers and higher oligomers: followed by the stabilization of fibrin oligomers by factor XIIIa-mediated covalent crosslinking of adjacent fibrin monomers. Finally (bottom), is illustrated the degradation of fibrin polymers into soluble degradation products by plasmin digestion, which leads to clot dissolution. Figure modified from Weitz JI: Overview of hemostasis and thrombosis. In Hoffman R, Benz Jr EJ, Silberstein LR, et al (editors): *Hematology: Basic Principles and Practice*, 6th ed. Elsevier Saunders, 2013, pp. 1779.) (B) Thrombin cleavage site of the α and β chains of fibrinogen to yield FPA/FPB (left; green) and the α and β chains of fibrin monomer (right; black). (C) Schematic of factor XIIIa (transglutaminase)-mediated cross-linking of fibrin molecules. (Figure modified from Weitz JI: Overview of hemostasis and thrombosis. In: Hoffman R, Benz EJ Jr, Silberstein LR, et al (editors): *Hematology: Basic Principles and Practice*, 6th ed. Elsevier Saunders, 2013:1779.)

Such crosslinking yields a more stable fibrin clot with increased resistance to proteolysis. This fibrin mesh serves to stabilize the hemostatic plug or thrombus.

Levels of Circulating Thrombin Are Carefully Controlled

Once active thrombin is formed in the course of hemostasis or thrombosis, its concentration must be carefully controlled to prevent further fibrin formation or platelet activation. This is achieved in **two ways**. Thrombin circulates as its inactive precursor, prothrombin, which is activated as a result of a cascade of enzymatic reactions, each converting an inactive zymogen to an active enzyme and leading finally to the conversion of prothrombin to thrombin (Figure 55–1). At each point in the cascade, **feedback mechanisms** produce a delicate balance of activation and inhibition. The concentration of factor XII in plasma is approximately 30 $\mu\text{g/mL}$, while that of fibrinogen is 3 mg/mL , with intermediate clotting factors increasing in concentration as one proceeds down the cascade; these facts illustrate that the clotting cascade provides **amplification**. The second means of controlling thrombin activity is **the inactivation of any thrombin** formed by **circulating inhibitors**, the most important of which is antithrombin (see below).

The Activity of Antithrombin, an Inhibitor of Thrombin, Is Increased by Heparin

Four naturally occurring **thrombin inhibitors** exist in normal plasma. The most important is **antithrombin**, which contributes approximately 75% of the antithrombin activity. Antithrombin can also inhibit the activities of factors IXa, Xa, XIa, XIIa, and VIIa complexed with tissue factor. **α_2 -Macroglobulin** contributes most of the remainder of the antithrombin activity, with **heparin cofactor II** and **α_1 -antitrypsin** acting as minor inhibitors under physiologic conditions.

The endogenous activity of antithrombin is greatly potentiated by the presence of sulfated glycosaminoglycans (heparans) (see Chapter 48). Heparans bind to a specific cationic site of antithrombin, which induces a conformational change that promotes binding of antithrombin to thrombin, as well as to its other substrates. This mechanism is the basis for the use of **heparin**, a derivatized heparan, in clinical medicine to inhibit coagulation. The anticoagulant effects of heparin can be antagonized by strongly cationic polypeptides such as **protamine**, which bind strongly to heparin, thus inhibiting heparin binding to antithrombin.

Low-molecular-weight heparins (LMWHs), derived from enzymatic or chemical cleavage of unfractionated heparin, are finding increasing clinical use. They can be administered subcutaneously at home, have greater bioavailability than unfractionated heparin, and do not need frequent laboratory monitoring.

Individuals with **inherited deficiencies of antithrombin** are prone to develop venous thrombosis, providing evidence that antithrombin has a physiologic function and that the coagulation system in humans is normally in a dynamic state.

Thrombin is involved in an additional regulatory mechanism that operates in coagulation. It combines with **thrombomodulin**, a glycoprotein present on the surfaces of endothelial cells. The complex activates **protein C** on the **endothelial protein C receptor**. In combination with **protein S**, **activated protein C (APC)** degrades factors Va and VIIIa, thereby limiting their actions in coagulation. A genetic deficiency of either protein C or protein S can cause venous thrombosis. Furthermore, patients with **factor V Leiden** (which has a glutamine residue in place of an arginine at position 506) have an increased risk of venous thrombotic disease because factor V Leiden is resistant to inactivation by APC; this condition is.

Coumarin Anticoagulants Inhibit the Vitamin K–Dependent Carboxylation of Factors II, VII, IX, & X

The **coumarin drugs** (eg, warfarin), which are used as anticoagulants, inhibit the vitamin K–dependent carboxylation of Glu to Gla residues (see Chapter 44) in the amino terminal regions of factors II, VII, IX, and X and also proteins C and S. These proteins, all of which are synthesized in the liver, are dependent on the Ca^{2+} -binding properties of the Gla residues for their normal function in the coagulation pathways. **Coumarins inhibit the reduction of the quinone derivatives of vitamin K to the active hydroquinone forms** (see Chapter 44). Thus, the administration of vitamin K will bypass the coumarin-induced inhibition and allow the post-translational modification of carboxylation to occur. **Reversal** of coumarin inhibition by vitamin K requires 12 to 24 hours, whereas reversal of the anticoagulant effects of heparin by protamine is almost instantaneous.

Heparin and **warfarin** are used in the treatment of thrombotic and thromboembolic conditions, such as deep vein thrombosis and pulmonary embolism. Heparin is administered first, because of its prompt onset of action, whereas warfarin takes several days to reach full effect. Their effect is not well predictable by dosage, and thus because of the risk of producing hemorrhage, these drugs are closely monitored by use of appropriate tests of coagulation (see below).

New oral inhibitors of thrombin (dabigatran) or of factor Xa (rivaroxaban, apixaban and others) are also used in the prevention and treatment of thrombotic conditions. These drugs are advantageous because their effect is predictable based on the dose, and some do not require routine monitoring by laboratory tests.

There Are Several Hereditary Bleeding Disorders, Including Hemophilia A

Inherited deficiencies of the clotting system that result in bleeding are found in humans. The most common is deficiency of factor VIII, causing **hemophilia A**, an X chromosome-linked disease. **Hemophilia B**, also **X chromosome-linked**, is due to a deficiency of factor IX and has recently been identified

as the form of hemophilia that played a major role in the history of the royal families of Europe. The clinical features of hemophilia A and B are almost identical, but these two diseases can be readily distinguished on the basis of specific assays for the two factors.

The **gene for human factor VIII** measures 186 kb in length, and contains 26 exons that encode a protein of 2351 amino acids. A variety of mutations in the factor VIII and IX genes have been detected leading to diminished activities of the factor VIII and IX proteins; these include partial gene deletions and point and missense mutations. **Prenatal diagnosis** by DNA analysis after chorionic villus sampling is now possible (see Figure 39–9).

In the past, treatment for patients with hemophilia A and B consisted of administration of **cryoprecipitates** (enriched in factor VIII) prepared from individual donors or lyophilized factor VIII or IX **concentrates** prepared from very large plasma pools. It is now possible to prepare factors VIII and IX by recombinant DNA technology (see Chapter 39). Such preparations are free of contaminating viruses (eg, hepatitis A, B, C, or HIV-1) found in human plasma, but are expensive; their use will increase as the cost of production decreases.

The most common hereditary bleeding disorder is **von Willebrand disease**, with a prevalence of up to 1% of the population. It results from a deficiency or defect in **von Willebrand factor**, a large multimeric glycoprotein that is secreted by endothelial cells and platelets into the plasma, where it stabilizes factor VIII. von Willebrand factor also promotes platelet adhesion at sites of vessel wall injury (see below).

Fibrin Clots Are Dissolved by Plasmin

As stated above, the coagulation system is normally in a state of dynamic equilibrium in which fibrin clots are constantly being laid down and dissolved. This latter process is termed **fibrinolysis**. **Plasmin**, the serine protease mainly responsible for degrading fibrin and fibrinogen, circulates in the form of its inactive zymogen, **plasminogen** (90 kDa), and any small amounts of plasmin that are formed in the fluid phase under physiologic conditions are rapidly inactivated by the fast-acting plasmin inhibitor, α_2 -antiplasmin. Plasminogen binds to fibrin and thus becomes incorporated in clots as they are produced; since plasmin that is formed when bound to fibrin is protected from α_2 -antiplasmin, it remains active. **Activators of plasminogen** of various types are found in most body tissues, and all cleave the same Arg-Val bond in plasminogen to produce the disulfide bridge-linked two-chain serine protease, plasmin (**Figure 55–6**). The **specificity of plasmin for fibrin** is another mechanism to regulate fibrinolysis. Via one of its kringle domains, plasmin(ogen) specifically binds lysine residues on fibrin and so is increasingly incorporated into the fibrin mesh as it cleaves it. (Kringle domains [Figure 55–2] are common protein motifs of about 100-amino-acid residues in length; they have a characteristic covalent structure defined by a pattern of three disulfide bonds.) Thus, the carboxypeptidase **TAFIa (activated thrombin activatable fibrinolysis**

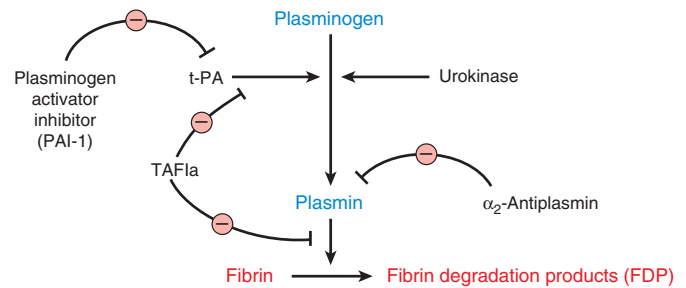

FIGURE 55-6 Initiation of fibrinolysis by the activation of plasminogen to plasmin. Scheme of sites and modes of action of tissue plasminogen activator (t-PA), urokinase, plasminogen activator inhibitor, α_2 -antiplasmin, and thrombin-activatable fibrinolysis inhibitor (TAFIa).

inhibitor) (Figure 55–6), which removes terminal lysines from fibrin, is able to inhibit fibrinolysis. Thrombin activates TAFI to TAFIa, thereby inhibiting fibrinolysis during clot formation.

Tissue plasminogen activator (t-PA) (Figures 55–2 and 55–6) is a serine protease that is released into the circulation from vascular endothelium under conditions of injury or stress and is catalytically inactive unless bound to fibrin. Upon binding to fibrin, t-PA cleaves plasminogen within the clot to generate plasmin, which in turn digests the fibrin to form soluble degradation products and thus dissolves the clot. Neither plasmin nor the plasminogen activator can remain bound to these degradation products, and so they are released into the fluid phase where they are inactivated by their natural inhibitors. Prourokinase is the precursor of a second activator of plasminogen, **urokinase**. Originally isolated from urine, it is now known that urokinase is synthesized by various cell types including monocytes and macrophages, fibroblasts, and epithelial cells. The main action of urokinase appears to be the degradation of extracellular matrix. Figure 55–6 indicates the sites of action of five proteins that influence the formation and action of plasmin.

Recombinant t-PA & Streptokinase Are Used as Clot Busters

t-PA, marketed as **Alteplase**, is produced by recombinant DNA methods. It is used therapeutically as a fibrinolytic agent, as is **streptokinase**, an enzyme secreted by a number of streptococcal bacterial strains. However, the latter is less selective than t-PA, activating plasminogen in the fluid phase (where it can degrade circulating fibrinogen) as well as plasminogen that is bound to a fibrin clot. The amount of plasmin produced by therapeutic doses of streptokinase may exceed the capacity of the circulating α_2 -antiplasmin, causing fibrinogen as well as fibrin to be degraded and resulting in the bleeding often encountered during fibrinolytic therapy. Because of its relative **selectivity** for degrading fibrin, recombinant t-PA has been widely used to restore the patency of coronary arteries following thrombosis. If administered early enough, before irreversible damage of heart muscle occurs (about 6 hours after onset of thrombosis), t-PA can significantly reduce the mortality rate from myocardial damage following coronary thrombosis. Streptokinase has

also been widely used in the treatment of coronary thrombosis, but has the disadvantage of being antigenic. t-PA has also been used in the treatment of ischemic stroke, peripheral arterial occlusion, deep vein thrombosis and pulmonary embolism.

There are a number of disorders, including cancer and sepsis, in which the concentrations of plasminogen activators increase. In addition, the antiplasmin activities contributed by α_1 -antitrypsin and α_2 -antiplasmin may be impaired in diseases such as cirrhosis. Since certain bacterial proteins, such as streptokinase, are capable of activating plasminogen,

they may be responsible for the diffuse hemorrhage sometimes observed in patients with disseminated bacterial infections.

Platelet Aggregation Requires Outside-In and Inside-Out Transmembrane Signaling

Platelets normally circulate in an unstimulated disk-shaped form. During hemostasis or thrombosis, platelets become activated and help form hemostatic plugs or thrombi (Figure 55-7). Three major steps are involved: (1) adhesion

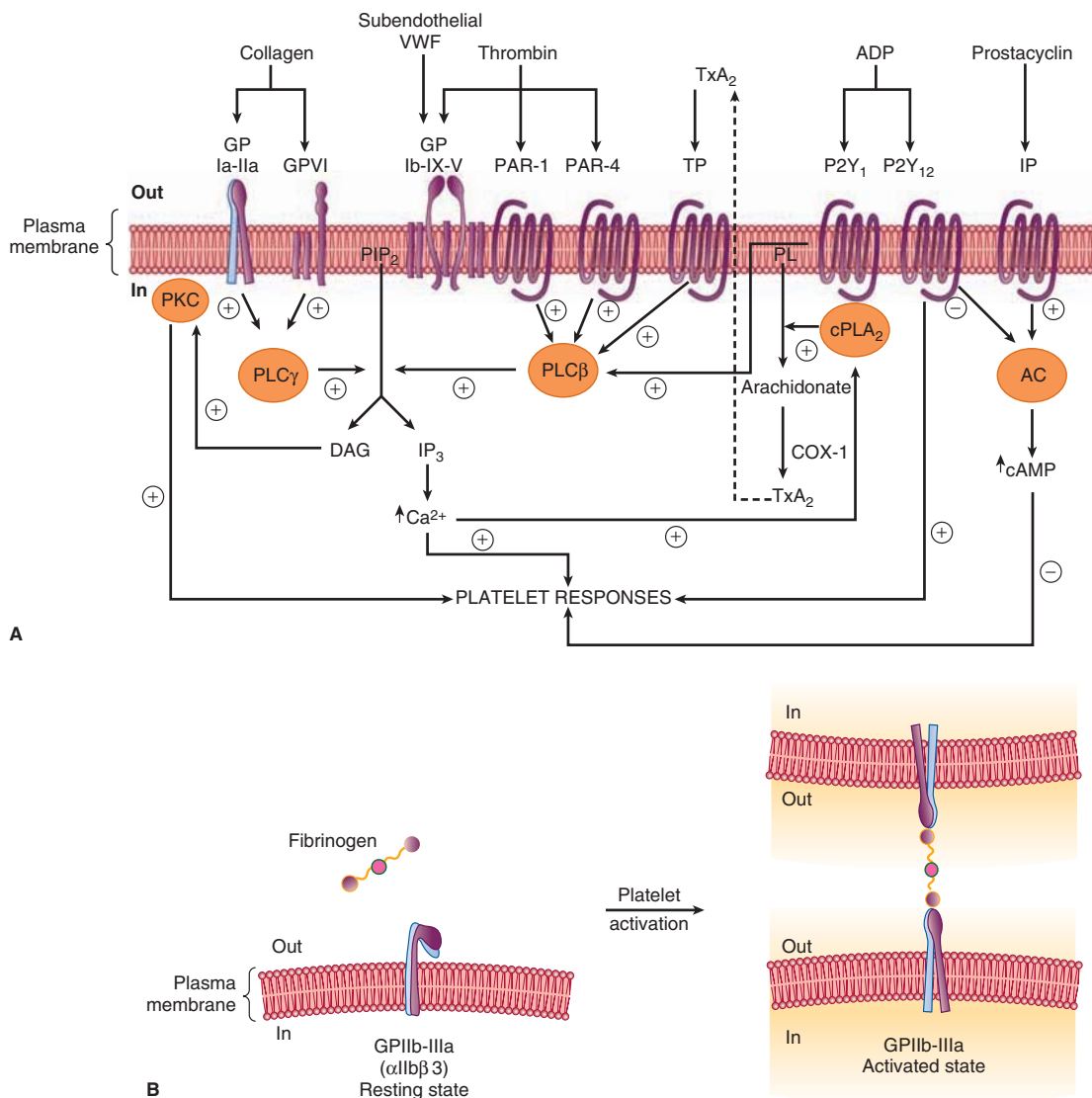

FIGURE 55-7 (A) Diagrammatic representation of platelet activation by collagen, thrombin, thromboxane A₂ and ADP, and inhibition by prostacyclin. The external environment, the plasma membrane, and the inside of a platelet are depicted from top to bottom. Platelet responses include, depending on the agonist, change of platelet shape, release of the contents of the storage granules, and aggregation. (AC, adenyl cyclase; cAMP, cyclic AMP; COX-1, cyclooxygenase-1; cPLA₂, cytosolic phospholipase A₂; DAG, 1,2-diacylglycerol; GP, glycoprotein; IP, prostacyclin receptor; IP₃, inositol 1,4,5-trisphosphate; P2Y₁, P2Y₁₂, purinoceptors; PAR, protease activated receptor; PIP₂, phosphatidylinositol 4,5-bisphosphate; PKC, protein kinase C; PL, phospholipid; PLC β , phospholipase C β ; PLC γ , phospholipase C γ ; TP, thromboxane A₂ receptor; TxA₂, thromboxane A₂; VWF, von Willebrand factor.) The G proteins that are involved are not shown. **(B) Diagrammatic representation of platelet aggregation mediated by fibrinogen binding to activated GPIIb-IIIa molecules on adjacent platelets.** Signaling events initiated by all aggregating agents transform GPIIb-IIIa from its resting state to an activated form that can bind divalent fibrinogen or, at the high shear that occurs in small vessels, multivalent von Willebrand factor.

to exposed collagen in blood vessels, (2) release (exocytosis) of the contents of their storage granules, and (3) aggregation.

Platelets adhere to collagen via specific receptors on the platelet surface, including the glycoprotein complexes GPIa-IIa ($\alpha 2\beta 1$ integrin; Chapter 52) and GPIb-IX-V, and GPVI. The binding of GPIb-IX-V to collagen is mediated via von Willebrand factor; this interaction is especially important in platelet adherence to the subendothelium under conditions of high shear stress that occur in small vessels and partially stenosed arteries.

Platelets that are bound to collagen change shape and spread out on the subendothelium. These adherent platelets release the contents of their **storage granules** (the dense granules and the alpha granules); some of the molecules released amplify the responses to vessel wall injury. Granule release is also stimulated by thrombin.

Thrombin, formed from the coagulation cascade, is the most potent activator of platelets and initiates activation by interacting with its receptors **PAR (protease-activated receptor)-1**, **PAR-4**, and **GPIb-IX-V** on the platelet plasma membrane (Figure 55–7A). The further events leading to platelet activation upon binding to PAR-1 and PAR-4 are examples of outside-in **transmembrane signaling**, in which a chemical messenger outside the cell generates effector molecules inside the cell. In this instance, thrombin acts as the external chemical messenger (stimulus or agonist). The interaction of thrombin with its G protein–coupled receptors PAR-1 and PAR-4 stimulates the activity of an intracellular **phospholipase C β (PLC β)**. This enzyme hydrolyzes the membrane phospholipid **phosphatidylinositol 4,5-bisphosphate (PIP₂)**, a polyphosphoinositide) to form the two internal effector molecules (**1,2-diacylglycerol (DAG)** and **1,4,5-inositol trisphosphate (IP₃)**); see Figure 42–7).

Hydrolysis of PIP₂ is also involved in the action of many hormones and drugs. DAG stimulates **protein kinase C**, which phosphorylates the protein **pleckstrin** (47 kDa). This results in aggregation and release of the contents of the storage granules. **ADP** released from dense granules can also activate platelets via its specific G protein–coupled receptors (Figure 55–7A), resulting in aggregation of additional platelets. **IP₃** causes release of Ca²⁺ into the cytosol mainly from the dense tubular system (or residual smooth endoplasmic reticulum from the megakaryocyte), which then interacts with calmodulin and myosin light chain kinase, leading to phosphorylation of the light chains of myosin. These chains then interact with actin, causing changes of platelet shape.

Collagen-induced activation of a platelet **cytosolic phospholipase A₂** by increased levels of intracellular Ca²⁺ results in liberation of arachidonic acid from platelet membrane phospholipids, leading to the formation of **thromboxane A₂** (see Chapter 23). Thromboxane A₂, in turn, by binding to its specific G protein–coupled receptor, can further activate PLC β , promoting platelet aggregation (Figure 55–6A).

Activated platelets, besides forming a platelet aggregate, accelerate the activation of factor X and prothrombin by exposing the anionic phospholipid phosphatidylserine on their membrane surface (Figure 55–1). Polyphosphate,

released from the dense granules, accelerates factor V activation and also accelerates factor XI activation by thrombin.

All of the **aggregating agents**, including thrombin, collagen, ADP, and others such as platelet-activating factor, via an inside-out signaling pathway, modify the platelet surface **glycoprotein complex GPIIb-IIIa** ($\alpha \text{IIb}\beta 3$; see Chapter 52) so that the receptor has a higher affinity for **fibrinogen** or **von Willebrand factor** (Figure 55–7B). Molecules of divalent fibrinogen or multivalent von Willebrand factor then link adjacent activated platelets to each other, forming a platelet aggregate. von Willebrand factor-mediated platelet aggregation occurs under conditions of high shear stress. Some agents, including epinephrine, serotonin, and vasopressin, exert synergistic effects with other aggregating agents.

Endothelial Cells Synthesize Prostacyclin & Other Compounds That Affect Clotting & Thrombosis

The **endothelial cells** in the walls of blood vessels make important contributions to the overall regulation of hemostasis and thrombosis. As described in Chapter 23, these cells synthesize the prostanoid **prostacyclin** (PGI₂), a potent inhibitor of platelet aggregation. Prostacyclin acts by stimulating the activity of adenylyl cyclase in the surface membranes of platelets via its G protein–coupled receptor (Figure 55–7A). The resulting increase of intraplatelet **cAMP** opposes the increase in the level of intracellular Ca²⁺ produced by IP₃ and thus inhibits platelet activation. This is in contrast with the effect of the prostanoid thromboxane A₂ that is formed by activated platelets, which is that of promoting aggregation. Endothelial cells play other roles in the regulation of thrombosis. For instance, these cells possess an **ADPase**, which hydrolyzes ADP, and thus opposes its aggregating effect on platelets. In addition, these cells appear to synthesize **heparan sulfate**, an anticoagulant, and they also synthesize **plasminogen activators**, which may help dissolve thrombi. **Table 55–3** lists some molecules produced by endothelial cells that affect thrombosis and fibrinolysis. **Nitric oxide** (endothelium-derived relaxing factor) is discussed in Chapter 49.

Analysis of the mechanisms of **uptake of atherogenic lipoproteins**, such as LDL, by endothelial, smooth muscle, and monocytic cells of arteries, along with detailed studies of how these lipoproteins damage such cells is a key area of study in elucidating the mechanisms of **atherosclerosis** (see Chapter 26).

Aspirin Is One of Several Effective Antiplatelet Drugs

Antiplatelet drugs inhibit platelet responses. The most commonly used antiplatelet drug is **aspirin (acetylsalicylic acid)**, which irreversibly acetylates and thus inhibits the platelet **cyclooxygenase (COX-1)** involved in formation of thromboxane A₂ (see Chapter 15), a potent aggregator of platelets and also a vasoconstrictor. Platelets are very sensitive to aspirin; as little as 30 mg/d (one regular aspirin tablet contains

TABLE 55-3 Molecules Synthesized by Endothelial Cells That Play a Role in the Regulation of Thrombosis and Fibrinolysis

Molecule	Action
ADPase (CD39, an ectoenzyme)	Degrades ADP (an aggregating agent of platelets) to AMP + Pi
Nitric oxide (NO)	Inhibits platelet adhesion and aggregation by elevating levels of cGMP
Prostacyclin (PGI ₂ , a prostaglandin)	Inhibits platelet aggregation by increasing levels of cAMP
Thrombomodulin (a glycoprotein)	Binds thrombin, which then cleaves protein C to yield activated protein C; this in combination with protein S degrades factors Va and VIIIa, limiting their actions
Endothelial protein C receptor (EPCR, a glycoprotein)	Facilitates protein C activation by the thrombin-thrombomodulin complex
Tissue plasminogen activator (t-PA, a protease)	Activates plasminogen to plasmin, which digests fibrin; the action of t-PA is opposed by plasminogen activator inhibitor-1 (PAI-1)

Source: Adapted, with permission, from Wu KK: Endothelial cells in hemostasis, thrombosis and inflammation. *Hosp Pract (Off Ed)* 1992;27:145.

325 mg) effectively eliminates the synthesis of thromboxane A₂. Aspirin also inhibits production of prostacyclin (PGI₂, which opposes platelet aggregation and is a vasodilator) by endothelial cells, but unlike platelets, these cells regenerate cyclooxygenase within a few hours. Thus, the overall balance between thromboxane A₂ and prostacyclin can be shifted in favor of the latter, opposing platelet aggregation. Indications for treatment with aspirin include management of acute coronary syndromes (angina, myocardial infarction), acute stroke syndromes (transient ischemic attacks, acute stroke), severe carotid artery stenosis, and primary prevention of these and other atherothrombotic diseases.

Other **antiplatelet drugs** include **clopidogrel**, **prasugrel**, and **ticagrelor**, specific inhibitors of the P2Y₁₂ receptor for ADP, and antagonists of ligand binding to GPIIb-IIIa (eg, **abciximab**) that interfere with fibrinogen and von Willebrand factor binding and thus platelet aggregation.

Laboratory Tests Measure Coagulation, Thrombolysis, & Platelet Aggregation

A number of **laboratory tests** are available to **measure the phases of hemostasis** described above. The tests include **platelet count**, **bleeding time/closure time**, **platelet aggregation**, **activated partial thromboplastin time (aPTT or PTT)**, **prothrombin time (PT)**, **thrombin time (TT)**, **concentration of fibrinogen**, **fibrin clot stability**, and **measurement of fibrin degradation products**. The **platelet count** quantitates the number of platelets.

The **skin bleeding time** is an overall test of platelet and vessel wall function, while the **closure time** measured using the platelet function analyzer PFA-100 is an in vitro test of platelet-related hemostasis. **Platelet aggregation** measures responses to specific aggregating agents. **aPTT** is a measure of the intrinsic pathway and **PT** of the extrinsic pathway, with **aPTT** being used to monitor heparin therapy and **PT**, to measure the effectiveness of warfarin. The reader is referred to a textbook of hematology for a discussion of these tests.

SUMMARY

- Hemostasis and thrombosis are complex processes involving coagulation factors, platelets, and blood vessels.
- Many coagulation factors are zymogens of serine proteases, becoming activated, then inactivated during the overall process.
- Both extrinsic and intrinsic pathways of coagulation exist, the former initiated in vivo by tissue factor. The pathways converge at factor Xa, ultimately resulting in thrombin-catalyzed conversion of fibrinogen to fibrin, which is strengthened by covalent cross-linking, catalyzed by factor XIIIa.
- Genetic disorders that lead to bleeding occur; the principal disorders involve factor VIII (hemophilia A), factor IX (hemophilia B), and von Willebrand factor (von Willebrand disease).
- Antithrombin is an important natural inhibitor of coagulation; genetic deficiency of this protein can result in thrombosis.
- Factors II, VII, IX, and X and proteins C and S require vitamin K-dependent γ -carboxylation of certain glutamate residues to function in coagulation. This carboxylation process can be inhibited by the anticoagulant warfarin.
- Fibrin is dissolved by plasmin. Plasmin exists as an inactive precursor, plasminogen, which can be activated by tissue plasminogen activator (t-PA). t-PA is widely used clinically to treat early thrombosis in the coronary arteries.
- Thrombin and other agents cause platelet aggregation, which involves a variety of biochemical and morphologic events. Stimulation of phospholipase C and the polyphosphoinositide pathway is a key event in platelet activation, but other processes are also involved.
- Aspirin is an important antiplatelet drug that acts by inhibiting production of thromboxane A₂.

REFERENCES

- Hoffman R, Benz EJ Jr, Silberstein LR, et al (editors): *Hematology: Basic Principles and Practice*, 6th ed. Elsevier Saunders, 2013.
- Israels SJ (editor): *Mechanisms in Hematology*, 4th ed. Core Health Sciences Inc, 2011. (This text has many excellent illustrations of basic mechanisms in hematology.)
- Longo DL, Fauci AS, Kasper DL, et al: *Harrison's Principles of Internal Medicine*, 18th ed. McGraw-Hill, 2011.
- Marder VJ, Aird WC, Bennett JS, et al (editors): *Hemostasis and Thrombosis: Basic Principles and Clinical Practice*, 6th ed. Lippincott Williams & Wilkins, 2013.
- Michelson AD (editor): *Platelets*, 3rd ed. Elsevier, 2013.

Cancer: An Overview

Molly Jacob, MBBS, MD, PhD, Joe Varghese, MBBS, MD,
Robert K. Murray, MD, PhD & P. Anthony Weil, PhD

OBJECTIVES

*After studying this chapter,
you should be able to:*

- Present an overview of important aspects of the biochemical and genetic features of cancer cells.
- Describe important properties of oncogenes and tumor suppressor genes.
- Briefly describe the concepts of genomic instability, aneuploidy, and angiogenesis in tumors.
- Discuss the use of tumor markers for following responses to treatments and to detect recurrences.
- Appreciate that recent understanding of the biology of cancer has led to the development of various new therapies.

BIOMEDICAL IMPORTANCE

Cancers constitute the **second most common cause of death**, after cardiovascular disease, in the United States and many other countries. Approximately 8 million people around the world die from cancer each year, and this figure is projected to increase. Humans of all ages develop cancer, and a wide variety of organs are affected. Worldwide, the main types of cancer accounting for mortality are those involving the lung, stomach, colon, rectum, liver, and breast. Other types of cancers that lead to death include cervical, esophageal, and prostate cancers. Skin cancers are very common, but apart from melanomas, are generally not as aggressive as those mentioned above. The **incidence** of many cancers **increases with age**. Hence, as people live longer, many more will develop the disease. Hereditary factors play a role in some types of tumors. Apart from great individual suffering caused by the disease, the economic burden to society is immense.

SOME GENERAL COMMENTS ON NEOPLASMS

A neoplasm refers to any abnormal new growth of tissue. It may be benign or malignant in nature. The term “cancer” is usually associated with malignant tumors. Tumors can arise in any organ in the body and result in different clinical features, depending on the location of the growth.

Cancer cells are characterized by certain **key properties**: they (1) **proliferate rapidly**; (2) **display diminished growth control**; (3) display **loss of contact inhibition** in vitro; (4) **invade local tissues** and spread, or **metastasize**, to other parts of the body; (5) are **self-sufficient in growth signals** and are **insensitive to antigrowth signals**; (6) stimulate local **angiogenesis**; and (7) are often able to **evade apoptosis**. These properties are characteristic of cells of **malignant tumors**. It is metastasis that is generally responsible for the deaths of patients who have cancer. These points are summarized in **Figure 56–1**. By contrast, cells of **benign tumors** also show diminished control of growth, but do not invade local tissue or spread to other parts of the body. **Figure 56–2** shows a number of other important properties associated with cancer cells. These various points will be discussed below.

The **central issues in cancer** are to elucidate the biochemical and genetic mechanisms that underlie the uncontrolled growth of cancer cells, their ability to invade and metastasize and to develop successful treatments that destroy cancer cells, while causing minimal damage to normal cells. Considerable progress has been made in understanding the basic nature of cancer cells, and it is now generally accepted that though mutations in key genes contribute significantly to malignancies, particularly at the initiation phase of oncogenesis, other factors are also implicated in the development of malignant phenotypes. Organismal immunological status and tissue microenvironment are two such factors. Recent work has shown that the microenvironment of host and tumor cells,

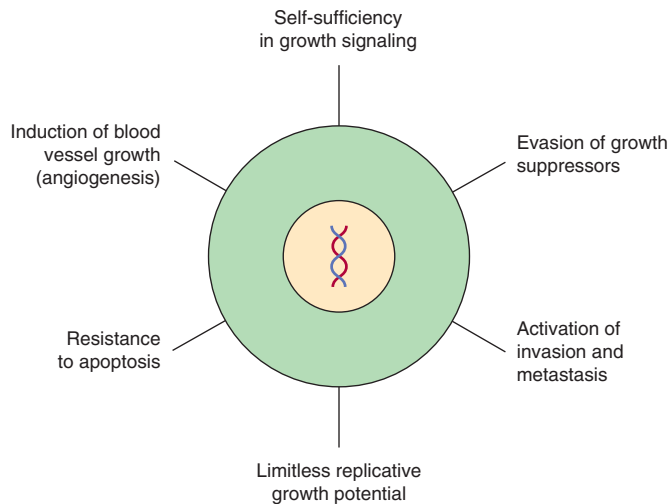

FIGURE 56-1 Six major features of cancer cells. Other important properties of cancer cells are shown in Figure 56-2. (After Hanahan D, Weinberg RA. The Hallmarks of Cancer: The next generation. *Cell* 2011; 144:646-674.)

and the interactions between them, has been demonstrated to contribute to the pathogenesis of malignancies. However, many aspects of the behavior of cancer cells, in particular their ability to metastasize, have yet to be fully explained.

In addition, despite improvements in treatment of certain types of cancers, therapies are still often unsuccessful. The study of cancer, or oncology, is a huge area, and thus this chapter will serve only to introduce the reader to key concepts of cancer biology.

A **glossary** at the end of this chapter defines the meanings of many of the terms used herein.

FUNDAMENTAL FEATURES OF CARCINOGENESIS

Non-lethal genetic damage is thought to be the initiating event in carcinogenesis. There are principally four classes of genes, which when mutated to cause gain-, or loss-of-function or inappropriate regulation, can result in the development of a tumor. These are **proto-oncogenes**, **tumor suppressor** genes, **DNA repair** genes, and genes regulating **apoptosis** or evasion of immune surveillance. Cancer is of **clonal origin**, with a single abnormal cell, often with multiple genetic alterations, multiplying to become a mass of cells forming a tumor. As mentioned earlier, the **tissue microenvironment influences the processes** that occur. The exact nature of these influences may vary with cell types involved, intercellular interactions and presence of factors such as paracrine signals, local hypoxia and proinflammatory responses. Carcinogenesis is, thus, a **multistep process**,

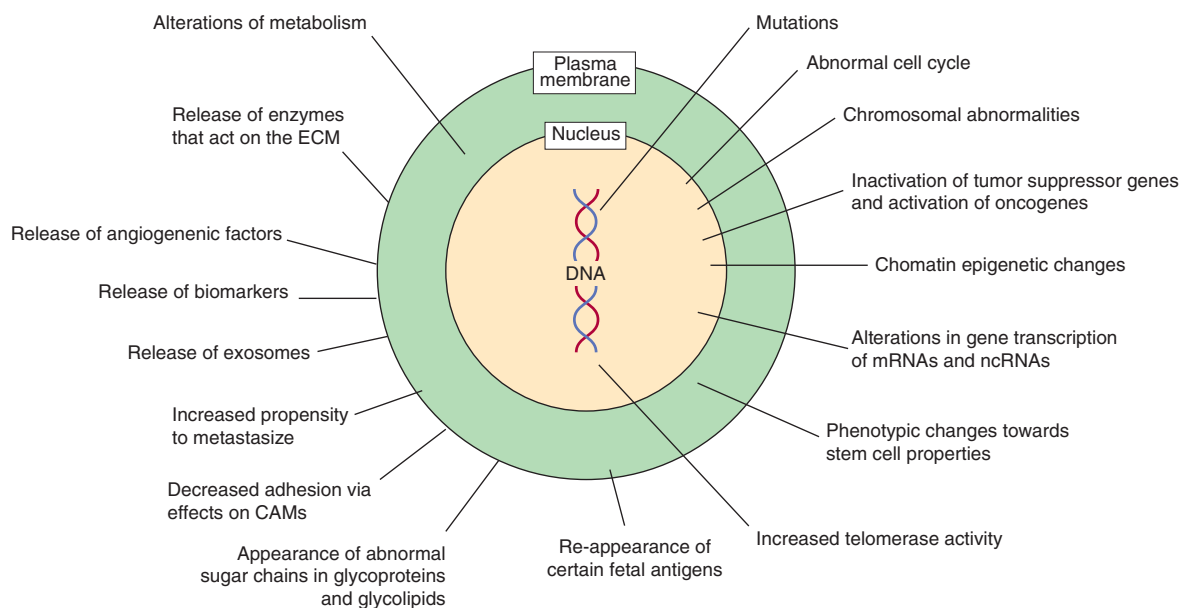

FIGURE 56-2 Some biochemical and genetic changes that occur in human cancer cells. Many changes, in addition to those indicated in Figure 56-1, are observed in cancer cells; only some of these are shown here. The roles of mutations in activating oncogenes and inactivating tumor suppressor genes are discussed in the text. Abnormalities of cell cycling and of chromosome and chromatin structure, including aneuploidy, are common. Alterations of expression of specific mRNAs and regulatory ncRNAs have been reported, and the relationship of stem cells to cancer cells is a very active area of research. Telomerase activity is often detectable in cancer cells. Tumors sometimes synthesize certain fetal antigens, which may be measurable in the blood. Changes in plasma membrane constituents (eg, alteration of the sugar chains of various glycoproteins—some of which are cell adhesion molecules—and glycolipids) have been detected in many studies, and may be of importance in relation to decreased cell adhesion and metastasis. Various molecules are released from cancer cells, in either soluble or membrane-bound vesicular forms, and can be detected in the blood or extracellular fluid; these include metabolites, lipids, carbohydrates, proteins and nucleic acids. Angiogenic factors and various proteinases are also released by some tumors. Many changes in metabolism have been observed; for example, cancer cells often exhibit a high rate of aerobic glycolysis. (CAM, cell adhesion molecule; ECM, extracellular matrix.)

ultimately transforming normal cells into malignant ones. Hence, tumors often take from a few to tens of years to develop to macroscopic levels.

CAUSES OF GENETIC DAMAGE

Genetic damage can be due to either acquired or inherited mutations. The former occur due to exposure to environmental carcinogens while the latter are hereditary. Such hereditary abnormalities result in a number of **familial conditions** that predispose to hereditary cancer. These mutations are found in specific genes (eg, tumor suppressor genes; DNA repair genes, etc) present in the germ cells, and are discussed later.

Spontaneous mutations, some of which may predispose to cancer, occur at a frequency of approximately 10^{-7} to 10^{-6} per cell per generation. This rate is greater in tissues undergoing a high rate of proliferation, a dynamic that can increase the generation of cancer cells from affected parent cells. **Oxidative stress** (see Chapter 45), generated by producing increased numbers of reactive oxygen species, may be a factor in increasing the mutation rate at the molecular level.

RADIANT ENERGY, CHEMICALS, AND CERTAIN VIRUSES ARE THE MAJOR KNOWN CAUSES OF CANCER

In general, there are three classes of carcinogens, exposure to which result in tumor formation. These are **radiant energy**, **chemicals**, and **certain oncogenic viruses** (see **Figure 56-3**). The first two cause mutations in DNA, and the third class generally acts by introducing novel genes into normal cells.

We shall only briefly describe how radiant energy, chemicals, and oncogenic viruses cause cancer.

Radiant Energy can be Carcinogenic

Ultraviolet rays, **x-rays**, and **γ -rays** are mutagenic and carcinogenic. Extensive studies have shown that these agents can damage DNA in a number of ways, including the lesions listed in **Table 56-1** (see also **Figure 35-22**). Mutations in DNA, due

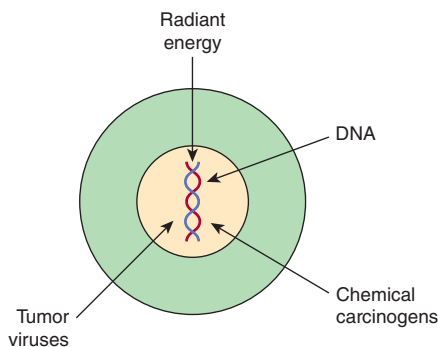

FIGURE 56-3 Radiant energy, chemical carcinogens and certain viruses can cause cancer by damaging chromosomal DNA.

TABLE 56-1 Some Types of DNA Damage Caused by Radiant Energy

to such damage, are thought to be the basic mechanism of carcinogenicity caused by radiant energy although the exact pathways are still under investigation. Additionally, x-rays and γ -rays can induce formation of reactive oxygen species (ROS) that are mutagenic and probably contribute to the carcinogenic effects of radiant energy.

Exposure to ultraviolet radiation is common due to exposure to sunlight, which is its main source. Ample evidence exists to show that such radiation is linked to cancers of the skin. The risk of developing a skin cancer due to ultraviolet radiation increases with increasing frequency and intensity of exposure and decreasing melanin content of skin.

As detailed in Chapter 35, DNA damage produced by environmental agents is usually removed by DNA repair mechanisms. Not surprisingly then, given the mutagenic nature of DNA damage, individuals who have an inherited inability to repair DNA have increased risk of developing a malignancy (see **Table 35-9**; **Chapter 57**).

Many Chemicals Are Carcinogenic

A wide variety of chemical compounds are carcinogenic (see **Table 56-2** and **Figure 56-4**). It is estimated that perhaps **80%** of human cancers are caused by environmental factors, principally chemicals.

Extensive studies have been performed in the field of chemical carcinogenesis. Overall, most **chemical carcinogens** are thought to **covalently modify DNA** thereby forming a wide range of **nucleotide adducts**. Depending on the extent

TABLE 56-2 Some Chemical Carcinogens

Class	Compound
Polycyclic aromatic hydrocarbons	Benzo[a]pyrene, dimethylbenzanthracene
Aromatic amines	2-Acetylaminofluorene, <i>N</i> -methyl-4-aminoazobenzene (MAB)
Nitrosamines	Dimethylnitrosamine, diethylnitrosamine
Various drugs	Alkylating agents (eg, cyclophosphamide), diethylstilbestrol
Naturally occurring compounds	Dactinomycin, aflatoxin B ₁

Note: As listed above, some drugs used as chemotherapeutic agents (eg, cyclophosphamide) can be carcinogenic. Diethylstilbestrol was formerly taken by women as an estrogenic agent; if they were pregnant, some of their daughters developed vaginal cancer.

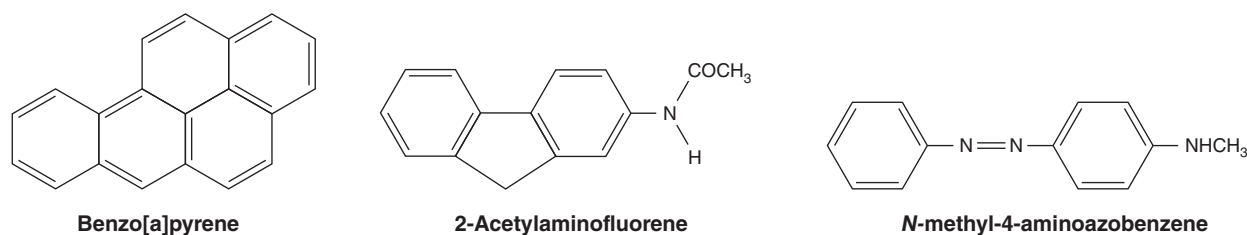

FIGURE 56-4 Structures of three experimentally widely used chemical carcinogens.

of damage to DNA and its repair by DNA repair systems (see Chapter 35), a variety of mutations in DNA can result from exposure of an animal or human to chemical carcinogens, some of which contribute to the development of cancer.

Some chemicals interact directly with DNA (eg, methchloroethamine and β -propiolactone), but others, termed **pro-carcinogens**, require conversion by enzyme action to become **ultimate carcinogens** (Figure 56-5). Most ultimate carcinogens are **electrophiles** (molecules deficient in electrons) and readily attack nucleophilic (electron-rich) groups in DNA. Conversion of chemicals to ultimate carcinogens is principally due to the actions of various species of **cytochrome P450** located in the endoplasmic reticulum (ER) (see Chapter 53). This fact is used in the Ames assay (see below), in which an aliquot of post-mitochondrial supernatant (containing ER) is added to the assay system as a source of cytochrome P450 enzymes.

Chemical carcinogenesis comprises two stages—initiation and promotion. Initiation is the stage where exposure to a chemical causes irreversible DNA damage and is a necessary initial event for a cell to become cancerous. Promotion comprises the stage at which an initiated cell begins to grow and proliferate abnormally. The cumulative effect of these stages is a neoplasm.

Chemical carcinogens can be identified by testing for their ability to induce mutations. A simple way to do this is by using the **Ames assay** (Figure 56-6). This relatively simple test, which detects mutations in *Salmonella typhimurium* caused by chemicals, has proven very valuable for screening purposes. A refinement of the Ames test is to add an aliquot of mammalian endoplasmic reticulum to the assay, to make it possible to identify pro-carcinogens. Very few, if any, compounds that have tested negative in the Ames test have been shown to cause tumors in animals. However, animal testing is required to show unambiguously that a chemical is carcinogenic.

It should be noted that compounds that alter epigenetic factors (such as DNA methylation and/or histone posttranslational modifications; see Chapter 38) that might predispose to

cancer, would not test positive in the Ames test, as they are not mutagenic.

Approximately 15% of Human Cancers May Be Caused by Viruses

The study of **tumor viruses** has contributed very significantly to the understanding of cancer. For example, discovery of both oncogenes and tumor suppressor genes (see below) emerged from studies of oncogenic viruses. Both DNA and RNA viruses have been identified as being able to cause cancers in humans (Table 56-3). The details of how each of these viruses causes cancer will not be described here. In general, the genetic material of viruses is incorporated into the genome of the host cell. In the case of RNA viruses, this would occur after reverse transcription of the viral RNA to viral DNA. Such integration of viral DNA (called the provirus) with the host DNA results in various events such as **deregulation of the cell**

A. Direct carcinogen \rightarrow DNA

Enzyme

B. Pro-carcinogen $\xrightarrow{\text{Enzyme}}$ Ultimate carcinogen \rightarrow DNA

FIGURE 56-5 (A) Direct and (B) indirect carcinogens. Direct carcinogens can interact with DNA without prior enzyme activation. Indirect carcinogens are activated by an enzyme (eg, a cytochrome P450 species) to the ultimate carcinogen and then interact with DNA.

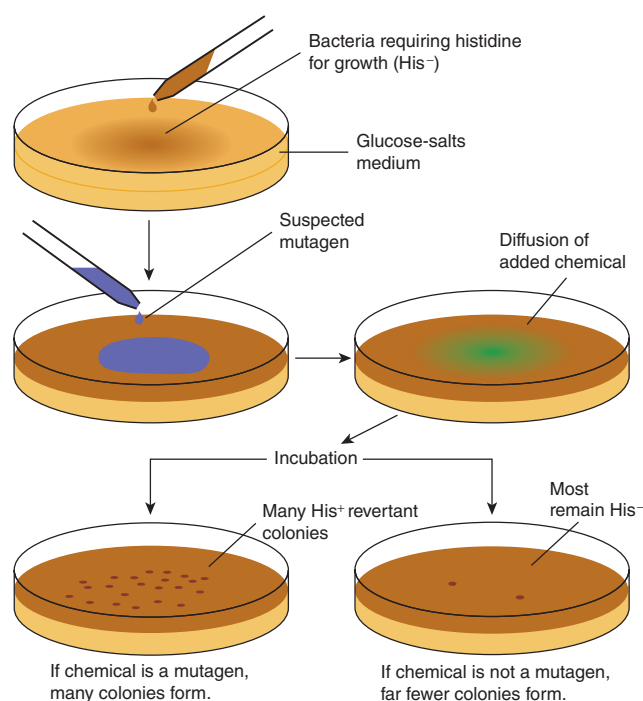

FIGURE 56-6 The Ames assay to screen for mutagens. The chemical tested will increase the frequency of reversion of His⁻ to His⁺ cells if it is a mutagen and, therefore, a potential carcinogen. A control plate (not shown) contains the solvent in which the suspected mutagen is dissolved. (Reproduced, with permission, from Nester EW, et al: *Microbiology: A Human Perspective*. 5th ed. McGraw-Hill, 2007.)

TABLE 56-3 Some Viruses That Cause or Are Associated With Human Cancers

Virus	Genome	Cancer
Epstein-Barr virus	DNA	Burkitt lymphoma, nasopharyngeal cancer, B cell lymphoma
Hepatitis B	DNA	Hepatocellular carcinoma
Hepatitis C	RNA	Hepatocellular carcinoma
Human herpesvirus type I	DNA	Kaposi sarcoma
Human papilloma viruses (certain types)	DNA	Cancer of the cervix
Human T-cell leukemia virus type 1	RNA	Adult T-cell leukemia

Note: It has been estimated that virus-linked human cancers are responsible for ~15% of total cancer incidence.

cycle, inhibition of apoptosis, and abnormalities of cell signaling pathways. All these events are discussed later in this chapter. **DNA viruses** often act by down regulating the expression and/or function of tumor suppressor genes *P53* and *RB* (see below) and their protein products. RNA viruses often carry oncogenes in their genomes; how oncogenes act to cause malignancy is discussed below.

ONCOGENES AND TUMOR SUPPRESSOR GENES PLAY KEY ROLES IN CAUSING CANCER

Over the past 30 years or so, major advances have been made in understanding how cancer cells develop and grow. Two key findings were the discoveries of **oncogenes** and **tumor suppressor genes**. These discoveries pointed to specific molecular mechanisms through which cell growth and division could be dysregulated, resulting in abnormal growth. The overall effects of oncogenes and loss of activity of tumor suppressor genes are summarized in **Figure 56-7**.

Proto-oncogenes → Oncogenes
 Tumor suppressor genes → Inactivated genes

→ ↑Growth rate → → → Cancer

FIGURE 56-7 Oncogenes and loss of activity of tumor suppressor genes drive cell growth toward cancer. Oncogenes encode various proteins that can drive the growth of cancer cells. Oncogenes are derived from proto-oncogenes. Tumor suppressor genes encode proteins that normally suppress cell growth, but which are inactivated when altered by mutations. MicroRNA molecules (not shown here) are also affected by mutations, and this can affect their normal regulatory functions. In addition, epigenetic changes (also not shown) affect gene expression, and hence growth of cancer cells.

Oncogenes Are Derived From Cellular Genes Termed Proto-oncogenes, and Encode a Wide Variety of Proteins That Affect Cell Growth & Cell Death

An **oncogene** can be defined as an altered gene whose product acts in a **dominant** manner to accelerate cell growth or cell division. Oncogenes are generated by “activation” of normal cellular **proto-oncogenes**; that is, genes encoding growth stimulating proteins. Such activation can be effected through any of several different mechanisms (**Table 56-4**).

Table 56-4 lists an example of a point mutation occurring in the *RAS* oncogene. *RAS* encodes a small GTPase. Loss of the GTPase activity of this G protein results in chronic stimulation of the activity of adenylyl cyclase, leading to cell proliferation (recall that G-proteins are active when complexed with GTP and inactive when the bound GTP is hydrolyzed to GDP; see Chapter 42). Another way an oncogene can be activated is via insertion of an enhancer and/or strong promoter upstream of a protein coding region resulting in increased transcription and hence protein expression of the cognate gene. Shown in **Figure 56-8A** is an example where integration of a retroviral provirus enhancer/promoter (ie, the reverse transcriptase-generated DNA copy of the RNA genome of a tumor virus such as Rous sarcoma virus) activates *MYC*, a neighboring host gene. Overproduction of the transcription factor *myc* activates the transcription of cell cycle regulatory genes and hence stimulates cell proliferation. **Chromosomal translocations** are found quite frequently in cancer cells; literally hundreds of different examples have been documented. The translocation found in cases of Burkitt lymphoma is illustrated in **Figure 56-8B**. The overall effect of this translocation is also to activate *MYC* gene expression, again resulting in cell proliferation. Yet another

TABLE 56-4 Mechanisms of Activating Oncogenes

Mechanism	Explanation
Mutation	A classic example is point mutation of the <i>RAS</i> oncogene. This results in the gene product, a small GTPase, having less activity in tumors and in resultant stimulation of the activity of adenylyl cyclase.
Promoter insertion	Insertion of a viral promoter region near a gene activates it.
Enhancer insertion	Insertion of a viral enhancer region near a gene activates it.
Chromosomal translocation	The basis is that a piece of one chromosome is split off and joined to another. Classic examples are these involved in Burkitt lymphoma (see Figure 56-8) and in the Philadelphia chromosome (see the Glossary).
Gene amplification ^a	Abnormal multiplication of a gene occurs, resulting in many copies. This can occur with oncogenes and also genes involved in tumor drug resistance.

^aGene amplification may be recognized as homogeneously stained regions on chromosomes, or as double minute chromosomes.

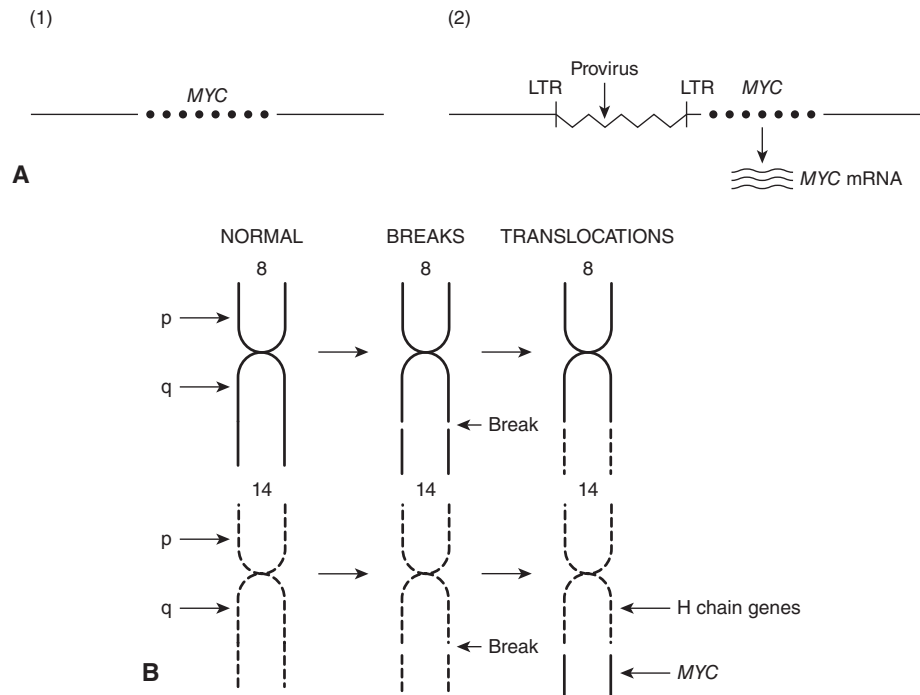

FIGURE 56-8 (A) Schematic representation of how promoter insertion may activate a proto-oncogene. (1) Normal chicken chromosome showing an inactive *MYC* gene. (2) An avian leukemia virus has integrated in the chromosome in its proviral form (a DNA copy of its RNA genome) adjacent to the *MYC* gene. Its right-hand long terminal repeat (LTR), containing a strong promoter (see Chapter 36), lies just upstream of the *MYC* gene and activates that gene, resulting in transcription of *MYC* mRNA. For simplicity, only one strand of DNA is depicted and other details have been omitted. Enhancer insertion acts similarly, except that the site of integration may be downstream or considerably upstream, and it cannot act as a promoter. Instead, a specific proviral sequence acts as an enhancer element (see Chapter 36), leading to activation of the *MYC* gene and its transcription. **(B) Schematic representation of the reciprocal translocation involved in Burkitt lymphoma.** The chromosomes involved are 8 and 14. A segment from the end of the q arm of chromosome 8 breaks off and moves to chromosome 14. The reverse process moves a small segment from the q arm of chromosome 14 to chromosome 8. The *MYC* gene is contained in the small piece of chromosome 8 that was transferred to chromosome 14; it is thus placed next to genes transcribing the heavy chains of immunoglobulin molecules, and itself becomes activated. Many other translocations have been identified, with perhaps the best known being that involved in formation of the Philadelphia chromosome (see the glossary).

mechanism of oncogene activation is via **gene amplification** (see Chapter 38), a process that occurs quite commonly in various cancers. In this case, multiple copies of an oncogene are formed, which results in increased production of a growth-promoting protein.

Activated oncogenes promote cancer through a variety of mechanisms as depicted in **Figure 56-9**. The protein products of activated oncogenes affect cell-signaling pathways, where they may act as a growth factor, a growth factor receptor, a G-protein or as a downstream signaling molecule. Other oncoproteins act to alter transcription or to deregulate the cell cycle. Still other oncoproteins affect cell-cell interactions, or the process of apoptosis. Collectively these mechanisms help to explain many of the major features of cancer cells shown in **Figure 56-1**, such as their limitless replicative potential, their constitutively activated signaling pathways, their ability to invade and spread, and their evasion of apoptosis.

Certain **tumor viruses** (eg, retroviruses, papovaviruses) **contain oncogenes**. It was the study of such tumor viruses (eg, Rous sarcoma virus [RSV], a retrovirus) that first revealed the presence of oncogenes. Further study showed that many retroviral oncogenes were derived from normal cellular genes, the so-called proto-oncogenes, which the tumor viruses had picked up during their passage through host cells.

Tumor Suppressor Genes Act to Inhibit Cell Growth & Division

A **tumor suppressor gene** produces a protein product that normally suppresses cell growth or cell division. When such a gene is altered by mutation, the inhibitory effect of its product is lost or diminished. This loss of tumor suppressor gene function leads to increased cell growth or cell division. As first suggested by AG Knudson, based on studies of the inheritance of

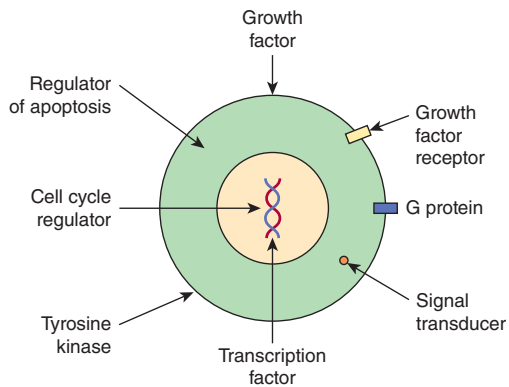

FIGURE 56-9 Examples of ways by which oncoproteins work. Shown are examples of various proteins encoded by oncogenes (oncoproteins). The proteins are listed below with the corresponding oncogene given in parentheses along with its OMIM number. A growth factor, fibroblast growth factor 3 (*INT2*, 164950); a growth factor receptor, epidermal growth factor receptor [EGFR] (*HER1*, 131550); a G protein (*H-RAS-1*, 190020); a signal transducer (*BRAF*, 164757); a transcription factor (*MYC*, 190080); a tyrosine kinase and involved in cell-cell adhesion (*SRC*, 190090); a cell cycle regulator (*PRAD*, 168461); a regulator of apoptosis (*BCL2*, 151430).

retinoblastomas, both copies of a tumor suppressor gene must be affected for it to lose its inhibitory effects on growth (ie, a mutated loss-of-function allele, *rb*⁻, is recessive to a wild type *RB* copy of the gene).

A useful distinction has been made between **gatekeeper** and **caretaker** functions of tumor suppressor genes. Gatekeeper genes (products) control cell proliferation, and include mainly genes that act to regulate the cell cycle and apoptosis. By contrast, caretaker gene products are concerned with preserving the integrity of the genome, and include genes whose products are involved in recognizing and correcting DNA damage and maintaining chromosomal integrity during cell division. Many oncogenes and tumor suppressor genes have now been identified. Only a few are mentioned here. The most important differences between oncogenes and tumor suppressor genes are listed in Table 56-5. Table 56-6 lists some of the properties of two of the most intensively studied oncogenes

TABLE 56-5 Some Differences Between Oncogenes and Tumor Suppressor Genes

Oncogenes	Tumor Suppressor Genes
Mutation in one of the two alleles is sufficient	Both alleles must be affected
Gain of function of a protein that signals cell division	Loss of function of a protein
Mutation arises in somatic cells, not inherited	Mutation present in germ cell (can be inherited), or in somatic cell
Some tissue preference	Often strong tissue preference (eg, effect of <i>RB</i> gene in the retina)

Source: Data from Levine AJ: The p53 tumor suppressor gene. *N Engl J Med* 1992;326:1350.

TABLE 56-6 Some Properties of a Few Important Oncogenes and Tumor Suppressor Genes

Name	Properties
<i>MYC</i>	An oncogene (OMIM 190080) that encodes a DNA-binding transcription factor, p53, that can alter transcription. Involved in cell growth, cell cycle progression, and DNA replication. Mutated in a variety of tumors.
<i>P53</i>	A tumor suppressor gene (OMIM 191170) that responds to various cellular stresses. It induces cell cycle arrest, apoptosis, senescence, DNA repair and is involved in some aspects of regulation of cellular metabolism. It has been named “the guardian of the genome.” Mutated in some 50% of human tumors. The nomenclature p53 refers to the approximate molecular mass of the protein encoded by <i>P53</i> , as calculated from SDS-PAGE.
<i>RAS</i>	A family of oncogenes encoding small GTPases. They were initially identified as being the transforming genes of certain murine sarcoma viruses. Important members of the family are K-RAS (Kirsten), H-RAS (Harvey) (OMIM 190020), and N-RAS (neuroblastoma). Persistent activation of these genes due to mutations contributes to the development of a variety of cancers.
<i>RB</i>	A tumor suppressor gene (OMIM 180200) encoding the RB protein. RB regulates the cell cycle by binding the elongation factor E2F. It represses the transcription of various genes involved in the S phase of the cycle. Mutation of the <i>RB</i> gene is the cause of retinoblastoma, but it is also involved in the genesis of certain other tumors (see Chapter 35).

(*MYC* and *RAS*), and two of the most highly studied tumor suppressor genes (*P53* and *RB*).

miRNAs Are Key players in Carcinogenesis and Tumor Metastasis

Micro RNAs (miRNAs) are short single-stranded RNA molecules that can regulate transcription and/or translation of protein-coding genes (see Chapter 34 for details). They are now known to play multiple roles in every aspect of tumor formation and progression. Some miRNAs are tumor suppressors and can act by degrading RNA coding for oncogenic proteins, thus decreasing their expression. These miRNAs are found to be downregulated in a number of different types of cancer. On the other hand, some miRNAs are oncogenic in nature. For example, miR-21, one of the most widely studied oncogenic miRNAs, has been found to be upregulated to varying extents in almost all types of cancer. Other miRNAs play key roles in activating or inhibiting metastasis. Research in recent years has focused on developing drugs that target miRNA.

Studies of the Development of Colorectal Cancers Have Illuminated the Involvements of Specific Oncogenes and Tumor Suppressor Genes

Many types of tumors have been analyzed for genetic changes. One of the most informative areas in this respect has been analysis of the **development of colorectal cancer** by Vogelstein

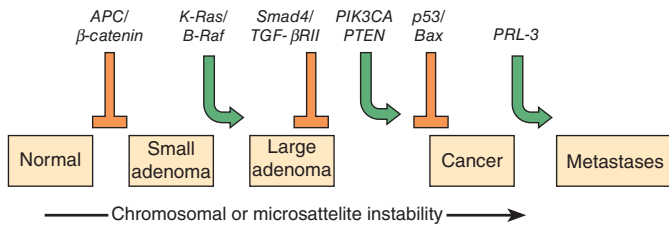

FIGURE 56–10 Multistep genetic changes associated with the development of colorectal cancers. Mutations in the *APC* gene initiate the formation of adenomas. One sequence of mutations in an oncogene and in various tumor suppressor genes that can result in further progression to large adenomas and cancer is indicated. Patients with familial adenomatous polyposis (OMIM 175100) inherit mutations in the *APC* gene and develop numerous dysplastic aberrant crypt foci (ACF), some of which progress as they acquire the other mutations indicated in the figure. The tumors from patients with hereditary nonpolyposis colon cancer (OMIM 120435) go through a similar, though not identical, series of mutations; mutations in the mismatch repair system (see Chapter 35) speed up this process. *K-RAS* is an oncogene, and the other specific genes indicated are tumor suppressor genes. The sequence of events shown here is not invariable in the development of all colorectal cancers. A variety of other genetic alterations have been described in a small fraction of advanced colorectal cancers. These may be responsible for the heterogeneity of biological and clinical properties observed among different cases. Instability of chromosomes and microsatellites (see Chapter 35) occurs in many tumors, and likely involves mutations in a considerable number of genes. (Reproduced, with permission, from Bunz F, Kinzler KW, Vogelstein B: Colorectal tumors, Fig. 48-2, *The Online Metabolic & Molecular Bases of Inherited Disease*, www.ommbid.com)

and colleagues. Their work, and that of others, has shown the involvement of various oncogenes and tumor suppressor genes in human cancer. (Case 4 in Chapter 57 describes the history of a patient with colorectal cancer). These workers analyzed various oncogenes, tumor suppressor genes, and certain other relevant genes in samples of **normal colonic epithelium**, of **dysplastic epithelium** (a preneoplastic condition, characterized by abnormal development of epithelium), of various stages of **adenomatous polyps**, and of **adenocarcinomas**. Some of their major findings are summarized in **Figure 56–10**. It can be seen that certain genes were mutated at relatively specific stages of the total sequence shown. Functions of the various genes identified are listed in **Table 56–7**. The overall sequence of changes can vary somewhat from that shown and other genes may also be involved. Similar studies have been performed on a number of other human tumors revealing somewhat different patterns of activation of oncogenes and mutations of tumor suppressor genes. Further mutations in these and other genes are involved in **tumor progression**, a phenomenon whereby clones of tumor cells become selected for fast growth rate and ability to metastasize. Thus, a relatively large tumor may contain a variety of cells with different genotypes, making successful treatment more difficult. Finally it is important to recognize that tumor microenvironment also contributes to these processes, though their exact role in colorectal cancer (and other types of highly studied cancers) remains to be elucidated.

TABLE 56–7 Some Genes Associated With Colorectal Carcinogenesis

Gene ^a	Action of Encoded Protein
<i>APC</i> (OMIM 611731)	Antagonizes WNT ^b signaling; if mutated, WNT signaling is enhanced, stimulating cell growth
β -CATENIN (OMIM 116806)	Encodes β -catenin, a protein present in adherens junctions, which are important in the integrity of epithelial tissues
<i>K-RAS</i> (OMIM 601599)	Involved in tyrosine kinase signaling
<i>BRAF</i> (OMIM 164757)	A serine/threonine kinase
<i>SMAD4</i> (OMIM 600993)	Affects signaling by transforming growth factor-beta (TGF- β)
<i>TGF-βRII</i>	Acts as a receptor for TGF- β ^c
<i>PI3KCA</i> (OMIM 171834)	Acts as a catalytic subunit of phosphatidylinositol 3-kinase
<i>PTEN</i> (OMIM 601728)	A protein tyrosine phosphatase with an area of homology to tensin, a protein that interacts with actin filaments at focal adhesions
<i>P53</i> (OMIM 191170)	The product, p53, is induced in response to DNA damage and is also a transcription factor for many genes involved in cell division (see Chapter 35, Table 56–10)
<i>BAX</i> (OMIM 600040)	Acts to induce cell death (apoptosis)
<i>PRL3</i> (OMIM 606449)	A protein-tyrosine phosphatase

Abbreviations: *APC*, adenomatous polyposis coli gene; *BAX*, encodes BCL2-associated X protein (BCL2 is a repressor of apoptosis); *BRAF*, the human homolog of an avian proto-oncogene; *K-RAS*, Kirsten-Ras-associated gene; *PI3KCA*, encodes the catalytic subunit of phosphatidylinositol 3-kinase; *PRL3*, encodes a protein-tyrosine phosphatase with homology to PRL1, another protein-tyrosine phosphatase found in regenerating liver; *PTEN*, encodes a protein-tyrosine phosphatase and tensin homolog; *P53*, encodes p53, a polypeptide of molecular mass ~53 kDa; *SMAD4*, the homolog of a gene found in *Drosophila*.

^a*K-RAS* and *BRAF* are oncogenes; the other genes listed are either tumor suppressor genes or genes whose products are associated with the actions of the products of tumor suppressor genes.

^bThe WNT family of secreted glycoproteins is involved in a variety of developmental processes. Tensin is a protein that interacts with actin filaments at focal adhesions.

^cTGF- β is a polypeptide (a growth factor) that regulates proliferation and differentiation in many cell types.

Note: The various genes listed are either oncogenes, tumor suppressor genes or genes whose products are closely associated with the products of these two types of genes. The cumulative effects of mutations in the genes listed are to drive colonic epithelial cells to proliferate and eventually become cancerous. They achieve this mainly via effects on various signaling pathways affecting cellular proliferation. Other genes and proteins not listed here are also involved. This table and Figure 56–10 vividly show the importance of a detailed knowledge of cell signaling for understanding the genesis of cancer.

Several other conclusions can be drawn from these results and those from other similar studies. First, cancer is truly a genetic disease, but in a somewhat different sense from the normal meaning of the phrase, insofar as many of the gene alterations are due to somatic mutations. Second, carcinogenesis is a multistep process. It is estimated that in most cases a minimum of five to six genes must be mutated for cancer to occur. Third, additional subsequent mutations are thought to confer selective advantages on clones of cells, some of which acquire

the ability to metastasize successfully (see below). Finally, many of the genes implicated in colorectal carcinogenesis and other types of cancers are involved in cell signaling events, showing again the central role that alterations in signaling play in the development of cancer.

GROWTH FACTORS & ABNORMALITIES OF THEIR RECEPTORS & SIGNALING PATHWAYS PLAY MAJOR ROLES IN CANCER DEVELOPMENT

There Are Many Growth Factors

A large variety of polypeptide growth factors that work on human tissues and cells have been identified. Some are listed in **Table 56–8**. Here we focus mostly on their relationship with cancer.

Growth factors can act in an **endocrine**, **paracrine**, or **autocrine** manner and affect a wide variety of cells to produce a **mitogenic response**. As described earlier (Chapter 53), growth factors play important roles in the differentiation of hematopoietic cells.

Growth inhibitory factors also exist. For example, transforming factor beta (TGF- β) exerts inhibitory effects on the growth of certain cells. Thus, chronic exposure to either increased amounts of a growth factor, or to decreased amounts of a growth inhibitory factor, can alter the balance of cellular growth.

TABLE 56–8 Some Polypeptide Growth Factors

Growth Factor	Function
Epidermal growth factor (EGF)	Stimulates growth of many epidermal and epithelial cells
Erythropoietin (EPO)	Regulates development of early erythropoietic cells
Fibroblast growth factors (FGFs)	Promote proliferation of many different cells
Interleukins	Interleukins exert a variety of effects on cells of the immune system
Nerve growth factor (NGF)	Trophic effect on certain neurons
Platelet-derived growth factor (PDGF)	Stimulates growth of mesenchymal and glial cells
Transforming growth factor-alpha (TGF α)	Similar to EGF
Transforming growth factor-beta (TGF β)	Exerts both stimulatory and inhibitory effects on certain cells

Note: Many other growth factors have been identified. Growth factors may be made by a variety of cells, or may have mainly one source. Many different interleukins have now been isolated; along with the interferons and some other proteins/polypeptides, they are referred to as cytokines.

Growth Factors Work via Specific Receptors & Transmembrane Signaling to Affect the Activities of Specific Genes

Growth factors produce their effects by interacting with **specific receptors** on cell surfaces, initiating **various signaling events** (Chapter 42). Genes encoding receptors for growth factors have been identified and characterized. They generally have short membrane-spanning segments and external and cytoplasmic domains. A number (eg, those for epidermal growth factor [EGF], insulin and platelet-derived growth factor [PDGF]) have **tyrosine kinase** activity. The kinase activity, located in the cytoplasmic domains, causes autophosphorylation of the receptor protein and also phosphorylates certain other proteins.

Consideration of how **PDGF** acts illustrates how one particular growth factor brings about its effects. Interaction of PDGF with its receptor stimulates the activity of phospholipase C (PLC). PLC splits phosphatidylinositol bisphosphate (PIP₂) into inositol trisphosphate (IP₃) and diacylglycerol (DAG) (see Figure 42–6). Increased IP₃ stimulates the release of intracellular Ca²⁺ and DAG activates protein kinase C (PKC). Hydrolysis of DAG may release arachidonic acid, which can stimulate production of prostaglandins and leukotrienes, each of which has various biologic effects. Exposure of target cells to PDGF can result in rapid (minutes to 1–2 h) activation of certain cellular proto-oncogenes (eg, *MYC* and *FOS*) that participate in stimulation of mitosis via effects on the cell cycle (see below). The bottom line is that growth factors interact with specific receptors to stimulate specific signaling pathways that serve to increase or decrease the activities of various genes that affect cell division.

MANY CANCERS CAN BE PREVENTED BY MODIFYING RISK FACTORS

Modifiable risk factors have been linked to a wide variety of cancers. It has been estimated that over half of all cancers in developed countries could be prevented if the measures summarized in **Table 56–9** were introduced on a population-wide basis. **Smoking** is still a major cause of cancer across the globe. It cannot be overemphasized that **prevention** and **early detection of cancer** are most critical if the disease is to be beaten.

ABNORMALITIES OF THE CELL CYCLE ARE UBIQUITOUS IN CANCER CELLS

Knowledge of **the cell cycle** is necessary for understanding many of the mechanisms involved in the development of cancer. It is also of importance because many anti-cancer drugs act only against cells that are dividing, or in a certain phase of the cycle.

TABLE 56–9 Measures That Might Prevent Approximately 50% of Cancers if Introduced on a Population-Wide Basis

• Reduce tobacco use
• Increase physical activity
• Control weight
• Improve diet
• Limit alcohol
• Use safer sex practices
• Routine cancer screening tests
• Avoid excess exposure to the sun

Source: Data from Stein CJ, Colditz GA: Modifiable risk factors for cancer. *Brit J Cancer* 2004;90:299.

Basic aspects of the cell cycle were described in Chapter 35. As shown in Figure 35–20, the cycle has four phases: G_1 , S, G_2 , and M. If cells are not cycling, they are said to be in G_0 phase and are termed quiescent. Cells can be recruited into the cycle from G_0 by various influences (eg, certain growth factors). Generation time is the time needed for a cell in G_0 to enter the cycle and give rise to two daughter cells. The cells of a cancer usually have a shorter generation time than normal cells, and there are less of them in G_0 phase.

The roles of various **cyclins**, **cyclin-dependent kinases (CDKs)**, and a number of other important molecules that affect the cell cycle (eg, the genes *RB* and *P53*) were also described in Chapter 35. The points in the cycle at which some of these molecules act are indicated in Figure 35–21 and Table 35–7.

Because a major property of cancer cells is uncontrolled growth, many aspects of their cell cycle have been studied in considerable depth. Only a few results can be mentioned here. A variety of mutations that affect cyclins and CDKs have been reported. Many products of proto-oncogenes and tumor suppressor genes play important roles in regulating the normal cycle. A wide variety of mutations have been found in these types of genes, including *RAS*, *MYC*, *RB*, *P53* (which are among the most studied, see below) and many others.

For example, as discussed in Chapter 35, the protein product of the *RB* gene is a cell cycle regulator. It acts via binding to the transcription factor E2F, blocking progression of the cell from G_1 to S phase. Loss of the RB protein due to mutations thus removes this element of control of the cell cycle.

When damage to DNA occurs (by radiation or chemicals), the p53 protein increases in amount and activates transcription of genes that delay transit through the cycle. If the damage is too severe to repair, p53 activates genes that cause apoptosis (see below). If p53 is absent or inactive due to mutation, apoptosis does not occur and cells with damaged DNA persist, perhaps becoming progenitors of cancer cells.

GENOMIC INSTABILITY AND ANEUPLOIDY ARE IMPORTANT CHARACTERISTICS OF CANCER CELLS

As referred to above and also later in this chapter, cancer cells have many mutations. One possible explanation for their **genomic instability** is that they have a **mutator phenotype**. The idea of mutator phenotypes was originally postulated by Loeb and colleagues, who argued they were caused by cancer cells having acquired mutations in genes involved in DNA replication and DNA repair thus, allowing mutations to accumulate. The concept was later expanded to include mutations that affect chromosomal segregation, DNA damage surveillance, and processes such as apoptosis.

The term genomic instability is frequently used to refer to two abnormalities shown by many cancer cells, **microsatellite** and **chromosomal instability (CIN)**. **Microsatellite instability** was described briefly in Chapter 35. It involves expansion or contraction of microsatellites, usually due to abnormalities of mismatch repair, or to replication slippage. CIN occurs more often than microsatellite instability, and the two are often mutually exclusive. CIN refers to gain or loss of chromosomes caused by abnormalities of chromosomal segregation during mitosis.

Another area of interest regarding CIN is **copy number variation (CNV)** (see the Glossary). Associations of various CNVs with many cancers have been identified, and their precise roles in cancer are under investigation.

An important aspect of CIN is **aneuploidy**, a very common feature of solid tumors. Aneuploidy exists when the chromosomal number of a cell is not a multiple of the haploid number. The degree of aneuploidy often correlates with a poor prognosis. This has suggested that abnormalities of chromosomal segregation may contribute to tumor progression by increasing genetic diversity. Some scientists believe that aneuploidy is a fundamental aspect of cancer.

Much research is aimed at determining the basis of CIN and aneuploidy. As shown in **Figure 56–11**, a number of different

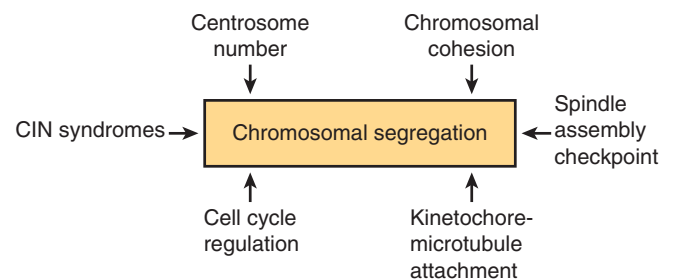

FIGURE 56–11 Factors involved in chromosomal segregation, which are relevant to understanding chromosomal instability (CIN) and aneuploidy. CIN syndromes include Bloom syndrome (OMIM 210900) and others. (Based on Thompson SL, et al: Mechanisms of chromosomal instability. *Curr Biol* 2010;20(6):R285.)

processes are involved in normal chromosomal segregation. Each process is complex, and involves various organelles and many individual proteins. A textbook of Cell Biology should be consulted for details of the process of chromosomal segregation and cell division. Studies are in progress to compare these processes in normal and tumor cells, and to determine which of the differences detected may be contributors to CIN and aneuploidy. One hope of this line of research is that it might be possible to develop drugs that diminish or even prevent CIN and aneuploidy.

MANY CANCER CELLS DISPLAY ELEVATED LEVELS OF TELOMERASE ACTIVITY

There has been considerable interest in the involvement of telomeres (see Chapter 35) in a number of diseases and also in aging. With respect to cancer, when tumor cells divide rapidly their telomeres often shorten. Such telomeres (usually detected in leukocytes because of ease of obtaining them) have been implicated as a risk factor for many, but not all, solid tumors (eg, breast cancer). **Short telomeres** appear to be of predictive value regarding the progression of chronic inflammatory diseases (such as ulcerative colitis and Barrett esophagus) to cancer. Abnormalities of telomere structure and function can contribute to CIN (see above). The activity of **telomerase**, the main enzyme involved in synthesizing telomeres, is frequently elevated in cancer cells, providing one mechanism for overcoming telomere shortening. Selective inhibitors of telomerase have been considered as possible drugs for treating cancer, but have not as yet been translated into successful clinical use.

A NUMBER OF CANCERS HAVE A HEREDITARY PREDISPOSITION

It has been known for many years that certain cancers have a hereditary basis. It is estimated that about 5% of cancers fall into this category. The discovery of oncogenes and tumor suppressor genes has allowed investigations of the basis of this phenomenon. Many hereditary types of cancer have now been recognized; only a few of these are listed in **Table 56–10**. In a number of cases, where a hereditary syndrome is suspected, appropriate genetic screening of families has allowed early interventions to be made. For example, some young women who have inherited either a mutated *BRCA1* or *BRCA2* gene have opted for prophylactic mastectomies to prevent cancer of the breast occurring in later life.

WHOLE GENOME & EXOME SEQUENCING OF TUMOR CELLS IS PROVIDING NEW INSIGHTS REGARDING CANCER

Since the completion of the Human Genome Project some 10 years ago, the technology of large-scale DNA sequencing and bioinformatic analyses and interpretation of sequence data has advanced considerably. Large-scale DNA sequencing has become both faster and cheaper. These advances have allowed for large-scale analyses of the DNA sequences of a large number of different types of tumors. This task is being tackled in two ways. The first is sequencing of entire genomes and the second is sequencing the complete exomes (Chapter 39) of

TABLE 56–10 Some Hereditary Cancer Conditions

Condition	Gene	Major Function	Major Clinical Feature
Adenomatous polyposis of the colon (OMIM 175100)	<i>APC</i>	See Table 56–7	Development of many early-onset adenomatous polyps, which are immediate precursors of colorectal cancers
Breast cancer 1, early onset (OMIM 113705)	<i>BRCA1</i>	DNA repair	About 5% of women in N America with breast cancer carry mutations in this gene or in <i>BRCA2</i> . Also substantially increases risk of ovarian cancer
Breast cancer 2, early onset (OMIM 600185)	<i>BRCA2</i>	DNA repair	As stated above for <i>BRCA1</i> . Mutations in this gene also increase the risk of ovarian cancer, but to a lesser extent
Hereditary nonpolyposis cancer, type I (OMIM 120435)	<i>MSH2</i>	DNA mismatch repair	Early onset of colorectal cancers
Li-Fraumeni syndrome (OMIM 151623)	<i>P53</i>	See Table 56–6	A rare syndrome involving cancers at different sites, developing at an early age
Neurofibromatosis, type 1 (OMIM 162200)	<i>NF1</i>	Encodes neurofibromin	Varies from a few café au lait spots to development of thousands of neurofibromas
Retinoblastoma (MIM 180200)	<i>RB1</i>	See Table 56–6	Hereditary or sporadic retinoblastoma ^a

^aIn hereditary retinoblastoma, one allele is mutated in the germ line, requiring only one subsequent mutation for a tumor to form. In sporadic retinoblastoma, neither allele is mutated at birth, so that subsequent mutations in both alleles are required. Many other hereditary cancer conditions have also been identified.

different tumor types, along with their cognate normal tissues. In this way, **comprehensive catalogs** of specific types and numbers of **gene mutations** found in different cancers can be determined. Such information will ultimately revolutionize **diagnostic testing** and the development of **custom-tailored therapy**. A recent study analyzed the sequence of the exomes of ~5000 human cancers across 21 different tumor types, along with normal tissue controls. Since very few genes are mutated at near universal levels like *P53*, it is important to identify those cancer genes that are mutated at lower frequencies, yet still contribute significantly to oncogenesis. By sequencing these 5000 tumor/normal pair exomes for 21 tumor types, and performing statistical analysis of the resulting data, 33 previously unknown cancer-associated genes were identified. The proteins encoded by these 33 new genes are related to genome stability, epigenetic/chromatin gene regulation, immune evasion, proliferation, apoptosis, RNA processing, and protein homeostasis—results consistent with roles of these proteins in malignant transformation (Figures 56–1 and 56–2). More detailed statistical analysis of the data indicate that near-complete identification of cancer genes, by exome sequencing, can be attained with 600 to 5000 samples of any given tumor type. The absolute number of samples analyzed will be dependent on the intrinsic mutation rate in a particular tumor type; an attribute that can vary dramatically, as other studies have shown. It will be of particular interest to identify mutations in genes that cause and accelerate cancers; these are known as **driver** mutations, whereas other mutations are called **passenger** mutations. It is expected that this new information will dramatically impact the next stages of cancer genomics and, ultimately, diagnosis and therapy.

Another fascinating example of the information that can be generated by genome sequencing is provided by the results of a recent study of pancreatic carcinomas. These are among the most deadly cancers. However, an issue that had not been resolved is whether their lethality is due to their aggressiveness (ie, ability to grow, invade and metastasize), or to late diagnosis. In the study under consideration, the genomes of seven primary pancreatic cancers were sequenced, as were the genomes of metastases from them obtained at autopsy. Approximately 61 known cancer-related mutations were detected in each metastasis. Using a “molecular clock” technique borrowed from evolutionary biology, it was calculated how long it took the metastases to accumulate these mutations. Prior knowledge of the overall sequence of mutations made this possible. It was estimated that it took just over 10 years from the time of the initiating mutation for nonmetastatic primary tumors to develop in the pancreas. Another 5 years was required for such tumors to gain metastatic potential. Thereafter, about 2 years elapsed before the tumors metastasized and death resulted. Thus, it was suggested that the evolution of many pancreatic cancers is a relatively slow process, and that pancreatic cancers are not highly aggressive. The problem is that they are difficult to diagnose. The hope is that methods such as detection of mutations in pancreatic cancer cells present in stool specimens, development of new blood biomarkers for pancreatic cancers,

and perhaps new imaging techniques will allow early diagnosis, always a critical factor in the management of cancer.

CANCER CELLS HAVE ABNORMALITIES OF APOPTOSIS THAT PROLONG THEIR PROLIFERATIVE CAPACITY

Apoptosis is a genetically regulated program that, when activated, **causes cell death**. The main proteins involved in apoptosis are proteolytic enzymes named **caspases**, which normally exist as inactive **procaspases**. The name caspase reflects that they are cysteine proteases that split peptide bonds on the C-terminal end of aspartate residues. About 15 human caspases are known, although not all participate in apoptosis. When those involved in apoptosis are activated (mainly 2, 3, 6, 7, 8, 9, and 10), they participate in a **cascade** of events (compare with the coagulation cascade, Chapter 51) that ultimately kills cells by digesting various proteins and other molecules. The **upstream caspases** (eg, 2, 8, and 10) at the beginning of the cascade are often called **initiators**, and those downstream at the end of the pathway (eg, 3, 6, and 7) are called **effectors** or **executioners**. **Caspase-activated DNase (CAD)** fragments DNA, producing a characteristic laddering pattern detected by gel electrophoresis. Microscopic features of apoptosis include condensation of chromatin, changes of nuclear shape and membrane blebbing. The dead cells are rapidly disposed of by phagocytic activity, avoiding an inflammatory reaction.

Apoptosis differs from **necrosis**, a pathologic form of cell death that is not genetically programmed. Necrosis occurs on exposure to external agents, such as certain chemicals and extreme heat (eg, burns). Various hydrolytic enzymes (proteases, phospholipases, nucleases, etc) are involved in necrosis. Release of cell contents from dying cells can cause local inflammation, unlike apoptosis.

The overall process of apoptosis is complex and it is tightly regulated. It includes proteins that act as receptors and, adapters, procaspases and caspases, and pro- and antiapoptotic factors. There are **extrinsic** and **intrinsic pathways**, with **mitochondria** being important participants in the intrinsic pathway.

Figure 56–12 shows a simplified diagram of some of the key events in apoptosis. Two major pathways are involved, the death receptor (extrinsic) pathway and the mitochondrial (intrinsic) pathway.

Major features of the **death receptor pathway** are shown on the left-hand side of the figure. **External signals** initiating apoptosis include tumor necrosis factor- α (TNF- α) and Fas ligand. A number of death receptors have been identified. They are transmembrane proteins, some of which interact with **adapter proteins** (such as FADD [Fas-Associated protein with Death Domain]). These complexes in turn interact with **procaspase-8**, resulting in its conversion to **caspase-8** (an initiator). **Caspase-3** (an effector) is activated via a series of further reactions. It digests important structural proteins such as lamin (this is associated with nuclear condensation), various cytoskeletal proteins, and enzymes involved in DNA repair, causing cell death.

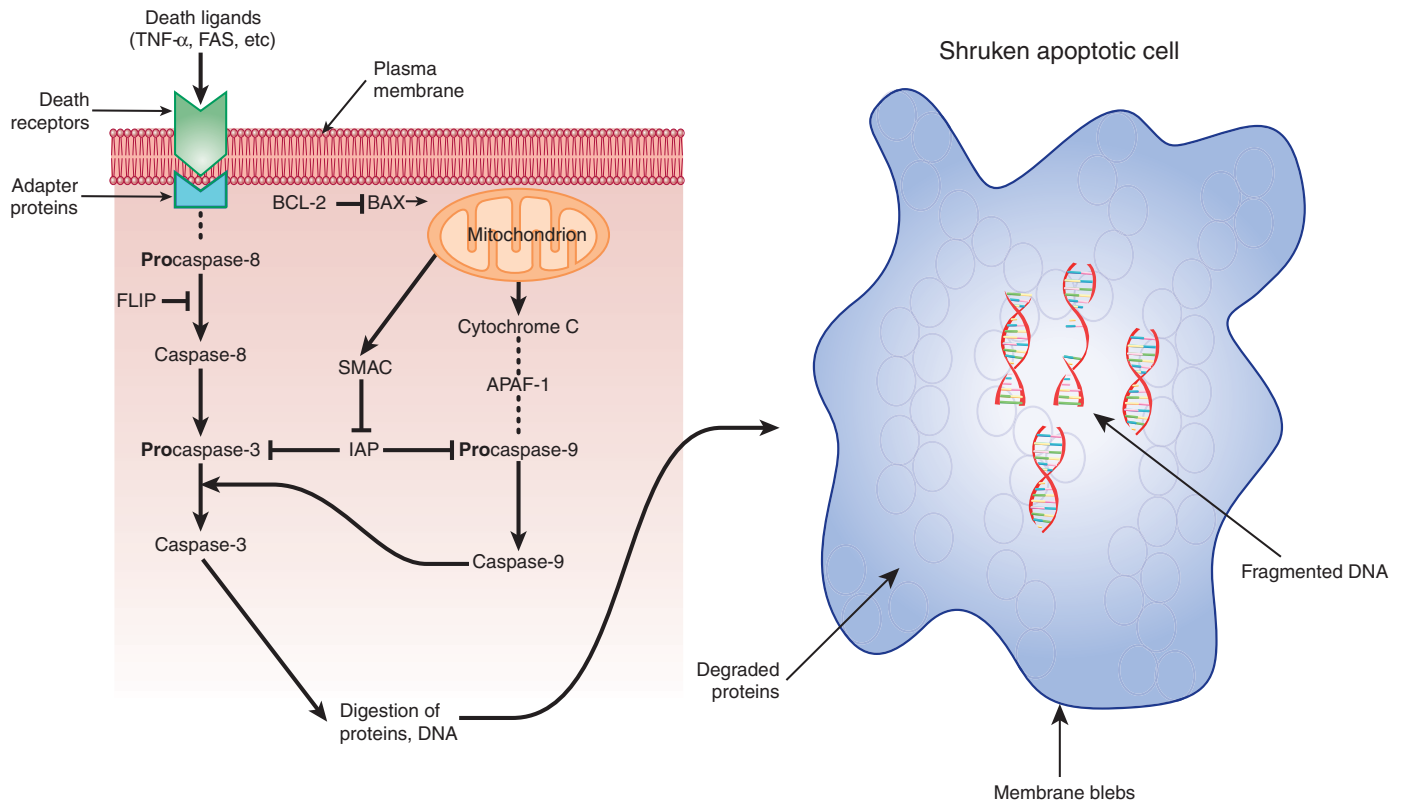

FIGURE 56-12 Scheme of apoptosis, much simplified. The major molecular events in the extrinsic pathway. Death signals include $\text{TNF-}\alpha$ and FAS (present on the surface of lymphocytes and some other cells). The signals (ligands) interact with specific death receptors (there are a number of them) Left. The activated receptor then interacts with an adapter protein (FADD is one of a number of them), and then forms a complex with pro-caspase 8. (The complex is indicated by the ... between the receptor and pro-caspase-8 in the figure). Through a series of further steps, active caspase-3 is formed, which is a major effector (executioner) of cell damage. Regulation of the extrinsic pathway can occur due to the inhibitory effect of FLIP on the conversion of pro-caspase-8 to caspase-8, and also the inhibitory effect of IAP on pro-caspase-3. The major cellular events in the intrinsic (mt) pathway. Various cell stresses affect the permeability of the mt outer membrane, resulting in efflux of cytochrome c into the cytoplasm. This forms a multiprotein complex with APAF-1 and pro-caspase-9, called an apoptosome. Through these interactions, pro-caspase-9 is converted to caspase-9. This, in turn, can act on pro-caspase-3 to convert it to its active form. Regulation of the intrinsic pathway can occur at the level of BAX, which facilitates increasing mitochondrial permeability permitting efflux of cytochrome c, and is thus pro-apoptotic. BCL-2-opposes this effect of BAX and is thus anti-apoptotic. IAP also inhibits pro-caspase-9, and this effect of IAP can be overcome by SMAC. (APAF-1, apoptotic protease activating factor-1; BAX, BCL-2-associated X protein; BCL-2, B-cell CLL/lymphoma 2 (CLL represents chronic lymphatic leukemia); FADD, FAS-associated via death domain; FAS, FAS antigen; FLICE, FADD-like ICE; FLIP, FLICE inhibitory protein; IAP, inhibitor of apoptosis proteins; ICE, interleukin-1- β convertase; SMAC, second mitochondria-derived activator of caspase.) --- signifies opposes the action of.

Regulation of this pathway occurs at several levels. **FLIP** inhibits the conversion of procaspase-8 to its active form. **Inhibitors of apoptosis (IAPs)** inhibit the conversion of procaspase-3 to its active form. These effects can be overcome by the protein **SMAC**, (second mitochondrial-derived activator of caspase), which is released from mitochondria.

The **mitochondrial pathway** can be initiated by exposure to reactive oxygen species, DNA damage and other stimuli. This results in pores forming in the outer mitochondrial membrane, through which **cytochrome c** escapes into the cytoplasm. In the cytoplasm, cytochrome c interacts with **APAF-1**, **procaspase-9**, and **ATP** to form a multi-protein complex known as an **apoptosome**. As a result of this interaction, **procaspase-9** is converted to its active form and, in turn, acts on **procaspase-3** to produce **caspase-3**.

Regarding **regulation**, activation of the **P53 gene** upregulates transcription of **BAX**. **BAX** is proapoptotic, in that it causes loss of mitochondrial membrane potential, helping initiate the mitochondrial apoptotic pathway. On the other hand, **BCL-2** inhibits this loss of membrane potential, and is thus antiapoptotic. IAPs inhibit conversion of procaspase 9 to caspase-9; **SMAC** can overcome this.

Note that the death pathway uses **caspase-8** as an initiator, whereas the mitochondrial pathway uses **caspase-9**. These two pathways can interact. In addition, there are also other pathways of apoptosis not discussed here.

Cancer Cells Evade Apoptosis

Cancer cells have developed mechanisms to evade apoptosis, and thus of continuing to grow and divide. In general,

these mechanisms involve mutations that cause loss of function of proteins that are proapoptotic, or from overexpression of antiapoptotic genes. One such example concerns loss of function of the *P53* gene, perhaps the most commonly mutated gene in cancers. Resultant loss of upregulation of proapoptotic *BAX* (see above) shifts the balance in favor of antiapoptotic proteins. Overexpression of many antiapoptotic genes is a frequent finding in cancers. The resulting evasion of apoptosis favors the continuing growth of cancers. Attempts are being made to develop drugs or other compounds that will specifically turn on apoptosis in cancer cells, terminating their lifespans.

As indicated above, apoptosis is a complex, highly regulated pathway with numerous participants, many of which are not mentioned here in this abbreviated account. Apoptosis is also involved in various developmental and physiological processes. It may seem paradoxical, but regulated cell death is as important in maintaining health, as is formation of new cells. In addition to cancer, apoptosis is implicated in other diseases, including certain autoimmune and chronic neurological disorders, such as Alzheimer disease and Parkinson disease, where **excessive cell death** (rather than excessive growth) is a feature.

Table 56–11 summarizes some of the principal features of apoptosis.

Proinflammatory & Tumor-Promoting Effects of Necrosis

Unlike apoptosis, necrosis of tissue results in release of intracellular contents into its surrounding microenvironment. These include proinflammatory mediators, which result in the infiltration of tissue by immune inflammatory cells. It has been

shown that such cells can have active tumor-promoting effects. Immune inflammatory cells have been reported to promote angiogenesis, cell proliferation and invasiveness. Thus, necrosis, which appears to counter the proliferative tendency of cancerous cells, may paradoxically benefit tumorigenesis. Thus, developing tumors appear to gain, by tolerance of some degree of cell necrosis, as this results in recruitment of inflammatory cells that supply the tumor cells with growth-promoting factors.

EPIGENETIC MECHANISMS ARE INVOLVED IN CANCER

There is growing evidence that epigenetic mechanisms (see Chapter 36) are involved in the causation of cancer. Such mechanisms produce nonmutational changes that affect regulation of gene expression. Methylation of specific cytosine bases in genes is implicated in turning off the activities of certain genes. Changes from normal in methylation/demethylation of cytosine residues in specific genes have been detected in cancer cells. Post translational modifications of histones, such as acetylation, methylation, phosphorylation, and ubiquitylation also affect gene expression. Changes in acetylation of histones H3 and H4 that affect gene transcription, have been found in cancer cells. Mutations affecting the structures of protein complexes (eg, the SWI/SNF complexes) involved in chromatin remodeling can also affect gene transcription. Indeed, several of the components of the Swi/Snf complexes may act as tumor suppressor genes. Some of these points about epigenetics are summarized in **Figure 56–13**.

A matter of particular interest regarding epigenetic changes is that many of these PTMs and DNA modifications are potentially **reversible**. In this regard, **5-azadeoxycytidine** and **decitabine** are inhibitors of **DNA methyltransferases (DNMTs)**, while **valproic acid** and **vorinostat** act to inhibit **histone deacetylases (HDACs)**. Both of these agents have been

TABLE 56–11 Summary of Some Important Features of Apoptosis

• It involves a genetically programmed series of events and differs from necrosis.
• The entire series of reactions is a cascade, similar to blood coagulation.
• It is characterized by cell shrinking, membrane blebbing, absence of inflammation, and a distinct pattern (laddering) of degradation of DNA.
• Many caspases (proteinases) are involved; some are initiators and others effectors (executioners).
• There are both extrinsic and intrinsic mitochondria pathways.
• FAS and other receptors are involved in the death receptor (external) pathway of apoptosis.
• Cellular stress and other factors activate the mt pathway; release of cytochrome c into the cytoplasm is an important event in this pathway.
• Apoptosis is regulated by a balance between inhibitors (antiapoptotic) and activators (proapoptotic).
• Cancer cells have acquired mutations that enable them to evade apoptosis, thus promoting cancer cell proliferation, albeit indirectly.

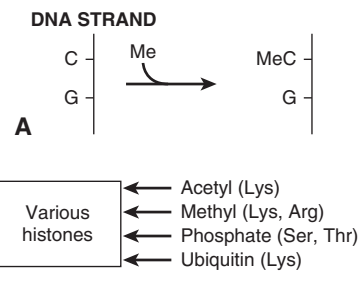

FIGURE 56–13 Some factors involved in epigenetics.

(A) Methylation of cytosine to form 5-methylcytosine. The cytosine is usually located next to a guanine residue, forming a CpG island. Methylation of cytosine by a methyltransferase is associated with silencing of the activities of certain genes. **(B)** Posttranslational modifications of various histones. Specific residues in specific histones are modified by various enzymes, changing the conformations and activities of the modified histones. For example, acetylation of N-terminal lysines in certain histones is associated with opening up of chromatin and with increased transcription of certain genes. See also chromatin modification and remodeling as detailed in Figures 36-10, 38-8 and 38-9.

used to treat certain types of leukemias and lymphomas and are thought to work by derepressing the transcription of certain critical growth regulatory genes such as tumor suppressors.

The increasing use of screening techniques for studying epigenetic changes (eg, analysis of the methylome [the sum total of methylation modifications genome-wide]) in more types of cancers is likely to add considerably to knowledge in this area.

THERE IS MUCH INTEREST IN THE ROLE OF STEM CELLS IN CANCER

Stem cells were discussed briefly in Chapters 39 and 52. Many scientists are currently investigating the role of stem cells in cancer. Cancer stem cells are believed to harbor mutations that, either by themselves or in collaboration with further mutations, make these cells cancerous. Stem cells can be detected by the use of specific surface markers, or other techniques. It appears that surrounding tissues (eg, components of the extracellular matrix) can significantly influence the behavior of these cells. An important concept driving some of the research in this area is the belief that one of the reasons that cancer chemotherapy is often not successful is that a **pool of cancer stem cells exists** that is not susceptible to conventional chemotherapy. Reasons for this include the facts that many stem cells are relatively dormant, have active DNA repair systems (see Figure 35–23), express drug transporters that can expel anticancer drugs, and are often resistant to apoptosis.

Evidence is accumulating that cancer stem cells do indeed play key roles in many types of neoplasia. If so, development of therapies with high specificity for killing these stem cells will prove of extreme value.

TUMORS OFTEN STIMULATE ANGIOGENESIS

Tumor cells need an adequate blood supply to provide nutrients for their survival. Both tumor cells and cells in tissues surrounding tumors have been found to **secrete angiogenic factors** that stimulate the growth of new blood vessels. There has been much interest in tumor angiogenesis, partly because if tumor angiogenesis could be specifically inhibited, this could provide a selective method of killing tumor cells.

The growth of blood vessels supplying tumor cells can be stimulated by **hypoxia** and other factors. Hypoxia causes elevated levels of **hypoxia-inducible factor-1 (HIF-1)**, which in turn increases levels of **vascular endothelial growth factor (VEGF)**, a major stimulant of angiogenesis. Some five types of VEGF have been identified (VEGF-A to VEGF-E), with most interest focusing on VEGF-A. VEGF proteins interact with specific tyrosine kinase receptors on endothelial and lymphatic cells. These receptors, via signaling pathways, cause upregulation of the NF- κ B pathway (see Chapter 50), resulting in proliferation of endothelial cells and formation of new blood vessels. Blood vessels supplying tumors are not normal; their structure

is often disorganized, they display lower integrity and consequently are often leakier than normal blood vessels. Molecules other than VEGFs, such as angiopoietin, β -fibroblast growth factor (β -FGF), TGF- β , and placental growth factor, also stimulate angiogenesis. Certain other molecules also inhibit blood vessel growth (eg, angiogenin and endostatin).

Monoclonal antibodies (mAbs) to VEGF-A have been developed (eg, bevacizumab or Avastatin) and have been used in the treatment of certain types of cancer (eg, colon and breast). These mAbs bind to VEGF and block it from acting, presumably by blocking VEGF from interacting with the VEGF receptor. These therapeutic mAbs were found to increase overall patient survival, but most patients eventually relapsed. Like with many antineoplastic therapies, it is now believed these mAbs are best used in combination with other anticancer therapies. Monoclonal antibodies to other growth factors that stimulate angiogenesis are also being developed and are in clinical trials, as are small molecule inhibitors of angiogenesis. Inhibitors of angiogenesis are useful in other conditions, such as “wet,” or age-related, macular degeneration and diabetic retinopathy, in which proliferation of blood vessels is a feature.

METASTASIS IS THE MOST SERIOUS ASPECT OF CANCER

It has been estimated that about **85% of the mortality** associated with cancer results from metastasis. Spread of cancer is usually via lymphatics or blood vessels. Metastasis is a complex process, and its molecular bases are yet to be fully elucidated.

Figure 56–14 is a simplified scheme of metastasis. The earliest event is **detachment** of tumor cells from the primary tumor. The cells can then gain access to the circulation (or lymphatics), a process termed **intravasation**. Once in the circulation, they tend to **arrest** in the nearest small capillary bed. In that site, they **extravasate** and **migrate** through the neighboring ECM, before finding a site to settle. Thereafter, if they survive host defense mechanisms, they grow at variable rates. To ensure growth, metastatic cells need an adequate blood supply, as discussed above.

Many studies have shown that cancer cells have an abnormal complement of proteins on their surfaces. These changes may permit decreased cell adhesion and allow individual cancer cells to detach from the parent cancer. Molecules on cell surfaces involved in cell adhesion are called **cell adhesion molecules**, or **CAMs (Table 56–12)**. Decreases in the amounts of **E-cadherin**, a molecule of major importance in the adhesion of many normal cells, may help to account for the decreased adhesiveness of many cancer cells. Many studies have shown changes in the oligosaccharide chains of cell surface glycoproteins, due to altered activities of various glycosyltransferases (see Chapter 47). One important change is an increase of the activity of GlcNAc transferase V. This enzyme catalyzes transfer of GlcNAc to a growing oligosaccharide chain, forming a β 1-6 linkage and allowing further growth of the chain. It has

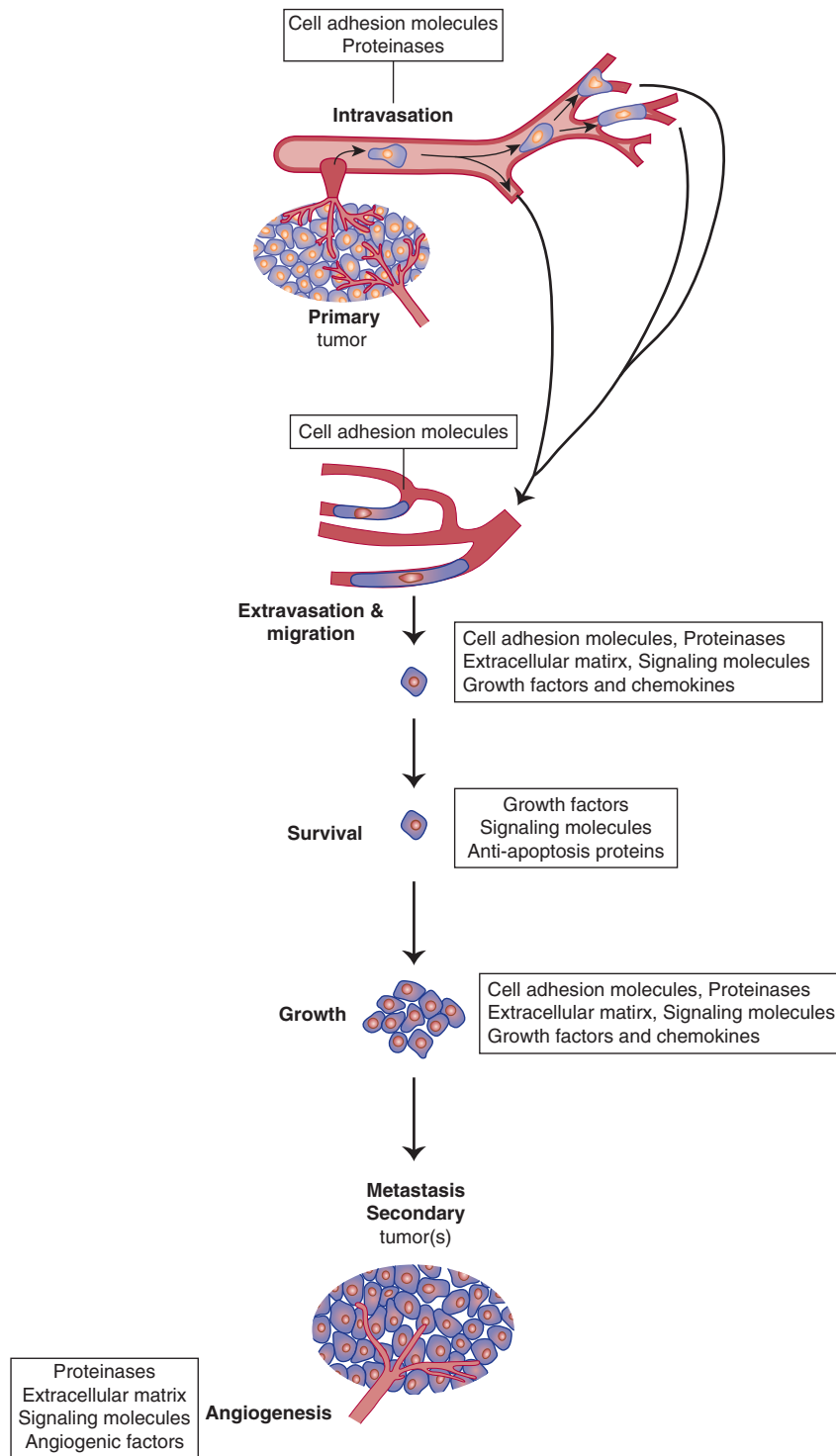

FIGURE 56-14 Simplified scheme of metastasis. Schematic representation of the sequence of steps in metastasis, indicating some of the factors believed to be involved. (From Tannock IF, et al: *The Basic Science of Oncology*. 4th ed. McGraw-Hill, 2005.)

been proposed that such elongated chains participate in an altered glycan lattice at the cell surface. This may cause structural reorganization of receptors and other molecules, perhaps predisposing to the spread of cancer cells.

An important property of many cancer cells is that they can release various **proteinases** into the ECM. Of the four

major classes of proteinases (serine, cysteine, aspartate and metallo-), in cancer, particular interest has focused on the **matrix metalloproteinases (MPs)**, which constitute a very large family of metal-dependent (usually zinc) enzymes. A number of studies have shown increased activity of MPs such as MP-2 and MP-9 (also known as gelatinases) in tumors.

TABLE 56–12 Some Important Cell Adhesion Molecules (CAMs)

• Cadherins
• Immunoglobulin (Ig) superfamily (Ig CAMs; cell adhesion molecules)
• Integrins
• Selectins

Note: CAMs may be homophilic or heterophilic. Homophilic CAMs interact with identical molecules on neighboring cells, whereas heterophilic CAMs interact with different molecules. Cadherins are homophilic, selectins and integrins are heterophilic, and Ig CAMs may be either. Integrins are discussed briefly in Chapter 52, and selectins in Chapter 46.

These enzymes are capable of degrading proteins in the basement membrane and in the ECM, such as collagen and others, facilitating the spread of tumor cells. Inhibitors of these enzymes have been developed, but so far these have not exhibited clinical success.

A factor that allows increased movement of cancer cells is **epithelial-to-mesenchymal transition**, or **EMT**. This is a change of cell morphology and function from epithelial to mesenchymal type, perhaps induced by growth factors. The mesenchymal type has more actin filaments, permitting increased movement, an essential property of cells that metastasize.

The **extracellular matrix** (ECM) plays an important role in metastasis. There is evidence of communication by signaling mechanisms between cancer cells and cells of the ECM. The types of cells in the ECM can also affect metastasis. As mentioned above, proteinases that degrade proteins in the ECM can facilitate spread of cancer cells. In addition, the ECM contains various growth factors that can influence tumor behavior.

On their travels, tumor cells are exposed to various cells of the immune system (such as T cells, NK cells, and macrophages), and must be able to survive exposure to them. Some of these surveillance cells secrete various **chemokines**, small proteins that can attract various cells such as leukocytes, sometimes causing an inflammatory response to tumor cells.

It has been estimated that only about 1:10,000 cancer cells may have the genetic capacity to successfully colonize. Certain tumor cells show a predilection to metastasize to specific organs (eg, prostate cells to bone). It is likely that specific cell surface molecules are involved in this tropism.

Various studies have shown that certain genes enhance metastasis, whereas others act as metastasis suppressor genes. Determining exactly how these genes work is the subject of intense investigation. **Table 56–13** summarizes some important points regarding metastasis.

CANCER CELLS EXHIBIT ALTERED METABOLIC PROGRAMMING

Many aspects of the metabolism of cancer cells (eg, of carbohydrates, lipids, amino acids, and nucleic acids) are being studied intensively due to the fact that changes in metabolism have now

TABLE 56–13 Important Features of Metastasis

• An epithelial-to-mesenchymal cell transition is often found in cancers, allowing increased movement of potentially metastatic cells.
• Metastasis is relatively inefficient (only about 1:10,000 tumor cells may have the genetic potential to colonize).
• Metastatic cells must evade various cells of the immune system to survive.
• Changes in cell surface molecules (eg, CAMs and others) are involved.
• Increased proteinase activity (eg, of MP-2 and MP-9) facilitates invasion.
• The existence of metastasis enhancer and suppressor genes has been shown.
• Some cancer cells metastasize preferentially to specific organs.
• Metastasis gene signatures may be detected by transcriptome/exome analysis; such transcriptome information can be of prognostic value, potentially allowing for personalized therapeutic treatment.

Abbreviations: CAM, cell adhesion molecule; MP, metalloproteinase.

been reproducibly observed in most cancer cells. This fact, coupled with recent large-scale exome DNA sequencing studies (ie, see above) that show that metabolic protein-encoding genes (and related genes) are commonly mutated in the 21 different common tumor types analyzed, has reinvigorated research in metabolism in general, and in cancer cell metabolism in particular.

Glucose and the amino acid glutamine are two of the most abundant metabolites in plasma, and together account for much of the carbon and nitrogen metabolism in human cells. In 1924, the biochemist Otto Warburg and his colleagues made the discovery that cancer cells take up large amounts of glucose and metabolize it to lactic acid, even in the presence of oxygen. This observation was termed the **Warburg effect**. Based on these data, Warburg made two hypotheses: first, that the increased ratio of glycolysis to aerobic respiration was likely due to defects in the mitochondrial respiratory chain; and second, that this enhanced glycolysis enabled cancer cells to preferentially proliferate in the reduced oxygen tension often seen in tumors. Furthermore, Warburg argued that the switch from aerobic to anaerobic glucose metabolism was a/the driver of tumorigenesis.

Recent work has shown though, that rather than overt defects in mitochondria the reprogrammed mitochondrial respiration typically observed in tumor cells is a direct effect of at least two kinds of influences. First, the self-sustaining proliferative growth factor signaling characteristic of cancer cells (ie, Figures 56–1 and 56–2); and second, genetic changes in specific metabolic enzyme-encoding genes and other genes. These genetic changes include preferential expression of certain mRNA splice variants (pyruvate kinase/*PKM*, phosphofructokinase/*PFKFB3*, glutaminase/*GLS*); amplification of particular enzyme-encoding genes (hexokinase II/*HXK2*, fatty acid synthase/*FASN*, phosphoglycerate dehydrogenase/*PHGDH*); altered catalytic efficiencies and specificities (isocitrate dehydrogenase 1 and 2/*IDH*, *IDH2*) and metabolic products (IDH enzymes normally produce α -ketoglutarate but the mutated IDH1 and/or IDH2 enzymes produce 2-hydroxyglutarate,

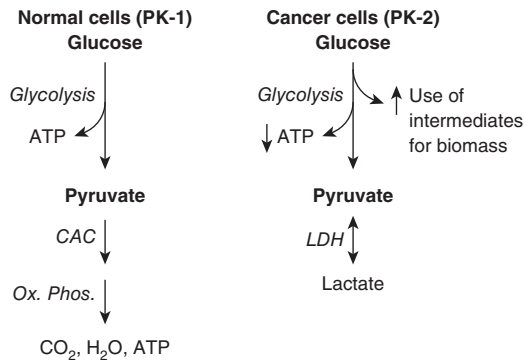

FIGURE 56-15 Pyruvate kinase isozymes and glycolysis in normal and in cancer cells. In normal cells, the major source of ATP is oxidative phosphorylation. Some ATP is obtained from glycolysis. The major pyruvate kinase (PK) isozyme in normal cells is PK-1. In cancer cells, aerobic glycolysis is prominent, lactic acid is produced via the action of lactate dehydrogenase (LDH) and production of ATP from oxidative phosphorylation is diminished (not shown in the figure). In cancer cells, PK-2 is the major PK isozyme. For complex reasons not as yet fully understood, this change of isozyme profile in cancer cells is associated with decreased net production of ATP from glycolysis, but increased use of metabolites to build up biomass. (CAC, citric acid cycle; OX PHOS, oxidative phosphorylation.)

or 2HG) and the effect that such “oncometabolites” (ie, 2HG) have on the epigenetic control of gene expression (DNA and histone protein methylation). Such **metabolic enzyme reprogramming** ultimately leads to less shuttling of glucose-derived chemical energy into the production of ATP (Figure 56-15), with a concomitant shunting of glucose chemical energy for building up the cellular biomass of proteins, lipids, nucleic acids, etc. These essential macromolecules are essential for cell proliferation (in this case, proliferation of cancer cells). Collectively these observations offer an explanation for the observed selective advantage conferred on tumor cells by having a high rate of glycolysis.

Given this data, a current promising approach is to analyze blood and urine by mass spectrometry looking for alterations in metabolite profile that can help detect cancer at an early stage.

Despite angiogenesis, many solid tumors have localized areas of **poor blood supply**, and thus show high rates of **anaerobic glycolysis**. This leads to excessive production of lactic acid and local **acidosis**. It has been postulated that local production of acid may allow tumor cells to invade more easily. The **low oxygen tension** in areas of tumors with poor blood supply stimulates the formation of **hypoxia-inducible factor-1 (HIF-1)**. This transcription factor, whose activity is turned on by low oxygen tension, up-regulates—among other actions—the activities of at least eight genes controlling synthesis of glycolytic enzymes.

The **pH** and **oxygen tension** in tumors are important factors affecting the actions of anticancer drugs and other treatments. For example, the anticancer efficacy of radiation treatment of cancers is significantly lower in hypoxic conditions. Chemicals have been developed to inhibit glycolysis in tumor cells, and perhaps selectively kill them (Table 56-14), and include **3-bromopyruvate** (an inhibitor of HK-2) and **2-deoxy-D-glucose** (an inhibitor of HK-1). Another

TABLE 56-14 Some Compounds That Inhibit Glycolysis and Have Been Found to Display Variable Anticancer Activity

Compound	Enzyme Inhibited
3-Bromopyruvate	Hexokinase II
2-Deoxy-d-glucose	Hexokinase I
Dichloroacetate	Pyruvate dehydrogenase kinase (PDH)
Iodoacetate	Glyceraldehyde-phosphate dehydrogenase

Note: The rationale for development of these agents is that glycolysis is usually much more active in tumor cells, so that inhibiting it may damage them more than normal cells. Inhibition of PDH kinase results in stimulation of PDH, diverting pyruvate away from glycolysis.

compound, **dichloroacetate (DCA)**, inhibits the activity of pyruvate dehydrogenase kinase, and thus stimulates the activity of pyruvate dehydrogenase (see Chapter 18), diverting substrate from glycolysis into the citric acid cycle. So far, none of these has attained much clinical use; perhaps second generation derivatives of these or other molecules that target metabolism will prove effective in humans as antitumor drugs.

TUMOR BIOMARKERS CAN BE MEASURED IN BLOOD & OTHER BODILY FLUID SAMPLES

Biochemical tests are often helpful in the management of patients with cancer (eg, some patients with advanced cancers may have elevated levels of plasma calcium, which can cause serious problems if not attended to). Many cancers are associated with the abnormal production of enzymes, proteins, and hormones that can be measured in plasma or serum. These molecules are known as **tumor biomarkers**. Some of them are listed in Table 56-15.

TABLE 56-15 Some Useful Tumor Biomarkers Measurable in Blood

Tumor Biomarker	Associated Cancer
Alpha-fetoprotein (AFP)	Hepatocellular carcinoma, germ cell tumor
Calcitonin (CT)	Thyroid (medullary carcinoma)
Carcinoembryonic antigen (CEA)	Colon, lung, breast, pancreas, ovary
Human chorionic gonadotropin (hCG)	Trophoblastic disease, germ cell tumor
Monoclonal immunoglobulin	Myeloma
Prostate-specific antigen (PSA)	Prostate

Note: Most of these tumor biomarkers are also elevated in the blood of patients with noncancerous diseases. For example, CEA is elevated in a variety of noncancerous gastrointestinal disorders, and PSA is elevated in prostatitis and benign prostatic hyperplasia. This is why interpretation of elevated results of tumor markers must be made with caution and why their main uses are to follow effectiveness of treatments and to detect recurrences. A number of other quite widely used tumor biomarkers are also available.

However, significant elevations of some of the biomarkers listed in Table 56–15 also occur in a variety of **noncancerous conditions**. For example, elevations of the level of **prostate-specific antigen (PSA)**, a glycoprotein synthesized by prostate cells, occur not only in patients with cancer of the prostate, but also in patients with prostatitis and **benign prostatic hyperplasia (BPH)**. Similarly, elevations of **carcinoembryonic antigen (CEA)** are found not only in patients with various types of cancer, but also in heavy smokers and people with ulcerative colitis and cirrhosis. The fact that elevations of tumor biomarkers are usually not specific for cancer has meant that measurements of most of them are not used primarily for diagnosis of cancer. Their main uses have been in following the effectiveness of treatments and in detecting early recurrence. The use of CEA in the management of a patient with colorectal cancer is discussed briefly in Chapter 57, Case 4. As with other laboratory tests (Chapter 56), the entire clinical picture must be considered when interpreting the results of measurements of tumor biomarkers.

It is hoped that ongoing **proteomic** analyses of body fluids and accessible cancer cells will provide new **tumor biomarkers** of increased sensitivity and specificity, and those capable of alerting one to the presence of cancers at an early stage of their development.

Transcriptome and whole genome sequencing analyses (see Chapter 39) of cancer cells have revealed a plethora of potentially very useful biomarkers of oncogenesis. These methods are also useful in more accurately subclassifying tumors (so called “personalized medicine”; see Chapter 39) in order to provide more accurate diagnoses and guide more efficacious modes of therapy. Such molecular diagnoses methods are becoming standard of care for a select subset of cancers. Finally, in this regard, a particularly promising new result was that DNA sequence analyses of DNA extracted from 5mL of blood obtained from cancer patients was able to accurately detect tumor DNA in from 50% to 75% of 640 patients with multiple types of tumors. This is a rapidly expanding area of laboratory analysis and oncology (see below).

KNOWLEDGE OF MECHANISMS INVOLVED IN CARCINOGENESIS HAS LED TO THE DEVELOPMENT OF NEW THERAPIES

One of the great hopes of cancer research is that revealing the fundamental mechanisms involved in cancer will lead to new and better therapy. This has already occurred to a certain extent, and it is hoped that ongoing developments will accelerate this process.

Classical chemotherapeutic drugs include alkylating agents, platinum complexes, antimetabolites, spindle poisons, and others. These will not be discussed here.

Among the classes of drugs developed more recently are inhibitors of signal transduction (including tyrosine kinase

TABLE 56–16 Some Anticancer Agents That Are Based on Recent Advances in Knowledge of Cancer Biology

Class	Example	Used to Treat
Inhibitors of signal transduction	Imatinib, an inhibitor of tyrosine kinase	CML
Monoclonal antibodies	Trastuzumab, a Mab to the HER2/Neu receptor	Late stage breast cancer
Antiangiogenesis agents	Bevacizumab, a Mab to VEGF A	Colon and breast cancers
Antihormonal agents	Tamoxifen, antagonist of the estrogen receptor	Breast cancer
Affect differentiation	All-trans retinoic acid, targets the retinoic leukemia acid receptor on promyelocytic leukemia cells causing them to differentiate	Promyelocytic leukemia
Affect epigenetic changes	5-Azadeoxycytidine, inhibits DNA methyltransferases SAHA inhibits histone deacetylases	Certain leukemias Cutaneous T-cell lymphoma

Abbreviations: CML, chronic myelocytic leukemia; Mab, monoclonal antibody; SAHA, suberoylanilide hydroxamic acid (Vorinostat); VEGF A, vascular endothelial growth factor A.

Note: In some cases, the above agents may have been replaced by other more effective agents. Also, certain of the above are used to treat conditions other than those listed.

inhibitors), monoclonal antibodies directed to various target molecules, inhibitors of hormone receptors, drugs that affect differentiation, anti-angiogenesis agents, and biologic response modifiers. Examples of each of these are listed in Table 56–16.

The finding of widespread defects in signaling mechanisms in cancer cells, and in particular the detection of mutations in **tyrosine kinases**, has led to the development of inhibitors of these enzymes. The most dramatic success has probably been the introduction of imatinib (marketed as Gleevec) for the treatment of **chronic myelocytic leukemia (CML)**. Imatinib is an orally administered drug that inhibits the tyrosine kinase formed due to the *ABL-BCR* chromosomal translocation involved in the genesis of CML. Imatinib, an ATP analog, competitively binds to the ATP-binding pocket of the kinase. This drug has produced complete remissions in many patients. It can be combined with other drugs. Other tyrosine kinase inhibitors have also been developed. Two of these are Erlotinib and Gefitinib, which inhibit the epidermal growth factor (EGF) receptor (EGFR). EGFR is overexpressed in certain lung (eg, non-small cell cancers) and breast cancers, resulting in aberrant (constitutive) signaling. It is important to appreciate that the design of such drugs requires **detailed structural knowledge** such as that provided by x-ray crystallography, NMR studies and model building of the molecules being targeted. Another class of drugs that have proven useful is **monoclonal antibodies** to various molecules exposed on the surfaces of neoplastic cells (see discussion above regarding

anti-VEGF mAb). A few of these mAbs that are clinically useful and therapeutic are listed in Table 56–16.

Other approaches to treating cancer that are being used, or being developed, but are not listed in Table 56–16, include various types of **gene therapy** (including siRNAs, Chapter 34), **immunotherapy** (see below), **oncolytic viruses** (viruses that preferentially invade tumor cells and kill them), **inhibitors of the progesterone receptor**, **aromatase inhibitors** (see Chapter 41) (for some breast and ovarian cancers), **telomerase inhibitors**, applications of **nanotechnology** (eg, nanoshells and other nanoparticles), **phototherapy** (see Chapter 31), and drugs that will **selectively target cancer stem cells**.

Like all drugs, it is important to appreciate that anticancer drugs have side effects, sometimes severe, and that resistance to many of them can develop after variable time periods. The biochemistry of how cancer cells develop resistance to drugs is an important area of research. Cancer cells use a number of strategies to develop drug resistance (see summary, **Table 56–17**). The overall thrust of drug development for cancer therapy is to use new information emerging from basic studies of cell, molecular, and cancer biology to develop safer and more effective agents. Intensive research over the past several decades has resulted in an increased understanding of genetic alterations that underlie the development of specific types of cancer. This knowledge has led to a shift from the use of broad-spectrum cytotoxic drugs to therapies that are

TABLE 56-17 Mechanisms by Which Cancer Cells Can Develop Drug Resistance

Mechanism of Drug Resistance	Example
Increased drug efflux from the cell	Overexpression of the transport proteins like multidrug resistance proteins (MDRs) (eg, P-glycoprotein or MDR1) causes efflux of major cancer chemotherapeutic drugs such as taxanes, topoisomerase inhibitors and antimetabolites.
Decreased drug activation	Decreased conversion of prodrugs (like 5-fluorouracil) to their active forms due to downregulation of enzymes that catalyze their activation.
Drug inactivation	Platinum drugs (cisplatin and carboplatin) are inactivated by conjugation with glutathione.
Increased drug target expression	Increased expression of thymidylate synthase, the target of antimetabolites like 5-fluorouracil.
Dysfunctional apoptosis	Overexpression of antiapoptotic proteins like BCL-2 family of proteins and decreased expression of proapoptotic proteins like BAX and BAK.
Activation of prosurvival signaling	Activation of epidermal growth factor receptor (EGFR)-mediated signaling in response to various chemotherapeutic drugs.
Modification of tumor microenvironment	Increased expression of integrins, proteins that attach cells to the extracellular matrix, which inhibits apoptosis and alters drug targets (environment-mediated drug resistance).

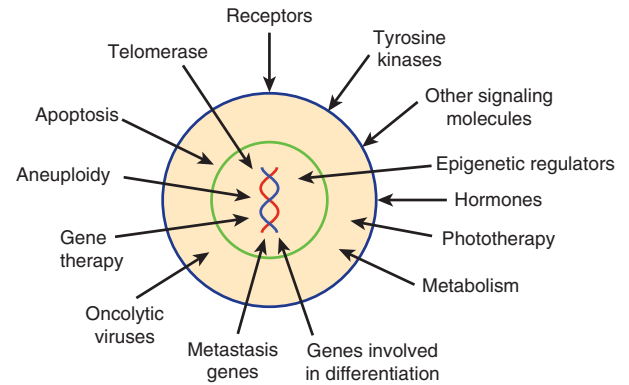

FIGURE 56-16 Examples of targets for anticancer drugs and some emerging therapies, both of which have developed from relatively recent research. Not shown in the figure are antiangiogenic agents, applications of nanotechnology, therapies directed against cancer stem cells and immunologic approaches. Most of the targets and therapies indicated are discussed briefly in the text.

specifically designed to target individual tumors. Currently, a major area of research is to identify specific **driver mutations**, mutations that play critical roles in development of tumors (ie, see discussion of colorectal cancer above). **Molecular profiling of cancer** in individual patients allows oncologists to choose the most appropriate drug or treatment modality that targets the molecular abnormality in each tumor. Such **personalized anticancer therapy** has been shown to significantly increase drug response and survival in various types of cancer. Understanding genetic differences in metabolism of anticancer drugs (see Chapter 53) may also help to personalize anticancer treatments.

Figure 56–16 summarizes some of the targets for drug therapy and some emerging therapies that have developed from relatively recent studies of basic aspects of cancer.

THERE ARE MANY IMMUNOLOGIC ASPECTS OF CANCER

Tumor immunology is a voluminous subject area, hence only a few comments will be made concerning this topic. It seems probable that the normal decline in immune responsiveness that accompanies **aging** plays a role in the increased incidence of cancer in older people. One long-standing hope has been that immunologic approaches to treat cancer (**immunotherapy**), because of their **specificity**, might be able to selectively kill cancer cells. There are many ongoing clinical trials investigating this possibility. These studies involve the use of antibodies, vaccines, and various types of T cells that have been manipulated in one way or another to increase their ability to kill neoplastic cells. One of the methods proven to be effective is the use of antibodies against certain T lymphocyte surface proteins. For example, antibodies developed against cytotoxic T-lymphocyte antigen 4 (anti-CTLA-4) or programmed death–1 (anti-PD1) have been shown to

“remove the brakes” on these cells, thus setting them free to attack cancer cells. Other strategies using modified T cells have proven to be effective as well. The major advantage of immunotherapy is that it has a broad-spectrum of action and can therefore be used against a wide variety of cancers. In addition, resistance is less likely to occur to this form of treatment. It is hoped that immunotherapy will be the fourth major weapon against cancer, after surgery, radiotherapy and chemotherapy, making it *Science* magazine’s “Breakthrough of the Year 2013.”

Chronic inflammation involves aspects of immune function. There is evidence that it can **predispose to cancer** (eg, the incidence of colorectal cancer is much higher than normal in individuals who have had long-standing ulcerative colitis). Some inflammatory cells produce relatively large amounts of **reactive oxygen species**, which can cause damage to DNA, and perhaps contribute to oncogenesis. It has also been reported that **low doses of aspirin** may lower the risk of development of colorectal cancer, perhaps via its anti-inflammatory action.

Cancer: Relationship to Inflammation & Obesity

The association between inflammation and cancer is now well established. Inflammation is a critical component of tumorigenesis. That said, the exact mechanisms linking inflammation and cancer are only poorly understood. Examples of possible molecules that are involved in induction of an inflammatory process include nuclear factor kappa B (NF- κ B) and signal transducer and activator of transcription 3 (STAT3). NF- κ B is a transcription factor that induces expression of proteins that are involved in proinflammatory, proliferative, and reparative processes. Activation of NF- κ B has been shown to occur in tumors in response to inflammatory stimuli or oncogenic mutations (Chapter 42). Signaling via STAT3 is activated by interleukin 6 (IL-6), a proinflammatory cytokine, which activates Janus kinase (JAK)-STAT signaling and its downstream effects events (see Chapter 42). Such events are thought to be responsible for driving many hallmark features of cancer. In addition, the “**inflammasome**,” a multiprotein complex that acts as a sensor of cellular damage, is another potential candidate that mediates inflammation. Activation of inflammasomes leads to secretion of proinflammatory cytokines such as IL-1 β and IL-18, both of which have been implicated in tumorigenesis. There is a large body of evidence to implicate other inflammatory mediators in the development of tumors.

Obesity is associated with low-grade inflammation. Visceral adipose tissue is considered an important source of proinflammatory cytokines and other factors implicated in the process. It is now known that the microenvironment that surrounds tumor cells influences tumorigenesis. Inflammatory cells in the microenvironment of the tumor are considered to play a crucial role in the process. Obesity has been shown to mediate and exacerbate dysfunctional changes in the

microenvironment; this has been shown to occur in both normal tissue and in tumors. Such changes include alterations in factors that may be endocrine, metabolic, or inflammatory in nature. By contrast, caloric restriction has been shown to inhibit tumorigenesis in experimental models. Many cellular pathways, such as those involving growth factor signaling, inflammation, cellular homeostasis, and the tumor microenvironment are affected by such caloric restriction. These observations suggest that such targets may be considered for prevention of cancer in humans.

SUMMARY

- Cancer is due to mutations in the genes that control cell multiplication, cell death (apoptosis) and cell-cell interactions (eg, cell adhesion). Other important aspects of cancer are defects in cell signaling pathways, stimulation of angiogenesis, aneuploidy, and changes in the cell microenvironment.
- The great majority of cancers are due to mutations affecting somatic cells. However, a number of hereditary cancers have been identified.
- Major classes of genes involved in cancer are oncogenes and tumor suppressor genes. Mutations affecting genes directing the synthesis and expression of microRNAs are also important.
- Epigenetic changes are increasingly being recognized in cancer (and in other diseases); one reason for interest in epigenetics is that the epigenetic “marks” responsible are likely reversible by drugs.
- Mechanisms of metastasis are being explored intensively; the discovery of metastasis enhancer and suppressor genes, among other findings, may lead to new therapies.
- Apoptosis, programmed cell death, plays important roles in oncogenesis. Cancer cells acquire mutations that permit them to evade apoptosis, thus prolonging and enabling their continued replication.
- Whole genome and exome sequencing of cancer cells is helping to reveal the important mutations present in many types of cancer and is yielding new information on the evolution of cancer cells.
- Cancer cells show various alterations of metabolism. One major finding that has attracted much attention is the high rate of aerobic glycolysis exhibited by many cells. Possible explanations for this phenomenon are described. Mitochondrial functions are altered in many cancer cells.
- Overall, the development of cancer is a multistep process involving genetic, epigenetic, and microenvironment changes that confer selective advantages on clones of cells, some of which eventually acquire the ability to metastasize successfully. Because of the diversity of mutations, it is possible that no two tumors have identical genomes.
- Tumor markers may help in the early diagnosis of cancer. They are of particular use in following the response of cancer to treatment and in detecting recurrences. Such markers can be small molecules, proteins or as shown very recently, circulating tumor-derived DNA.

- Advances in understanding the molecular biology of cancer cells have led to the introduction of a number of new therapies, with others in the pipeline.

REFERENCES

- Alexandrov LB, Nik-Zainal S, Wedge DC, et al: Signatures of mutational processes in human cancer. *Nature* 2013;500:415–421.
- Bettegowda C, Sausen M, Leary RJ: Detection of circulating tumor DNA in early- and late-stage human malignancies. *Sci Trans Med* 2014;6(224):224ra24.
- Dawson MA, Kouzarides T: Cancer epigenetics: from mechanism to therapy. *Cell* 2012;150:12–27.
- Elinav E, Nowarski R, Thaiss CA, et al: Inflammation-induced cancer: crosstalk between tumors, immune cells and microorganisms. *Nature Rev Cancer* 2013;13:759–771.
- Green DR: *Means to an End: Apoptosis and Other Cell Death Mechanisms*. Cold Spring Harbor Press, 2010.
- Hanahan D, Weinberg RA: Hallmarks of cancer: the next generation. *Cell* 2011;144:646–674.
- Holohan C, Van Schaeybroeck S, Longley DB, et al: Cancer drug resistance: an evolving paradigm. *Nat Rev Cancer* 2013;13:714–726.
- Lawrence MS, Stojanov P, Mermel CH, et al: Discovery and saturation analysis of cancer genes across 21 tumor types. *Nature* 2014;505:495–501.
- Ling H, Fabbri M, Calin GA: MicroRNAs and other non-coding RNAs as targets for anticancer drug development. *Nat Rev Drug Discov* 2013;12:847–865.
- Link A, Balaguer F, Goel A: Cancer chemoprevention by dietary polyphenols: promising role for epigenetics. *Biochem Pharmacol* 2010;80:1771–1792.
- Lodish H, Berk A, Kaiser CA, et al: *Molecular Cell Biology*. 7th ed. WH Freeman & Co, 2012. (Contains a comprehensive chapter on cancer.)
- Tafani M, Pucci B, Russo A, et al: Modulators of HIF1a and NFkB in cancer treatment: is it a rational approach for controlling malignant progression? *Frontiers Pharmacol* 2013;4:1–10.
- Vogelstein B, Papadopoulos N, Velculescu VE, et al: Cancer genome landscapes. *Science* 2013;339:1546–1558. (This is one of four reviews on cancer biology in this issue of *Science*.)
- Ward PS, Thompson CB: Metabolic reprogramming: a cancer hallmark even Warburg did not anticipate. *Cancer Cell* 2012;21:297–308.
- Weinberg R: *The Biology of Cancer*, 2nd ed. Garland Science, 2013.
- Yachida S, Jones S, Bozic I, et al: Distant metastasis occurs late during the genetic evolution of pancreatic cancer. *Nature* 2010 (Oct 28);467(7319):1114.
- Zhao J, Lawless MW: Stop feeding cancer: proinflammatory role of visceral adiposity in liver cancer. *Cytokine* 2013;64:626–637.

USEFUL WEB SITES

- American Cancer Society. <http://www.cancer.org>
- National Cancer Institute, U.S. National Institute of Health. <http://www.cancer.gov>
- The Cancer Genome Atlas. <http://cancergenome.nih.gov>

GLOSSARY

- Adenomatous polyp:** A benign tumor of epithelial origin that has the potential to become a carcinoma. Adenomas are often polypoid. A polyp is a growth that protrudes from a mucous membrane; most are benign, but some polyps can become malignant.
- Ames assay:** An assay system devised by Dr Bruce Ames that uses specially designed *Salmonella typhimurium* to detect mutagens. Most carcinogens are mutagens, but if mutagenicity of a chemical is detected, ideally new chemical compounds should be tested for carcinogenicity by animal testing.
- Aneuploidy:** Refers to any condition in which the chromosome number of a cell is not an exact multiple of the basic haploid number. Aneuploidy is found in many tumor cells and may play a fundamental role in the development of cancer.
- Angiogenesis:** The formation of new blood vessels. Angiogenesis is often active around tumor cells, ensuring that they obtain an adequate blood supply. A number of growth factors are secreted by tumor and surrounding cells (eg, vascular endothelial growth factor, or VEGF) and are involved in this process.
- Apoptosis:** Cell death due to activation of a genetic program that causes fragmentation of cellular DNA and other changes. Caspases play a central role in the process. Many positive and negative regulators affect it. The protein p53 induces apoptosis as a response to cell DNA damage. Most cancer cells exhibit abnormalities of apoptosis, due to various mutations that help to ensure their prolonged survival.
- Benign tumor:** A mass of abnormal proliferating cells whose growth is driven by mutations in at least one tumor suppressor or oncogene. These tumor cells are noninvasive and do not metastasize.
- Biologic response modifiers:** Molecules produced by the body or in the laboratory that when administered to patients alter the body's response to infection, inflammation and other processes. Examples include monoclonal antibodies, cytokines, interleukins, interferons, and growth factors.
- Bloom syndrome:** One of the CIN syndromes. Due to mutations in a DNA helicase; subjects are sensitive to DNA damage and may develop various tumors.
- Burkitt lymphoma:** This is a B cell lymphoma, endemic in parts of Africa, where it mainly affects the jaw and facial bones. It is also found elsewhere. A reciprocal translocation involving the *C-MYC* gene on chromosome 8 and the immunoglobulin heavy chain gene on chromosome 14 is characteristic.
- Cancer:** A malignant growth of cells.
- Cancer stem cell:** A cell within a tumor that has the capacity to self-renew and to give rise to the heterogeneous lineages of cancer cells found in the tumor.
- Carcinogen:** Any agent (eg, a chemical or radiation) capable of causing cells to become cancerous.
- Carcinoma:** A malignant growth of epithelial origin. A cancer of glandular origin or showing glandular features is usually designated as an adenocarcinoma.
- Caspases:** Proteolytic enzymes that play a central role in apoptosis, but are also involved in other processes. Some 15 are present in humans. Caspases hydrolyze peptide bonds just C-terminal to aspartate residues.
- Cell cycle:** The various events pertaining to cell division, that occurs as a cell goes from one mitosis to another.

- Centriole:** An array of microtubules that is paired and found in the center of a centrosome. (Also see **Centrosome**.)
- Centromere:** The constricted region of a mitotic chromosome where chromatids are joined together. It is in close proximity to the kinetochore. Abnormalities of centromeres may contribute to CI. (Also see **Kinetochore**.)
- Centrosome:** A centrally located organelle that is the primary microtubule-organizing center of a cell. It acts as the spindle pole during cell division.
- Chromatid:** A single chromosome.
- Chromatin remodeling:** This involves conformational changes of nucleosomes brought about by the actions of multiprotein complexes (such as the SW1/SNF complex). These changes alter gene transcription (turning it on or off, depending on specific conditions). The complexes contain domains homologous to ATP-dependent helicase; these are involved in the changes of conformation. Mutations affecting proteins of the complexes, such as may be found in cancer cells, can affect gene expression. (See also **Epigenetics**.)
- Chromosomal instability (CIN):** The rate of gain or loss of whole chromosomes or segments of them caused by abnormalities of chromosome segregation during mitosis. (See also **Genome instability** and **Microsatellite instability**.) There are a number of disorders that are named CIN syndromes because they are associated with chromosomal abnormalities. One such is Bloom syndrome, in which a high frequency of sister chromatid exchanges is observed. An increased incidence of various cancers is found in these conditions.
- Chromosomal passenger complex:** A complex of proteins that plays a key role in regulating mitosis. At the centromere, it directs alignment of the chromosome and participates in spindle assembly. Its proteins include aurora B kinase and survivin. Mutations affecting its proteins may contribute to CI and aneuploidy.
- Chromosomal translocation:** When part of one chromosome becomes fused to another, often causing activation of a gene at the site. The Philadelphia chromosome (see below) is one of many examples of a chromosomal translocation involved in the causation of cancer.
- Clone:** All the cells of a clone are derived from one parent cell.
- Copy number variations (CNVs):** Variations (because of duplications or deletions) among individuals as to the number of copies they have of particular genes. CNVs are being increasingly recognized for various genes, and some may be associated with various diseases, including certain types of cancer.
- Driver mutation:** A mutation in a gene that either helps cause cancer or accelerates it. Mutations found in tumors that do not cause cancer or its progression are called passenger mutations.
- Epigenetic:** Refers to changes of gene expression without change of the sequence of bases in DNA. Factors causing epigenetic changes include methylation of bases in DNA, posttranslational modifications of histones and chromatin remodeling.
- FAS receptor:** A receptor that initiates apoptosis when it binds its ligand, FAS. FAS is a protein present on the surface of activated natural killer cells, cytotoxic T lymphocytes and other sources.
- Gatekeeper:** A mutated version of a gene that initiates the cascade of events that cause oncogenesis (eg, *RB*).
- Genome instability:** This refers to a number of alterations of the genome, of which the two principal ones are CIN and microsatellite instability. In general, it reflects the fact that the genomes of cancer cells are more susceptible to mutations than are normal cells, in part due to impairment of DNA repair systems.
- Growth factors:** A variety of polypeptides secreted by many normal and tumor cells. These molecules act via autocrine (affects the cells that produce the growth factor), paracrine (affects neighboring cells) or endocrine (travels in the blood to affect distant cells) modes. They stimulate proliferation of target cells via interactions with specific receptors. They also have many other biologic properties.
- Hypoxia-inducible factors (HIFs):** A family of transcription factors (at least three) important in directing cellular responses to varying levels of oxygen. Each factor is made up of a different oxygen-regulated α -subunit and a common constitutive β -subunit. At physiological levels of oxygen, the α -subunit undergoes rapid degradation, initiated by prolyl hydroxylases. HIFs have various functions; eg, HIF-1 up-regulates various genes encoding enzymes of glycolysis, and also the expression of vascular endothelial growth factor (VEGF).
- Kinetochore:** A structure that forms on each mitotic chromosome adjacent to the centromere. Mutations affecting the structures of its component proteins could contribute to causing CI. (See also **Centromere**.)
- Leukemias:** A variety of malignant diseases in which various white cells (eg, myeloblasts, lymphoblasts, etc) proliferate in an unrestrained manner. Leukemias may be acute or chronic.
- Loss of heterozygosity (LOH):** This occurs when there is loss of the normal allele (often encoding a tumor suppressor gene) from a pair of heterozygous chromosomes, allowing the results of the defective allele to be manifest clinically.
- Lymphoma:** A group of neoplasms arising in the reticuloendothelial and lymphatic systems. Major members of the group are Hodgkin and non-Hodgkin lymphomas.
- Malignant cells:** They are cancer cells—cells with the ability to grow in an unrestrained manner, to invade, and to spread (metastasize) to other parts of the body.
- Metastasis:** The ability of cancer cells to spread to distant parts of the body and grow there.
- Microsatellite instability:** Expansion or contraction of short tandem repeats (microsatellites) due to replication slippage, abnormalities of mismatch repair or of homologous recombination. For **Microsatellites**, see Chapter 35.
- Nanotechnology:** The development and application of devices that are only a few nanometers in size. (10^{-9} m equals = 1 nm). Some are being applied to cancer therapy. For example, **nanoshells** (very small spherical particles with a silica core and a gold covering) tuned to near-infrared light have been administered to mice with tumors, in which the nanoshells accumulate. The tumors were subsequently subjected to near infrared laser light. This heated the tumors selectively, killed them, and there was no sign of recurrence on follow-up. (Morton JG, et al: Nanoshells for photothermal cancer therapy. *Methods Mol Biol* 2010;624:101. June 25, 2010.)
- Necrosis:** Cell death induced by chemicals or tissue injury. Various hydrolytic enzymes are released and digest cellular molecules. It is not a genetically programmed process, as is apoptosis. Affected cells usually burst and release their contents, causing local inflammation.
- Neoplasm:** Any new growth of tissue, benign or malignant.
- Oncogene:** A mutated proto-oncogene whose protein product is involved in the transformation of a normal cell to a cancer cell.

Oncology: The area of medical science that concerns itself with all aspects of cancer (causes, diagnosis, treatment, etc).

Philadelphia chromosome: A chromosome formed by a reciprocal translocation between chromosomes 9 and 22. It is the cause of chronic myeloid leukemia (CML). To form the abnormal chromosome, part of the *BCR* (breakpoint cluster region) gene of chromosome 22 fuses with part of the *ABL* gene (encodes a tyrosine kinase) of chromosome 9, directing the synthesis of a chimeric protein that has unregulated tyrosine kinase activity and drives cell proliferation. The activity of this kinase is inhibited by the drug Imatinib (Gleevec), which has been successfully used to treat CML. (See also **Chromosomal translocation**.)

Procarcinogen: A chemical that becomes a carcinogen when altered by metabolism.

Proto-oncogene: A normal cellular gene, which when mutated can give rise to a product that stimulates the growth of cells, contributing to the development of cancer.

Replication slippage: A process in which, because of misalignment of DNA strands where repeat sequences occur, DNA polymerase pauses and dissociates, resulting in deletions or insertions of repeat sequences.

Retinoblastoma: A rare tumor of the retina. Mutation of the *RB* tumor suppressor gene plays a key role in its development. Patients with hereditary retinoblastomas have inherited one mutated copy of the *RB* gene, and need only one further mutation to develop the tumor. Patients with sporadic retinoblastomas are born with two normal copies, and require two mutations to inactivate the gene.

Rous sarcoma virus (RSV): An RNA tumor virus that causes sarcomas in chickens. It was discovered in 1911 by Peyton Rous.

It is a retrovirus, using reverse transcriptase in its replication; the DNA copy of its genome subsequently integrates into the host cell genome. It has been widely used in studies of cancer, and its use has led to many important findings.

Sarcoma: A malignant tumor of mesenchymal origin (eg, from cells of the extracellular matrix or other sources).

Telomeres: Structures at the ends of chromosome that contain multiple repeats of specific hexanucleotide DNA sequences. The telomeres of normal cells shorten on repeated cell division, which may result in cell death. The enzyme telomerase replicates telomeres and is often expressed in cancer cells, helping them to evade cell death. Telomerase is usually not detected in normal somatic cells.

Translocation: The displacement of one part of a chromosome to a different chromosome or to a different part of the same chromosome. Classic examples are the translocation found in Burkitt lymphoma (see above) and the translocation between chromosomes 9 and 22, which causes the appearance of the Philadelphia chromosome found in chronic myelogenous leukemia. Translocations have been found in many cancer cells.

Transformation: The process by which normal cells in tissue culture become changed to abnormal cells (eg, by oncogenic viruses or chemicals), some of which may be malignant.

Tumor: Any new growth of tissue, but usually refers to a benign or malignant neoplasm.

Tumor suppressor gene: A gene whose protein product normally restrains cell growth, but when its activity is lost or reduced by mutation contributes to the development of a cancer cell.

Biochemical Case Histories

David A. Bender, PhD

OBJECTIVES

After studying this book, you should be able to:

- Use your knowledge to explain the underlying biochemical defects in diseases.

INTRODUCTION

In this final chapter, nine case histories are presented as open-ended problems for you to solve, based on what you have learnt from studying this book. No solutions are provided, and there is no discussion of the cases; all that you need to know in order to explain the problems is available elsewhere in this book.

In many cases the patient's clinical chemistry results are presented together with reference ranges. These may differ from problem to problem, and from the reference ranges in Table 48–3, because, as discussed in Chapter 48, reference ranges from different laboratories differ in many cases.

CASE 1

The patient is a 5-year-old boy, who was born in 1967, at term, after an uneventful pregnancy. He was a sickly infant, and did not grow well. On a number of occasions his mother noted that he appeared drowsy, or even comatose, and said that there was a “chemical, alcohol-like” smell on his breath, and in his urine. The GP suspected diabetes mellitus, and sent him to the Middlesex Hospital in London for a glucose tolerance test. The results are shown in **Figure 57–1**.

Blood samples were also taken for measurement of insulin at zero time and 1 hour after the glucose load. At this time a new method of measuring insulin was being developed, radioimmunoassay (see Chapter 48), and therefore both this and the conventional biological assay were used. The biological method of measuring insulin is by its ability to stimulate the uptake and metabolism of glucose in rat muscle *in vitro*; this can be performed relatively simply by measuring the

radioactivity in $^{14}\text{CO}_2$ after incubating duplicate samples of the muscle with $[^{14}\text{C}]$ glucose, with and without the sample containing insulin. The results are shown in **Table 57–1**.

As a part of their studies of the new radioimmunoassay for insulin, the team at the Middlesex Hospital performed gel exclusion chromatography of a pooled sample of normal serum, and determined insulin in the fractions eluted from the columns both by radioimmunoassay (graph A in **Figure 57–2**) and by stimulation of glucose oxidation (graph B). Three molecular mass markers were used; they eluted as follows: M_r 9000 in fraction 10, M_r 6000 in fraction 23, and M_r 4500 in fraction 27.

The investigators also measured insulin in the fractions eluted from the chromatography column after treatment of each fraction with trypsin. The results are shown in graph C.

After seeing the results of these studies, they subjected the same-pooled serum sample to brief treatment with trypsin, and performed gel exclusion chromatography on the product. Again they measured insulin by radioimmunoassay (graph D) and biological assay (graph E).

Since these studies in the 1960s, the gene for human insulin has been cloned. Although insulin consists of two peptide chains, 21 and 30 amino acids long, respectively, these are coded for by a single gene, which has a total of 330 base pairs between the initiator and stop codons. As you would expect for a secreted protein, there is a signal sequence coding for 24 amino acids at the 5' end of the gene.

What does this information suggest about the processes that occur in the synthesis of insulin?

What is likely to be the underlying biochemical basis of the patient's problem?

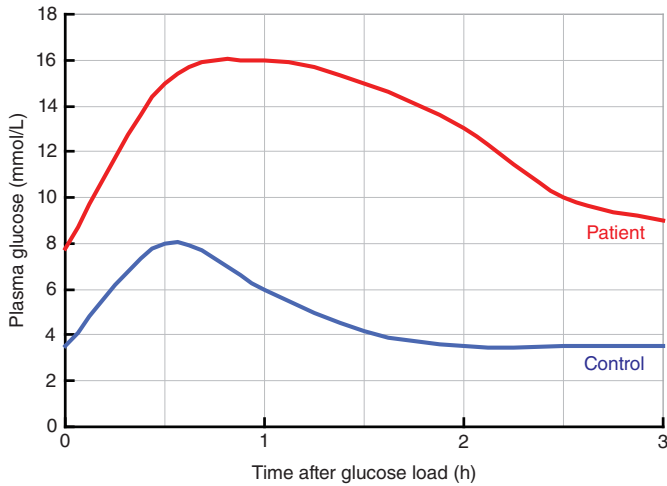

FIGURE 57-1 Plasma glucose in the patient and a control subject after a test dose of glucose.

CASE 2

The patient is a 50-year-old man, 174 cm tall and weighing 105 kg. He is an engineer, and works on secondment in one of the strict Islamic states in the Gulf, where alcohol is prohibited. At the beginning of August he returned home for his annual leave. According to his family, he behaved as he usually did when on leave, consuming a great deal of alcohol and refusing meals. He was known to be drinking 2 L of whiskey, two or three bottles of wine, and a dozen or more cans of beer each day; his only solid food consisted of sweets and biscuits.

On September 1st he was admitted to the emergency department, semiconscious, and with a rapid respiration rate (40/minute). His blood pressure was 90/60 and his pulse rate was 136/minute. His temperature was normal (37.1°C). Emergency blood gas analysis revealed severe acidosis: pH 7.02 and base excess -23; pO₂ 91 mm Hg and pCO₂ 10 mm Hg. He was transferred to intensive care and given intravenous bicarbonate.

His pulse rate remained high, and his blood pressure low, so emergency cardiac catheterization was performed; this revealed a cardiac output of 23 L/min (normal 4-6). A chest x-ray shows significant cardiac enlargement.

Table 57-2 shows the clinical chemistry results from a plasma sample taken shortly after he was admitted.

- What is the likely biochemical basis of the patient’s problem, which led to his emergency hospitalization?
- What additional test(s) might you request to confirm your assumption?
- What emergency treatment would you suggest?

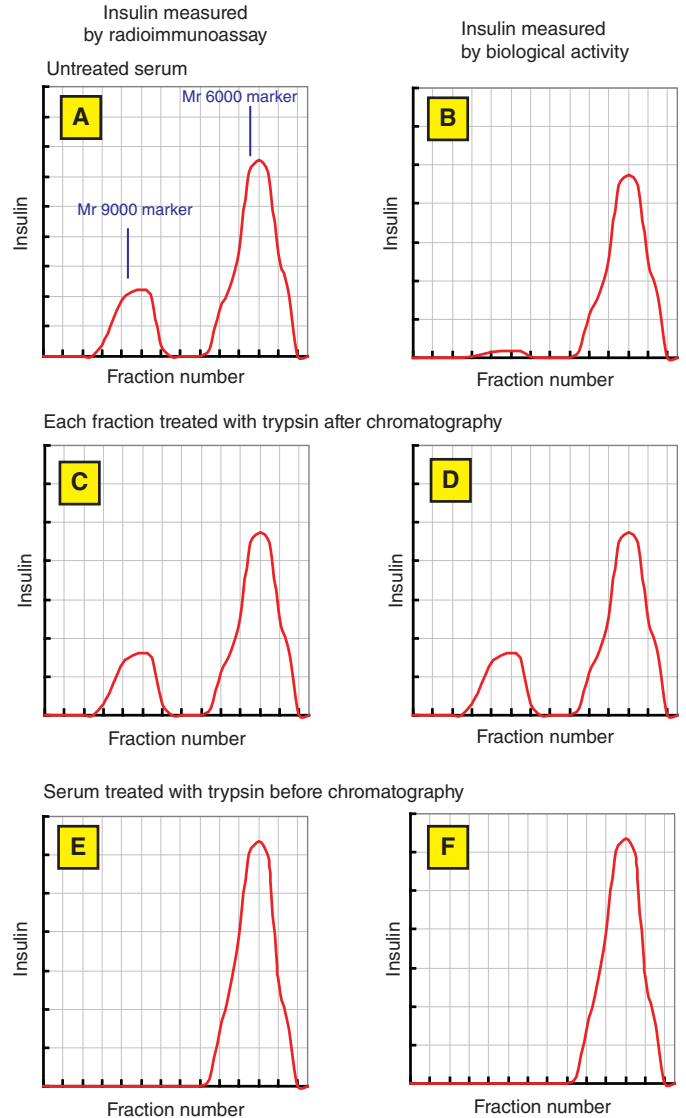

FIGURE 57-2 Insulin measured by radio-immunoassay and biological assay before and after treatment of plasma samples with trypsin.

CASE 3

The patient is an African American recruit to the army. He was given the antimalarial drug primaquine, and suffered a delayed reaction with kidney pain, dark urine, and low red blood cell counts that led to anemia and weakness. Centrifugation of a blood sample showed a low hematocrit, and the plasma was red colored.

Similar acute hemolytic attacks have been observed, predominantly in men of Afro-Caribbean origin, in response to

TABLE 57-1 Serum Insulin (mU/L) Measured by Biological Assay and Radioimmunoassay

	Baseline (Fasting) Blood Sample		1 Hour After Glucose Load	
	Patient (Case 1)	Control Subjects	Patient (Case 1)	Control Subjects
Biological assay	0.8	6 ± 2	5	40 ± 11
Radioimmunoassay	10	6 ± 2	50	40 ± 11

TABLE 57-2 Clinical Chemistry Results for the Patient in Case 2 on Admission. All Values Are mmol/L

	Patient in Case 2	Reference Range
Glucose	10.6	3.5-5
Sodium	142	131-151
Potassium	3.9	3.4-5.2
Chloride	91	100-110
Bicarbonate	5	21-29
Lactate	18.9	0.9-2.7
Pyruvate	2.5	0.1-0.2

primaquine and a variety of other drugs, including dapson, the antipyretic acetylphenylhydrazine, the antibacterial bactrim/septin, sulfonamides, and sulfones, whose only common feature is that they all undergo cyclic nonenzymic reactions in the presence of oxygen to produce hydrogen peroxide and a variety of oxygen radicals that can cause oxidative damage to membrane lipids, leading to hemolysis. Moderately severe infection can also precipitate a hemolytic crisis in susceptible people.

One way of screening for sensitivity to primaquine is based on the observation that the glutathione concentration of erythrocytes from sensitive subjects is somewhat lower than that of control subjects, and falls considerably on incubation with acetylphenylhydrazine.

Glutathione (GSH) is a tripeptide, γ -glutamyl-cysteinylglycine, which readily undergoes oxidation to form a disulphide-linked hexapeptide, oxidized glutathione, generally abbreviated to GSSG. **Table 57-3** shows the concentrations of GSH and GSSG in red cells from the patient and 10 control subjects, before and after incubation with acetylphenylhydrazine.

How much GSH is oxidized per mol of acetylphenylhydrazine added?

The reported K_m of glutathione reductase for GSSG is 65 $\mu\text{mol/L}$ and for NADPH 8.5 $\mu\text{mol/L}$. Erythrocyte lysates were incubated with a saturating concentration of GSSG (1 mmol/L) and either NADPH or NADH (100 $\mu\text{mol/L}$). Each incubation contained the hemolysate from 0.5-mL packed cells (**Table 57-4**).

Since none of the red cell lysates showed any significant activity with NADH, it is unlikely that there is any transhydrogenase activity in erythrocytes, to reduce NADP^+ to

TABLE 57-4 Glutathione Reductase, μmol Product Formed/min

	Patient in Case 3	Control Subjects
NADPH	0.64	0.63 ± 0.06
NADH	0.01	0.01 ± 0.001

NADPH at the expense of NADH. This raises the problem of the source of NADPH in erythrocytes.

The dye methylene blue will oxidize NADPH; the reduced dye then undergoes nonenzymic oxidation in air, so the addition of a relatively small amount of methylene blue will effectively deplete NADPH, and would be expected to stimulate any pathway that reduces NADP^+ to NADPH.

Erythrocytes from control subjects were incubated with 10 mmol/L [^{14}C]glucose with or without the addition of methylene blue; all six possible positional isomers of [^{14}C]glucose were used, and the radioactivity in (lactate + pyruvate) was determined after thin layer chromatography of the incubation mixture. Each incubation contained 1 mL erythrocytes in a total incubation volume of 2 mL (**Table 57-5**).

In further studies, only the formation of $^{14}\text{CO}_2$ from [^{14}C -1]glucose was measured, with the addition of:

- Sodium ascorbate (which undergoes a nonenzymic reaction in air to produce H_2O_2)
- Acetylphenylhydrazine (which is known to precipitate hemolysis in sensitive subjects, and depletes reduced glutathione)
- Methylene blue (which oxidizes NADPH)

The incubations were repeated with *N*-ethylmaleimide, which undergoes a nonenzymic reaction with the —SH group of reduced glutathione, and thus depletes the cell of total glutathione. The results are shown in **Table 57-6**.

Further studies showed that the patient's red blood cells contained only about 20% of the normal activity of glucose 6-phosphate dehydrogenase (see Chapter 20). In order to investigate why his enzyme activity was so low, a sample of his red blood cells was incubated at 45°C for 60 minutes, then cooled to 30°C and the activity of glucose 6-phosphate dehydrogenase was determined. After the preincubation at 45°C, his red cells showed only 60% of their initial activity. By contrast, red cells from control subjects retained 90% of their initial activity after preincubation at 45°C for 60 minutes.

What conclusions can you draw from these results?

TABLE 57-3 The Effect of Incubation With 330 $\mu\text{mol/L}$ Acetylphenylhydrazine on Erythrocyte Glutathione

	Patient in Case 3		Control Subjects	
	GSH (mmol/L)	GSSG ($\mu\text{mol/L}$)	GSH (mmol/L)	GSSG ($\mu\text{mol/L}$)
Initial	1.61	400	2.01 ± 0.29	4.2 ± 0.61
+ Acetylphenylhydrazine	0.28	1540	1.82 ± 0.24	190 ± 28

TABLE 57-5 Production of [¹⁴C]lactate, Pyruvate and CO₂ by 1 mL Erythrocytes From Control Subjects Incubated for 1 Hour With 10 mmol/L [¹⁴C]glucose at 10 μCi/mmol

	Control		+ Methylene Blue	
	Lactate + Pyruvate	CO ₂	Lactate + Pyruvate	CO ₂
[¹⁴ C-1]glucose	12680 ± 110	1410 ± 15	1830 ± 20	12260 ± 130
[¹⁴ C-2]glucose	14080 ± 120	ND	14120 ± 120	ND
[¹⁴ C-3]glucose	14100 ± 120	ND	14090 ± 120	ND
[¹⁴ C-4]glucose	14060 ± 120	ND	14080 ± 120	ND
[¹⁴ C-5]glucose	14120 ± 120	ND	14060 ± 120	ND
[¹⁴ C-6]glucose	14090 ± 110	ND	14100 ± 120	ND

ND, not detectable, ie, below the limits of detection.
Figures show dpm, mean ± sd for 5 replicate incubations.

CASE 4

The patient is a 10-year-old Maltese boy. On his birthday his aunt gave him a pie made from fava beans (a local delicacy), and that evening he suffered kidney pain, and passed dark urine. A blood film showed a low red blood cell count and the plasma was red colored. This problem is not uncommon in Malta, and indeed several of his classmates (all boys) have died when an acute crisis has been precipitated by eating fava beans, or after a moderate fever associated with an infection.

Further studies showed that his erythrocyte glucose 6-phosphate dehydrogenase was only 10% of normal and had a very high K_m for NADP⁺. Unlike the patient in case 3, his red blood cell enzyme was as stable to incubation at 45°C as that from control subjects.

What conclusions can you draw from these observations?

CASE 5

The patient is a 28-week-old baby girl. She was admitted to the emergency department in a coma, having suffered a convulsion after feeding. She had a mild infection and slight fever

TABLE 57-6 Production of ¹⁴CO₂ by 1 mL Erythrocytes From Control Subjects Incubated for 1 Hour With 10 mmol /L [¹⁴C-1]glucose at 10 μCi/mmol

Additions	Control	+ <i>N</i> -Ethylmaleimide
None	1410 ± 70	670 ± 30
Ascorbate	8665 ± 300	2133 ± 200
Acetylphenylhydrazine	7740 ± 320	4955 ± 325
Methylene blue	12230 ± 500	11265 ± 450

Figures show dpm, mean ± sd for 5 replicate incubations.

at the time. Since birth she had been a sickly child, and had frequently vomited and become drowsy after feeding. She was bottle-fed and at one time cows' milk allergy was suspected, although the problems persisted when she was fed on soya-milk.

On admission she was mildly hypoglycemic, ketotic and her plasma pH was 7.29. Analysis of a blood sample showed normal levels of insulin, but considerable hyperammonemia (plasma ammonium ion concentration 500 μmol/L; reference range 40-80 μmol/L). She responded well to intravenous glucose infusion and rectal infusion of lactulose, regaining consciousness. She had poor muscle tone.

A liver biopsy sample was taken, and the activities of the enzymes of urea synthesis (see Chapter 28) were determined, and compared with activities in postmortem liver samples from six infants of the same age. The results are shown in Table 57-7. She remained well on a high carbohydrate, low protein diet for several days, although the poor muscle tone and muscle weakness persisted. A second liver biopsy sample was taken after 4 days and the activity of the enzymes determined again.

Her very low protein diet was continued, but in order to ensure an adequate supply of essential amino acids for growth she was fed a mixture of the keto-acids of threonine, methionine, leucine, isoleucine, and valine. After each feed she again became abnormally drowsy and markedly ketotic, with significant acidosis. Her plasma ammonium ion concentration was within the normal range, and a glucose tolerance test was normal, with a normal increase in insulin secretion after glucose load.

High-pressure liquid chromatography of her plasma revealed an abnormally high concentration of propionic acid (24 μmol/L; reference range 0.7-3.0 μmol /L). Urine analysis showed considerable excretion of methylcitrate (1.1 μmol/mg creatinine), which is not normally detectable. She was also excreting a significant amount of short-chain acyl carnitine (mainly propionyl carnitine)—28.6 μmol/24 hours, compared with a reference range of 5.7 + 3.5 μmol/24 hours.

TABLE 57-7 Activity of Enzymes of the Urea Synthesis Cycle in Liver Biopsy Samples From the Patient in Case 5 on Admission and After 4 Days on a High Carbohydrate, Low Protein Diet, Compared With Activities in Postmortem Samples From 6 Infants of the Same Age

	$\mu\text{mol Product Formed/min/mg Protein}$		
	Patient		Control Subjects
	On Admission	After 4 Days	
Carbamoyl phosphate synthetase	0.337	1.45	1.30 ± 0.40
Ornithine carbamyltransferase	29.0	28.6	18.1 ± 4.9
Argininosuccinate synthetase	0.852	0.75	0.49 ± 0.09
Argininosuccinase	1.19	0.95	0.64 ± 0.15
Arginase	183	175	152 ± 56

The metabolism of a test dose of [^{13}C]propionate given by intravenous infusion was determined in the patient, her parents and a group of control subjects; skin fibroblasts were cultured and the activity of propionyl CoA carboxylase was determined by incubation with propionate and $\text{NaH}^{14}\text{CO}_3$, followed by acidification and measurement of the radioactivity in products. The results are shown in **Table 57-8**.

The results of measuring carnitine in the first liver biopsy sample and in a muscle biopsy sample gave the results shown in **Table 57-9**.

What conclusions can you draw from these results?

Can you explain the biochemical basis of the patient's condition?

CASE 6

The patient is a 9-month-old girl, the second child of unrelated parents. She was born at term after an uneventful pregnancy, weighing 3.4 kg and was breast fed, with gradual introduction of solids from 3 months of age onward. Her mother reported that, while she liked cheese, meat, and fish, she frequently became irritable and grizzly after meals, and became lethargic, drowsy, and "floppy" after eating relatively large amounts of protein-rich foods. Her urine had a curious odor, described by her mother as being "cat-like," on such occasions.

TABLE 57-8 Metabolism of [^{13}C]propionate

	Patient in Case 5	Mother	Father	Control Subjects
Percent recovered in $^{13}\text{CO}_2$ over 3 h	1.01	32.6	33.5	65 ± 5
dpm fixed/mg fibroblast protein/30 min	5.0	230	265	561 ± 45

At 9 months of age she was admitted to the emergency department in a coma, and suffering convulsions. She had been unwell for the last 3 days, with a slight fever, and for the last 12 hours had been refusing all food and drink. At this time she weighed 8.8 kg, and her body length was 70.5 cm.

Emergency blood tests revealed moderate acidosis (pH 7.25) and severe hypoglycemia (glucose <1 mmol/L); a dipstick test for plasma ketone bodies was negative. A blood sample was taken for full clinical chemistry tests, and she was given intravenous glucose. Within a short time she recovered consciousness. The results of the blood tests are shown in **Table 57-10**.

She remained in hospital for several weeks, while further tests were performed. She was generally well through this time, but became drowsy and severely hypoglycemic, and hyperventilated, if she was deprived of food for more than about 8 to 9 hours. Her muscle tone was poor, and she was very weak, with considerably less strength (eg, in pushing her arms or legs against the pediatrician's hand) than would be expected for a girl of her age.

On one occasion her blood glucose was monitored at 30-minute intervals over 3 hours from waking, without being fed. It fell from 3.4 mmol/L on waking to 1.3 mmol/L 3 hours later. She was deprived of breakfast again the next day, and again blood glucose was measured at 30-minute intervals for 3 hours during which she received an intravenous infusion of β -hydroxybutyrate (50 $\mu\text{mol/min/kg}$ body weight). During the infusion of β -hydroxybutyrate her plasma glucose remained between 3.3 and 3.5 mmol/L.

At no time were ketone bodies detected in her urine, and there was no evidence of any abnormal excretion of amino acids. However, a number of abnormal organic acids were detected in her urine, including relatively large amounts of 3-hydroxy-3-methylglutaric and 3-hydroxy-3-methylglutamic acids. The excretion of these two acids increased considerably under two conditions:

1. When she was fed a relatively high protein meal (she became grizzly, lethargic, and irritable). A blood sample taken after such a meal showed significant hyperammonemia (130 $\mu\text{mol/L}$), but normal glucose (5.5 mmol/L).

TABLE 57-9 Liver and Muscle Carnitine

$\mu\text{mol/g}$ Weight Tissue	Liver		Muscle	
	Patient in Case 5	Control Subjects	Patient in Case 5	Control Subjects
Total carnitine	0.23	0.83 ± 0.26	1.56	2.29 ± 0.75
Free carnitine	0.05	0.41 ± 0.17	0.29	1.62 ± 0.67
Short-chain acylcarnitine	0.16	0.37 ± 0.20	1.16	0.58 ± 0.32
Long-chain acylcarnitine	0.01	0.05 ± 0.02	0.11	0.09 ± 0.03

2. When she was fasted for more than the normal overnight fast, with or without the infusion of β -hydroxybutyrate.

One obvious metabolic precursor of 3-hydroxy-3-methylglutaric acid is 3-hydroxy-3-methylglutaryl CoA (HMG-CoA), which is normally cleaved to yield acetoacetate and acetyl-CoA by the enzyme hydroxymethylglutaryl CoA lyase (Chapter 22). Therefore the activity of this enzyme was determined in leukocytes from blood samples from the patient and her parents. The results are shown in **Table 57-11**.

Analysis of her urine also revealed considerable excretion of carnitine, as shown in **Table 57-12**.

What is the likely biochemical basis of the patient's problem? To what extent can you account for her various metabolic problems from the information you are given?

What dietary manipulation(s) would be likely to maintain her in good health, and prevent further emergency hospital admissions?

CASE 7

The patient is a 9-month-old boy, the second child of unrelated parents; his brother is 5 years old, fit and healthy. He was born at full term after an uneventful pregnancy, weighing 3.4 kg (the 50th centile), and developed normally until he was 6 months old, after when he showed some retardation of development. He

TABLE 57-10 Clinical Chemistry Results for a Plasma Sample From the Patient in Case 6 on Admission and Reference Range for 24-h Fasting

	Patient in Case 6	Reference Range
Glucose, mmol/L	0.22	4-5
pH	7-25	7-35-7-45
Bicarbonate, mmol/L	11	21-29
Ammonium, $\mu\text{mol/L}$	120	<50
Ketone bodies, mmol/L	undetectable	2.5-3.5
Non-esterified fatty acids, mmol/L	2	1.0-1.2
Insulin, mU/L	5	5-35
Glucagon, ng/mL	140	130-160

also developed a fine scaly skin rash about this time, and his hair, which had been normal, became thin and sparse.

At 9 months of age he was admitted to the emergency department in a coma; the results of clinical chemistry tests on a plasma sample are shown in **Table 57-13**.

The acidosis was treated by intravenous infusion of bicarbonate, and he recovered consciousness. Over the next few days he continued to show signs of acidosis (rapid respiration), and even after a meal ketone bodies were present in his urine. His plasma lactate, pyruvate, and ketone bodies remained high; plasma glucose was in the low normal range, and his plasma insulin was normal both in the fasting state and after an oral glucose load.

Urine analysis revealed the presence of significant amounts of a number of organic acids that are not normally excreted in the urine, including:

- Lactate, pyruvate, and alanine
- Propionate, hydroxypropionate, and propionyl glycine
- Methylcitrate
- Tiglate and tiglylglycine
- 3-Methyl crotonate, 3-methylcrotonylglycine, and 3-hydroxyisovalerate

His skin rash and hair loss were reminiscent of the signs of biotin deficiency (see Chapter 44), as caused by excessive consumption of uncooked egg-white. However, his mother said that he did not eat raw or undercooked eggs at all, although he was fond of hard-boiled eggs and yeast extract (which are rich sources of biotin). His plasma biotin was 0.2 nmol/L (normal >0.8 nmol/L), and he excreted a significant amount of biotin in the form of biocytin (see Figure 44-17) and small biocytin-containing peptides, which are not normally detectable in urine.

He was treated with 5 mg of biotin per day. After 3 days the abnormal organic acids were no longer detectable in his urine, and his plasma lactate, pyruvate, and ketone bodies had

TABLE 57-11 Leukocyte HMG CoA Lyase Activity, nmol Product Formed/min/g Protein

Patient in case 6	1.7
Mother	10.2
Father	11.4
Control subjects	19.7 ± 2.0

TABLE 57-12 Urinary Excretion of Carnitine, nmol/mg Creatinine

	Patient in Case 6	Reference Range
Total carnitine	680	125 ± 75
Free carnitine	31	51 ± 40
Acyl carnitine	649	74 ± 40

returned to normal, although his excretion of biocytin and biocytin-containing peptides increased. At this stage he was discharged from hospital, with a supply of biotin tablets. After 3 weeks his skin rash began to clear, and his hair loss ceased.

Three months later, at a regular out-patient visit, it was decided to cease the biotin supplements. Within a week the abnormal organic acids were again detected in his urine, and he was treated with varying doses of biotin until the organic aciduria ceased. This was achieved at an intake of 150 µg/d (compared with the reference intake of 10-20 µg/d for an infant under 2 years old).

He has continued to take 150 µg of biotin daily, and has remained in good health for the last 4 years.

Can you account for the biochemical basis of the patient's problem?

CASE 8

The patient is a 4-year-old girl, the only child of nonconsanguineous parents, born at term after an uneventful pregnancy. At 14 months of age she was admitted to hospital with a 1-day

TABLE 57-13 Clinical Chemistry Results for a Plasma Sample From the Patient in Case 7 on Admission and Reference Range for 24-Hour Fasting

	Patient in Case 7	Reference Range
Glucose, mmol/L	3.3	3.5-5.5
pH	6.9	7.35-7.45
Bicarbonate, mmol/L	2.0	21-25
Ketone bodies, mmol/L	21	1-2.5
Lactate, mmol/L	7-3	0.5-2.2
Pyruvate, mmol/L	0.31	<0.15

history of persistent vomiting, rapid shallow respiration, and dehydration. On admission, her respiration rate was 60/minute and her pulse 178/minute. The first column in **Table 57-14** shows the results of clinical chemistry tests at that time. She responded rapidly to intravenous bicarbonate and a single intramuscular injection of insulin.

The results of a glucose tolerance test 3 days after admission were normal, and her plasma insulin response to an oral glucose load was within the normal range. She was discharged from hospital 7 days after admission, apparently fit and well. The second column in **Table 57-14** shows the results of clinical chemistry tests taken shortly before her discharge.

She was readmitted to hospital at 16, 25, 31, and 48 months of age, suffering from restlessness, unsteady gait, rapid shallow respiration, persistent vomiting, and dehydration. Each time the crisis was preceded by a common childhood illness and

TABLE 57-14 Clinical Chemistry Results for Plasma and Urine Samples From the Patient in Case 8 on Admission and Again 1 Week Later

	Acute Admission	1 Week Later	Reference Range
Plasma			
Glucose, mmol/L	14	5.1	3.5-5.5
Sodium, mmol/L	132	137	135-145
Chloride, mmol/L	111	105	100-106
Bicarbonate, mmol/L	1.5	20	21-25
Urea, mmol/L	4.1	4.9	2.9-8.9
Lactate, mmol/L	7-3	5.5	0.5-2.2
Pyruvate, mmol/L	0.31	0.25	<0.15
Alanine, mmol/L	-	852	99-313
Aspartate, mmol/L	-	Undetectable	3-11
pH	6.89	7-36	7.35-7.45
Urine			
Lactate, mg/g creatinine	-	1.48	<0.1
Ketone bodies, using Ketostix	Very high	Negative	Negative

TABLE 57-15 Activities of Mitochondrial Enzymes From Cultured Skin Fibroblasts (nmol product formed/min/mg protein)

	Patient in Case 8	Control Subjects
Citrate synthase	32.8	76.3 ± 15.1
Cytochrome c reduction by NADH	11.6	16.7 ± 4.6
Cytochrome c reduction by succinate	9.43	12.3 ± 3.2
Cytochrome oxidase	37-7	50.3 ± 11.6
NADH dehydrogenase	633	910 ± 169
Pyruvate carboxylase	0.03	1.62 ± 0.39
Pyruvate dehydrogenase	1.86	1.72 ± 0.35
Succinate oxidase	190	210 ± 30

decreased appetite, and she responded well to intravenous fluids and bicarbonate. A number of milder episodes were treated at home by oral fluid and bicarbonate.

During her admission at age 25 months, a skin biopsy was taken, fibroblasts were cultured, and the mitochondrial enzyme activities shown in Table 57-15 were determined.

Can you explain the biochemical basis of the patient's condition?

CASE 9

The patient is a 5-year-old boy who is diabetic. There is a family history of diabetes, which strongly suggests a dominant pattern of inheritance. He secretes a significant amount of insulin, although less than normal subjects, suggesting that the problem is not type 1 diabetes. Unlike type 2 diabetes, this condition develops in early childhood, and is generally referred to as maturity-onset diabetes of the young (MODY).

The results of studies of the secretion of insulin by rabbit pancreas incubated in vitro with two concentrations of glucose, with and without the addition of the 7-carbon sugar mannoheptulose, which is an inhibitor of the phosphorylation of glucose to glucose-6-phosphate are shown in Table 57-16.

Two enzymes catalyze the formation of glucose 6-phosphate from glucose (see Chapter 17):

- Hexokinase is expressed in all tissues; it has a K_m for glucose of ~0.15 mmol/L

TABLE 57-16 Secretion of Insulin ($\mu\text{g}/\text{minute}/\text{incubation}$) by Rabbit Pancreas In Vitro

	Control	+ Mannoheptulose
3.3 mmol/L glucose	3.5	3.5
16.6 mmol/L glucose	12.5	3.5

Source: From data reported by Coore HG, Randle PJ: Biochemical J 1964;93:66-77.

- Glucokinase is expressed only in liver and the β -cells of the pancreas; it has a K_m for glucose of ~20 mmol/L

The normal range of plasma glucose is between 3.5 and 5 mmol/L, rising in peripheral blood to 8 to 10 mmol/L after a moderately high intake of glucose. After a meal, the concentration of glucose in the portal blood, coming from the small intestine to the liver, may be considerably higher than this.

- What effect will changes in the plasma concentration of glucose have on the rate of formation of glucose-6-phosphate catalyzed by hexokinase?
- What effect will changes in the plasma concentration of glucose have on the rate of formation of glucose-6-phosphate catalyzed by glucokinase?
- What is the importance of glucokinase in the liver?

Froguel and coworkers (1993) reported studies of the glucokinase gene in a number of families affected by MODY, and also in unaffected families. They published a list of 16 variants of the glucokinase gene, shown in Table 57-17. All their patients with MODY had an abnormality of the gene.

- What are the amino acid changes associated with each mutation in the gene?
- Why do the mutations affecting codons 4, 10, and 116 have no effect on the people involved?
- What conclusions can you draw from this information?

TABLE 57-17 Mutations in the Glucokinase Gene

Codon	Nucleotide Change	Amino Acid Change	Effect
4	GAC \Rightarrow AAC	?	None
10	GCC \Rightarrow GCT	?	None
70	GAA \Rightarrow AAA	?	MODY
98	CAG \Rightarrow TAG	?	MODY
116	ACC \Rightarrow ACT	?	None
175	GGA \Rightarrow AGA	?	MODY
182	GTG \Rightarrow ATG	?	MODY
186	CGA \Rightarrow TGA	?	MODY
203	GTG \Rightarrow GCG	?	MODY
228	ACG \Rightarrow ATG	?	MODY
261	GGG \Rightarrow AGG	?	MODY
279	GAG \Rightarrow TAG	?	MODY
300	GAG \Rightarrow AAG	?	MODY
300	GAG \Rightarrow CAG	?	MODY
309	CTC \Rightarrow CCC	?	MODY
414	AAG \Rightarrow GAG	?	MODY

Source: From data reported by Froguel P, et al: N Engl J Med 1993;328:697-702.

TABLE 57-18 Plasma Concentrations of Glucose and Insulin Before and After 60 Minutes of Glucose Infusion

	Plasma glucose (mmol/L)		Insulin (mU/L)	
	Patients with MODY	Control subjects	Patients with MODY	Control subjects
Fasting	7.0 ± 0.4	5.1 ± 0.3	5 ± 2	6 ± 2
60 min glucose infusion	Maintained at 10 mmol/L by varying rate of infusion		12 ± 7	40 ± 11

Source: From data reported by Froguel P, et al: N Engl J Med 1993;328:697-702.

The same authors also studied the secretion of insulin in response to glucose infusion in patients with MODY and control subjects. They were given an intravenous infusion of glucose; the rate of infusion was varied so as to maintain a constant plasma concentration of glucose of 10 mmol/L. Their plasma concentrations of glucose and insulin were measured before and after 60 minutes of glucose infusion; the results are shown in **Table 57-18**.

- **What conclusions can you draw from this information about the probable role of glucokinase in the β -cells of the pancreas?**
- **Can you deduce the way in which the β -cells of the pancreas sense an increase in plasma glucose and signal the secretion of insulin?**

The Biochemistry of Aging

Peter J. Kennelly, PhD

OBJECTIVES

After studying this chapter, you should be able to:

- Describe the essential features of wear and tear theories of aging.
- List at least four common environmental factors known to damage biological macromolecules such as proteins and DNA.
- Describe why nucleotide bases are especially vulnerable to damage.
- Describe the most physiologically important difference between mitochondrial and nuclear genomes.
- Describe the oxidative theory of aging and name the primary sources of reactive oxygen species (ROS) in humans.
- Describe three mechanisms by which cells prevent or repair damage inflicted by ROS.
- Describe the basic tenets of metabolic theories of aging.
- Describe the mechanism of the telomere “countdown clock.”
- Describe our current understanding of the genetic contribution to aging.
- Explain the evolutionary implications of a genetically encoded lifespan.

BIOMEDICAL IMPORTANCE

Consider the various stages in the lifespan of *Homo sapiens*. Infancy and childhood are characterized by continual growth in height and body mass. Basic motor and intellectual skills develop: walking, language, etc. Infancy and childhood also represent a period of vulnerability wherein a youngster is dependent on adults for water, food, shelter, protection, and instruction. Adolescence witnesses a final burst of growth in the body’s skeletal framework. More importantly, a series of dramatic developmental changes occur—an accumulation of muscle mass, loss of residual “baby fat,” maturation of the gonads and brain tissue, and the emergence of secondary sex characteristics—that transform the dependent child into a strong, independent, and reproductively capable adult. Adulthood, the longest stage, is a period devoid of dramatic physical growth or developmental change. With the notable exception of pregnancy in females, it is not unusual for adults to maintain the same body weight, overall appearance, and general level of activity for two or three decades.

Barring fatal illness or injury, the onset of the final stage of life, old age, is signaled by a resurgence of physical and physiological change. Hair begins to noticeably thin, turning white or gray as it loses its pigmentation. Skin loses its suppleness and accumulates blemishes. Individuals appear to shrink as both muscle and bone mass are progressively lost. Attention span and recall decline. Eventually, inevitably, life itself comes to an end as one or more essential bodily functions decline.

Understanding the underlying causes and instigating triggers of aging and the changes that accompany it is of great biomedical importance. Hutchison-Gilford, Werner, and Down syndrome are three human genetic diseases whose pathologies include an acceleration of many of the physiological events associated with aging. Slowing or stopping some of the degenerative processes that cause or accompany aging can render the last stage of life much more vital, productive, and fulfilling. Co-opting the factors responsible for triggering cell death may enable physicians to selectively destroy harmful tissues and cells such as tumors, polyps, and cysts without collateral damage to healthy tissues.

LIFESPAN VERSUS LONGEVITY

From Paleolithic times through Greece's Golden Age to Medieval times the average life expectancy for a newborn baby remained relatively constant, oscillating within the range of 25 to 35 years. Beginning with the Renaissance, this number has gradually increased, so that by the beginning of the 20th century the average life expectancy of persons born in developing countries reached the mid-40s. Today, 100 years later, the current world average is 67 years, and that for developed nations is approaching 80. This has led to speculation in the popular press with regard how long this trend might be expected to continue. Can future generations expect to live past the century mark? Is it possible that human beings possess the potential, barring accidents and with proper care and maintenance, to live indefinitely?

Unfortunately, this extrapolation is unlikely to be realized because it is based on a misunderstanding of the term **life expectancy**. Life expectancy is calculated by averaging over all births. Hence, it is dramatically influenced by infant mortality rates. While the life expectancy of a Roman child was 25 years, if one calculated the expected lifespan only for those persons who survived infancy, which we will refer to as **longevity**, the average nearly doubled to 48. When one factors out the dramatic decline in infant mortality rates that has taken place over the past century and a half, the apparent doubling in the human lifespan largely, *but not entirely*, disappears. As can be seen in **Table 58-1**, the predicted longevity of a 5-year-old child in the United States has increased from 70.5 in 1950 to 77.5 years in 2000. Is there some sort of upper limit to the lifespan of a properly nourished, well-maintained human being? Perhaps not.

TABLE 58-1 Average Life Expectancy by Decade, USA

Sample Period	Average Life Expectancy (Years)	
	From Birth	If Survived to Age 5
1900-1902	49.24	59.98
1909-1911	51.49	61.21
1919-1921	56.40	62.99
1929-1931	59.20	64.29
1939-1941	63.62	67.49
1949-1951	68.07	70.54
1959-1961	69.89	72.04
1969-1971	70.75	72.43
1979-1981	73.88	75.00
1989-1991	75.37	76.22
1999-2001	76.83	77.47

Source: Adapted from Table 12 of the *National Vital Statistics Reports* (2008) 57, vol. 1.

AGING & MORTALITY: NONSPECIFIC OR PROGRAMMED PROCESSES?

Are aging and death nondeterminant or **stochastic** processes in which living creatures inevitably reach a tipping point where they succumb to a lifetime's accumulation of damage from disease, injury, and simple wear and tear? While the human body has a certain capacity to repair and replace at the molecular and cellular levels, this capacity is variable and finite. No matter how much attention is devoted to care and maintenance, like an automobile or some other sophisticated mechanical device, sooner or later some key component of our bodies will wear out. An alternative school of thought posits that aging and death are genetically programmed processes analogous to puberty, which have evolved through a process of natural selection.

Aging and death are, in all likelihood, multifactorial processes to which numerous factors, some nondeterminant and others programmed, make important contributions. While much work remains to be done before the precise makeup of this mechanistic mosaic can be determined, a large range of potential contributors have been identified. Several of the more prominent of these are presented in the sections that follow.

WEAR & TEAR THEORIES OF AGING

Many theories regarding aging and mortality hypothesize that the human body eventually succumbs to the accumulation of damage over time as a result of long-term exposure to a variety of environmental factors that are reactive with organic biomolecules. These theories note that while repair and turnover mechanisms exist to restore or replace many classes of damaged molecules, these mechanisms are less than perfect. Hence, some damage inevitably leaks through—damage that will accumulate over time, particularly in long-lived cell populations that experience little, if any, turnover (**Table 58-2**). Ironically, many of the agents that are most damaging to proteins, DNA, and other biomolecules are also essential for terrestrial life: water, oxygen, and sunlight.

Hydrolytic Reactions Can Damage Proteins & Nucleotides

Water is a relatively weak nucleophile. However, because of its ubiquity and high concentration (>55 M, see Chapter 2), even this weak nucleophile will react with susceptible targets inside the cell. In proteins, hydrolysis of peptide bonds leads to cleavage of the polypeptide chain. The amide bonds most frequently targeted by water are those found on the side chains of the amino acids asparagine and glutamine, presumably because they are more exposed, on average, to solvent than the

TABLE 58-2 Time Required for All of the Average Cells of This Type to Be Replaced

Tissue or Cell Type	Turnover
Intestinal epithelium	34 h ^a
Epidermis	39 d ^b
Leukocyte	<1 y ^c
Adipocytes	9.8 y ^c
Intercostal skeletal muscle	15.2 y ^c
Cardiomyocytes	≥100 y ^c

Source: Data from:

^aPotten CS, Kellert M, Rew DA, et al: Proliferation in human gastrointestinal epithelium using bromodeoxyuridine in vivo. *Gut* 1992;33:524.

^bWeinstein GD, McCullough JL, Ross P: Cell proliferation in normal epidermis. *J Invest Dermatol* 1984;82:623.

^cSpalding KL, Arner E, Westermark PO, et al: Dynamics of fat cell turnover in humans. *Nature* 2008;453:783.

amide bonds in the protein's backbone. Hydrolysis leads to the replacement of the neutral amide group with an acidic carboxylic acid group, forming aspartate and glutamate, respectively

(Figure 58-1A and B). This change introduces both a negative charge and a potential proton donor or acceptor to the affected region of the protein. As the protein population within a living organism is subject to continual turnover, in most cases the chemically modified protein will be degraded and replaced by a newly synthesized protein.

Of perhaps greater potential biological consequence are the reactions of the nucleotide bases in DNA with water. The amino groups projecting from the heterocyclic aromatic rings of the nucleotide bases cytosine, adenine, and guanine are each susceptible to hydrolytic attack. In each case, the amino group is replaced by a carbonyl to form uracil, hypoxanthine, and xanthine, respectively (Figure 58-1C). If the affected base is located in the cell's DNA, the net result is a mutation that, if left unrepaired, can potentially perturb gene expression or generate a dysfunctional gene product. The bond between the nucleotide base and the deoxyribose moiety in DNA is also vulnerable to hydrolysis. In this instance the base is completely eliminated, leaving a gap in the sequence (Figure 58-1D) which, if left unrepaired, can lead to either a substitution or a frame-shift mutation (see Chapter 37).

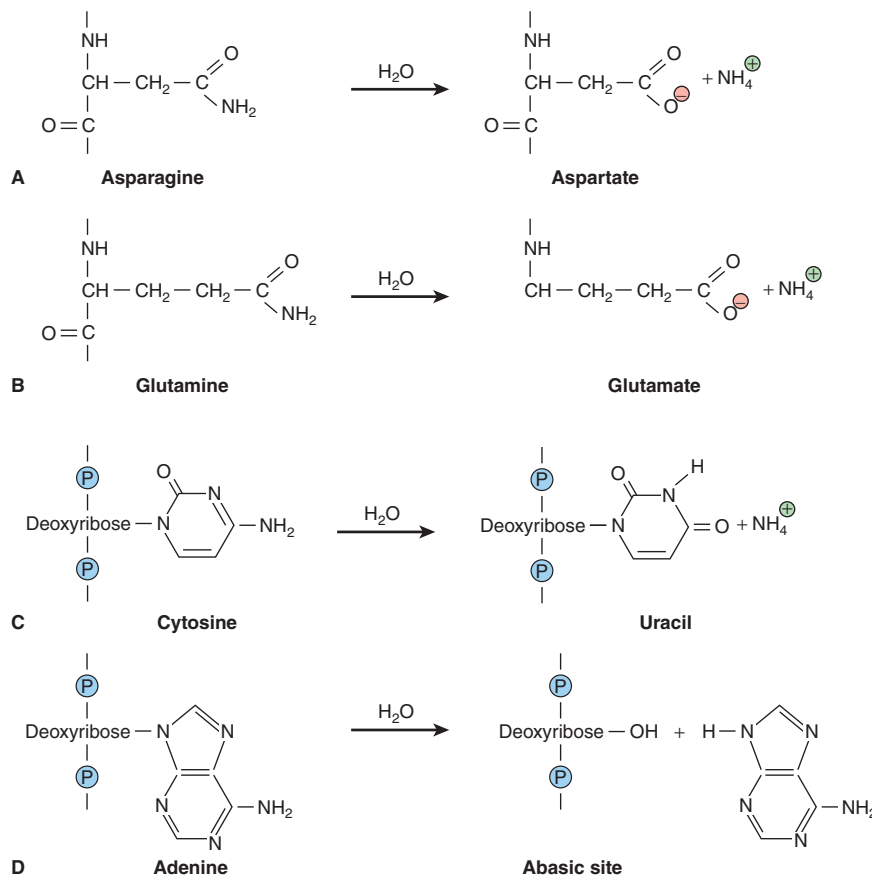
**FIGURE 58-1 Examples of hydrolytic damage to biological macromolecules.**

Shown are a few of the ways in which water can react with and chemically alter proteins and DNA: **(A)** Net substitution of aspartic acid via hydrolytic deamidation of the neutral side chain of asparagine. **(B)** Net substitution of glutamic acid via hydrolytic deamidation of the neutral side chain of glutamine. **(C)** Net mutation of cytosine to uracil by water. **(D)** Formation of an abasic site in DNA via hydrolytic cleavage of a ribose-base bond.

Many other bonds within biological macromolecules constitute potential targets for random chemical hydrolysis. Included in this list are the ester bonds that bind fatty acids to their cognate glycerolipids, the glucosidic bonds that link the monosaccharide units of carbohydrates, and the phosphodiester bonds that hold polynucleotides together and link the head groups of phospholipids to their diacylglycerol partners. However, these reactions appear to take place too infrequently (eg hydrolysis of phosphodiester bonds within the backbone of DNA and RNA) or to generate insufficiently perturbing products to manifest significant biological consequences.

Respiration Generates Reactive Oxygen Species

Numerous biological processes require enzyme-catalyzed oxidation of organic molecules by molecular oxygen (O_2). These processes include the hydroxylation of proline and lysine side chains in collagen (see Chapter 5), the detoxification of xenobiotics by cytochrome P450 (see Chapter 47), the degradation of purine nucleotides to uric acid (see Chapter 33), the reoxidation of the prosthetic groups in the flavin-containing enzymes that catalyze oxidative decarboxylation (eg, the pyruvate dehydrogenase complex, see Chapter 17) and other redox reactions (eg, amino acid oxidases, see Chapter 28), and the generation of the chemiosmotic gradient in mitochondria by the electron transport chain (see Chapter 13). Redox enzymes frequently employ prosthetic groups such as flavin nucleotides, iron-sulfur centers, or heme-bound metal ions (see Chapters 12 and 13) to assist in the difficult task of generating and stabilizing the highly reactive free radical and oxyanion intermediates formed during these processes. The electron transport chain employs specialized carriers such as ubiquinone and cytochromes to safely transport individual, unpaired electrons among and within its various multiprotein complexes.

Occasionally, these highly reactive intermediates escape into the cell in the form of ROS such as superoxide and hydrogen peroxide (Figure 58–2A). By virtue of its structural and functional complexity and extremely high level of electron flux, “leakage” from the electron transport chain constitutes by far and away the major source of ROS in most mammalian cells. In addition, many mammalian cells synthesize and release the second messenger nitric oxide (NO^*), which contains an unpaired electron, to promote vasodilation and muscle relaxation in the cardiovascular system (see Chapter 51).

Reactive Oxygen Species Are Chemically Prolific

The extremely high reactivity of ROS makes them extremely dangerous. ROS can react with and chemically alter virtually any organic compound, including proteins, nucleic acids, and lipids. Some reactions lead to the cleavage of covalent bonds. ROS also display a strong tendency to form **adducts**—a term referring to the product formed when two compounds combine together—with nucleotide bases, polyunsaturated fatty

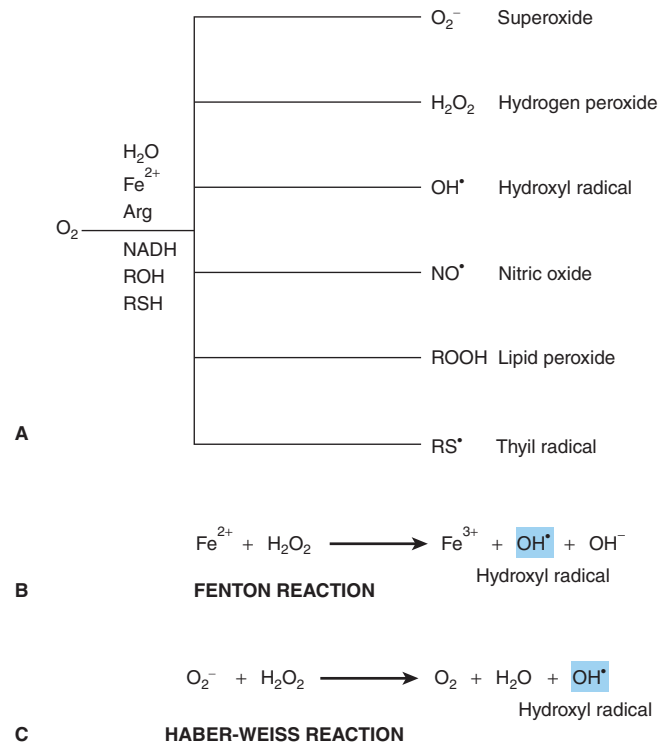

FIGURE 58–2 Reactive oxygen species (ROS) are toxic by-products of life in an aerobic environment. (A) Many types of ROS are encountered in living cells. (B) Generation of hydroxyl radical via the Fenton reaction. (C) Generation of hydroxyl radical by the Haber-Weiss reaction.

acids, and other biological compounds possessing multiple double bonds (Figure 58–3). Adducts formed with nucleotide bases can be especially dangerous because of their potential, if uncorrected, to cause misreads during replication that introduce mutations into DNA.

The ease with which oxygen evokes the chemical changes that turn household butter rancid is a testament to the reactivity of unsaturated fats, those containing one or more carbon-carbon double bond (see Chapter 23) with ROS. Lipid peroxidation can lead to the formation of cross-linked lipid-lipid and lipid-protein adducts and a loss of membrane fluidity and integrity. Loss of membrane integrity, in turn, can—in the case of the mitochondria—undermine the efficiency with which the electron transport chain converts reducing equivalents to ATP, leading to greater production of deleterious ROS. Loss of mitochondrial membrane integrity can also trigger **apoptosis**, the programmed death of a cell.

Chain Reactions Multiply the Destructiveness of ROS

The destructiveness inherent in the high reactivity of many of ROS, particularly free radicals, is exacerbated by their capacity to participate in chain reactions in which the product of the reaction between the free radical and some biomolecule is a damaged biomolecule and another species containing a highly reactive unpaired electron. The chain will terminate when a

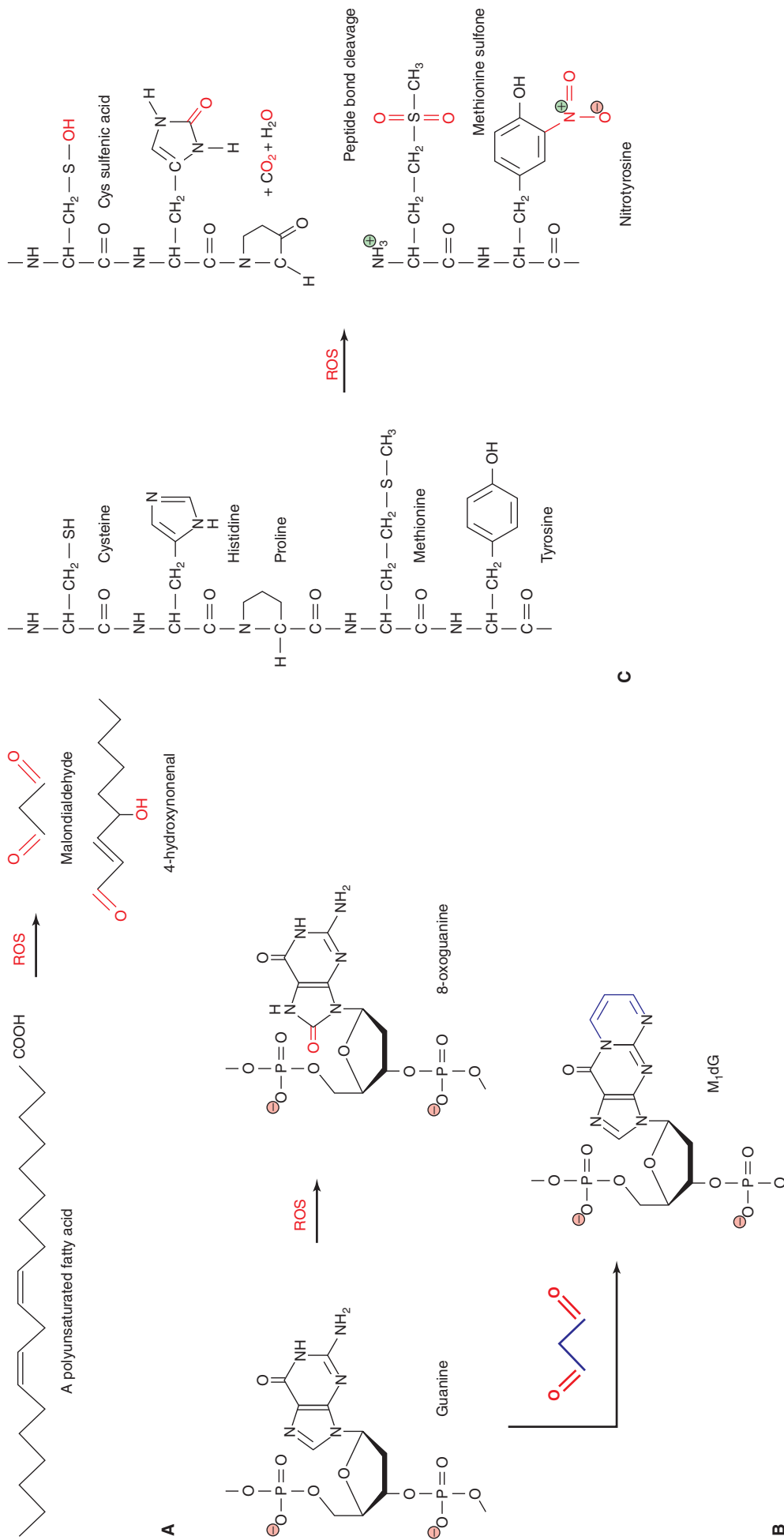

FIGURE 58-3 ROS react directly and indirectly with a wide range of biological molecules. (A) Peroxidation of unsaturated lipids generates reactive products such as malondialdehyde and 4-hydroxynonenal. **(B)** Guanine can be directly oxidized by ROS to produce 8-oxoguanine or form an adduct, M_1dG , with the ROS product malondialdehyde. **(C)** Common reactions of proteins with ROS, including oxidation of amino acid side chains and cleavage of peptide bonds. Oxygen atoms derived from ROS are marked in red. Carbon atoms derived from malondialdehyde in M_1dG are colored blue. The complete chemical name for M_1dG is 3-(2-Deoxy-D-erythro-pentofuranosyl)pyrimido(1,2- α)purin-10(3H)-one.

free radical is able to acquire another lone electron to form a relatively innocuous electron pair without generating a new unpaired electron as a by-product. Such is the case when one free radical encounters another. The two “odd” electrons combine to form a pair. Alternatively, the ROS may be eliminated by one of the cell’s suite of dedicated antioxidant enzymes (see Chapters 12 and 53).

The reactivity, and hence destructiveness, of individual ROS varies. Hydrogen peroxide, for example, is less reactive than superoxide, which in turn is less reactive than hydroxyl radical (OH^\bullet). Unfortunately, two pathways exist in living organisms by which highly toxic hydroxyl radical can be generated from less destructive ROS. If ferric iron is present, for example, the Fenton reaction can transform hydrogen peroxide into hydroxyl radicals (Figure 58–2B). The ferrous (+3) iron, in turn, can be reduced back to the ferric (+2) state by other hydrogen peroxide molecules, permitting the iron to act catalytically to produce additional hydroxyl radicals. Hydroxyl radical can also be generated when superoxide and hydrogen peroxide disproportionate, a process called the Haber-Weiss reaction (Figure 58–2C).

Free Radicals & the Mitochondrial Theory of Aging

In 1956, Denham Harmon proposed the so-called free radical theory of aging. It had been reported that the toxicity of hyperbaric oxygen treatment and radiation could be explained by a factor common to both, the generation of ROS. This report dovetailed nicely with Harmon’s own observation that lifespan was inversely related to metabolic rate and, by extrapolation, respiration. He therefore postulated that the cumulative damage was caused by the continual and inescapable production of ROS.

In more recent years, the proponents of the free radical theory of aging have focused attention on the mitochondria. Not only is the mitochondria host to the major source of ROS in the cell, the electron transport chain, but oxidative damage to the components of this pathway could lead to increased leakage of hydrogen peroxide, superoxide, etc, into the cytoplasm. Damage to the mitochondria would be likely to adversely affect the efficiency with which it performs its most important function, the synthesis of ATP. A significant slowing in the rate of ATP synthesis could readily lead to the types of wholesale declines in physiological function that occur in aging.

A second contributor to the proposed self-perpetuating cycle of mitochondrial redox damage is the fact that several components of the electron transport chain are encoded by the mitochondrion’s indigenous genome. The mitochondrial genome is a much reduced, vestigial remnant of the genome of the ancient bacterium that was the precursor of the current organelle. Through a process called **endosymbiosis**, primitive eukaryotes became dependent upon surrounding bacteria to provide certain materials, and vice versa. Eventually, the smaller bacterium was absorbed by and lived within the interior of its eukaryotic host. Over time most, but not all, of the genes contained in the bacterial genome were either eliminated

TABLE 58–3 Genes Encoded by the Genome of Human Mitochondria

rRNA	12S, 16S rRNA
tRNA	22 tRNAs (2 for Leu and Ser)
Subunits of NADH-ubiquinone oxidoreductase (Complex I, >40 total)	ND 1-6, ND 4L
Subunits of ubiquinol-cytochrome c oxidoreductase (Complex III, 11 total)	Cytochrome b
Subunits of cytochrome oxidase (Complex IV, 13 total)	COX I, COX II, COX III
Subunits of the F_1F_0 ATPase (ATP synthase, 12 total)	ATPase 6, ATPase 8

as superfluous to the needs of the new fusion organism or were transferred into the host cell’s nuclear DNA. At present, the genome of the human mitochondrion encodes a small and a large ribosomal RNA, 22 tRNAs, and certain polypeptide subunits for complexes I, III, and IV of the electron transport chain as well as the F_1F_0 ATPase (Table 58–3). The mitochondrial genome lacks the surveillance and repair mechanisms that help maintain the integrity of nuclear DNA. Hence, mutations induced by adducts or reaction with ROS, and any functional defects resulting from these mutations, become a permanent feature of each individual mitochondrion’s genome, which will continue to accumulate mutations with time.

While the mitochondrial hypothesis is no longer viewed as providing a unifying explanation for all of the changes that are associated with human aging and its comorbidities, it likely is an important contributor. Powerful circumstantial evidence for this is provided by the central role played by this organelle in the sensor-response pathways that trigger apoptosis.

Mitochondria Are Key Participants in Apoptosis

Apoptosis imbues higher organisms with the ability to selectively eliminate cells that are rendered superfluous by developmental changes, such as those that take place on a continual basis during embryogenesis, or which have been damaged beyond repair. During developmental tissue remodeling, the apoptotic cell death program is triggered by receptor-mediated signals. In the case of damaged cells, any one of several interior indicators may serve as trigger: ROS, viral dsRNA, DNA damage, and heat shock. These signals induce the opening of the permeability transition pore complex embedded in the mitochondrial outer membrane, through which molecules of the small (≈ 12.5 kDa) electron carrier protein cytochrome c then escape into the cytoplasm. Here, cytochrome c serves as the core for nucleating a multiprotein complex, the apoptosome, that initiates a cascade of proteolytic activation events targeting the proenzyme forms of a set of cysteine proteases known as caspases. The terminal caspases, numbers 3 and 7, break down structural proteins in the cytoplasm and chromatin proteins in the nucleus; events that lead to the death of the affected cell and

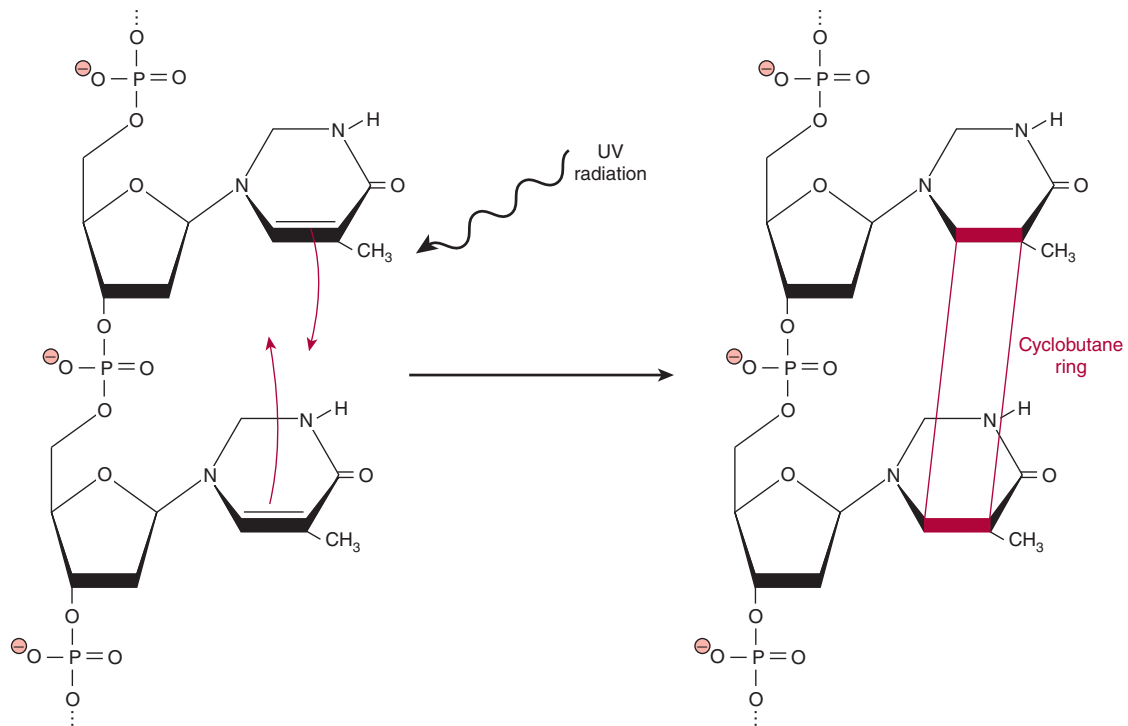

FIGURE 58-4 Formation of a thymine dimer following excitation by UV light. When consecutive thymine bases are stacked one above the other in a DNA double helix, absorption of UV light can lead to the formation of a cyclobutane ring (red, not to scale) covalently linking the two bases together to form a thymine dimer.

its elimination by phagocytosis. Needless to say, the presence of an intrinsic, receptor-mediated cell death pathway offers the hope that we can eliminate harmful cells, such as cancer, by selectively activating their apoptotic pathway.

Ultraviolet Radiation Can Be Extremely Damaging

The term **ultraviolet (UV) radiation** refers to those wavelengths of light that lie immediately beyond the blue or short wavelength end of the visible spectrum. While the human eye cannot detect these particular wavelengths of light, they are strongly absorbed by organic compounds possessing aromatic rings or multiple, conjugated double bonds such as the nucleotide bases of DNA and RNA; the aromatic side chains of the amino acids phenylalanine, tyrosine, and tryptophan; polyunsaturated fatty acids; heme groups; and cofactors and coenzymes such as flavins, cyanocobalamin, etc. Absorption of this short wavelength, high-energy light can cause the rupture of covalent bonds in proteins, DNA, and RNA; the formation of thymine dimers in DNA (**Figure 58-4**); cross-linking of proteins; and the generation of free radicals including ROS. While UV radiation does not penetrate beyond the first few layers of skin cells, the high efficiency of absorption leads to the rapid accumulation of damage among the limited population of skin cells that are impacted. Because the nucleotide bases of DNA and RNA are particularly effective at absorbing UV radiation, it is highly mutagenic. Prolonged exposure to intense sunlight can lead to the accumulation of multiple DNA

lesions that can overwhelm a cell's intrinsic repair capacity. It is thus relatively common for persons whose work or lifestyle involves prolonged exposure to sunlight to manifest aberrant skin tissue, in the form of both moles and cancerous myelomas. Many of the latter can proliferate and spread with great rapidity, necessitating careful surveillance and rapid medical intervention.

Protein Glycation Often Leads to the Formation of Damaging Cross-links

When amino groups such as those found on the side chain of lysine or some of the nucleotide bases are exposed to a reducing sugar such as glucose, a reversible adduct is slowly generated through the formation of a Schiff's base between the aldehyde or ketone group of the sugar and the amine. Over time, the glycated protein undergoes a series of rearrangements to form **Amadori** products, which contain a conjugated carbon-carbon double bond that can react with the amino group on a neighboring protein (**Figure 58-5**). The net result is the formation of a covalent crosslink between two proteins or other biological macromolecules that can, in turn, undergo further glycation and crosslink to yet another macromolecule. These cross-linked aggregates are sometimes called **advanced glycation endproducts** or **AGEs**.

The physiological impact of protein glycation can be especially pronounced when long-lived proteins such as collagen or β -crystallins are involved. Their persistence provides the opportunity for multiple glycation and cross-linking events to

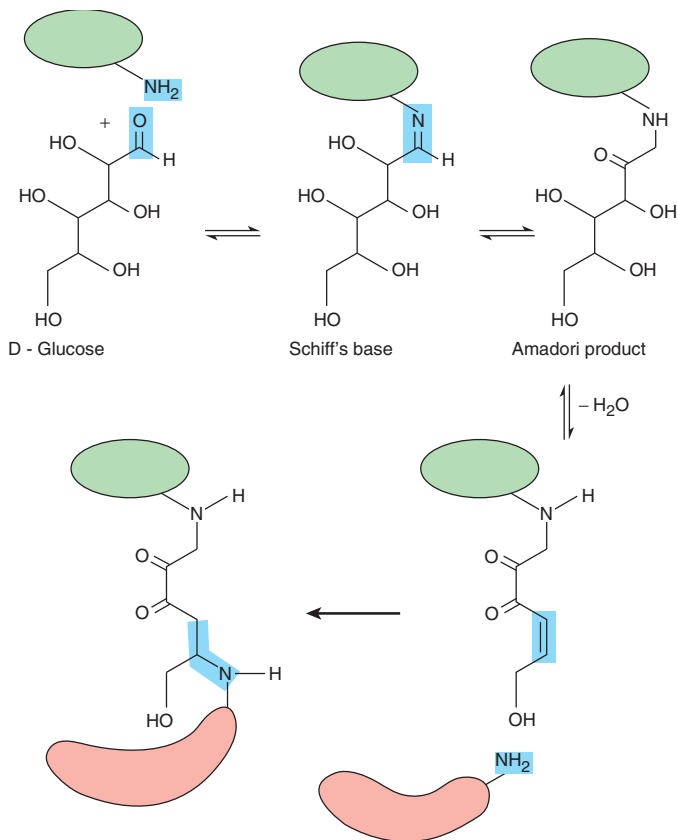

FIGURE 58-5 Protein glycation can lead to the formation of protein-protein cross-links. Shown are the sequence of reactions that generate the Amadori product on the surface of the protein marked in green, and the subsequent formation of a protein-protein crosslink via an amino group on the surface of a second, red, protein.

occur. The progressive cross-linking of the collagen network in vascular endothelial cells leads to the progressive loss of elasticity and thickening of the basement membrane in blood vessels, promoting plaque formation. The overall result is a progressive increase in the heart's workload. In the eye, the accumulation of aggregated proteins compromises the opacity of the lens and eventually manifests itself in the form of cataracts. Impairment of glucose homeostasis renders diabetics particularly susceptible to the formation of advanced glycation end products. In fact, the glycation of hemoglobin and serum albumin are used as biomarkers for the diagnosis of diabetes and the assessment of its treatment.

MOLECULAR REPAIR MECHANISMS COMBAT WEAR & TEAR

Enzymatic & Chemical Mechanisms Intercept Damaging ROS

A corollary to the wear and tear theory of aging is that longevity reflects the effectiveness and robustness of the molecular prevention, repair, and replacement mechanisms in a given

species and the individuals within it. Enzymes such as superoxide dismutase and catalase protect the cell by converting superoxide and hydrogen peroxide, respectively, to less reactive products, thereby preventing potential molecular damage before it occurs (see Chapter 53). For example, fruit flies that have been genetically altered to express elevated levels of superoxide dismutase exhibit significantly extended life spans.

In the cytoplasm, the cysteine-containing tripeptide glutathione acts as a chemical redox protectant by reacting directly with ROS to generate less reactive compounds such as water. Oxidized glutathione, which consists of two tripeptides linked by an S-S bond, is then enzymatically reduced to maintain the pool of protectant (see Chapter 53). Glutathione can also react directly with cysteine sulfenic acids and disulfides on proteins to restore them to their reduced state, and form adducts with toxic xenobiotics (see Chapter 47). Other biomolecules such as ascorbic acid and vitamin E also possess antioxidant properties, which accounts for the fact that many “popular” diets target foods rich in these compounds in an effort to buttress the body's ability to neutralize ROS and slow aging.

The Integrity of DNA Is Maintained by Proofreading & Repair Mechanisms

In addition to the prophylactic measures mentioned above, living organisms possess a limited capacity to replace or repair damaged macromolecules. The majority of this capacity is directed toward maintaining the integrity of the nuclear (but not the mitochondrial) genome, which is to be expected given DNA's unique information storage function, the vulnerability of heterocyclic aromatic nucleotide bases to chemical assault and UV radiation, and the fact that—by contrast to almost every other macromolecule—each human cell contains only one or two copies of each chromosome. A **somatic cell** is one that forms part of the body of an organism. Maintaining the integrity of the genome begins at replication, where careful proofreading is performed to ensure that the new genome formed during somatic cell division faithfully replicates the template that directed its synthesis. In addition, most living organisms possess an impressive cadre of enzymes whose role is to inspect and correct aberrations that either escaped proofreading or were subsequently generated through the action of water (double strand breaks, loss of a nucleotide base, and deamidation of cytosine), UV radiation (thymine dimers and strand breaks), or exposure to chemical modifiers (adduct formation). This multilayered system is composed of mismatch repair enzymes, nucleotide excision repair enzymes, and base excision repair enzymes as well as the Ku system for repairing double-strand breaks in the phosphodiester backbone (see Chapter 35). As a last resort, cells harboring damaging mutations are subject to removal by apoptosis.

Nevertheless, despite the many precautions taken to insure fidelity during replication and to repair subsequent damage listed above, some mutations inevitably slip through. Indeed, some leakage in the surveillance and repair system is necessary in order to generate the genetic variability that enables evolution.

The **somatic mutation theory of aging** proposes that it also serves as a driver of the aging process. Simply put, the accumulation of mutant cells over time must inevitably lead to compromised biological function that manifests itself, at least in part, as the physical changes we associate with aging.

Some Types of Protein Damage Can Be Repaired

In contrast to DNA, a cell's capacity to repair damage to other biomolecules is relatively limited. For the most part, cells appear to rely on routine turnover, wherein the global population of a given biomolecule is degraded and replaced by new synthesis on a continuing, or constitutive, basis (see Chapter 9) to remove aberrant lipids, carbohydrates, and proteins. Some proteins, particularly the fibrous proteins that contribute to the structural integrity of tendons, ligaments, bones, matrix, etc., undergo little if any turnover. These long-lived proteins tend to accumulate damage over many years, contributing to the loss of elasticity in vascular tissues and joints, loss of lens opacity, etc. The most prominent mechanisms for the repair of damaged proteins target the side chain sulfur atoms of cysteine and methionine, and the isoaspartyl groups formed when a peptide bond shifts from an alpha- to a side-chain carboxyl group.

The side-chain sulfhydryl group of cysteine frequently plays important catalytic, regulatory, and structural roles in

proteins that are dependent upon its oxidation state. However, both its sulfhydryl group and the sulfur ether of methionine are extremely vulnerable to oxidation (Figure 58–3C). As is the case for many other oxidized biomolecules, the tripeptide glutathione can react directly with cysteine-disulfides, cysteine sulfenic acids, and methioninesulfoxide to regenerate cysteine and methionine, respectively. In addition, disulfide reductases and methionine sulfoxide reductases provide an enzyme-catalyzed reduction mechanism using NADPH as electron donor. Unfortunately, the reduction potential of glutathione and NADPH is only sufficient to reduce the lowest oxidation states of these sulfur atoms: cysteine disulfides or sulfenic acids and methionine sulf-oxide. Cysteine sulfinic acid, cysteine sulfonic acid, and methioninesulfone are refractory to reduction under physiologic conditions.

Aspartic acid residues possess the precise geometry needed to enable the side-chain carboxyl group to react with the amino group within the peptide bond formed with its alpha carboxyl group. The resulting cyclic diamide can then reopen to form either the original peptide bond or an isoaspartyl residue in which the side-chain carboxyl now forms part of the protein's peptide backbone (Figure 58–6). Methylation of the alpha carboxyl group provides a leaving group that promotes the reformation of the cyclic diamide, which can then reopen to form the normal peptide bond linkage (Figure 58–6).

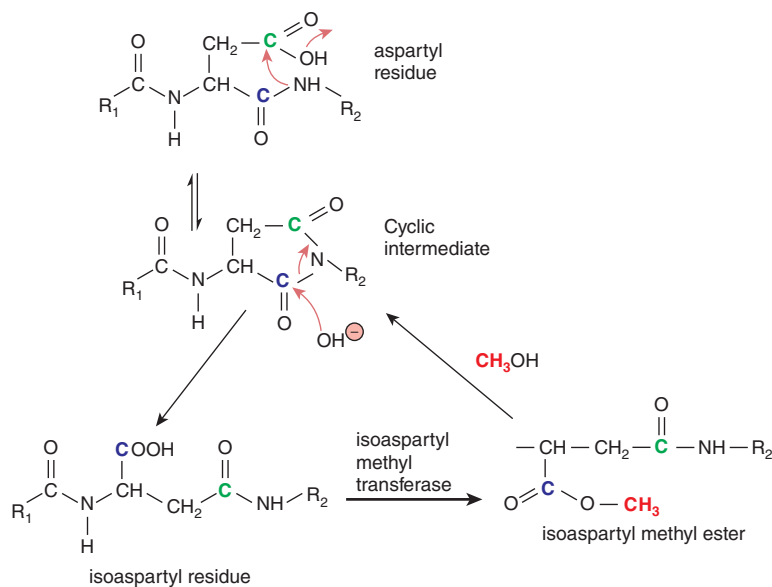

FIGURE 58–6 Formation of an isoaspartyl linkage in a polypeptide backbone and its repair via the intervention of isoaspartyl methyltransferase. Shown is the sequence of chemical and enzyme-catalyzed reactions that lead to formation of an isoaspartyl linkage and restoration of a normal peptide linkage. The carbons corresponding to the alpha and side-chain carboxylic acid groups in aspartic acid are colored blue and green, respectively. Red arrows denote the routes of nucleophilic attack during the cyclization and hydrolysis reactions. The methyl group added by isoaspartyl methyltransferase is colored pink.

Aggregated Proteins Are Highly Refractory to Degradation or Repair

Modifications to a protein's composition or conformation that cause it to adhere to other protein molecules can lead to the formation of toxic aggregates, called **amyloid**. Such aggregates form the hallmark of several neurodegenerative diseases, including Parkinson's, Alzheimer's, Huntington's disease, spinocerebellar ataxias, and the transmissible spongiform encephalopathies. The toxic effects of these insoluble aggregates are exacerbated by their persistence, as in this state most are generally refractory to the catalytic action of the proteases normally responsible for their turnover.

AGING AS A PREPROGRAMMED PROCESS

While molecular wear and tear undoubtedly contribute to aging, several observations suggest a role for programmed, deterministic mechanisms as well. For example, rather than "rusting" gradually, many of the physical manifestations of aging—liver spots, grayness, trembling hands, memory lapses—generally surface late in adulthood and progress at a rapid pace, as if the molecular maintenance mechanisms responsible for their repair and replacement had suddenly received a command to cease operation. Female menopause provides an unambiguous example of an age-associated physiological change that is genetically programmed and hormonally controlled. The paragraphs below describe several current theories regarding deterministic, programmed mechanisms for controlling aging and death.

Metabolic Theories of Aging: "The Brighter the Candle, the Quicker It Burns"

One of the many variants of the famous quote attributed to the ancient Chinese philosopher Lao Tzu summarizes the salient features of **metabolic theories of aging**. Its origins can be traced to the observation that the larger members of the animal kingdom tend to live longer than the smaller ones (Table 58–4). Reasoning that the causal basis for this correlation lay in something connected with size, rather than size itself, many scientists focused their attention on the organ most frequently associated with life and vitality—the heart. In general, the resting heart rate of small animals such as hummingbirds, 250 beats per minute, tends to be higher than those of large animals such as whales, 10 to 30 beats per minute. Estimates of the cumulative number of times each vertebrate animal's heart beat over the course of a lifetime exhibited an amazing convergence on 1.0×10^9 beats: one billion.

The so-called **heartbeat hypothesis** posited that every living creature is capable of performing only a finite number of heartbeats and/or breaths. A more nuanced variation of this basic idea, variously referred to as the **metabolic** or **rate of living hypothesis**, was put forward by Raymond Pearl in the 1920s. Pearl proposed that an individual's lifespan was

TABLE 58–4 Lifespan Versus Body Mass for Several Mammals

Species	Approximate Mass (kg)	Mean Expectation of Life at Maturity (years)
White-footed mouse	0.02	0.28
Deer mouse	0.02	0.43
Bank vole	0.025	0.48
Eastern chipmunk	0.1	1.63
American pika	0.13	2.33
Golden mantled grd. squirrel	0.155	2.12
Red squirrel	0.189	2.45
Belding's ground squirrel	0.25	1.78
Uinta ground squirrel	0.35	1.72
Eastern gray squirrel	0.6	2.17
Arctic ground squirrel	0.7	1.71
Eastern cottontail	1.25	1.48
Striped skunk	2.25	1.90
American badger	7.15	2.33
North American river otter	7.2	3.79
Bobcat	7.5	2.48
North American beaver	18	1.52
Impala	44	4.80
Bighorn sheep	55	5.48
Wild boar	85	1.91
Warthog	87	2.82
Nilgiri tahr	100	4.71
Blue wildebeest	165	4.79
Red deer stag	175	4.90
Waterbuck	200	5.87
Burchell's zebra	270	7.95
African buffalo	490	4.82
Hippopotamus	2390	16.40
African elephant	4000	19.10

Source: Adapted from Millar JS, Zammuto: Life histories of mammals: an analysis of life tables. Ecology 1983;64:631.

reciprocally linked to their basal metabolic rate. In other words, those who "burned the candle at both ends," so to speak, burnt out sooner. A new round of calculations revealed that, while animals differ markedly in size, longevity, and heart rate; over their lifetime each expends a similar amount of total metabolic energy *per unit body mass*, 7×10^5 J/g. While intuitively

appealing, identification of a mechanistic link between lifespan and energy expenditure or metabolic rate has proven elusive. Adherents of the mitochondrial theory of aging suggest that what is being “counted” is not heartbeats or energy, but the ROS that are the by-product of respiration. Over time the continued generation of energy and related consumption of O₂ leads to the accumulation of ROS-induced damage to DNA, proteins, and lipids until, eventually, a universally conserved tipping point is reached. Cells experiencing caloric deficits adjust (reprogram) their metabolic pathways to utilize available resources in a more efficient manner that concomitantly decreases the yield of collateral ROS.

Telomeres: A Molecular Countdown Clock?

A second school of thought holds that the putative countdown clock that controls aging and lifespan does not sense heartbeats, energy, or ROS. Rather, it uses **telomeres** to track the number of times each somatic cell divides.

Telomeres are composed of long strings of GT-rich hexanucleotide repeats that cap the ends of eukaryotic chromosomes. Unlike the closed circular DNA of bacterial genomes, the genomic DNA of eukaryotes is linear. If left unprotected, the exposed ends of these linear polynucleotides would be available to participate in potentially deleterious genetic recombination events. A second function of telomeres is to provide some disposable DNA to accommodate the wastage that occurs when linear DNA molecules are replicated.

This wastage is a consequence of the fact that all DNA polymerases work unidirectionally, 3' to 5' (see Chapter 35). While in closed circular DNA this is not a problem, when trying to replicate the 5' ends of a linear double stranded DNA via discontinuous 3' to 5' synthesis and ligation of small **Okazaki** fragments, there is simply not enough room at the end to accommodate the small RNA primer, polymerase, etc. Synthesis of the 5' end of each strand will generally fall 100 bp or more short. Each time a cell divides, its chromosomes will be shortened further (Figure 58–7). The telomeres provide an innocuous source of DNA whose decreasing length is of little immediate consequence to the cell. However, once the supply of telomere DNA is exhausted, roughly 100 cell divisions for humans, mitosis ceases and the somatic cell enters a state of **replicative senescence**. As more and more cells within the body enter senescence, it progressively loses the capacity to replace lost or damaged cells.

Organisms are able to generate progeny that contain full-length telomeres thanks to the intervention of the enzyme **telomerase**. Telomerase is a ribonucleoprotein that is expressed in stem cells and most cancer cells, but not in somatic cells. Using an RNA template, telomerase adds GT-rich hexanucleotide repeat sequences ranging from a few hundred (yeast) to several thousand (humans) nucleotides in length to the ends of linear DNA molecules to restore their telomeres to full length. When somatic cells are genetically engineered in the laboratory to express telomerase, they continue to divide in culture long after an unaltered control cell line stops. The ability to prevent replicative senescence using an enzyme that maintains

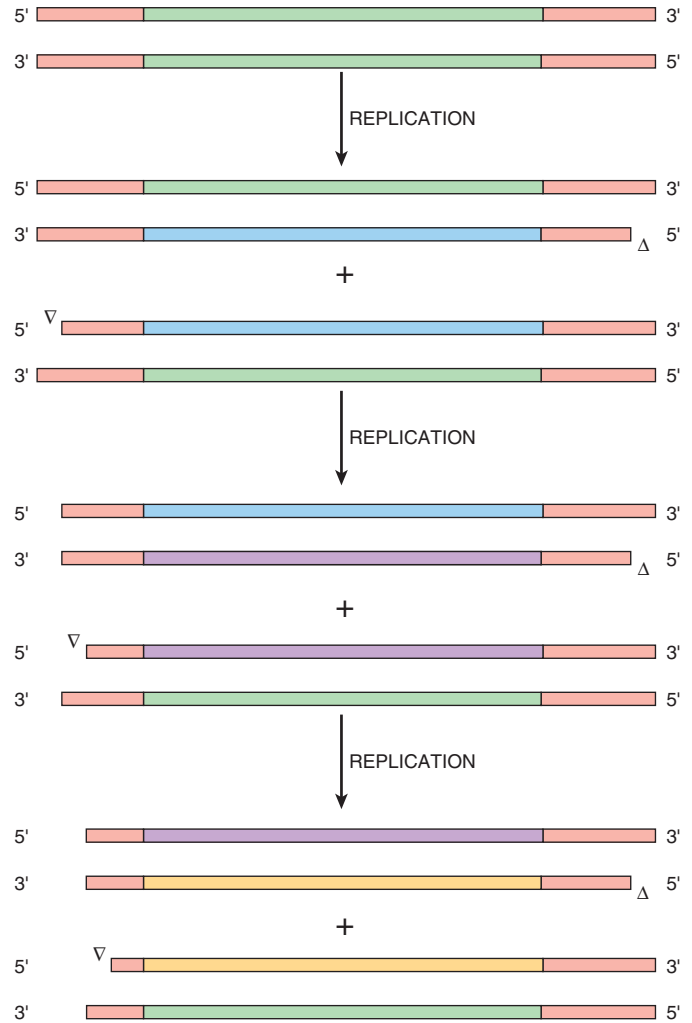

FIGURE 58–7 The telomeres at the ends of eukaryotic chromosomes progressively shorten with each cycle of replication. Shown is a schematic diagram of the linear DNA of a eukaryotic chromosome (green) containing telomeres at each end (red). During the first replication, new DNA strands are synthesized (green) using the original chromosome as template. For simplicity, the next two replication cycles (purple, yellow) show the fate of only the lower of the two nucleotide products from the preceding replicative cycle. Open arrowheads denote the site of incomplete strand synthesis. The model assumes that the single strand overhangs at the ends of each chromosome are trimmed at the completion of each cycle of cell division. Note the progressive shortening of the telomere repeats.

telomeres at full-length represents the most compelling evidence of the operation of a telomere clock.

Kenyon Used a Model Organism to Discover the First Aging Genes

Many advances in biomedical science are the product of research that uses a variety of so-called model organisms as their test subject. The fruit fly, *Drosophila melanogaster*, has yielded a rich harvest of information concerning the genes that guide cellular differentiation and organ development. Baker's yeast and the African clawed frog, *Xenopus laevis*, have

served as the workhorses for dissecting the complex signal transduction circuitry that orchestrates the cell division cycle. A variety of cultured mammalian cell lines serve as surrogates for adipocytes, kidney cells, tumors, dendrites, etc. While at first glance it would appear that many of these model systems share little in common with humans, each possesses unique attributes that render them convenient vehicles for addressing certain problems and exploring specific systems.

Caenorhabditis elegans is a worm that has served as an important subject for the study of developmental biology. *C. elegans* is transparent and grows rapidly, attributes which facilitated tracing the entire developmental program for all 959 cells found in the mature adult back to the fertilized egg. In the early 1990s, Cynthia Kenyon and colleagues observed that worms carrying mutations of the gene encoding an insulin receptor-like molecule, *daf-2*, lived 70% longer than their wild-type counterparts. Equally important, the mutant worms behaved in a manner resembling that of young wild-type *C. elegans* for much of this period. This is an important distinction. To qualify as an “aging gene,” its manipulation must accomplish more than merely delaying the point at which life ceases. It must impact the schedule of changes associated with aging.

Investigation of further aging genes indicate they code for either one of a small set of transcription factors that include PHA-4 or DAF-16, which presumably control expression of aging critical genes, or signaling proteins such as DAF-2 that probably activate PHA-4, DAF-16, etc, in response to specific environmental signals. Much remains to be learned about the extent to which aging is controlled by genetically programmed events, and how these gene and their products interact with nutritional and other factors that influence vitality and longevity.

WHY WOULD EVOLUTION SELECT FOR LIMITED LIFESPANS?

The idea that animals would have evolved mechanisms designed specifically to limit their lifespan would appear, at first glance, to be highly counterintuitive. If the driving force behind evolution is the selection for traits that enhance fitness and survival, should not this translate into an ever-increasing life expectancy? While maximizing lifespan may represent a desirable trait from the point of view of the individual, it does not necessarily follow that this applies to a population or species as a whole. A genetically programmed limit on lifespan could benefit the group by eliminating the drain on available resources imposed by members no longer actively involved in the production, development, and training of offspring. Indeed, the current three generation lifespan can be rationalized as providing time (a) for newborns to develop into reproductively active young adults, (b) for these young adults to produce and nurture their offspring, and (c) to serve as a source of guidance and assistance to young adults facing the challenges of childbirth and childrearing.

SUMMARY

- Aging and longevity are controlled via the complex and largely cryptic interplay between random and deterministic factors that include genetic programming, environmental stresses, lifestyle, cellular countdown clocks, and molecular repair processes.
- Wear and tear theories of aging hypothesize that the changes associated with old age and death itself reflect the accumulation of damage over time.
- The ubiquitous and life-essential environmental elements water, oxygen, and light possess an intrinsic capacity to damage biological macromolecules.
- ROS such as hydroxyl radical and superoxide are particularly problematic as they are highly reactive, often participating in chain reactions that multiply their impact, and are continually generated as a byproduct of the complex network of redox reactions taking place in the electron transport chain.
- The reactivity of their unsaturated ring systems and ability to absorb UV light render the nucleotide bases of DNA particularly vulnerable to UV or chemical damage.
- Mutations resulting from errors caused by missing or chemically modified nucleotide bases can be particularly harmful, as they may result in oncogenic transformation or render a cell vulnerable to further damage.
- Mitochondria occupy a central place in many theories of aging and death. This prominence can be attributed to several factors. Mitochondria are the site of the electron transport chain, by far the largest source of ROS in the cell.
- The efficient production of ATP is essential to cell vitality. Mitochondria play a central role in apoptosis, programmed cell death. Mitochondria lack the capacity to repair damage to their DNA.
- In eukaryotic cells, long repeating sequences called telomeres cap the ends of their linear chromosomes. These telomeres progressively shorten each time a somatic cell divides. When a somatic cell's telomeres become too short, it enters replicative senescence. Thus, telomeres are hypothesized to serve as a countdown clock for somatic cells.
- Animal lifespan may be genetically programmed. Mutation of the *daf-2* gene in *Caenorhabditis elegans* yielded worms whose lifespan was 70% longer than wild type.
- Evolutionary selection of a limited lifespan may optimize the vitality of the population rather than that of its individual members.

REFERENCES

- Aguzzi A, O'Connor T: Protein aggregation diseases: pathogenicity and therapeutic perspectives. *Nat Drug Discov* 2010;9:237.
- Anderson S, Bankier AT, Barrell BG, et al: Sequence and organization of the human mitochondrial genome. *Nature* 1981;290:457.
- Arias E, Curtin LR, Wei R, et al: U.S. decennial life tables for 1999–2001, United States life tables. *Natl Vital Stat Rep* 2008;57:1.
- Baraibar MA, Friguet B: Oxidative proteome modifications target specific cellular pathways during oxidative stress, cellular senescence and aging. *Exp Gerontol* 2013;48:620.

- Clarke S: Aging as war between chemical and biochemical processes: protein methylation and the recognition of age-damaged proteins for repair. *Ageing Res Rev* 2003;2:263.
- Eisenberg DTA: An evolutionary overview of human telomere biology: the thrifty telomere hypothesis and notes on potential adaptive paternal effects. *Am J Hum Biol* 2011;23:149.
- Kenyon CJ: The genetics of aging. *Nature* 2010;464:504.
- Lopez-Otin C, Blasco MA, Partridge L, et al: The hallmarks of aging. *Cell* 2013;153:1194.
- Martin-Molvano A, de Cabo R: Mitochondrial metabolic reprogramming induced by calorie restriction. *Antioxid Redox Signal* 2013;19:310.
- Nakamura T, Cho DH, Lipton SA: Redox regulation of protein misfolding, mitochondrial dysfunction, synaptic damage, and cell death in neurodegenerative diseases. *ExpNeurol* 2012;238:12.
- Newgard CB, Sharpless NE: Coming of age: molecular drivers of aging and therapeutic opportunities. *J Clin Invest* 2013;23:946.
- Speakman JR: Body size, energy metabolism and lifespan. *J ExpBiol* 2005;208:1717.
- Ulrich P, Cerami A: Protein glycation, diabetes, and aging. *Recent ProgHorm Res* 2001;56:1.
- Wang CH, Wu SB, Wu YT, Wei YH: Oxidative stress responses elicited by mitochondrial dysfunction: implication in the pathophysiology of aging. *Exp Biol Med* 2013;238:450.

Exam Questions

Section XI – Special Topics (C)

- Which one of the following statements regarding the blood coagulation pathways is NOT CORRECT?
 - The components of the extrinsic Xase (tenase) complex are factor VIIa, tissue factor, Ca^{2+} , and factor X.
 - The components of the intrinsic Xase (tenase) complex are factor IXa, factor VIIIa, Ca^{2+} , and factor X.
 - The components of the prothrombinase complex are factor Xa, factor Va, Ca^{2+} , and factor II (prothrombin).
 - The extrinsic and intrinsic Xase complexes and prothrombinase complex require anionic procoagulant phosphatidylserine on LDL (low-density lipoprotein) for their assembly.
 - Fibrin formed by cleavage of fibrinogen by thrombin is covalently cross-linked by the action of factor XIIIa, which itself is formed by the action of thrombin on factor XIII.
- On which one of the following coagulation factors does a patient taking warfarin for his thrombotic disorder have decreased Gla (γ -carboxyglutamate) residues?
 - Tissue factor
 - Factor XI
 - Factor V
 - Factor II (prothrombin)
 - Fibrinogen
- A 65-year-old man suffers a myocardial infarction and is given tissue plasminogen activator within 6 hours of onset of the thrombosis to achieve which one of the following?
 - Prevent activation of the extrinsic pathway of coagulation
 - Inhibit thrombin
 - Enhance degradation of factors VIIIa and Va
 - Enhance fibrinolysis
 - Inhibit platelet aggregation
- Which one of the following statements regarding platelet activation in hemostasis and thrombosis is NOT CORRECT?
 - Platelets adhere directly to subendothelial collagen via GPIa-IIa and GPVI, while binding of GPIb-IX-V is mediated via von Willebrand factor.
 - The aggregating agent thromboxane A_2 is formed from arachidonic acid liberated from platelet membrane phospholipids by the action of phospholipase A_2 .
 - The aggregating agent ADP is released from the dense granules of activated platelets.
 - The aggregating agent thrombin activates intracellular phospholipase $\text{C}\beta$, which forms the internal effector molecules 1,2-diacylglycerol and 1,4,5-inositol trisphosphate from the membrane phospholipid phosphatidylinositol 4,5-bisphosphate.
 - The ADP receptors, the thromboxane A_2 receptor, the thrombin PAR-1 and PAR-4 receptors, and the fibrinogen GPIIb-IIIa receptor are all examples of G protein-coupled receptors.
- A 15-year-old girl presented at clinic with bruises on her lower extremities. Of the following, which is *least likely* to explain the bleeding signs exhibited by this individual?
 - Hemophilia A
 - von Willebrand disease
 - A low platelet count
 - Aspirin ingestion
 - A platelet disorder with absence of storage granules
- Regarding chemical carcinogenesis, select the one FALSE statement:
 - Approximately 80% of human cancers may be due to environmental factors.
 - In general, chemical carcinogens interact noncovalently with DNA.
 - Some chemicals are converted to carcinogens by enzymes, usually cytochrome P450 species.
 - Most ultimate carcinogens are electrophiles and attack nucleophilic groups in DNA.
 - The Ames assay is a useful test for screening chemicals for mutagenicity; however, animal testing is required to show that a chemical is carcinogenic.
- Regarding viral carcinogenesis, select the one FALSE statement:
 - Approximately 15% of human cancers may be caused by viruses.
 - Only RNA viruses are known to be carcinogens.
 - RNA viruses causing or associated with tumors include hepatitis C virus.
 - Retroviruses possess reverse transcriptase, which copies RNA to DNA.
 - Tumor viruses act by deregulating the cell cycle, inhibiting apoptosis, and interfering with normal cell signaling processes.
- Regarding oncogenes and tumor suppressor genes, select the one FALSE statement:
 - Both copies of a tumor suppressor gene must be mutated for its product to lose its activity.
 - Mutation of an oncogene occurs in somatic cells and is not inherited.
 - The product of an oncogene shows a gain of function that signals cell division.
 - RB* and *P53* are tumor suppressor genes; *MYC* and *RAS* are oncogenes.
 - Mutation of one tumor suppressor gene or one oncogene is thought to be sufficient to cause cancer.
- Regarding growth factors, select the one FALSE statement:
 - They include a large number of polypeptides, most of which stimulate cell growth.
 - Growth factors can act in an endocrine, paracrine, or autocrine manner.
 - Certain growth factors, such as TGF- β , can act in a growth inhibitory manner.
 - Some receptors for growth factors have tyrosine kinase activity; mutations of these receptors occur in cancer cells.
 - PDGF stimulates phospholipase A_2 , which hydrolyzes PIP_2 to form DAG and IP_3 , both of which are second messengers.

10. Regarding the cell cycle, select the one FALSE statement:
- Cells transiting the cell cycle can reside within any of the five phases of the cell cycle (ie, G_1 , G_0 , S, G_2 , and M).
 - Cancer cells usually have a shorter generation time than normal cells and there are fewer of them in G_0 phase.
 - A variety of mutations in cyclins and CDKs have been reported in cancer cells.
 - RB is a cell cycle regulator, where it binds to transcription factor E2F, thus allowing progression of the cell from G_1 to S phase.
 - When damage to DNA occurs, p53 increases in amount and activates transcription of genes that delay transit through the cycle.
11. Regarding chromosomes and genomic instability, select the one FALSE statement:
- Cancer cells may have a mutator phenotype, which means that they have mutations in genes that affect DNA replication and repair, chromosomal segregation, DNA damage surveillance, and apoptosis.
 - Chromosomal instability refers to gain or loss of chromosomes caused by abnormalities of chromosomal segregation during mitosis.
 - Microsatellite instability involves expansion or contraction of microsatellites due to abnormalities of nucleotide excision repair.
 - Aneuploidy (when the chromosomal number of a cell is not a multiple of the haploid number) is a common feature of tumor cells.
 - Abnormalities of chromosome cohesion and of kinetochore-microtubule attachment may contribute to chromosomal instability and aneuploidy.
12. Select the one FALSE statement:
- The activity of telomerase is frequently elevated in cancer cells.
 - A number of cancers have a strong hereditary predisposition or susceptibility: these include Li-Fraumeni syndrome and retinoblastoma.
 - The products of *BRCA1* and *BRCA2* (responsible for hereditary breast cancer types I and II) appear to be involved in DNA repair.
 - Tumor cells usually exhibit a high rate of anaerobic glycolysis; this may be at least partly explained by the presence in many tumor cells of the PK-2 isozyme, which is associated with lesser production of ATP and possibly increased use of metabolites to build up biomass.
 - Dichloroacetate, a compound found to display some anticancer activity, inhibits pyruvate carboxylase, and thus diverts pyruvate away from glycolysis.
13. Select the one FALSE statement:
- Whole-genome and Exome sequencing is revealing important new information about the numbers and types of mutations in cancer cells.
 - Abnormalities of epigenetic mechanisms, such as demethylation of cytosine residues, abnormal modification of histones, and aberrant chromatin remodeling are being increasingly detected in cancer cells.
 - Persistence of cancer stem cells (which are often relatively dormant and have active DNA repair systems) may help to explain some of the shortcomings of chemotherapy.
 - Angiogenin is an inhibitor of angiogenesis.
 - Chronic inflammation, possibly via increased production of reactive oxygen species, predisposes to development of certain types of cancer.
14. Regarding apoptosis, select the one FALSE statement:
- Apoptosis can be initiated by the interaction of certain ligands with specific receptors on cell surface.
 - Cell stress and other factors activate the mitochondrial pathway of apoptosis; release of cytochrome P450 into the cytoplasm is an important event in this pathway.
 - A distinct pattern of fragments of DNA is found in apoptotic cells; it is caused by caspase-activated DNase.
 - Caspase 3 digests cell proteins such as lamin, certain cytoskeletal proteins, and various enzymes, leading to cell death.
 - Cancer cells have acquired various mutations that allow them to evade apoptosis, prolonging their existence.
15. Select the one FALSE statement:
- Proteins involved in cell adhesion include cadherins, integrins, and selectins.
 - Decreased amounts of E-cadherin on the surfaces of cancer cells may help account for the decreased adhesiveness shown by tumor cells.
 - Increased activity of GlcNAc transferase V in cancer cells may lead to an altered glycan lattice at the cell surface, perhaps predisposing to their spread.
 - Cancer cells secrete metalloproteinases that degrade proteins in the ECM and facilitate their spread.
 - All tumor cells have the genetic capacity to colonize.
16. The number of enzymes dedicated to repairing hydrolytic, oxidative, and photochemical damage to polynucleotides such as DNA is much greater than the number devoted to repairing damaged proteins. Identify the statement from the list below that is INCONSISTENT with this observation:
- Polynucleotides absorb ultraviolet light more efficiently than do proteins.
 - Proteins contain sulfur, an element that is susceptible to oxidation.
 - In general, proteins turn over more frequently than does DNA.
 - Mutations in a structural gene have the potential to alter the proteins they encode as well as the DNA itself.
 - If left uncorrected, genome mutations will be passed on to succeeding generations.
17. Which of the following is NOT a feature of the mitochondrial hypothesis of aging?
- Reactive oxygen species are generated as a byproduct by the electron transport chain.
 - Mitochondria lack the capacity to repair damaged DNA.
 - Many of the complexes in the electron transport chain are constructed from a mixture nuclearly encoded and mitochondrially encoded subunits.
 - Damaged mitochondria form protease-resistant aggregates.
 - Damaged mitochondria can trigger apoptosis—programmed cell death.

18. Which of the following is NOT a component of the cell's suite of damage repair and prevention agents?
- A. Superoxide dismutase
 - B. Glutathione
 - C. Isoaspartyl methyltransferase
 - D. Catalase
 - E. Caspase 7
19. Select the one of the following statements that describes an aspect of the metabolic theory of aging:
- A. Elevated levels of plasma glucose promote the formation of cross-linked protein aggregates.
 - B. Damage from ROS is multiplied by the tendency of oxygen radicals to multiply via chain reactions.
 - C. Calorically restricted diets promote lower and more efficient metabolic activity.
 - D. Blood flow to the heart muscle becomes restricted over time due to the cholesterol-induced formation of arterial plaques.
 - E. Vigorous physical activity correlates with the loss of STEM cells.
20. Select the one of the following statements that is NOT CORRECT:
- A. Telomeres prevent genetic recombination by capping the ends of linear DNA molecules.
 - B. Aging genes can be distinguished by their impact on an organism's lifespan.
 - C. The short lifespan of *Caenorhabditis elegans* renders them an attractive model organism for studying aging.
 - D. Telomere shortening is a consequence of the discontinuous nature of the process by which the "lagging strand" is synthesized during chromosome replication.
 - E. Telomerase activity is high in both STEM cells and in many cancer cells.

The Answer Bank

Section I – Proteins: Structure & Function

1. Long before recorded history most civilizations knew that sugars could be converted to alcoholic beverages. The ability of scientists prior to the 20th century to discover the intermediates in this process was, however, hindered by the contention of the great Louis Pasteur that fermentation could take place only in intact cells. The fortuitous discovery by the Büchners that a cell-free yeast extract stored in a concentrated sugar solution produced ethanol and carbon dioxide enabled biochemists and physicians to identify the intermediates, enzymes, and cofactors involved in fermentation and the closely related process of glycolysis.
2. It was soon discovered that fermentation ceased after a certain time, despite the presence of ample sugars as substrate. Only when inorganic orthophosphate was added did fermentation resume. This observation led rapidly to the isolation and characterization of each intermediate of fermentation and glycolysis. Apart from the starting sugar and the end products, ethanol or pyruvate, these intermediates all are phosphate esters. Similar experiments using heated extracts of yeast facilitated the discovery of ATP, ADP, and the cofactor NAD.
3. Preparations used throughout the 20th century to identify and study the metabolites and enzymes of biochemical processes include, in decreasing order of complexity, perfused intact livers, slices of liver tissue, crude homogenates, the particulate and soluble portions of homogenates separated by high-speed centrifugation, and both crude and purified enzyme preparations.
4. The availability of radioactive isotopes of carbon, hydrogen, and phosphorus (^{14}C , ^3H , and ^{32}P) greatly simplified the ability to detect and isolate the intermediates of metabolic processes such as cholesterol biosynthesis, nucleotide biosynthesis, and the pathways by which individual amino acids are degraded.
5. Garrod proposed that alkaptonuria, albinism, cystinuria, and pentosuria were consequences of altered metabolism, and termed these conditions “inborn errors of metabolism”—a term we would today call “genetic disorders of metabolism.” Garrod’s insights provided a foundation for the developing field of biochemical genetics described in later chapters of this text.
6. The regulation of cholesterol biosynthesis illustrates the linkage between biochemistry and genetics. Cell surface receptors internalize circulating plasma cholesterol, which then regulates cholesterol biosynthesis. As discussed in later chapters, individuals with truncated or otherwise defective receptors fail to internalize cholesterol, and consequently suffer from extreme hypercholesterolemia.
7. The most important model organisms include yeast (eg. *Saccharomyces cerevisiae*), slime mold (*Dictyostelium discoideum*), the fruit fly (*Drosophila melanogaster*), and the small round worm *Caenorhabditis elegans*. The advantages of these model organisms include facile growth and manipulation, short generation times, and the ability to generate informative mutants.
8. **D.** Hydrocarbons are water-insoluble.
9. **A.** Phenylalanine, tyrosine, and tryptophan are the only protein amino acids that absorb light at 280 nm.
10. **D.** Since at its pK_a a weak acid bears no *net* charge, its mobility would be essentially zero in a buffer whose pH was equal to pK_a .
11. **C.** The important distinction here is between “charge” and “*net* charge.” At its pI a typical amino acid contains an equal number of positive and negative charges, and thus is charged, but has no *net* overall charge.
12. **C.** During sequencing of a protein the Edman technique involves successive derivatization and removal of successive *N*-terminal residues.
13. Molecules that are nonpolar tend to self-associate in an aqueous environment. A large droplet minimizes the surface area in contact with water. Since water molecules at a lipid interface have fewer possibilities of hydrogen bonding (ie, have reduced degrees of freedom), a large droplet maximizes number of water molecules free to optimize their hydrogen bonding interactions, a situation that is thermodynamically favored.
14. The distinction is based on how completely a base dissociates in solution. A strong base is essentially completely dissociated in solution. For example, sodium hydroxide exists in solution as sodium ions and hydroxide ions. By contrast, a weak base such as barium hydroxide dissociates only partially in solution. Most remains as $\text{Ba}(\text{OH})_2$. Similar considerations distinguish strong and weak acids.
15. **E.** Complex mixtures of peptides can be separated by tandem mass spectrometry without their prior purification.
16. **E.** Many proteins undergo posttranslational processing. An early example is insulin, which is synthesized as a single polypeptide which subsequent proteolysis converts to two polypeptide chains linked by disulfide bonds.
17. pI is the pH at which a molecule bears no *net* charge. In this example the pI is a pH midway between the 3rd and 4th pK_a values: $\text{pI} = (6.3 + 7.7)/2 = 7.0$. To confirm this conclusion, imagine how the net charge on the molecule will change as the solution is adjusted from strongly acidic to strongly basic pH. As the carboxylate groups and subsequently the ammonium groups begin to ionize, the net charge will change successively as follows: +3, +2, +1, 0, -1, -2, -3.
18. All of the protein amino acids are *essential* since protein synthesis cannot occur unless all are present. Some amino acids must, however, be present in the diet of a given organism. These “nutritionally essential” amino acids (10 for humans) are those which an organism cannot synthesize from amphibolic intermediates. While many vitamins might be termed “dietarily essential,” this differs between organisms. For example, vitamin C is *dietarily essential* only for humans, catfish, and certain other organisms.
19. **D.** Gene arrays, also termed DNA chips or DNA arrays, contain multiple DNA probes with differing sequences bound at known locations on a solid glass, silicone, or nylon support. Hybridization of complementary DNA or RNA probes at particular locations provides information about their nucleic acid composition.
20. **D.** A hydrogen bond interaction involves the residue in fourth place along the helix.

21. **E.** Unlike viruses, which contain either DNA or RNA encapsulated within a protein coat, prions contain no nucleic acid and consist exclusively of protein. Prion diseases are transmitted by the protein alone without involvement of DNA or RNA.
22. Unlike the second dissociating group of phosphoric acid ($pK_2 = 6.82$), the other two dissociating groups of phosphoric acid cannot serve as effective buffers at physiologic pH because they are either completely dissociated or predominantly protonated at that pH.
23. **A:** Carboxyl groups (pK_1 through pK_3) and amino groups (pK_4 through pK_7)
B: Minus one
C: Plus 0.5
D: Toward the cathode
24. The pK of a dissociating group of an effective buffer should be no less than 0.5 pH units removed from the desired pH. The buffering compound must also be present in sufficient excess to buffer the predicted influx of acid or base.
25. Carboxylation of a glutamyl residue forms γ -carboxyglutamate, a potent chelator of Ca^{++} essential for blood clotting and clot dissolution. The hydroxylation of proline and of lysine forms 4-hydroxyproline and 5-hydroxylysine, important components of several structural proteins including collagen.
26. (a) Copper is an essential prosthetic group for amine oxidase, the enzyme responsible for converting lysine to hydroxylysine in collagen. Hydroxylation of lysine is essential for the formation of covalent crosslinks that help give collagen its exceptional strength.
 (b) Ascorbic acid is an essential cofactor for the enzyme proline hydroxylase, which converts proline to hydroxyproline in collagen. The hydroxyl group of hydroxyproline provides additional inter-chain hydrogen bonds that stabilize the collagen triple helix.
27. Signal sequences are used to target proteins to specific subcellular locations in the cell, or for secretion from the cell.
3. **B.** When the reactants are present in concentrations of 1.0 mol/L, ΔG^0 is the standard free-energy change. For biochemical reaction, the pH (7.0) is also defined and this is ΔG^0 .
4. **D.** ATP contains two high-energy phosphate bonds and is needed to drive endergonic reactions. It is not stored in the body and in the presence of uncouplers its synthesis is blocked.
5. **A.** Reduced cytochrome c is oxidized by cytochrome c oxidase (complex IV of the respiratory chain), with the concomitant reduction of molecular oxygen to two molecules of water.
6. **E.** Cytochrome oxidase is not a dehydrogenase, although all other cytochromes are classed as such.
7. **B.** Although Cytochromes p450 are located mainly in the endoplasmic reticulum, they are found in mitochondria in some tissues.
8. **D.** Oxidation of one molecule of NADH via the respiratory chain generates 2.5 molecules of ATP in total. One is formed via complex I, 1 via complex II and 0.5 via complex IV.
9. **C.** 1.5 molecules of ATP are formed in total as $FADH_2$ is oxidized, 1 via complex II and 0.5 via complex IV.
10. **E.** Oligomycin blocks oxidation and ATP synthesis as it prevents the flow of electrons back into the mitochondrial matrix through ATP synthase.
11. **A.** Uncouplers allow electrons to reenter the mitochondrial matrix without passing through ATP synthase.
12. **E.** In the presence of an uncoupler, the energy release as electron flow into the mitochondrial matrix is not captured as ATP and is dissipated as heat.
13. **C.** Thermogenin is a physiological uncoupler found in brown adipose tissue. Its function is to generate body heat.
14. **D.** Three ATP molecules are generated for each revolution of the ATP synthase molecule.
15. **B.** The electrochemical potential difference across the inner mitochondrial membrane caused by electron transport must be negative on the matrix side so that protons are forced to reenter via the ATP synthase to discharge the gradient.

Section II – Enzymes, Kinetics, Mechanism, Regulation, & Bioinformatics

1. Carbonic anhydrase catalyzes the hydration of carbon dioxide to form carbonic acid. A portion of this weak acid, in turn, dissociates to produce bicarbonate and a proton. As the concentration of carbon dioxide falls, carbonic acid is broken down from carbon dioxide and water. To compensate for the loss of carbonic acid, bicarbonate and protons recombine to restore equilibrium, leading to a net drop in $[H^+]$ and a rise in pH.
2. **D.** 3. **E.** 4. **B.** 5. **A.**
6. **E.** 7. **B.** 8. **C.** 9. **A.**
10. **D.** 11. **E.** 12. **B.** 13. **B.**
14. **C.** 15. **D.** 16. **B.** 17. **B.**
18. **C.**

Section III – Bioenergetics

1. **A.** A reaction with a negative ΔG is exergonic, it proceeds spontaneously and free energy is released.
2. **E.** In an exergonic reaction ΔG is negative and in an endergonic reaction it is positive. When ΔG is zero, the reaction is at equilibrium.

Section IV – Metabolism of Carbohydrates

- | | | | |
|---------------|---------------|---------------|---------------|
| 1. C. | 2. D. | 3. E. | 4. D. |
| 5. C. | 6. C. | 7. E. | 8. B. |
| 9. B. | 10. E. | 11. C. | 12. D. |
| 13. D. | 14. D. | 15. D. | 16. E. |
| 17. E. | 18. C. | 19. C. | 20. C. |
| 21. D. | 22. A. | 23. B. | 24. C. |
| 25. D. | 26. E. | 27. A. | 28. B. |

Section V – Metabolism of Lipids

1. **D.**
2. **D.**
3. **A.** Gangliosides are derived from glucosylceramide.
4. **C.** A, B, D, and E are classed as preventive antioxidants as they act by reducing the rate of chain initiation.
5. **D.**
6. **B.**
7. **D.** Long chain fatty acids are activated by coupling to CoA, but fatty acyl CoA cannot cross the inner mitochondrial membrane. After transfer of the acyl group from CoA to carnitine by carnitine palmitoyl transferase (CPT)-I, acylcarnitine is

- carried across by carnitine-acylcarnitine translocase in exchange for a carnitine. Inside the matrix, CPT-II transfers the acyl group back to CoA and carnitine is taken back into the intermembrane space by the translocase enzyme.
8. E. The breakdown of palmitic acid (C16) requires 7 cycles of β -oxidation each producing 1 FADH₂ and 1 NADH molecule and results in the formation of eight 2C acetyl CoA molecules.
 9. B. When the action of carnitine palmitoyl transferase-I is inhibited by malonyl CoA, fatty acyl groups are unable to enter the matrix of the mitochondria where their breakdown by β -oxidation takes place.
 10. C. Humans (and most mammals) do not possess enzymes able to introduce a double bond into fatty acids beyond $\Delta 9$.
 11. D. Inhibition of the tricarboxylic acid transporter causes levels of citrate in the cytosol to decrease and favors inactivation of the enzyme.
 12. A.
 13. C.
 14. E.
 15. E. Glucagon is released when blood glucose levels are low. In this situation, fatty acids are broken down for energy and fatty acid synthesis is inhibited.
 16. E. Glucagon, ACTH, epinephrine and vasopressin promote activation of the enzyme.
 17. B.
 18. D.
 19. A. Chylomicrons are triacylglycerol-rich lipoproteins synthesized in the intestinal mucosa using fat from the diet and secreted into lymph.
 20. E. VLDL is synthesized and secreted by the liver, and adipose tissue and muscle take up the fatty acids released by the action of lipoprotein lipase.
 21. D. Very low density lipoprotein secreted by the liver is converted to intermediate density lipoprotein and then to low density lipoprotein (LDL) by the action of lipases and the transfer of cholesterol and proteins from high density lipoprotein. LDL delivers cholesterol to extrahepatic tissues and is also cleared by the liver.
 22. A. Chylomicrons are synthesized in the intestine and secreted into lymph after a fat meal.
 23. E. Chylomicrons and their remnants are cleared from the circulation rapidly after a meal, and the secretion of very low density lipoprotein by the liver then increases. Ketone bodies and nonesterified fatty acids are elevated in the fasting state.
 24. C. When cholesteryl ester is transferred from HDL to other lipoproteins by the action of CETP it is ultimately delivered to the liver in VLDL, IDL, or LDL.
 25. D. Chylomicrons are metabolized by lipoprotein lipase when bound to the surface of endothelial cells. This process releases fatty acids from triacylglycerol which are then taken up by the tissues. The resulting smaller, cholesterol-enriched chylomicron remnant particles are released into the circulation and cleared by the liver.
 26. C. Cholesterol is synthesized in the endoplasmic reticulum from acetyl CoA. The rate-limiting step is the formation of mevalonate from 3-hydroxy 3-methylglutaryl-CoA by HMG CoA reductase and lanosterol is the first cyclic intermediate.
 27. C.
 28. C. Secondary bile acids are produced by the modification of primary bile acids in the intestine.
 29. B. If the LDL receptor is defective, LDL is not cleared from the blood, causing severe hypercholesterolemia.
 30. A. PCSK9 regulates the re-cycling of LDL receptors to the cell surface after endocytosis has taken place. Inhibition of PCSK9 activity, therefore, increases the number of LDL receptor molecules on the cell surface, leading to an increased rate of clearance and lower blood cholesterol levels.

Section VI – Metabolism of Proteins & Amino Acids

1. D. Phenylalanine hydroxylase catalyzes a functionally irreversible reaction, and thus cannot convert tyrosine to phenylalanine.
2. E. Histamine is a catabolite, not a precursor, of histidine.
3. B. The insertion of selenocysteine into a peptide occurs during, not subsequent to translation.
4. C. Pyridoxal-dependent transamination is the first reaction in degradation of all the common amino acids except threonine, lysine, proline, and hydroxyproline.
5. B. Glutamine.
6. C. The carbon skeleton of alanine contributes the most to hepatic gluconeogenesis.
7. B. ATP and ubiquitin participate in the degradation of nonmembrane-associated proteins and proteins with *short* half-lives.
8. C. Due to the failure to incorporate NH₄⁺ into urea, clinical signs of metabolic disorders of the urea cycle include *alkalosis*, not acidosis.
9. E. *Cytosolic* fumarase and *cytosolic* malate dehydrogenase convert fumarate to oxaloacetate following a *cytosolic* reaction of the urea cycle. The *mitochondrial* fumarase and malate dehydrogenase function in the TCA cycle, not urea biosynthesis.
10. A. Serine, not threonine, provides the thioethanol moiety of coenzyme A.
11. E. Decarboxylation of *glutamate*, not *glutamine* forms GABA.
12. 5-Hydroxylysine and γ -carboxyglutamate represent examples of posttranslational modification of peptidyl lysyl and peptidyl glutamyl residues, respectively. By contrast, selenocysteine is incorporated into proteins cotranslationally, in the same way as the other 20 common protein amino acids. The process is complex, and involves the unusual tRNA termed tRNA^{sec}.
13. Biosynthesis of the amino acids that are dietarily essential for humans requires multiple reactions. Since human diets typically contain adequate amounts of these amino acids, loss of the genes that can encode these “unnecessary” enzymes and the lack of need to expend the energy required to copy them provide an evolutionary advantage.
14. Since glutamate dehydrogenase plays multiple central roles in metabolism, its complete absence would unquestionably be fatal.
15. E. Albumin is not a hemoprotein. In cases of hemolytic anemia, albumin can bind some metheme, but unlike the other proteins listed, albumin is not a hemoprotein.
16. A. Acute intermittent porphyria is due to mutations in the gene for uroporphyrin I synthase.
17. A. Bilirubin is a *linear* tetrapyrrole.
18. D. The severe jaundice, upper abdominal pain, and weight loss plus the lab results indicating an obstructive type of jaundice are consistent with cancer of the pancreas.

19. The assay takes advantage of the different water solubility of unconjugated and conjugated bilirubin. Two assays are conducted, one in the absence and a second in the presence of an organic solvent, typically methanol. The highly polar glucuronic acid groups of conjugated bilirubin convey water solubility that insures that it will react with the colorimetric reagent even in the absence of any added organic solvent. Data from an assay conducted in the *absence* of added methanol, termed “direct bilirubin,” is bilirubin glucuronide. A second assay conducted in the *presence* of added methanol measures *total* bilirubin, ie, both conjugated and unconjugated bilirubin. The *difference* between total bilirubin and direct bilirubin, reported as “indirect bilirubin,” is *unconjugated* bilirubin.
20. The biosynthesis of heme from succinyl-CoA and glycine occurs only when the availability of free iron signals the potential for synthesis of heme. Regulation targets the first enzyme of the pathway, δ -aminolevulinic synthase (ALA synthase) rather than a subsequent reaction. This conserves energy by avoiding wasting a coenzyme A thioester.

Section VII – Structure, Function, & Replication of Macromolecules

- D. β,γ -Methylene and β,γ -imino purine and pyrimidine triphosphates do not readily release the terminal phosphate by hydrolysis or by phosphoryl group transfer.
 - D.
 - E. Pseudouridine is excreted unchanged in human urine. Its presence there is not indicative of pathology.
 - A. Metabolic disorders are infrequently associated with defects in pyrimidine catabolism, which forms water-soluble products.
- | | | | |
|--------|--------|--------|--------|
| 5. B. | 6. D. | 7. B. | 8. C. |
| 9. C. | 10. D. | 11. E. | 12. B. |
| 13. D. | 14. D. | 15. E. | 16. A. |
| 17. C. | 18. B. | 19. D. | 20. B. |
| 21. C. | 22. A. | 23. C. | 24. A. |
| 25. E. | 26. B. | 27. A. | 28. E. |
| 29. C. | 30. A. | 31. A. | 32. C. |
| 33. D. | 34. E. | 35. C. | 36. B. |
| 37. C. | 38. E. | 39. D. | 40. D. |
| 41. B. | 42. A. | 43. A. | 44. E. |
| 45. C. | 46. A. | 47. C. | 48. D. |
| 49. C. | 50. B. | 51. E. | 52. C. |
| 53. D. | 54. A. | 55. E. | 56. A. |
| 57. E. | 58. C. | 59. A. | 60. D. |
| 61. D. | 62. E. | 63. A. | 64. C. |
| 65. C. | 66. E. | 67. D. | |

Section VIII – Biochemistry of Extracellular & Intracellular Communication

- B. Glycolipids are located on the outer leaflet.
 - A. Alpha-helices are major constituents of membrane proteins.
 - E. Insulin also increases glucose uptake in muscle.
 - A. Its action maintains the high intracellular concentration of potassium compared with sodium.
- | | | | |
|-------|--------|--------|--------|
| 5. D. | 6. B. | 7. C. | 8. B. |
| 9. D. | 10. A. | 11. E. | 12. B. |

- | | | | |
|--------|--------|--------|--------|
| 13. D. | 14. E. | 15. B. | 16. C. |
| 17. A. | 18. C. | 19. A. | 20. B. |
| 21. D. | 22. A. | | |

Section IX – Special Topics (A)

- | | | | |
|--------|--------|--------|--------|
| 1. A. | 2. E. | 3. C. | 4. D. |
| 5. E. | 6. D. | 7. C. | 8. B. |
| 9. D. | 10. E. | 11. C. | 12. B. |
| 13. C. | 14. D. | 15. B. | 16. A. |
| 17. B. | 18. C. | 19. E. | 20. D. |
| 21. E. | 22. A. | 23. C. | 24. C. |
| 25. A. | 26. E. | 27. A. | 28. A. |
| 29. A. | 30. C. | 31. E. | 32. A. |
| 33. B. | 34. A. | 35. B. | 36. C. |
| 37. D. | 38. E. | 39. E. | 40. A. |
| 41. D. | 42. C. | 43. B. | 44. E. |
| 45. C. | 46. B. | 47. B. | 48. B. |
| 49. B. | 50. C. | 51. D. | 52. C. |
| 53. A. | 54. A. | 55. A. | 56. E. |
| 57. A. | | | |

Section X – Special Topics (B)

- Within the body, hydrolysis of nitroglycerin releases nitrate ions that can be reduced by mitochondrial aldehyde dehydrogenase to generate nitric oxide (NO), a potent vasodilator.
 - The contractile cycle of cardiac muscle is controlled by oscillations in the level of cytosolic Ca^{2+} . If the reuptake of Ca^{2+} by the sarcoplasmic reticulum is slowed sufficiently by a deficiency SERCA2a activity, cardiac myocytes will be unable to clear this second messenger from their cytoplasm prior to the onset of the next cycle of excitation. The persistence of high basal levels of cytosolic Ca^{2+} will lead to both a reduction in the amplitude of the contractile cycle and the progressive uncoupling of the excitation-contraction cycle.
 - Similarities include both forms of myosin light chain kinase are activated by Ca^{2+} -calmodulin and both enzymes phosphorylate the regulatory light chain (light chain 2) in the head group of myosin. The key difference is that phosphorylation of myosin light chains is an obligate step for the initiation of contraction in smooth muscle, whereas this role is fulfilled by the troponin system striated muscle.
- | | | | |
|-------|-------|-------|-------|
| 4. A. | 5. D. | 6. B. | 7. E. |
|-------|-------|-------|-------|
- D.
 - As the major protein, by mass, in the blood, albumin serves as the primary contributor to the maintenance of the osmotic pressure. Since albumin is synthesized primarily in hepatocytes, the maintenance of the osmotic pressure of blood can be compromised if disease or damage to the liver impairs its capacity to synthesize albumin. If osmotic pressure falls sufficiently, the Starling forces that normally drive the net flow of water from the tissues into the blood will be dissipated, leading to the accumulation of fluid in the tissues.
 - Haptoglobin binds extracorporeal hemoglobin, forming a complex that is too large to pass through the glomerulus into kidney tubules.
 - The production of new antibodies with unique antigen binding properties is reliant upon the recombination and mutation of the DNA encoding the hypervariable regions

of the immunoglobulin heavy and light chains. Cytidine deaminase introduces genetic mutations by catalyzing the hydrolysis of cytosine bases present in DNA to uracil.

12. **B.** 13. **C.** 14. **C.** 15. **B.**
 16. **E.** 17. **E.**
 18. Erythrocytes deficient in glucose-6-phosphate are rendered extremely vulnerable to destruction by reactive oxygen species resulting from a lack of reduced glutathione, an important agent for protecting against oxidative stress. This is a consequence of their reliance on this enzyme to generate a plentiful supply of the NADPH used by glutathione reductase.
 19. **E.** 20. **C.** 21. **D.** 22. **A.**
 23. **C.** 24. **D.** 25. **B.** 26. **A.**
 27. **E.** Importins are involved in the import of proteins into the nucleus.
 28. **B.** Some mammalian proteins are known to be translocated post-translationally.
 29. **C.** Ubiquitin tags proteins for degradation by proteasomes.
 30. **E.** Furin converts proalbumin to albumin.
 31. **C.** NSF is an ATPase
 32. **D.** Cross-links are an important feature of collagen structure.
 33. **C.** Deletions in the elastin gene have been identified as responsible for many cases of Williams–Beuren syndrome.
 34. **B.** Ehlers–Danlos syndrome subtypes kyphoscoliosis and dermatosparaxis are caused by defects in noncollagen genes.
 35. **B.** Hyaluronic acid (hyaluronan) is not sulfated.
 36. **C.** Hurler syndrome is caused by a deficiency of α -L-iduronidase.
 37. **D.** Achondroplasia is caused by mutations in the FGFR3 gene.

Section XI - Special Topics (C)

1. **D.**
2. **D.** Of the listed proteins, only factor II is a vitamin K-dependent coagulation factor.
3. **D.**
4. **E.** GPIIb-IIIa (integrin α IIb β 3) is not a G protein-coupled receptor.
5. **A.** Hemophilia A, being an X-chromosome-linked disease, is very unlikely to occur in a female.
6. **B.** Most chemical carcinogens interact covalently with DNA.
7. **B.** Certain DNA viruses are also known to be carcinogenic.
8. **E.** Mutations in approximately 5 to 6 of these two types of cancer promoting or suppressor genes are thought to be necessary for carcinogenesis.
9. **E.** PDGF stimulates phospholipase C, not phospholipase A.
10. **D.** Binding of RB to E2F blocks progression of the cell from G₁ to S phase.
11. **C.** Microsatellite instability is caused by abnormalities of mismatch repair.
12. **E.** Dichloroacetate inhibits pyruvate dehydrogenase kinase.
13. **D.** Angiogenin is an inhibitor of angiogenesis.
14. **B.** Cytochrome C is released from mitochondria.
15. **E.** Only about 1 in 10,000 cancer may have the capacity to colonize.
16. **B.** 17. **D.** 18. **D.** 19. **C.**
 20. **B.**

This page intentionally left blank

Index

Note: Page numbers followed by *f* indicate figures; and page numbers followed by *t* indicate tables.

- A**
 α -adrenergic receptors, in glycogenolysis, 180
 α -amino acids. *See also* Amino acids
 genetic code specifying, 16, 16*t*–17*t*
 in proteins, 15, 16*t*–17*t*
L- α -Amino adipate, 306*f*
L- α -Amino adipate-D-semialdehyde, 306*f*
 α -Aminobutyrate metabolism, 320, 321*f*
 α -Amino nitrogen. *See* Amino acid nitrogen
 α_1 -Antiproteinase
 in emphysema and liver disease, 679
 inhibitor, 706
 α_1 -Antitrypsin, 706, 717
AAV. *See* Adenovirus-associated virus
A band, 648
ABC-1. *See* ATP-binding cassette transporter-1
Abetalipoproteinemia, 256–257, 275*t*
A blood group substances, 697–698, 697*f*
ABO system
 ABO substances and, 696–698
 importance in blood transfusion, 697
Absorption, 537–544
Absorption spectra, of porphyrins, 327, 329*f*
Absorptive pinocytosis, 493
ACAT. *See* Acyl-CoA:cholesterol acyltransferase
ACAT (acyl-CoA:cholesterol acyltransferase), 271
Accelerator (Ac-) globulin (factor V), 713*t*
Acceptor arm of tRNA, 366, 366*f*, 416, 416*f*
Acceptor (A/aminoacyl) site, aminoacyl-tRNA
 binding to, 422, 423*f*
Accuracy, laboratory (lab) tests, 591, 591*f*
Aceruloplasminemia, 675
ACEs. *See* Angiotensin-converting enzyme
 inhibitors
Acetic acid, 213*t*
 p*K*/p*K*_a value of, 13*t*
Acetoacetate, 226, 227*f*
 in tyrosine catabolism, 305*f*
Acetoacetyl-CoA synthetase, in mevalonate
 synthesis, 267, 267*f*
Acetone, 226
2-Acetylaminofluorene structure, 725*f*
Acetylation, 586–587
 in covalent modification, 31*t*
 of histones, 735
 in regulation of enzymatic catalysis, 94
Acetylcholine, inhibiting release of, 623
Acetyl-CoA carboxylase, 233
 in lipogenesis regulation, 234*f*, 237, 237*f*
N-acetylglactosamine linkage to serine, 573*f*
N-acetylglutamate, in urea biosynthesis, 293*f*, 295
N-acetyllactosamine units, 575
Acetyl (acyl)-malonyl enzyme, 233, 234*f*
acetyl-CoA, 140, 140*f*, 145
 carbohydrate metabolism and, 140, 140*f*
 catabolism of, 162*f*, 163*f*. *See also* Citric acid
 cycle
 cholesterol synthesis and, 267–270, 267*f*, 269*f*
 fatty acid oxidation to, 140, 141*f*, 224*f*
 lipogenesis and, 233, 234*f*, 235*f*
 as fatty acid building block, 233
 in lipogenesis regulation, 237
 in platelet-activating factor synthesis, 248*f*
 pyruvate dehydrogenase regulation by, 173,
 174*f*, 237
 pyruvate oxidation to, 165, 166*f*, 169*t*, 172–174,
 173*f*, 174*f*
N-acetylneuraminic acid, 159*f*, 159*t*, 204*f*, 574
 in gangliosides, 250, 251*f*
 in glycoproteins, 203, 204*f*, 571*t*
Acetyl transacylase, 233, 233*f*, 234*f*
Acetyltransferases, 587
Acholuric jaundice, 332
Achondroplasia, 496*t*, 645*f*
Acid anhydride bonds, 340
Acid anhydrides, group transfer potential for,
 343
Acid-base balance, 292
Acid-base catalysis, 63
Acidemia, isovaleric, 300*t*, 309
Acidic phosphoproteins, 642
Acidosis
 lactic. *See* Lactic acidosis
 metabolic, ammonia in, 292
Acid phosphatase, diagnostic significance of, 68
Acids, 13*t*
 conjugate, 11
 molecular structure affecting strength of, 13
 polyfunctional, nucleotides as, 342
 as proton donors, 10
 strong, 10
 weak. *See* Weak acids
Aciduria
 dicarboxylic, 231
 methylmalonic, 187
 orotic, 356–357
 urocanic, 299, 300*t*
Aconitase (aconitate hydratase), 162
ACP. *See* Acyl carrier protein
Acromicral dysplasia, 632
Acrosomal reaction, 579
ACTH. *See* Adrenocorticotropic hormone
Actin, 648, 695*t*, 696
 decoration of, 651, 651*f*
 F-Actin, 650, 651
 G-Actin, 649
 in muscle contraction, 651–655, 654
 regulation of striated muscle and, 653
Actin filaments, 664–665
Actin (thin) filaments, 622, 648, 649*f*
Activated protein C, in blood coagulation, 717
Activated protein C resistance, 717
Activating enzyme, in ubiquitinylation, 620
Activation energy, 74–75
Activation energy barrier, enzymes affecting, 77
Activation-induced cytidine deaminase, 684
Activators. *See also* Enhancers/enhancer elements
 in regulation of gene expression, 429
Active chromatin, 373–374, 374*f*, 437
Active site, 62–63, 63*f*. *See also* Catalytic site
Active sulfate (adenosine 3'-phosphate-5'-
 phosphosulfate), 343*f*, 344
Active transport, 331*f*, 485, 485*f*, 485*t*, 486, 486*f*,
 486*t*
 in bilirubin secretion, 331
Actomyosin, 650
Acute coronary syndrome, 698
Acute fatty liver of pregnancy, 231
Acute inflammation, biomolecules with vasoactive
 properties involved in, 703*t*
Acute inflammatory response, 700
Acute pancreatitis, 599
Acute phase proteins, 544, 671, 672*t*
 negative, vitamin A as, 546, 551
A cyclins, 388*f*, 388*t*, 389
Acylcarnitine, 224, 224*f*
Acyl carrier protein, 233, 233*f*, 561
 synthesis of, from pantothenic acid, 233
Acyl-CoA:cholesterol acyltransferase, 271
Acyl-CoA dehydrogenase, 121, 224*f*, 225, 225*f*
 in fatty acid activation, 224*f*, 226
 medium-chain, deficiency of, 231
 in triacylglycerol synthesis, 248, 261, 262*f*
Acyl-CoA synthetase, 127
Acylglycerol, 246–250
Acylglycerol metabolism, 245–252
 catabolism, 246–250
 clinical aspects of, 250–251
 synthesis, 246–250, 246*f*
 in endoplasmic reticulum, 144*f*, 145
Adapter proteins, in absorptive pinocytosis, 493
Adaptive immune system, 685, 706
Additional proteins in muscle, 655, 655*t*
Adducts, 758
Adenine, 341*t*, 342*f*
Adenine nucleotide transporter, 132*f*, 134
Adenosine, 341*t*
 base pairing in DNA, 360, 361*f*
 syn and *anti* conformers of, 341*f*
 in uric acid formation, 354, 355*f*
Adenosine deaminase deficiency, 355
Adenosine monophosphate. *See* AMP
Adenosine 3'-phosphate-5'-phosphosulfate, 343*f*,
 344
Adenosine triphosphate. *See* ATP

- Adenovirus-associated virus, 455
- Adenylyl cyclase, 521–522, 521*t*
 cAMP derived from, 179
 in lipolysis, 263, 263*f*
- Adenylyl kinase (myokinase), 117, 127
 in gluconeogenesis regulation, 189
 as source of ATP in muscle, 662
- Adherens junctions, 484
- Adipocytes, 263
 turnover, 757*t*
- Adipose tissue, 140, 212, 261, 262*f*, 663
 ADP, 341*f*
 brown, 264, 264*f*
 in fasting state, 148, 149
 free energy of catabolism capture by, 132
 glucose uptake into, 148
 metabolism in, 147*f*, 150*t*, 261, 262*f*
- ADP, 116*f*
- ADPase, 720, 721*t*
- ADP-chaperone complex, 609. *See also*
 Chaperones
- ADP-ribose, NAD as source of, 556
- ADP-ribosylation, 556
- Adrenal function tests, 599
- Adrenal steroidogenesis, 502–505
 androgen synthesis, 504*f*, 505
 glucocorticoid synthesis, 504–505, 504*f*
 mineralocorticoid synthesis, 503, 504*f*
 pathways involved in, 504*f*
- Adrenergic receptors, in glycogenolysis, 180
- Adrenocorticotropic hormone and
 hypercortisolism, 599
- Adrenoleukodystrophy, neonatal, 614, 614*t*
- Advanced glycation endproducts, 578–579,
 761–762
 formation of, 578–579, 578*f*–579*f*
- Aerobic conditions, 662
 muscle generates ATP, 662
- Aerobic glycolysis, 172
 as muscle ATP source, 662
 rate in cancer cells, 739
- Aerobic respiration and citric acid cycle, 161–162
- α -fetoprotein, 672*t*
 as tumor biomarker, 739*t*
- Affect differentiation, anti-cancer drugs, 740*t*
- Affect epigenetic changes, anti-cancer drugs, 740*t*
- Affinity chromatography
 for protein/peptide purification, 28
 in recombinant fusion protein purification, 70
- Affinity of SRP-R, for SRP, 616
- AFP. *See* α -fetoprotein
- Agammaglobulinemia, 687
- A gene, 697–698
- AGEs. *See* Advanced glycation endproducts
- Aggrecan, 643
- Aggregated proteins, toxic effects of, 764
- Aggregates, formation of, 45
- Aggregation prevention, 616
- Aging
 metabolic theories of, 764–765
 and mortality, 756
 as preprogrammed process, 764–766
 somatic mutation theory of, 763
 wear and tear theories of, 756–762
 free radicals, 760
 hydrolytic reactions, 756–758, 757*f*
 mitochondria, 760–761
 protein glycation, 761–762, 762*f*
 reactive oxygen species, 758–760, 758*f*, 759*f*
 ultraviolet radiation, 761, 761*f*
- Aging genes
 model organisms to discover, 765–766
 transcription factors, 766
- α -hemolysin, 490
- AHG. *See* Antihemophilic factor A/globulin
- 7 α -Hydroxylase, sterol, 273
- α -ketoglutarate, 299
 in amino acid carbon skeleton catabolism,
 298*f*
 dehydrogenase complex, 163
- A kinase anchoring proteins, 523
- ALA. *See* Aminolevulinate
- Alactasia, 599
- Alanine, 16*t*, 289, 314
 α -Alanine, 301
 β -Alanine, 318
 in pyruvate formation, 301
 synthesis of, 283, 283*f*
- Alanine aminotransferase, 69, 598*t*
 diagnostic significance of, 68*t*
 and jaundice, 598
 in urea synthesis, 291, 291*f*
- Alanine transaminase. *See* Alanine
 aminotransferase
- ALAS1 (hepatic ALA synthase), 326–327
 in porphyria, 328*t*, 330
- ALA synthase, 326–327
- Albumin, 623, 634, 668, 669, 671
 conjugated bilirubin binding to, 333
 copper binding to, 675
 free fatty acids in combination with, 223, 254*t*,
 255, 671
- Albumin:globulin ratio (A:G ratio), 598
- Albuminuria, 634
- Alcohol dehydrogenase in fatty liver, 261
- Alcohol, ethyl. *See* Ethanol
- Alcoholism
 case study, 747
 cirrhosis and, 261
 fatty liver and, 261
 transferrin glycosylation in, 674
- Aldehyde dehydrogenase, 120
 in fatty liver, 261
- Aldolases
 aldolase A deficiency, 174
 aldolase B, 202, 202*f*
 deficiency of, 205
 in glycolysis, 170, 170*f*
- Aldose reductase, 202, 202*f*, 205
- Aldoses, 152, 153*t*, 154, 155*f*
 ring structure of, 153*f*
- Alimentary pentosuria, 205
- α -linolenic acid, 214
 for essential fatty acid deficiency, 239
- α -lipoproteins. *See also* High-density lipoproteins
 familial deficiency of, 275*t*
- Alkaline phosphatase, 642
 isozymes of, diagnostic significance of, 68*t*
- Alkalosis, ammonia in, 292
- Alkaptonuria, 304
- Allergic reactions, peptide absorption causing,
 537
- Allopurinol, 344, 344*f*, 354, 356–357
- Allosteric activators, 188
- Allosteric effectors/modifiers, 26*f*, 145
 in gluconeogenesis regulation, 188–189
 negative, 90. *See also* Feedback inhibition in
 allosteric regulation
 second messengers as, 91–92
- Allosteric enzymes, 90–91, 145
 aspartate transcarbamoylase as model of, 91
- Allosteric properties of hemoglobin, 54
- Allosteric regulation, of enzymatic catalysis,
 90–91, 90*f*, 146*f*
 gluconeogenesis regulation and, 188–189
- Allosteric site, 91
- All-trans-retinoic acid, 740*t*
- ALP. *See* Alkaline phosphatase
- Alpha anomers, 154
- Alpha helix, 38–39, 38*f*
- Alport syndrome, 631
- ALT. *See* Alanine aminotransferase
- Alteplase. *See* Tissue plasminogen activator
- Alternative pathway, 686
- Altitude, adaptation to high, 57
- Alu family, 377, 380
- Alzheimer disease, 46
- α_2 -Macroglobulin, 679–680, 706, 717
- Amadori products, 761
- Amadori rearrangement, 578
- Ambiguity and genetic code, 414
- Ames assay, 725*f*
- Amino acid carbon skeletons
 catabolism of. *See* Amino acid carbon skeletons,
 catabolism of
 fate of, 298*t*
- Amino acid carbon skeletons, catabolism of, 298
 acetyl-CoA formation and, 303*f*, 305*f*, 310*f*,
 311*f*
 branched-chain, 308–309, 310*f*
 disorders of, 309–311
 pyruvate formation and, 299*f*, 301, 303*f*
 transamination in initiation of, 298–299,
 298*f*
- Amino acid metabolism, metabolic diseases of,
 300*t*
- Amino acid nitrogen
 in amino acid carbon skeleton catabolism,
 298–299, 298*f*, 299*f*, 301*f*
 catabolism of, 287–296
 end products of, 290
 urea as, 292–293, 293*f*
- L-Amino acid oxidase, 120
- L-glutamate dehydrogenase in, 291, 292*f*
 in nitrogen metabolism, 291, 291*f*
 transamination of, 290–291, 290*f*, 291*f*
- Amino acids, 3, 15–24, 16*t*–17*t*, 291*f*. *See also*
 Peptides
 absorption of, 539, 541
 ammonia removal from, 291–294, 291*f*
 analysis/identification of, 23–24
 biosynthesis, 283
 blood glucose and, 190
 branched chain, catabolism of, 308–309, 310*f*
 disorders of, 309–311
 catabolism intermediates for carbohydrate and
 lipid biosynthesis, 298
 in catalysis, conservation of, 66, 66*t*
 in citric acid cycle, 146
 deamination of. *See* Deamination
 deficiency of, 281, 544

- excitatory. *See* Aspartate; Glutamate
 extraterrestrial, 18–19
 functional group properties, 20–22
 glucogenic, 146
 in gluconeogenesis, 164, 165*f*
 hydrolysis of peptide bonds, 756–757
 interconvertibility of, 146
 interorgan exchange maintaining circulating levels of, 289–290
 keto acid replacement of in diet, 285
 ketogenic, 146
 metabolism of, 140*f*, 141, 141*f*. *See also* Amino acid carbon skeletons; Amino acid nitrogen
 pyridoxal phosphate in, 557
 net charge of, 20, 20*f*
 nonprotein, 19*t*
 nutritionally essential, 141, 282, 282*t*
 nutritionally nonessential, 141, 282, 282*t*
 synthesis of, 282–286
 in peptides, 15, 22, 23*f*
 pK/pK_a values of, 16*t*–17*t*, 20, 20*f*
 environment affecting, 21
 post-translational modifications of, 16, 18, 18*f*
 potentially toxic, 19–20, 19*t*
 products derived from, 313–321. *See also*
 specific product
 properties of, 16–20
 protein degradation and, 288–289, 288*f*
 in proteins, 16*t*–17*t*
 requirements for, 543–544
 sequence in primary structure, 22
 solubility point of, 21–22, 22*f*
 stereochemistry, 18, 18*f*
 substitutions, missense mutations caused by, 417, 417*f*
 synthesis, 282–286, 282*t*
 in carbohydrate metabolism, 140
 citric acid cycle in, 164, 165*f*
 transamination of. *See* Transamination
 transporter/carrier systems, hormones affecting, 487
 unusual, 22–23, 23*f*
 Amino acid sequences. *See also* Protein sequencing
 primary structure determined by, 22
 Aminoacyl residues, 22
 peptide structure and, 22
 Aminoacyl (A/acceptor) site, aminoacyl-tRNA
 binding to, 422, 423*f*
 Aminoacyl-tRNA in protein synthesis, 422
 Aminoacyl-tRNA synthetases, 415, 415*f*
 Aminolevulinate, 325, 325*f*
 in porphyria, 329
 Aminolevulinate dehydratase, 325, 325*f*
 in porphyria, 328*t*, 329
 Aminolevulinate synthase, 325–327, 325*f*, 326–327
 in porphyria, 328*f*, 328*t*, 329
 Aminopeptidases, 539
 Aminophospholipids, membrane asymmetry and, 482
 Amino sugars (hexosamines), 156, 156*f*
 glucose as precursor of, 203, 204*f*
 in glycosaminoglycans, 156, 203, 204*f*
 in glycosphingolipids, 203, 204*f*
 interrelationships in metabolism of, 204*f*
 Aminotransferases, 165, 165*f*, 283
 diagnostic significance of, 68*t*
 in urea biosynthesis, 291, 291*f*
 Ammonia
 in acid-base balance, 292
 detoxification of, 292
 glutamine synthase fixing, 292, 292*f*
 nitrogen removed as, 291–294, 292*f*
 Ammonia intoxication, 291–292
 Ammonium ion, pK/pK_a value of, 13*t*
 Amobarbital and oxidative phosphorylation, 127
 AMP, 116*f*, 341*f*, 341*t*, 342*f*
 coenzyme derivatives of, 344*t*
 cyclic. *See* Cyclic AMP
 feedback regulation of, 350–351, 351*f*
 free energy of hydrolysis of, 115
 IMP conversion to, 348, 350*f*
 PRPP glutamyl amidotransferase regulated by, 350
 structure of, 342*f*
 Amphibolic pathways/processes, 139
 citric acid cycle and, 164
 Amphipathic helices, 39
 Amphipathic lipids, 220–221, 221*f*
 in lipoproteins, 254–255, 255*f*
 in membranes, 220–221, 221*f*, 479–480, 479*f*
 Amphipathic molecules and folding, 8
 Ampicillin, 455
 Ampicillin (Amp) resistance genes, 455
 Amylases, 60–61
 in hydrolysis of starch, 538
 Amyloidosis, 680
 Amyloid precursor proteins in Alzheimer disease, 46
 Amylopectin, 156, 158*f*, 538
 Amylopectinosis, 179*t*
 Amylose, 156, 158*f*
 Anabolic pathways/anabolism, 114, 139. *See also*
 Endergonic reaction; Metabolism
 Anaerobic conditions, 662
 Anaerobic glycolysis, 168, 169*f*, 170*f*, 663
 as muscle ATP source, 663
 Analbuminemia, 671
 Anaphylaxis, slow-reacting substance of, 242
 Anaplerotic reactions, in citric acid cycle, 164
 Anchor, 623
 Andersen disease, 179*t*
 Androgens, peripheral aromatization of, 505
 Androgen synthesis, 504*f*, 505
 Anemias, 58
 causes of, 689, 693*t*
 definition, 689
 hemolytic, 168, 174
 deficiency causing, 196, 204–205
 haptoglobin levels in, 673
 hyperbilirubinemia/jaundice in, 334, 334*t*
 peroxidase and, 200, 200*f*
 iron deficiency, 541, 560, 677–679, 679*t*
 megaloblastic
 folate deficiency causing, 560
 pernicious, 550*t*
 sickle cell. *See* Sickle cell disease
 vitamin B₁₂ deficiency causing, 559
 prevalence of, 689
 Aneuploidy, 731, 731*f*
 Angelman syndrome, 289
 Angiogenesis stimulation by cancer cells, 736
 Angiotensin-converting enzyme, 513
 Angiotensin-converting enzyme inhibitors, 513
 Angiotensin II
 biosynthesis, 513
 formation and metabolism of, 514*f*
 Angiotensinogen, 513
 Anion exchange protein (band 3), 695–696
 Ankyrin, 695*t*, 696
 Annotation, 102–103
 Anomeric carbon atom, 154
 Anserine, 315, 316*f*, 318
 Anterior pituitary gland hormones, blood glucose affected by, 192
 Anterograde transport (COPII), 621, 622*f*
 Anti-angiogenesis agents, 740*t*
 Anti-apoptotic genes, overexpression of, 734
 Antibiotics
 amino sugars in, 156
 bacterial protein synthesis affected by, 426
 folate inhibitors as, 559
 Antibodies, 668. *See also* Immunoglobulins
 monoclonal, hybridomas in production of, 684–685
 Antibody diversity, 684
 Anticancer agents, 739*t*
 Anti-cancer drugs
 side effects of, 741
 targets for, 741*f*
 Antichymotrypsin, 672*t*
 Anticoagulants (coumarin), 717
 Anticodon region of tRNA, 414–415, 416*f*
 Anti conformers, 341–342, 341*f*
 Antifolate drugs, purine nucleotide synthesis affected by, 348
 Antigenic determinant (epitope), 39
 Antihemophilic factor A/globulin, 714, 714*t*
 deficiency of, 718
 Antihemophilic factor B (factor IX)
 coumarin drugs affecting, 717
 deficiency of, 718
 Anti-hormonal agents, 740*t*
 Antimalarial drugs, folate inhibitors as, 559
 Antimicrobial (antithyroid peroxidase)
 antibodies, 599
 Antimycin A effect on respiratory chain, 132
 Antioxidant nutrients, 564–568
 Antioxidants, 125, 220
 retinoids and carotenoids as, 219, 546
 vitamin C as, 220
 vitamin E as, 125, 220, 553, 554*f*
 Antiparallel β sheet, 39, 39*f*
 Antiparallel loops, mRNA and tRNA, 416
 Antiparallel strands, DNA, 360, 361*f*
 Antiport systems, 486*f*, 487, 572
 Antiproteinase inhibitor, 706
 Antiproteinases, 706
 Antithrombin/antithrombin III, 668, 672*t*
 heparin binding to, 717
 Antithyroid peroxidase (antimicrobial)
 antibodies, 599
 Anti-TSH receptor antibodies, 599
 Aorta, 632
 APC. *See* Activated protein C
 Apical proteins, 623
 Apo A-I, 254*t*, 255, 274
 deficiencies of, 275*t*
 Apo A-II, 254*t*, 255
 lipoprotein lipase affected by, 257

- Apo A-IV, 254*t*, 255
 Apo B-48, 254*t*, 255
 Apo B-100, 254*t*, 255
 in LDL metabolism, 257*f*, 258
 regulation of, 271
 Apo B-100 receptor in LDL metabolism, 258
 Apo C-I, 254*t*, 255
 Apo C-II, 254*t*, 255
 in lipoprotein lipase activity, 257
 Apo C-III, 254*t*, 255
 lipoprotein lipase affected by, 257
 Apo D, 254*t*, 255
 Apo E, 254*t*, 255, 258
 Apo E receptor
 in chylomicron remnant uptake, 257*f*, 258
 in LDL metabolism, 258, 259, 260*f*
 Apolipoproteins/apoproteins, 255
 distribution of, 254*t*, 255
 hemoglobin, oxygenation affecting, 55
 Apomyoglobin, hindered environment for heme iron and, 53
 Apoproteins. *See* Apolipoproteins/apoproteins
 Apoptosis, 248, 250, 758
 cancer cells ways of evading, 734–735
 definition, 733
 microscopic features of, 733
 p53 and, 392
 phosphatidylcholines in, 216
 principal features of, 735*t*
 scheme of, 734*f*
 vs. necrosis, 733
 Apoptotic cell death program, 760
 Apo-transketolase activation, in thiamin nutritional status assessment, 556
 APP. *See* Amyloid precursor proteins
 Aquaporins, 490
 Arabinosylcytosine (cytarabine), 344, 345*f*
 Arachidonic acid/arachidonate, 215*f*, 238, 238*f*
 eicosanoid formation and, 239, 240*f*, 241*f*, 242*f*
 for essential fatty acid deficiency, 239
 Argentaffinoma (carcinoid), serotonin in, 316
 Arginase, 300*t*
 disorders of, 295–296, 295*t*
 in urea synthesis, 301*f*
 Arginine, 17*t*, 314
 catabolism of, 299, 301*f*
 metabolism of, 314*f*
 in urea synthesis, 299
 Argininosuccinate, in urea synthesis, 293*f*, 294
 Argininosuccinate lyase
 deficiency of, 295, 295*t*
 in urea synthesis, 293*f*, 294
 Argininosuccinate synthase, 295
 deficiency of, 295, 295*t*
 Argininosuccinicaciduria, 295
 Argonaute proteins, 409
 Aromatase enzyme complex, 505
 α -R groups, amino acid properties affected by, 22–23
 ARS. *See* Autonomously replicating sequences
 Arsenate, oxidation and phosphorylation affected by, 171
 Arsenite, oxidation and phosphorylation affected by, 174
 Arterial wall, 640
 Arthritis, gouty, 354
 Artificial membranes, 482–483
 Ascorbate, 200, 201*f*, 567, 568*t*
 Ascorbic acid (vitamin C), 196, 561–562, 561*f*
 as antioxidant, 220
 in collagen synthesis, 47, 562
 deficiency of, 562, 631
 collagen affected in, 47, 562
 Asialoglycoprotein receptors in cotranslational insertion, 615*f*, 616
 A (aminoacyl/acceptor) site, aminoacyl-tRNA binding to, 422, 423*f*
 α -SNAP, 623
 Asparaginase, in amino acid nitrogen catabolism, 292, 292*f*
 Asparagine, 17*t*
 in amino acid nitrogen catabolism, 298–299, 299*f*
 synthesis of, 283, 283*f*
 Asparagine synthetase, 283, 283*f*
 Aspartate, 165
 catabolism of, 298–299, 298*f*
 synthesis of, 283, 283*f*
 in urea synthesis, 294
 Aspartate 102, in covalent catalysis, 64–65
 Aspartate aminotransferase, 598, 598*t*
 diagnostic significance of, 68*t*, 69
 Aspartate transaminase. *See* Aspartate aminotransferase
 Aspartate transcarbamoylase, 91
 in pyrimidine synthesis, 353*f*, 354
 Aspartic acid, 17*t*
 Aspartic protease family, in acid-base catalysis, 64, 64*f*
 Aspirin
 antiplatelet actions of, 720–721
 cyclooxygenase affected by, 240
 prostaglandin synthesis affected by, 232
 Assembly particles, in absorptive pinocytosis, 493
 AST. *See* Aspartate aminotransferase
 Asthma, leukotrienes in, 213
 Asymmetric substitution, in porphyrins, 323, 324*f*
 Asymmetry
 importin binding and, 612
 inside-outside, 482
 lipid and protein, membrane assembly and, 624, 624*f*
 in membranes, 482
 Ataxia-telangiectasia, 390
 ATCase. *See* Aspartate transcarbamoylase
 α thalassemias, 58, 693*t*
 Atherosclerosis, 254, 565, 720
 cholesterol and, 218, 267, 274
 HDL and, 258
 hyperhomocysteinemia and folic acid supplements in prevention of, 560
 LDL plasma concentration and, 259
 lysophosphatidylcholine and, 217
 α -tocopherol. *See* Tocopherol
 Atorvastatin, 275
 ATP, 115–116, 116*f*, 341*f*, 343, 610, 613
 in active transport, 490–491, 491*f*
 in coupling, 115
 fatty acid oxidation producing, 224, 225–226, 226*t*
 from free energy of catabolism, 131–132
 free energy of hydrolysis of, 115–116, 116*f*
 in free energy transfer from exergonic to endergonic processes, 115, 117*f*
 hydrolysis of
 in muscle contraction, 651, 652*f*, 663
 by NSF, 623
 inorganic pyrophosphate production and, 117–118
 in mitochondrial protein synthesis and import, 614
 in muscle/muscle contraction, 648–649, 651, 654
 multiple sources of, 662*f*
 oxidative phosphorylation, 662
 protein degradation and, 288
 in purine synthesis, 348
 from respiratory control, 131–132, 132*t*
 respiratory control in maintenance of supply of, 167
 synthesis of
 in citric acid cycle, 162*f*, 164, 169*t*, 173
 glucose oxidation yielding, 169*t*, 173
 respiratory chain electron transport in, 130–131, 131*f*, 132*f*
 ATPase, 490–491, 491*f*
 in active transport, 490–491, 491*f*
 chaperones exhibiting activity of, 619
 copper-binding P-type, mutations in gene for Wilson disease caused by, 676
 ATP-binding cassette transporter-1, 258*f*, 259
 ATP-citrate lyase, 166, 166*f*
 acetyl-CoA for lipogenesis and, 234
 ATP synthase, 130, 132*f*
 Atractyloside, on respiratory chain, 132, 132*f*
 α -Tubulin, 665
 Autoantibodies, 684
 Autocrine signaling, 706
 Autoimmune diseases, 565
 Autoimmune response, 687
 Autoimmunity, 684
 Autonomously replicating sequences, 381, 468
 Auto-oxidation. *See* Peroxidation
 Autoradiography, definition of, 468
 Autotrophic organisms, 115
 Avian influenza virus (H5N1), 581
 schematic representation of, 581
 Avidin, biotin deficiency caused by, 560
 Axial ratios, 37
 Axonemal dyneins, 665
 5- or 6-Azacytidine, 344
 5'Azadeoxycytidine, 735, 740*t*
 8-Azaguanine, 344, 344*f*
 Azathioprine, 344, 345*f*
 5- or 6-Azauridine, 344, 344*f*
B
 Bacteria
 intestinal, in bilirubin deconjugation, 332
 transcription cycle in, 397
 Bacterial artificial chromosome (BAC) vector, 455
 Bacterial DNA-dependent RNA polymerase, 397
 Bacterial plasmids, 455
 Bacterial promoters, in transcription, 399*f*
 Bacteriophage, definition of, 468
 BAC vector. *See* Bacterial artificial chromosome (BAC) vector
 BAL. *See* Dimercaprol
 Balanced chemical equations, 74
 β -Alanil dipeptides, 318–320

- β -Alanyl-imidazole, 318
BamHI, 452, 452*t*
 β -Aminoisobutyrate, 318
 β -lipoproteins, 255. *See also* Low density lipoproteins
 β -oxidation of fatty acids, 224–226, 224*f*, 225*f*
ketogenesis regulation and, 229–230, 229*f*
modified, 226, 227*f*
 β sheet, 39
 β thalassemias, 58, 693*t*
Barbiturates, on respiratory chain, 132, 132*f*
Barrel-like structures, 609
Basal laminas, 634
Basal metabolic rate, 542
Base excision-repair of DNA, 389, 390*f*, 390*t*
Base pairing in DNA, 8, 360, 361*f*
matching for renaturation, 361–362
Bases
conjugate, 11
as proton acceptors, 10
strong, 11
weak, 11
Base substitution, mutations occurring by, 416–417, 416*f*
Basic Local Alignment Search Tool. *See* BLAST
Basolateral proteins, 623
Basophils, 700–701, 706
B blood group substances, 697–698, 697*f*
B cyclins, 388*f*, 388*t*
Becker muscular dystrophy, 655
Bends (protein conformation), 39, 40*f*
Benzo[a]pyrene structure, 725*f*
Beriberi, 546
Beta anomers, 154
Bevacizumab, 740*t*
B gene, 697–698
BgIII, 452*t*
 β -Globin gene cluster, schematic representation of, 461*f*
BHA. *See* Butylated hydroxyanisole
BHT. *See* Butylated hydroxytoluene
 β -Hydroxybutyric acid, 347
Bi-Bi reactions, 84, 84*f*
Michaelis-Menten kinetics and, 84
Bicarbonate in extracellular and intracellular fluid, 478*t*
Bilayers, lipid, 480–481, 480*f*
membrane proteins and, 481
Bile acids (salts), 273–274
enterohepatic circulation of, 274
in lipid digestion and absorption, 539
secondary, 273*f*, 274
synthesis of, 273–274, 273*f*
regulation of, 273*f*, 274
Bile, bilirubin secretion into, 331, 331*f*
Bile pigments, 330–332. *See also* Bilirubin
Biliary obstruction, hyperbilirubinemia/ jaundice caused by, 333, 334*t*
Bilirubin
accumulation of (hyperbilirubinemia), 332–333, 332*t*
conjugated
binding to albumin and, 333
reduction, to urobilinogen, 332
conjugation of, 331, 331*f*
fecal, in jaundice, 334*t*
glucuronidation of, 586
heme catabolism producing, 330–332, 330*f*
liver uptake of, 331, 331*f*
normal values for, 334*t*
secretion into bile, 331, 331*f*
unconjugated, disorders occurring in, 332
urine, in jaundice, 333–334, 334*t*
Biliverdin, 330, 330*f*
Biliverdin reductase, 330
Bimolecular membrane layer, 480–481. *See also* Lipid bilayer
Binding change mechanism, 131
Binding constant, Michaelis constant (K_m)
approximating, 81–82
Binding immunoglobulin protein, 616
Binding proteins, 672*t*
Biochemical case histories, 746–754
alcoholism, 747
diabetes mellitus, 746–747, 753–754
Biochemical laboratory tests. *See also* Laboratory (lab) tests
uses of, 590*t*
Biochemistry, 1–4
as basis of health/disease, 3
biomedical importance, 1
history of, 1–2
Human Genome Project and, 3–4, 4*f*
relationship of to medicine, 2–3, 2*f*
Biocytin, 560, 561*f*
Bioenergetics, 113. *See also* ATP
Bioengineering, 3
Bioethics, 3
Bioinformatics, 3, 99, 467
computational biology, 102
computer-aided drug design, 105–107
definition of, 99
genomes and medicine, 98–99
genomic resources for, 101–102
Human Genome Project in, 98
protein function and, 34
proteins, identification of, 102–103
“unknown proteins,” identification of, 103–105
virtual cells, 107
Biologic oxidation. *See* Oxidation
Biology, 3–4
Biomolecules. *See also* specific type
reaction with reactive oxygen species, 759*f*
stabilization of, 8
water affecting structure of, 6–7, 7–8
Biophysics, 3
Biotechnology, 3
Biotin, 560–561, 561*f*
deficiency of, 560–561
in malonyl-CoA synthesis, 233, 233*f*
as prosthetic group, 62
BiP. *See* Binding immunoglobulin protein
2,3-Bisphosphoglycerate, 691
T structure of hemoglobin stabilized by, 57
Bisphosphoglycerate mutase, in glycolysis in erythrocytes, 172, 172*f*
2,3-Bisphosphoglycerate phosphatase, in erythrocytes, 172, 172*f*
BLAST, 103
blastn, 103
blastp, 103
blastx, 103
Blindness, vitamin A deficiency causing, 546
Blood ammonia levels and liver failure, 598, 598*t*
Blood cells, 689–692. *See also* Erythrocytes; Neutrophils; Platelets
derivation from hematopoietic stem cells, 689–690
functional importance, 690–692
pathway of differentiation, 690, 690*f*
reactions of importance in relation to oxidative stress in, 693
Blood clotting. *See* Coagulation (blood)
Blood coagulation, 712*f*. *See also* Coagulation (blood); Coagulation factors
Blood, functions of, 669*t*
Blood glucose. *See* Glucose, blood
Blood group
definition, 696–697
substances, 569
systems, 696–698
Blood plasma. *See* Plasma
Blood transfusion, ABO system importance in, 697
Blood type, 697
Blood vessels, nitric oxide affecting, 660–661
Blotting techniques, 456–457
Blot transfer procedure, 456, 457*f*
Blot transfer techniques, 452
Blunt end ligation/blunt-ended DNA, 453
B lymphocytes, 706–707
 β -Methylaminoalanine, 19*t*
 β_2 -Microglobulin, 676–677
BMR. *See* Basal metabolic rate
 β -N-Glutamylamino-propionitrile (BAPN), 19*t*
 β -N-Oxalyl diamino propionic acid, 19*t*
Body mass index, 541
Body's defense against bacterial infection, neutrophils role in, 700–701
Body water. *See* Water
Bohr effect, 58
in hemoglobin M, 58
Bonds. *See* specific types
Bone
metabolic and genetic diseases, 642*t*
metabolic/genetic disorders, affected by, 642–643
mineralized connective tissue, 640–642
principal proteins, 640*t*
Bone marrow, heme synthesis in, 325
Bone matrix Gla protein, 550*t*
Bone morphogenic proteins (BMPs), 677
Botulinum B toxin, 623
Boundary elements, 444
Bovine nasal cartilage, schematic diagram of, 644*f*
Bovine preproparathyroid hormone, 513*f*
Bovine spongiform encephalopathy, 45
BPG. *See* 2,3-Bisphosphoglycerate
Bradykinin, 713
Brain, metabolism in, 150*t*
glucose as necessity for, 146–147
Branched chain α -ketoacid decarboxylase complex, 300*t*
Branched chain amino acids, catabolism of, 289–290, 308–309, 310*f*
disorders of, 309–311
Branched chain ketonuria (maple syrup urine disease), 309
 α -Ketoacid Decarboxylase Complex impaired function in, 311*t*
Branching enzymes absence of, 179*t*
in glycogen biosynthesis, 178*f*

- Branch point, 178
 Brefeldin A, 623
 Broad beta disease, 275*t*
 Brown adipose tissue, 264, 264*f*
 Brush border enzymes, 538
 BSE. *See* Bovine spongiform encephalopathy
 β subunit of SRP-R, 615
 β -Thalassemias, 460, 693*t*
 structural alterations of, 461*f*
 β -Tubulin, 665
 Budding of vesicles, 621
 Buffers
 Henderson-Hasselbalch equation describing
 behavior of, 12
 weak acids and their salts as, 12–13
 “Bulk flow,” of membrane proteins, 622
 Burkitt’s lymphoma, reciprocal translocation in,
 727*f*
 Bursa of Fabricius, 706
 of neutrophils, 704*t*
 Butylated hydroxyanisole, 220
 Butylated hydroxytoluene, 220
 Butyric acid, 213*t*
 B vitamins. *See* Vitamin B complex
- C**
 Ca²⁺-Na⁺ exchanger, 657
 Cachexia, 148
 CADD. *See* Computer-aided drug design
 Caffeine, 342, 343*f*
 hormonal regulation of lipolysis and, 263
 Calbindin, 541
 Calcidiol (25-hydroxycholecalciferol), in vitamin D
 metabolism, 552*f*
 Calciferol. *See* Vitamin D
 Calcineurin, 655
 Calcinosis, 553
 Calcitonin as tumor biomarker, 739*t*
 Calcitriol (1,25[OH]₂-D₃), 552
 biosynthesis, 508–509
 in kidney, 509
 in liver, 508–509
 in skin, 508
 calcium concentration regulated by, 552
 as tumor biomarker, 739*t*
- Calcium, 552–553
 absorption of, 541
 vitamin D metabolism and, 541, 552–553
 in blood coagulation, 712, 712*f*, 714*t*
 in extracellular fluid, 478, 478*t*
 in intracellular fluid, 478, 478*t*
 iron absorption affected by, 541
 in malignant hyperthermia, 654
 mediator of hormone action, 525–526
 in muscle contraction, 655
 phosphorylase activation and, 180
 sarcoplasmic reticulum and, 656
 in smooth muscle, 659
 in platelet activation, 719*f*, 720
 vitamin D metabolism affected by, 552–553
- Calcium ATPase, 657
 Calcium-binding proteins, vitamin K and
 glutamate carboxylation and postsynthetic
 modification and, 554–555
 synthesis and, 555*f*
 Calcium/calmodulin-sensitive phosphorylase
 kinase, in glycogenolysis, 180
- Calcium channels in cardiac muscle, 656–657
 Calcium-dependent hormone action and
 phosphatidylinositide metabolism,
 525–526
 Calcium metabolism, 524
 Calcium-sodium exchanger, 657
 Caldesmon, 660
 Calmodulin, 524, 659
 muscle phosphorylase and, 180, 181*f*
 Calmodulin-4 Ca²⁺, in smooth muscle contraction,
 659
 Calnexin, 576–577, 618
 Calnexin cycle, model of, 576–577
 Calreticulin, 618
 ER protein, 577
 Calsequestrin, 653, 655
 cAMP. *See* Cyclic AMP
 CAMs. *See* Cell adhesion molecules
 Cancer, 565
 anticancer agents for, 739*t*
 anticancer drug targets, 741*f*
 causes of, 724
 clonal origin, 723
 drug resistance, 741*t*
 epigenetic mechanisms, 735–736
 hereditary predisposition to, 732
 immunologic aspects of, 741–742
 inflammation and obesity relation to, 742
 metastasis and, 736–738
 mitochondria involvement in, 738
 oncogenes and tumor suppressor genes in,
 726–730
 polypeptide growth factors relationship with, 730
 prevalence, 722
 prevention by modifiable risk factors, 730, 731*t*
 spread of, 736
 stem cells role in, 736
 types of, 722
- Cancer cachexia, 172, 543
 Cancer cells, 577, 580
 abnormalities of apoptosis, 733–735
 aerobic glycolysis rate in, 739
 aneuploidy of, 731
 angiogenesis stimulation by, 736
 biochemical and genetic changes occurring in,
 623*f*
 cell cycle abnormalities in, 730–731
 cyclins and, 389
 elevated levels of telomerase activity in, 732
 exome sequencing, benefits of, 732–733
 genomic instability of, 731–732
 hormone-dependent, vitamin B₆ deficiency
 and, 557
 membrane abnormalities and, 496*t*
 metastatic properties of, 580
 properties of, 623*f*, 722
 pyruvate kinase isozymes and glycolysis in, 739*f*
 Warburg effect in, 738
 ways of evading apoptosis, 734–735
 whole genome sequencing, benefits of, 732–733
- Cancer chemotherapy
 folate inhibitors in, 559
 synthetic nucleotide analogs in, 343–344, 344*f*,
 345*f*
- Cancer Genome Atlas, 102
 Cancer phototherapy, porphyrins in, 327
 CAP. *See* Catabolite gene activator protein
- Caproic acid, 213*t*
 Caps, 620
 Carbamates, hemoglobin, 56
 Carbamoyl phosphate
 excess, 356
 free energy of hydrolysis of, 116*t*
 in urea synthesis, 293, 293*f*, 294
 Carbamoyl phosphate synthetase
 carbamoyl phosphate synthetase I, 293, 294
 deficiency of, 295, 295*t*
 in urea synthesis, 293, 293*f*, 294
 carbamoyl phosphate synthetase II, in
 pyrimidine synthesis, 352, 353*f*
- Carbohydrate-binding proteins, 572
 Carbohydrate complex. *See* specific types
 Carbohydrates, 152–160. *See also* Glucose; Sugars;
 specific types
 in cell membranes, 159
 cell surface and glycolipids, 152
 classification of, 152–153, 153*t*
 digestion and absorption of, 538
 in fatty acid synthesis, 145
 interconvertibility of, 145
 isomerism of, 153–154, 154*f*
 in lipoproteins, 159
 metabolism of, 140, 140*f*, 141*f*
 diseases associated with, 152
 vitamin B₁ in, 550*t*
 very low weight loss from diets with, 194
- Carbon dioxide
 citric acid cycle in production of, 161–162, 163*f*
 transport of, by hemoglobin, 56
- Carbonic acid, pK/pK_a value of, 12, 13*t*
 Carbonic anhydrase II (CA II), 643
 Carbon monoxide
 heme catabolism producing, 330
 on oxidative phosphorylation, 127
 on respiratory chain, 132, 132*f*
- Carbon skeleton, amino acid. *See* Amino acid
 carbon skeletons
- Carboxybiotin, 560, 561*f*
 Carboxylase enzymes, biotin as coenzyme of, 561
 Carboxypeptidases, 539
 Carcinoembryonic antigen, 592, 739*t*, 740
 Carcinogenesis, 723–724
 Carcinoid (argentaffinoma), serotonin in, 316
 Carcinoid syndrome, 557
 Cardiac developmental defects, 659
 Cardiac glycosides, 156
 Cardiac muscle, 653
 calcium channels in, 656–657
 resembles skeletal muscle, 656–657
- Cardiac troponins, 69
 Cardiolipin, 127, 216*f*, 217
 synthesis of, 246, 246*f*, 248, 248*f*
 Cardiomyocytes, turnover rate of, 757*t*
 Cardiomyopathies, 647, 657–658
 Cardiovascular system, 632
 Cargo proteins/molecules, 622
 in export, 612
 in import, 612, 612*f*
- Carnitine
 deficiency of, 223, 231
 in fatty acid transport, 224, 224*f*
 liver and muscle, 751*t*
 urinary excretion of, 752*t*
 Carnitine-acylcarnitine translocase, 224, 224*f*

- Carnitine palmitoyltransferase, 223
 Carnitine palmitoyltransferase-I, 224, 224f
 deficiency of, 231
 in ketogenesis regulation, 229, 229f
 Carnitine palmitoyltransferase-II, 224, 224f
 deficiency of, 231
 Carnitine system, 132
 Carnosinase deficiency, 319
 Carnosine, 315, 316f, 319
 Carnosinuria, 319
 Carotene, 564, 567
 Carotene dioxygenase, 547
 Carotenoids, 547. *See also* Vitamin A
 Carrier proteins/systems, 487
 Cartilage
 components of, 643
 metabolic and genetic diseases, 642t
 principal proteins of, 643t
 schematic representation of, 644f
 Cascade, 685
 Caspase-activated DNase, 733
 Caspases, 733
 Catabolic pathways/catabolism, 114, 139. *See also*
 Exergonic reaction; Metabolism; specific
 substances
 energy captured in, from respiratory chain,
 131–132, 131f
 Catabolite gene activator protein, 431
 Catabolite regulatory protein, 522
 Catalase, 122, 693
 as antioxidant, 220
 in nitrogen metabolism, 291, 292f
 Catalysis/catalytic reactions (enzymatic). *See also*
 Metabolism
 acid-base, 63
 HIV protease in, 64, 64f
 at active site, 62–63
 Bi-Bi reactions, 84
 Michaelis-Menten kinetics, 84
 coenzymes/cofactors in, 61–62
 conservation of residues and, 66
 covalent, 63, 77
 chymotrypsin in, 64–65, 77
 fructose-2,6-bisphosphatase in, 65f
 double displacement, 84
 enzyme detection facilitated by, 66–68
 equilibrium constant and, 76–77
 isozymes and, 66
 kinetics of, 77
 activation energy affecting, 74–75
 balanced equations and, 74
 competitive vs. noncompetitive inhibition
 and, 81
 in drug development, 85
 factors affecting rates of, 75–77
 free energy changes and, 75
 initial velocity and, 78
 models of, 79
 substrate concentration and, 78–79
 transition states and, 81
 mechanisms of
 chymotrypsin, 64–65
 prosthetic groups/cofactors/coenzymes in,
 61–62
 site-directed mutagenesis in study of, 71
 oxaloacetate and, 162
 ping-pong, 84, 85f
 prosthetic groups in, 61–62
 by proximity, 63
 regulation of, 87–96, 88f, 145, 146f
 active and passive processes in, 88, 88f
 allosteric, 90–91, 90f, 145, 146f
 compartmentation in, 88–89
 covalent, 90, 92, 93f
 enzyme quantity and, 89–90
 feedback inhibition and, 90f, 91
 feedback regulation and, 91, 145
 metabolite flow and, 88
 Michaelis constant (K_m) in, 88, 88f
 phosphorylation-dephosphorylation in,
 93f, 94t
 proteolysis in, 92, 93f
 sequential displacement, 84
 specificity of, 61
 by strain, 63
 substrate concentration affecting rate of, 78–79
 Hill model of, 79
 Michaelis-Menten model of, 79
 Catalytic constant, 80
 Catalytic efficiency, 80
 Catalytic residues, conserved, 64f, 66
 Catalytic site, 91. *See also* Active site
 Cataracts, diabetic, 205
 Catecholamine biosynthesis, 509f
 dopa decarboxylase in, 509–510
 dopamine β -hydroxylase in, 510
 PNMT in, 510
 tyrosine hydroxylase in, 510
 Catecholamines. *See also* Catecholamine
 biosynthesis; specific type biosynthesis
 storage of, 515t
 Cation. *See also* specific cations
 membrane penetration by, 134
 Caveolae, 484
 Caveolin-1, 484
 CBG. *See* Corticosteroid-binding globulin
 CBP. *See* CREB-binding protein
 CBP/p300 and signal transduction pathways, 532f
 CDG. *See* Congenital disorders of glycosylation
 CDK-cyclin inhibitor/CDKI, DNA/chromosome
 integrity and, 392
 CDKs. *See* Cyclin-dependent protein kinases
 cDNA library, 456
 CDRs. *See* Complementarity-determining regions
 CEA. *See* Carcinoembryonic antigen
 Celiac disease, 537
 Cell adhesion, glycosphingolipids in, 250
 Cell adhesion molecules, 736, 738t
 Cell-cell communication, via gap junctions, 495f
 Cell-cell interactions, 477
 Cell cycle
 abnormalities in cancer cells, 730–731
 basic aspects of, 731
 regulation, 620
 S phase of, DNA synthesis during, 388–389,
 388f, 388t
 Cell death, 248, 250
 Cell-free systems, vesicles studied in, 621
 Cell fusion, 685
 Cell injury (cytotoxicity), 587, 587t
 Cell in macromolecule transport, 492–493, 492f,
 495f
 Cell-mediated immunity, 681
 Cell membrane. *See* Plasma membrane
 Cell migration, 634
 Cell recognition, glycosphingolipids in, 250
 Cell sap. *See* Cytosol
 Cell surface carbohydrates, glycolipids and, 218
 Cellular injury, ROS role in, 693
 Cellular membranes, proteins of, 569
 Cellulose, 156, 158f
 Cellulose acetate zone electrophoresis, 669, 670f
 Central core disease, 655
 Central nervous system, glucose as metabolic
 necessity for, 146–147
 Centromere, 374, 375f
 Cephalin (phosphatidylethanolamine), 216, 216f
 membrane asymmetry and, 482
 synthesis of, 246, 246f
 Ceramide, 216, 217f, 249–250, 250f
 in membranes, 479
 synthesis of, 249–250, 250f
 Cerebrohepatorenal (Zellweger) syndrome, 231,
 614, 614t
 Cerebrosides, 250
 Ceruloplasmin, 672
 deficiency of, 675–676
 diagnostic significance of, 68t, 676
 Cervonic acid, 213t
 CF. *See* Cystic fibrosis
 CFTR. *See* Cystic fibrosis transmembrane
 regulator
 cGMP (cyclic GMP), 501t
 Chain elongation. *See* Elongation
 Chain initiation. *See also* Initiation
 in transcription cycle, 396f, 399f
 Chain termination. *See also* Termination
 in transcription cycle, 396f
 Channeling, in citric acid cycle, 162
 Channelopathies, 657
 Chaperones, 45, 618–619, 618t
 ATPase activity of, 619
 ATP-dependent protein binding to, 610, 620
 histone, 373
 in protein sorting, 608–610, 609t, 625t
 Chaperonins, 45, 609–610
 Charged paddle, 488f, 489, 490f
 Charge-relay network, 65
 Charging, in protein synthesis, 415, 415f
 Checkpoint controls, 391
 Chèdiak-Higashi syndrome, 619t
 Chemical carcinogenesis, 724–725
 stages of, 725
 Chemical carcinogens
 and cancer, 724–726
 direct and indirect, 725f
 interaction with DNA, 724
 structures of, 725f
 variety of, 724t
 Chemical mechanisms and reactive oxygen species
 (ROS), 762
 Chemiosmotic theory, 132–133
 on respiratory control, 130, 131f, 132–133
 Chemokines, 702, 702f, 706
 Chemotaxis, 706
 by G-protein coupled receptors, 702
 Chemotherapy for cancer treatment
 folate inhibitors in, 559
 synthetic nucleotide analogs in, 343–344, 344f,
 345f
 Chenodeoxycholic acid, 273, 273f, 274

- Chenodeoxycheryl-CoA, 273, 273f
 Chimeric gene approach, 442–443
 Chimeric molecules, 452–454, 468
 Chips, gene array, protein expression and, 33
 Chitin, 157, 158f
 Chloramines, 705
 Chloride
 in extracellular and intracellular fluid, 478, 478t
 permeability coefficient of, 481f
 Chlorinated oxidants, production of, 705
 Chlorophyll, 323
 Cholecalciferol (vitamin D₃)
 skin synthesis of, 552
 in vitamin D metabolism, 552
 Cholera
 early epidemiology of, 100
 glucose transport in treatment of, 491
 toxin, 250
 Cholestatic jaundice, 333
 Cholesterol, 218, 219, 219f, 253, 254, 270f, 539, 624
 in bile acid synthesis, 273–274, 273f
 dietary, 267
 excess of. *See* Hypercholesterolemia
 excretion of, 273–274, 273f
 in lipoprotein, 253, 254, 255f
 in membranes, 479
 fluid mosaic model and, 484
 metabolism of, 141f, 143
 clinical aspects of, 270–276, 274–276, 275t
 diurnal variations in, 270
 high-density lipoproteins in, 258–259, 258f
 plasma levels of
 atherosclerosis and coronary heart disease
 and, 274
 dietary changes affecting, 274
 drug therapy affecting, 275
 lifestyle changes affecting, 274
 synthesis of, 267–270, 267f, 268f, 269f
 acetyl-CoA in, 141, 141f, 267–270, 267f, 269f
 carbohydrate metabolism and, 140
 HMG-CoA reductase in regulation of, 270
 in tissues, 219, 219f
 factors affecting balance of, 270–271, 271f
 transport of, 271–272, 272f
 reverse, 258f, 259, 267, 271f, 274
 Cholesterol derivatives, 502f
 Cholesterol side-chain cleavage and basic steroid
 hormone structures, 503f
 Cholesteryl ester hydrolase, 270–271
 Cholesteryl esters, 219, 253, 254, 270
 in lipoprotein core, 254, 255f
 Cholesteryl ester transfer protein, 272, 272f, 274
 Cholic acid, 273
 Choline, 216, 216f
 deficiency of, fatty liver and, 261
 in glycine synthesis, 283, 284f
 membrane asymmetry and, 482
 Choluric jaundice, 333
 Cholyl-CoA, in bile acid synthesis, 273, 273f
 Chondrodysplasias, 643, 645
 molecular bases of, 645
 Chondroitin sulfate, 159, 159f, 637, 640
 Chondronectin, 643
 Christmas factor (factor IX), 712, 712f, 713f, 714t
 coumarin drugs affecting, 717
 deficiency of, 718
 Chromatids, 375t, 381f
 nucleoprotein packing in, 375
 sister, 374, 375f
 exchanges between, 380
 Chromatin, 371–374, 372f, 373t
 active vs. inactive regions of, 373–374, 374f
 higher order structure/compaction of, 372f, 373
 inactive, 373–374
 reconstitution in DNA replication, 387–388
 remodeling in gene expression, 437–438
 Chromatin immunoprecipitation (ChIP), 465
 Chromatin modifying complex, 439
 Chromatin remodeling, 735
 Chromatography. *See also* specific type
 affinity
 for protein/peptide purification, 28
 for recombinant fusion protein purification,
 70
 for protein/peptide purification, 26–29
 Chromium, 562t
 Chromosomal instability, 731, 731f
 Chromosomal integration, 379–380, 380f
 Chromosomal recombination, 379, 379f, 380f
 Chromosomal translocation, 726, 726t
 Chromosomal transposition, 380
 Chromosomes, 372f, 374–376, 375t, 376f
 integrity of, monitoring, 390–392
 interphase, chromatin fibers in, 373
 metaphase, 372f, 375, 375t
 polytene, 374
 Chromosome walking, 463
 Chronic granulomatous disease, 705
 Chronic inflammation, 742
 Chyle, 255
 Chylomicron remnants, 254t, 255, 257f
 liver uptake of, 258
 Chylomicrons, 143, 148, 253, 254, 254t
 apolipoproteins of, 254t, 255
 metabolism of, 143, 147f, 255–258, 257f
 in triacylglycerol transport, 255–257, 256f, 257f
 Chymotrypsin, 65f, 539
 conserved residues and, 66t
 in covalent catalysis, 64–65
 in digestion, 539
 Chymotrypsinogen, 539
 CI. *See* Chromosomal instability
 ci repressor protein/ci repressor gene, 434, 435f
 Cirrhosis of liver, 161, 261
 CI, schematic molecular structures of, 434f
 Cisternal maturation, 623
 cis-/trans-Epigenetic signals, 438, 439f
 Cistron, 430
 Citrate
 in citric acid cycle, 161, 162f
 in lipogenesis regulation, 234
 Citrate synthase, 162, 163f
 Citric acid cycle, 117, 127, 145, 161–167, 162f, 163f
 ATP generated by, 162f, 164, 169t, 173
 carbon dioxide liberated by, 161–162, 163f
 deamination and, 164–165
 gluconeogenesis and, 164, 165f, 185–187, 186f
 in metabolism, 140, 140f, 141f, 143, 144f,
 161–162, 164–165, 165f
 amino acid, 140f, 141f
 carbohydrate, 140, 140f, 164, 165f
 lipid/fatty acid, 140f, 141, 165–168, 166f
 at subcellular level, 144, 144f
 in mitochondria, 143, 144, 144f
 reducing equivalents liberated by, 162–164, 163f
 regulation of, 166–167
 respiratory chain substrates provided by,
 161–162, 162f
 transamination and, 165, 165f
 vitamins role in, 164
 Citric acid, pK_a/pK_a value of, 13t
 Citrullination, 705–706, 705f
 Citrulline, 19t
 in urea synthesis, 292, 294
 Citrullinemia, 295
 CJD. *See* Creutzfeldt-Jakob disease
 CK. *See* Creatine kinase
 Cl. *See* Chloride
 Class B scavenger receptor B₁, 258f, 259
 Classical chemotherapeutic drugs, 740
 Classic pathway of complement activation, 685
 Class (isotype) switching, 684
 Clathrin, 271, 492f, 493
 Clathrin-coated vesicles, 621
 Clathrin-free vesicles, 621
 Clearance tests, 597
 Cleavage
 of prealbumin, to proalbumin, 623f
 of ubiquitin, 620
 Clinical chemistry
 enzymes in, 594–595, 595f
 techniques used in, 593–596
 Clinical deficiency disease. *See also* specific
 diseases
 vitamin and, 546
 Clinical medicine. *See also* Laboratory (lab) tests
 laboratory (lab) tests importance in, 589
 Clofibrate, 275
 Clones in monoclonal antibody production, 685
 Cloning, 454–455
 Cloning vectors, 454–455, 455t
 DNA insert size, 455t
 Clopidogrel, 721
 Clotting factors, 713t. *See also* specific type under
 Factor
 vitamin K in synthesis of, 553–555
 CMC. *See* Chromatin modifying complex
 CMDs. *See* Congenital muscular dystrophies
 CMP. *See* Cytidine monophosphate
 CMP-sialic acids, 571
 CNV. *See* Copy number variations
 CO. *See* Carbon monoxide
 CO₂. *See* Carbon dioxide
 Coactivators, transcription, 403, 404–405
 Coagulation (blood), 711
 endothelial cell products in, 720–721, 721t
 extrinsic pathway of, 712–713, 712f, 714t
 fibrin formation in, 712, 712f, 715–717, 716f
 intrinsic pathway of, 712, 712f, 713–714, 714t
 laboratory tests in evaluation of, 721
 pathways of, 712f
 prostaglandins in, 232
 proteins involved in, 713f, 714t. *See also*
 Coagulation factors
 vitamin K in, 554
 coumarin anticoagulants affecting, 717
 Coagulation factors, 713t. *See also* specific type
 under Factor
 vitamin K in synthesis of, 554
 Coating, vesicle
 brefeldin A affecting, 622f, 623

- Coat proteins
 function of, 621–622
 recruitment of, 621–622, 622*f*
- Cobalamin, 558, 558*f*
 absorption of, intrinsic factor in, 541
 in methylmalonic aciduria, 187
- Cobalophilin, 558
- Cobalt, 558
- Cobamide, coenzymes derived from, 62
- Code erasers, 437
- Code readers, 437
- Code writers, 437
- Coding regions, 376, 376*f*
- Coding strand, 360, 399*f*
 in RNA synthesis, 394
- Codons, 413, 414*t*
 amino acid sequence of encoded protein
 specified by, 414
 nonsense, 414
- Codon usage tables, 415
- Coenzyme Q, 127
- Coenzymes, 62, 344*t*
 in catalysis, 62
 coenzyme A synthesis, 561, 561*f*
 nucleotide derivatives, 343
- Cofactors, 62
 in blood coagulation, 712, 714*t*, 717
 in catalysis, 62
 in citric acid cycle regulation, 164
- Cognate receptor, 520
- Colipase, 539
- Collagen, 46–47, 426
 animal world, abundant protein, 627
 in bone, 640–643
 in cartilage, 643, 643*t*
 cell interacting, schematic representation of,
 634*f*
 chondrodysplasias, 630, 643, 645
 classification of, 629*f*, 629*t*
 cross-linking of, 578
 elastin differentiated from, 632*t*
 fibril formation by, 628
 genes for, 627, 628*t*
 diseases caused by mutations in, 47, 630, 630*t*
 glycation of, 578
 maturation/synthesis of, 47
 ascorbic acid in, 47, 562
 disorders of, 47
 mutations, 630, 630*t*
 osteogenesis imperfecta, 642, 642*t*
 in platelet activation, 719*f*, 720
 posttranslational modification of, 629–630
 triple helix structure of, 46–47, 46*f*, 627–631
 type I, 640
 type IV, 631
 type IX, 630
 types of, 628*t*
 type V, 640
- Collagens, 573
- Collision-induced dissociation, in mass
 spectrometry, 31
- Collision (kinetic) theory, 75
- Colon cancer. *See* Colorectal cancer
- Colony-stimulating factor, 690
- Colorectal cancer
 development of
 genes associated with, 729*f*
 genetic changes associated with, 729*f*
 tumor suppressor genes and oncogenes role
 in, 728–730, 729*f*
 mismatch repair genes in, 390*t*
- Column chromatography, for protein/peptide
 purification, 26
- Combinatorial chemistry, 67
- Combinatorial diversity, 684
- Common lymphoid progenitor, 701
- Common myeloid progenitor, 701
- Compartmentation, 88–89
- Competitive inhibition, noncompetitive inhibition
 differentiated from, 81–84
- Competitive ligand-binding assays, 595–596
- Complementarity
 of DNA, 362*f*
 of RNA, 366, 367*f*
- Complementarity-determining regions, 683
- Complementary DNA (cDNA) library, 455
- Complement system (cascade), 685–686, 686*f*
- Computational biology, 102
 definition of, 102
 genomes and medicine, 98–99
 genomic resources for, 101–102
 Human Genome Project in, 98
- Computer-aided drug design, 105–107
- ConA. *See* Concanavalin A
- Concanavalin A, 159
- Conformation. *See also* specific substances
 native, 44
 polypeptide/protein, 26*f*
- Conformational disorders, 625
- Conformers, virtual library, 106*f*
- Congenital contractural arachnodactyly, 632
- Congenital disorders of glycosylation, 580, 674
- Congenital forms of muscular dystrophy, 655
- Congenital long QT syndrome, 496*t*
- Congenital muscular dystrophies, 580
- Congenital nonhemolytic jaundice (type I
 Crigler-Najjar syndrome), 333
- Conjugate acid, 11
- Conjugate base, 11
- Conjugated bilirubin
 binding to albumin and, 333
 reduction, to urobilinogen, 332
- Conjugated hyperbilirubinemia, causes of, 332*t*,
 333
- Conjugating enzyme, 620
- Conjugation of bilirubin, 331, 331*f*
- Conjugation reactions, xenobiotics metabolism
 acetylation, 586–587
 glucuronidation of bilirubin, 586
 methylation, 587
 sulfation, 586
- Connexin, 494, 495*f*
- Consensus sequences, 403, 407*f*
 Kozak, 421
- Conservation of energy, 116–117
- Conserved residues, 66
- Constant regions/segments, 681
 gene for, 684
- Constitutive gene expression, 430, 433
- Constitutive heterochromatin, 374
- Constitutive mutation, 430
- Constitutive secretion, 608
- Contact sites, 610
- Contractility/contraction. *See* Muscle contraction
- Cooperative binding
 hemoglobin, 55
 Bohr effect on, 56
 Hill equation describing, 81
- COPII vesicles, 618, 621, 621*t*
- COPI vesicles, 618, 621, 621*t*
- Coplanar atoms, partial double-bond character
 and, 23
- Copper, 561
 ceruloplasmin in binding of, 675
 as cofactor, 675
 enzymes containing, 675
 in Wilson disease, 676
- Copper-binding P-type ATPase, mutations in gene
 for, 676
- Copper toxicosis, 676. *See also* Wilson disease
- Coproporphyrinogen I, 326, 326*f*, 328*f*
- Coproporphyrinogen III, 326, 326*f*, 328*f*
- Coproporphyrinogen oxidase, 326, 326*f*, 328*f*
 in porphyria, 328*t*
- Coproporphyrins, 324*f*, 327
 spectrophotometry for detection of, 327–329
- Coprostanol (coprosterol), 273
- Copy number variations, 460, 731
- Coregulators, transcription, 403
- Cori cycle, 190, 191*f*
- Cori disease, 179*t*
- Coronary artery disease, 565
- Coronary (ischemic) heart disease. *See also*
 Atherosclerosis
 cholesterol and, 274
- Corticoids, 558. *See also* Cobalamin
- Corticosteroid-binding globulin, 516, 672*t*
- Corticotropin. *See* Adrenocorticotrophic hormone
- Cortisol synthesis, 504
- Cosmids, 454, 455
- Cos sites, 455
- Cothromboplastin (factor VII), 712, 712*f*
 coumarin drugs affecting, 717
 in initiation of blood coagulation, 712, 713*t*
- Cotranslational glycosylation, 615
- Cotranslational insertion, 615*f*, 616, 618
- Cotransport systems, 486*f*
- Coulomb's law, 7
- Coumarin, 717
- Coupling, 114, 114*f*
 ATP in, 115
- Covalent bonds, 7*t*
 biologic molecules stabilized by, 7–8
 membrane lipid-protein interaction and, 481
- Covalent catalysis, 63, 63*f*, 77
 chymotrypsin in, 64–65, 77
- Covalent cross-links, 628
- Covalent modification
 mass spectrometry in detection of, 31, 31*t*
 in regulation of enzymatic catalysis, 90, 92,
 93*f*. *See also* Phosphorylation, protein;
 Proteolysis
 gluconeogenesis regulation and, 188
 irreversible, 92, 93*f*
 metabolite flow and, 92
 reversible, 92, 93*f*, 94*t*
- Coxibs, 240
- C20 polyunsaturated acids, eicosanoids formed
 from, 239, 240*f*, 241*f*
- CPT-I. *See* Carnitine palmitoyltransferase-I
- CRE. *See* Cyclic AMP response element

- C-reactive protein, 590, 671, 672*t*
 Creatine, 318, 320*f*
 Creatine kinase, 127, 135, 663
 diagnostic significance of, 69
 Creatine phosphate, 314*f*, 318, 320*f*, 663
 free energy of hydrolysis of, 116*t*
 in muscle, 663*t*
 Creatine phosphate shuttle, 135, 135*f*
 Creatinine, 318, 320*f*
 as marker of renal function, 597
 Creatinine clearance, 597
 CREB (cyclic AMP response element binding protein), 523
 CREB-binding protein, 531
 C regions/segments. *See* Constant regions/segments
 Creutzfeldt-Jakob disease, 45–46
 Crigler-Najjar syndrome
 type I (congenital nonhemolytic jaundice), 333
 type II, 333
 Cro binds, 435
cro gene, 434, 434*f*, 435*f*
 Cro protein, 3D structure of, 445*f*
 Cross-bridges, 649, 652*f*, 660
 Crossing-over, in chromosomal recombination, 379, 379*f*, 381*f*
 CRP. *See* Catabolite regulatory protein; C-reactive protein
 Cryo-electron microscopy, 44
 Cryoprecipitates, recombinant DNA technology in production of, 718
 Cryptoxanthin, 547
 Crystallography, x-ray, protein structure demonstrated by, 41–43
 CSF. *See* Colony-stimulating factor
 CT. *See* Calcitonin
 C-terminal-binding domain, 40
 CTP. *See* Cytidine triphosphate
 Cultured cells, 581
 Cyanide
 on oxidative phosphorylation, 127
 on respiratory chain, 132, 132*f*
 Cyclic 3',5'-nucleotide phosphodiesterase, in lipolysis, 263
 Cyclic AMP, 179, 180*f*, 343, 343*f*, 344*t*
 adenyl cyclase affecting, 179, 521–522, 521*t*
 in gluconeogenesis, 189, 190*f*, 193
 in glycogen metabolism regulation, 179–180, 181*f*, 183*f*
 phosphodiesterases, 523
 phosphoprotein phosphatases and, 523–524
 phosphoproteins, 523
 protein kinases and, 522–523
 as second messenger, 179
 smooth muscle contraction affected by, 660
 Cyclic AMP-dependent protein kinase, 42*f*. *See also* Protein kinases
 Cyclic AMP regulatory protein (catabolite gene activator protein), 431
 Cyclic AMP response element binding protein (CREB), 523
 Cyclic GMP, 343, 343*f*, 501*t*
 formation, 524
 as intracellular signal, 524
 role in smooth muscle, 660–661
 as second messenger, 343
 Cyclin-dependent protein kinases, 388, 388*f*, 388*t*
 inhibition of, DNA/chromosome integrity and, 392
 Cyclins, 388–389, 388*f*, 388*t*
 Cycloheximide, 426
 Cyclooxygenase pathway, 240–241, 241*f*, 242*f*, 720–721
 Cystathionine- β -synthase, 300*t*
 Cysteine, 17*t*, 314–315
 conversion to taurine, 315*f*
 metabolism of, 301–302, 303*f*
 abnormalities of, 301–303, 303*f*
 in pyruvate formation, 301–303, 303*f*
 requirements for, 544
 synthesis of, 284–285, 285*f*
 Cystic fibrosis, 496, 496*t*, 537
 Cystic fibrosis transmembrane regulator, 496
 degradation of, 620
 Cystine reductase, 301, 302*f*
 Cystinosis (cystine storage disease), 303
 Cystinuria (cystine-lysinuria), 301
 Cytarabine (arabinosylcytosine), 344, 345*f*
 Cytidine, 341*f*, 341*t*
 Cytidine monophosphate, 341*t*, 571
 Cytidine triphosphate, 343
 in phosphorylation, 118
 Cytochrome a_3 , 120
 Cytochrome c oxidase, 127, 128*f*
 Cytochrome oxidase, 120
 Cytochrome P450-dependent microsomal ethanol oxidizing system, 261
 Cytochrome P450 side chain cleavage enzyme (P450 $_{sc}$), 503
 Cytochrome P450 system, 119, 123–124, 123*f*, 124*f*, 584–585, 618
 ALA synthase affected by, 327, 330
 enzyme induction and, 330
 families of, 584*t*
 isoforms of, 584–585
 in endoplasmic reticulum of human liver, 584–585
 nomenclature for, 584
 in tissues, 584
 membrane insertion, 616
 mitochondrial, 123–124
 polymorphism of, 585
 properties of, 585*t*
 reaction catalyzed by, 584
 superfamily of heme-containing enzymes, 584
 Cytochromes
 cytochrome a_3 , 120
 cytochrome b_5 , 124, 618, 692
 cytochrome b_{558} , 704
 as dehydrogenases, 121–122
 Cytokines, 671, 706
 in cachexia, 148
 Cytosine, 341*t*, 357*f*
 base pairing in DNA, 361*f*
 deoxyribonucleosides of, in pyrimidine synthesis, 352–351
 Cytoskeleton/cytoskeletal proteins, 647
 Cytoskeleton, multiple cellular functions, 664–666
 Cytosol, 616
 ALA synthesis in, 325, 325*f*
 glycolysis in, 144, 144*f*, 169
 lipogenesis in, 232–236, 235*f*, 237
 pentose phosphate pathway reactions in, 198–200
 pyrimidine synthesis in, 352
 Cytosolic branch, for protein sorting, 608*f*, 610–614
 Cytotoxic T cells, 707
- ## D
- D-3-Hydroxybutyrate dehydrogenase, 226, 227*f*
 DAF. *See* Decay accelerating factor
 D-amino acids, free, 20
 dAMP, 342*f*
 Dantrolene, for malignant hyperthermia, 654
 D-Arabinose, 155*t*
 D arm of tRNA, 366, 416
 Database of Genotype and Phenotype, 102
 Databases, 99
 dbGAP. *See* Database of Genotype and Phenotype
 DBH. *See* Dopamine β -hydroxylase
 D cyclins, 388, 388*f*, 388*t*
 cancer and, 389
 Dcytb. *See* Duodenal cytochrome b
 Deamination, 141, 141*f*
 citric acid cycle in, 164
 liver in, 143
 Death receptor pathway, 733
 Debranching enzymes
 absence of, 179*t*
 in glycogenolysis, 178, 178*f*
 Decarboxylation of S-adenosylmethionine, 316
 Decay accelerating factor, 580
 Defensins, 704*t*
 Degeneracy, of genetic code, 414
 Degradation, of virus, 620
 Dehydrocholesterol, in vitamin D metabolism, 547
 Dehydroepiandrosterone, 505
 Dehydrogenases, 120–122, 122*f*
 in enzyme detection, 68, 69
 nicotinamide coenzyme-dependent, 121, 122*f*
 in respiratory chain, 120–122
 riboflavin-dependent, 121
 Denaturation
 DNA structure analysis and, 361
 protein refolding and, 45
 temperature and, 77–78
 Deoxyadenylate, 359
 Deoxycholic acid, synthesis of, 274
 Deoxycytidine residues, methylation of, 438
 Deoxycytidylate, 359
 Deoxyguanylate, 359
 Deoxyhemoglobin
 deoxyhemoglobin S, “sticky patch” receptor on, 58*f*
 proton binding by, 56
 Deoxyhemoglobin A, “sticky patch” receptor on, 56, 58*f*
 Deoxynucleotides, 359–361
 Deoxyribonucleases (DNase)/DNase I, 368
 active chromatin and, 373
 Deoxyribonucleic acid. *See* DNA
 Deoxyribonucleoside diphosphates, reduction of NDPs to, 352*f*
 Deoxyribonucleosides, 340
 in pyrimidine synthesis, 352–351
 Deoxyribose, 152, 156, 156*f*
 Deoxy sugars, 156, 156*f*
 3-Deoxyuridine, 344

- Dephosphorylation. *See also* Phosphorylation, protein
in covalent modification, 94–95, 94t
- Depolarization, in nerve impulse transmission, 491
- Dermatan sulfate, 638
- Designer medicine, challenges of, 99
- Desmin, 655
- Desmosomes, 484
- Desmosterol, in cholesterol synthesis, 269, 269f
- Detergents, 480
- Detoxification, cytochrome P450 system in, 123–124, 123f, 124f
- Developmental biology, test subject for studying, 766
- Dexamethasone suppression test, 599
- Dextrinosis, limit, 179t
- Dextrins, 156
- Dextrose, 154
- D-Fructofuranose, 154f
- D-Fructopyranose, 154f
- D-Fructose, 155f, 155t
- D-Galactosamine (chondrosamine), 156
- D-Glucufuranose, 154f
- D-Glucopyranose, 154f
- D-Glucose, 154f, 155t
- D-Glucuronate, 154–155, 156f
- DHA. *See* Docosahexaenoic acid
- DHEA. *See* Dehydroepiandrosterone
- DHPR. *See* Dihydropyridine receptor
- DHT. *See* Dihydrotestosterone
- Diabetes mellitus, 152, 192, 254
case study, 746–747, 753–754
fatty liver and, 261
free fatty acid levels in, 255
hyperglycemia in, 149
ketosis/ketoacidosis in, 231
lipid transport and storage disorders, 254
lipogenesis in, 232, 236
as metabolic disease, 140
tissue damage in, 578–579
- Diabetic cataract, 205
- Diacylglycerol, 215, 539, 702
formation of, 246f
in platelet activation, 719f, 720
- Diacylglycerol acyltransferase, 246, 247f
- Diagnostic enzymology, 68
- Diagnostic test. *See* Laboratory (lab) tests
- Diagnostic window, 68
- 2,4-Diaminobutyric acid, 19t
- Diamond–Blackfan anemia, 692
- Diapedesis, 701, 701f
- Diarrhea, 581
glucose transport in treatment of severe, 491
- Dicarboxylic aciduria, 231
- Dicer nuclease, 409
- Dicumarol (4-hydroxydicoumarin), 554
- Dielectric constant, of water, 7
- Diet. *See also* Nutrition
blood glucose regulation and, 190
cholesterol levels affected by, 274, 275
hepatic VLDL secretion and, 259–260, 260f
high-fat, fatty liver and, 261
very low carbohydrate, weight loss from, 194
- Diethylenetriaminepentaacetate (DTPA), as preventive antioxidant, 220
- Diet-induced thermogenesis, 264, 542
- Diffusion
facilitated, 485, 485f, 485t, 486–487, 488f
of bilirubin, 331
of glucose. *See* Glucose transporters
insulin affecting, 491
net, 485f
passive, 485f, 485t, 486f
in red cell membrane
hormones in regulation of, 487
“Ping-Pong” model of, 487, 488f
simple, 485f, 485t
- Digestion, 538–541
- Digitalis, 491, 657, 657f
Ca²⁺-Na⁺ exchanger in action of, 656–657
Na⁺-K⁺-ATPase affected by, 491
- Dihydrobiopterin, defect in synthesis of, 304
- Dihydrobiopterin reductase, defect in, 304
- Dihydrofolate/dihydrofolate reductase, methotrexate affecting, 353–354, 559
- Dihydrolipoamide dehydrogenase, 311t
- Dihydrolipoyl dehydrogenase, 121, 173, 173f
- Dihydrolipoyl transacetylase, 172, 173f
- Dihydropyridine receptor, 654, 656
- Dihydrotestosterone, 505, 506f
- Dihydroxyacetone, 155f
- Dihydroxyacetone phosphate, in glycolysis, 246, 247f
- 24,25-Dihydroxyvitamin D₃ (24-hydroxycalcidiol) in vitamin D metabolism, 552
- Diiodotyrosine, 510
- Dilated cardiomyopathy, 659
- Dimercaprol, 132, 132f
- Dimeric proteins, 41
- Dimers
Cro protein, 434, 435f
histone, 373
lambda repressor (cI) protein, 434, 435f
- Dimethylallyl diphosphate, in cholesterol, 268f
synthesis, 267
- Dimethylaminoadenine, 342f
- 2,4-Dinitrophenol, 132
- Dinucleotide, 344, 345
- Dioxygenases, 123
- Dipalmitoyl lecithin, 216
- Dipeptidases, 539
- Diphosphates, nucleoside, 340, 341f
- Diphosphatidylglycerol. *See* Cardiolipin
- Diphtheria toxin, 426–427, 490
- Dipoles, water forming, 6–7, 7f
- Direct carcinogen, 725f
- Disaccharidase deficiencies, 599
- Disaccharidases, 538
- Disaccharides, 153, 156, 157f, 157t. *See also* specific type
- Disassociation, 622
of four-helix bundle, 623
- Disease. *See also* Biochemical case histories; specific diseases
biochemical basis of, 3–4
conformational, 619t
Human Genome Project and, 3–4
- Dislocation, 619
- D isomerism, 153, 154f
- Displacement reactions
double, 84
sequential (single), 84
- Disposable “dipstick” strips, 596
- Dissociation constant, 10
Michaelis constant (K_m) and, 79
in pH calculation, 10
of weak acids, 10
- Dissociation of water, 9–10
- Distal histidine (histidine E7) in oxygen binding, 52
- Disulfide bonds, in chemokines, 702, 702f
- DIT. *See* Diiodotyrosine
- DIT:MIT ratio, 510
- Diurnal variation, in cholesterol synthesis, 270
- Divalent metal transporter, 673
- Diversity
antibody, 684
combinatorial, 684
junctional, 684
- Dixon plot, 83, 83f
- D-Lyxose, 155f
- D-Mannosamine, 156
- D-Mannose, 154f, 155t
- DMT. *See* Divalent metal transporter
- DNA, 370–392, 387f
ADP-ribosylation for, 556
antibody diversity in rearrangements of, 380–381
base excision-repair of, 389, 390f, 390t
base pairing in, 8, 360, 361f
matching of for renaturation, 361–362
recombinant DNA technology and, 451–468
blunt-ended, 452, 453
in chromatin, 372f, 373t, 374–376, 374f
chromosomal, 372f, 375t, 376f
coding regions of, 376, 376f
complementarity of, 362–363, 362f, 455
damage to, 390, 390f, 390t
repair of, 389–390, 390t
double-strand break repair of, 389–390, 391f
double-stranded, 360–361, 362–363, 362f
genetic information contained in, 359–362
grooves in, 361f, 362
integrity monitoring, 390–392
ligases, 385
mismatch repair of, 389, 389t, 390f, 390t
mitochondrial, 378–379, 378f, 378t
mutations in, 370–371, 379–381. *See also* Mutations
in nucleosomes, 371–373, 371f, 373, 374f
nucleotide excision-repair of, 389, 390f, 390t
recombinant. *See* Recombinant DNA/
recombinant DNA technology
relationship to mRNA, 376f
relaxed form of, 362
renaturation of, base pair matching and, 361–362
repair of, 389–390, 390t, 620
repetitive-sequence, 377
replication/synthesis of, 362–363, 363f, 381–392, 381t, 382f, 388t
DNA polymerase complex in, 382t
initiation of, 384f
origin of, 381–382
polarity, 386
reconstitution of chromatin structure and, 387–388
repair during, 389–390, 390t

- DNA, replication/synthesis of (*Cont.*):
 replication bubble formation and, 386–387, 386f, 387f
 replication fork formation and, 382f, 383
 ribonucleoside diphosphate reduction and, 352
 RNA primer in, 381t, 382f, 383
 semiconservative nature of, 363, 363f
 semidiscontinuous, 382f, 385f, 386
 in S phase of cell cycle, 388–389, 388f
 in RNA synthesis, 395–398
 sequencing of, 458f, 464
 stabilization of, 8
 structure of, 359–362, 360f, 361f
 denaturation in analysis of, 361
 double-helical, 8, 360–361, 361f
 supercoiled, 362, 387, 387f
 transcription of, 362–363
 transposition of, 380
 unique-sequence (nonrepetitive), 377
 unwinding, 398
- DNA binding motifs and transcription factors, 444–445, 444t
- DNA damage
 by environmental agents, 724
 by radiant energy, 724t
- DNA-dependent protein kinase, 390
- DNA-dependent RNA polymerases, 395–396
- DNA elements, combinations of, 443f
- DNA elements, gene expression affected by, 438
- DNA fingerprinting, 469
- DNA footprinting, 469
- DNA helicase, 382f
- DNA lesions, 761
- DNA ligase and recombinant DNA technology, 452–454, 453t, 454f
- DNA-PK. *See* DNA-dependent protein kinase
- DNA polymerases, 381, 382f, 383, 459f
 prokaryotic and eukaryotic, 383t
 in recombinant DNA technology, 453t
- DNA primase, 382f
- DNA-protein interactions, bacteriophage lambda
 as paradigm for, 433–437, 433f, 436f
- DNA regulatory elements, 442f
- DNase (deoxyribonuclease)/DNase I, 368
 active chromatin and, 373
 in recombinant DNA technology, 453t
- DNA sequences amplification and protein sequencing, 30
- DNA topoisomerases, 362, 386, 387f
- DNA transfection, endocytosis in, 492
- DNA viruses, 725
- dNDPs. *See* Deoxyribonucleoside diphosphates
- Docking, 621
 in nuclear import, 612
- Docking programs, molecular, 44
- Docking protein, 621, 622f
- Docosaheptaenoic acid (DHA), 214, 239
- Dolichol, 219, 220f, 575
 in cholesterol synthesis, 268f, 269
 structure of, 575
- Dolichol-P-P-GlcNAc (Dol-P-P-GlcNAc), 575f
- Dolichol-P-P-oligosaccharide
 pathway of biosynthesis, 576f
 structure of, 575f
- Dolichol pyrophosphate-oligosaccharide (Dol-P-P-oligosaccharide), 575–576
- Domains. *See also* specific type
 albumin, 671
 chromatin, 372f, 373
 DNA binding and transcription activation, 447f
 protein, 40
- Dopa decarboxylase, 317, 320f
 in catecholamine biosynthesis, 509–510
- Dopamine. *See also* Catecholamines
 biosynthesis of, 509, 509f
 synthesis of, 317, 320f
- Dopamine β -hydroxylase (DBH), 561
 in catecholamine biosynthesis, 510
- Double displacement reactions, 84
- Double helix, of DNA structure, 8, 360–361, 361f
- Double reciprocal plot and inhibitor evaluation, 82
- Double-stranded DNA, 360–361, 371, 396. *See also* DNA
- D-Ribose, 155f, 155t, 340, 344f
- D-Ribulose, 155f, 155t
- Drosha-DGCR8 nuclease, 409
- Drug detoxification/interactions, cytochromes
 P450 and, 123–124, 123f, 124f
- Drug development
 enzyme kinetics, mechanism, and inhibition in, 85
 RNA targets for, 368
- Drug discovery, enzyme assays suitable for “high-throughput” screening in, 66–67
- Drug metabolism, in vivo, 85
- Drug resistance, 448
- Drugs as enzyme inhibitors, 85
- Dry chemistry dipsticks, 596
- dsDNA. *See* Double-stranded DNA
- D-Sedoheptulose, 155f
- DTPA (diethylenetriaminepentaacetate), as preventive antioxidant, 220
- Dubin-Johnson syndrome, 333
- Duchenne muscular dystrophy, 463, 655
- Duodenal cytochrome b (Dcytb), 673
- D-Xylose, 155f, 155t
- D-Xylulose, 155f
- Dynamin, in absorptive pinocytosis, 493
- Dysbetalipoproteinemia, familial, 275t
- Dyslipoproteinemias, 275–276, 275t
- Dystrophin, 647, 655
- E**
- E0. *See* Redox (oxidation-reduction) potential
- Eact. *See* Activation energy
- E-cadherin, 736
- ECF. *See* Extracellular fluid
- ECM. *See* Extracellular matrix
- E. coli* bacteriophage P1-based (PAC) vector, 455
- E. coli*, lactose metabolism and operon hypothesis in, 430–433, 430f
- EcoRI*, 452, 452t, 454f
- EcoRII*, 452t
- E cyclins, 388–389, 388f, 388t
- Edema
 in kwashiorkor, 543
 plasma protein concentration and, 669
 in thiamin deficiency, 555
- Edematous. *See* Kwashiorkor
- Edman reaction, for peptide/protein sequencing, 29–30, 30f
- Edman reagent (phenylisothiocyanate), in protein sequencing, 30, 30f
- EDRF. *See* Endothelium-derived relaxing factor
- EDTA, as preventive antioxidant, 220
- EFA. *See* Essential fatty acids
- Effectors, 733
- Egg white, uncooked, biotin deficiency caused by, 560
- Ehlers–Danlos syndrome, 47, 282, 627, 630, 631t
- Eicosanoids, 213, 239, 241f, 706
- Eicosapentaenoic acid (EPA), 214, 238f
- eIF-4E complex, in protein synthesis, 421–422
- eIFs, in protein synthesis, 419
- Elaicid acid, 213, 213t, 215f
- Elastase, in digestion, 539
- Elastin, 631–632
- Electrogenic effect, 491
- Electron carriers, flavin coenzymes as, 556
- Electron flow, through respiratory chain, 127, 128f
- Electron movement, in active transport, 490
- Electron-transferring flavoprotein, 121, 225
- Electrophiles, 9
- Electrophoresis
 for plasma protein analysis, 669
 polyacrylamide, for protein/peptide purification, 28, 28f
 two-dimensional, protein expression and, 33
- Electrospray ionization, 31, 32f
 in mass spectrometry, 33
- Electrostatic bonds/interactions, 8. *See also* Salt (electrostatic) bonds
- ELISAs. *See* Enzyme-linked immunoassays
- Elongase, 236, 237f
 in polyunsaturated fatty acid synthesis, 239, 239f
- Elongation
 in protein synthesis, 423f
 in RNA synthesis, 398
- Elongation arrest, 614
- Elongation chain
 in fatty acid synthesis, 236, 237f
 in transcription cycle, 396f, 398
- Elongation factors, in protein synthesis, 421, 423f
 elongation factor 2, 422, 423f
 elongation factor EF1A, 421, 423f
- Emaciation, 140
- Emtricitabine, 85
- Emulsions, amphipathic lipids forming, 220–221, 221f
- Encephalopathies
 hyperbilirubinemia causing, 332
 from inherited mitochondrial defects, 127
 spongiform, 45
 Wernicke, 556
- ENCODE Project, 102
- Endergonic reaction, 114–115
 coupling and, 114–115
 ATP in, 115
- Endocrine system. *See also* Hormones
 diversity of, 498–517
 neural regulation of, 498
- Endocytosis, 477, 492–493, 492f
 receptor-mediated, 492f, 493
- Endoglycosidases F, 571
- Endonucleases, 368, 454
 restriction, 368, 451–454, 452t
 in recombinant DNA technology, 452t, 453t
- Endopeptidases, 539
- Endoplasmic reticulum (ER), 425, 576–577.
See also Estrogens

- accumulation of misfolded proteins in, 618–620
- acylglycerol synthesis and, 144*f*, 145
- fatty acid chain elongation in, 236, 237*f*
- rough
- in protein sorting, 614, 615*f*, 619*f*
 - protein synthesis and, 425
 - routes of protein insertion into, 615*f*, 616–618
- signal hypothesis of polyribosome binding to, 609*f*, 614–616, 614*t*
- Endoplasmic reticulum-associated degradation (ERAD) of misfolded proteins, 618–620, 620*f*
- Endosymbiosis, 760
- Endothelial cells, 579
- in clotting and thrombosis, 720, 721*t*
- Endothelium-derived relaxing factor, 660. *See also* Nitric oxide
- Energy
- activation, 74–75
 - free. *See* Free energy
 - nutritional requirement for, 541–542
 - transduction in membranes, 477
- Energy balance, 541–543, 542*f*
- Energy capture, 115–116
- Energy expenditure, 541–542, 542*f*
- Energy transfer, 116
- Enhancer-binding proteins, 440
- Enhancer insertion, 726, 726*t*
- Enhancer response element, 440*f*
- Enhancers/enhancer elements, 439–441
- Enhancers, properties of, 441*t*
- Enolase, in glycolysis, 170*f*, 171
- Entactin, 634
- Enterocytes, iron absorption in, 673
- Enterohepatic circulation, 274
- lipid absorption and, 539
- Enterohepatic urobilinogen cycle, 332
- Enteropeptidase, 539
- Enthalpy, 114
- Entrez Gene, 102
- Entropy, 114
- Enzymatic mechanisms and reactive oxygen species (ROS), 762
- Enzyme activation coefficient, 595
- Enzyme-catalyzed oxidation of organic molecules by molecular oxygen, 758
- Enzyme function initiative, unknown protein identification, 104–105
- Enzyme induction, 587
- cytochrome P450 and, 330
 - in gluconeogenesis regulation, 187–188, 188*t*
- Enzyme inhibitors, drugs as, 85
- Enzyme-linked immunoassays, 67
- Enzymes, 9
- active sites of, 62–63
 - analysis aiding diagnosis, 68–69
 - myocardial infarction, 68–69
 - assay of, 67
 - branching, in glycogen biosynthesis, 178, 178*f*
 - catalytic activity of. *See also* Catalysis/catalytic reactions (enzymatic)
 - detection facilitated by, 66–68
 - kinetics of, 77. *See also* Kinetics (enzyme)
 - classification of, 61, 61*f*
 - control networks and, 95–96
 - debranching
 - absence of, 179*t*
 - in glycogenolysis, 178, 178*f* - degradation of, control of, 90
 - in disease diagnosis/prognosis, 68–69
 - in DNA repair, 389, 390*t*
 - in drug development, 85
 - regulation of, 146*f*
 - specificity of, 61 - hydrolysis rate affected by, 9
 - isosteric, 91
 - isozymes and, 66
 - kinetics of, 77. *See also* Kinetics (enzyme)
 - mechanisms of action of, 60–71
 - membranes in localization of, 477
 - metal-activated, 62
 - of neutrophils, 703, 704*t*
 - plasma, diagnostic significance of, 68–69
 - quantity of, catalytic capacity affected by, 89–90
 - recombinant DNA technology in study of, 70
 - regulation of, 87–96
 - regulatory, 144, 146*f*
 - restriction. *See* Restriction endonucleases/enzymes
 - specificity of, 61
 - substrates affecting conformation of, 64
- Enzyme-substrate (ES) complex, 62, 78, 80, 81
- Enzymology, single molecule, 66, 67*f*
- Enzymopathy, 694
- Eosinophils, 700, 703
- in parasite entrapment, 705–706
- EPA. *See* Eicosapentaenoic acid
- Epidemiology
- bioinformatic analysis on, 101
 - definition of, 100
- Epidermal growth factor, receptor for, 43*f*
- Epidermis, 757*t*
- Epidermolysis bullosa, 631
- Epigenetic mechanisms
- in cancer, 735–736
 - in control of gene transcription, 438–439
 - factors involved in, 735*f*
- Epigenetic signals, transmission and propagation of, 440*f*
- Epimerases, 636
- in galactose metabolism, 203, 203*f*
 - in pentose phosphate pathway, 198, 199*f*
- Epimers, 154, 154*f*
- Epinephrine, 509. *See also* Catecholamines
- biosynthesis of, 509*f*, 510
 - blood glucose affected by, 193
 - in gluconeogenesis regulation, 188
 - in lipogenesis regulation, 237
 - synthesis of, 317, 320*f*
- Epithelial mesenchymal transition, 738
- Epitope (antigenic determinant), 39
- EPO (human erythropoietin), 692
- Epoxide hydrolase, 588, 588*f*
- Epoxides, 588
- Epstein-Barr virus, 700
- Equilibrium constant, 77
- in enzymatic catalysis, 77
 - free energy changes and, 75
- Ercalcitriol, 552
- Ergocalciferol (vitamin D₂), 552
- Ergosterol, 219, 219*f*
- Ergothioneine, 315, 316*f*
- Erlotinib, 740
- Erythrocyte aminotransferases, in vitamin B₆ status assessment, 557–558
- Erythrocytes
- 2,3-bisphosphoglycerate pathway in, 172, 172*f*, 691
 - glucose as metabolic necessity for, 146–147
 - glycolysis in, 172, 172*f*, 691
 - hemoglobin S “sticky patch” affecting, 58
 - hemolysis and pentose phosphate pathway/glutathione peroxidase, 200, 200*f*
 - metabolism of, 150*t*
- Erythrocyte transketolase activation, in thiamin nutritional status assessment, 556
- Erythroid ALA synthase (ALAS2), 326–327
- in porphyria, 328*t*
- Erythropoiesis, iron-deficient, 678
- Erythropoietin and red blood cell production, 692
- Erythropoietin/recombinant erythropoietin (epoetin alfa/EPO), 672*t*
- hepcidin regulation, 677
- Escherichia coli* bacteriophage P1-based (PAC) vector, 455
- Escherichia coli*, lactose metabolism in, operon hypothesis and, 430–433, 430*f*
- ES complex. *See* Enzyme-substrate (ES) complex
- E (exit) site, in protein synthesis, 422, 423*f*
- Essential amino acids. *See* Nutritionally essential amino acids
- Essential fatty acids, 232, 238, 238*f*, 239
- abnormal metabolism of, 241
 - deficiency of, 239
 - prostaglandin production and, 239
- Essential fructosuria, 196, 205
- Essential pentosuria, 196, 205
- Estrogens
- on amino acid transport, 487
 - biosynthesis of, 508*f*
 - hydroxylation steps in, 505
 - by peripheral aromatization of androgens, 505
- Estrone, 505
- Ethanol
- fatty liver and, 261
 - iron absorption and, 541
 - transferrin glycosylation with chronic abuse of, 674
- Ether lipids, biosynthesis of, 248*f*
- Ethylenediaminetetraacetate (EDTA), as preventive antioxidant, 220
- Euchromatin, 374
- Eukaryotic cell cycle, versatility of, 95–96, 95*f*
- Eukaryotic cell transcription, gene expression in, 447*t*
- Eukaryotic DNA, 439–441
- Eukaryotic gene expression, 433–437, 433*f*. *See also* Gene expression
- DNA-protein interactions in, bacteriophage lambda as paradigm for, 433–437
- Eukaryotic mRNA, structure of, 449*f*
- Eukaryotic promoters, in transcription, 400–403
- Eukaryotic transcription complex, 403–405
- Evolution and lifespan, 766
- Exchange diffusion systems, 133

- Exchange transporters, 133–135, 135f
Excitation-response coupling, membranes in, 477
Ergogenic reaction, 114–115
 coupling and, 114–115
 ATP in, 115
Exit (E) site, in protein synthesis, 422, 423f
Exocytosis, 477, 492, 493, 493f, 495f
Exocytotic (secretory) pathway, 608
Exome sequencing, 99
Exons, 376, 413
 interruptions in. *See* Introns
 (intervening sequences)
Exonucleases, 368, 451
 in recombinant DNA technology, 453t
Exopeptidases, 539
Exosomes, 494
Exportins, 612
Extra arm, of tRNA, 366, 367f
Extracellular environment, membranes in
 maintenance of, 478, 478t
Extracellular fluid, 478, 478t
Extracellular lysosomal enzymes, 581
Extracellular matrix. *See also* Matrix; specific
 components
 aging process, 627
 connective tissue, 627
 fibronectin, 633–634
 proteoglycans, 627
 role in metastasis, 736
 structural proteins, 627
Extramitochondrial system, fatty acid synthesis
 in, 232
Extrinsic pathway of blood coagulation, 712–713,
 712f, 733
Eye, fructose and sorbitol in, diabetic cataract
 and, 205
Ezetimibe, for hypercholesterolemia, 275
- F**
Fab region, 681
Fabry disease, 251t
Facilitated diffusion/transport system, 485f, 485t,
 486–487, 488f
 for bilirubin, 331
 for glucose. *See also* Glucose transporters
 insulin affecting, 491
 hormones in regulation of, 487
 “Ping-Pong” model of, 487, 488f
 and transporters, 486–487
F-Actin, 650, 651
Factor I (fibrinogen), 670f, 714t, 715
 conversion to fibrin, 715–717
Factor II (prothrombin), 714, 714t
 coumarin drugs affecting, 717
Factor III (tissue factor), 712, 712f, 713t, 714t
Factor IV. *See* Calcium
Factor IX (antihemophilic factor B/Christmas
 factor/plasma thromboplastin component),
 712f, 713, 713f, 713t, 714t
 coumarin drugs affecting, 717
 deficiency of, 718
Factor V (proaccelerin/labile factor/accelerator
 globulin), 712f, 713t, 714, 714t
Factor VII (proconvertin/serum prothrombin
 conversion accelerator/cothromboplastin),
 712, 712f, 713t, 714t
 coumarin drugs affecting, 717
Factor VIII (antihemophilic factor A/globulin),
 712f, 713t, 714, 714t
 deficiency of, 718
Factor VIII concentrates, recombinant DNA
 technology in production of, 718
Factor V Leiden, 717
Factor X (Stuart-Prower factor), 712f, 713f, 713t,
 714t
 activation of, 712f, 713–714
 coumarin drugs affecting, 717
Factor XI (plasma thromboplastin antecedent),
 712f, 713f, 713t, 714t
 deficiency of, 718
Factor XII (Hageman factor), 712f, 713, 713f, 713t,
 714t
Factor XIII (fibrin stabilizing factor/fibrinolygase),
 712f, 713t, 714t, 715
Factor X, prothrombin to thrombin activation by,
 712f, 713, 714–715
Facultative heterochromatin, 374
FAD. *See* Flavin adenine dinucleotide
FADH₂, fatty acid oxidation yielding, 224f, 225
Familial amyloidosis, 680
Familial hypertrophic cardiomyopathy, 658–659,
 659f
Farber disease, 251t
Farnesoid X receptor in bile acid synthesis
 regulation, 274
Farnesyl diphosphate, in cholesterol/
 polyisoprenoid synthesis, 267, 268f,
 269–270
Fast atom bombardment (FAB), in mass
 spectrometry, 31
Fasting state, metabolic fuels in, 140, 148–149,
 148t, 149f
Fatal infantile mitochondrial myopathy and renal
 dysfunction, 135
Fatigue (muscle), 168
Fats, 212. *See also* Lipids
 metabolism of, 140–141, 140f, 141f, 143
Fat tissue. *See* Adipose tissue
Fatty acid-binding protein, 223, 255
Fatty acid chains, elongation of, 236, 237f
Fatty acid elongase system, 236, 237f
 in polyunsaturated fatty acid synthesis, 239,
 239f
Fatty acid oxidase, 225
Fatty acids, 3, 212–215
 activation of, 224, 224f
 anti-inflammatory, 214–215
 calcium absorption affected by, 541
 eicosanoids formed from, 239, 241f
 essential, 232, 238, 238f, 239
 abnormal metabolism of, 241
 deficiency of, 239
 prostaglandin production and, 239
 free. *See* Free fatty acids
 interconvertibility of, 145
 in membranes, 479
 metabolism of, 140–141, 141f
 nomenclature of, 212, 212f
 oxidation of, 224–226. *See also* Ketogenesis
 acetyl-CoA release and, 141, 141f, 224–226,
 224f, 225f
 clinical aspects of, 231
 hypoglycemia caused by impairment of, 231
 physical/physiologic properties of, 213–214
 saturated, 213, 213t
 synthesis of, 232–236, 233f, 234f. *See also*
 Lipogenesis
 carbohydrate metabolism and, 140
 citric acid cycle in, 165–168, 166f
 extramitochondrial, 234
 in mitochondria, 224, 224f
 trans, 213, 239
 transport of, carnitine in, 224, 224f
 triacylglycerols (triglycerides) as storage form
 of, 215, 216f
 unesterified (free). *See* Free fatty acids
 unsaturated, 213. *See also* Unsaturated fatty
 acids
Fatty acid synthase, 80, 233–234
Fatty acid synthase complex, 233–234, 233f, 234f,
 238
Fatty acid synthesis, carbohydrates in, 145–146
Fatty acid-transport protein, membrane, 255
Fatty liver
 alcoholism and, 261
 nonalcoholic fatty liver disease, 260
 nonalcoholic hepatic steatosis, 260
 of pregnancy, 231
 triacylglycerol metabolism imbalance and,
 260–261
Favism, 204
Fc fragment, 684
Fe. *See* Iron
Fed state, metabolic fuels in, 140, 147–148,
 148t
Feedback inhibition in allosteric regulation, 90f,
 91, 146f
Feedback regulation in allosteric regulation, 91,
 145
Feedback regulation of circulating thrombin
 levels, 717
Ferric iron, 330
 in methemoglobinemia, 57
Ferritin, 541, 673
 protein synthesis affected by, 425
Ferritin receptor, 674
Ferrochelatase (heme synthase), 326, 328t, 329
 in porphyria, 328t
Ferroporphyrin, 541, 673
Ferrous iron
 incorporation of into protoporphyrin, 326
 in oxygen transport, 52–53
Fertilization, 579
Fetal hemoglobin, P50 of, 55
FFA. *See* Free fatty acids
FGFR3 (fibroblast growth factor receptor 3), 645
Fibrin
 deposits, 712
 dissolution by plasmin, 718, 718f
 fibrillin-1, 632
 fibrillin-2, 632
 formation of, 712f, 715
 thrombin in, 715–717
 mesh formation, 711
 in thrombi, 712
Fibrinogen (factor I), 668, 670f, 714t, 715
 conversion to fibrin, 715–717
Fibrinolygase (factor XIII), 712f, 713t, 714t, 715
Fibrinolysis, 721t
Fibrinopeptides A and B, 716f
Fibroblast growth factor receptors, 645

- Fibroblasts, 577
- Fibronectin, 630, 633
cell interacting, 633*f*
schematic representation of, 633*f*
- Fibronectin receptor, 633
- Fibrous proteins, 37, 46
- Figlu. *See* Formiminoglutamate
- Fingerprinting, DNA, 469
- FISH. *See* Fluorescence in situ hybridization
- Fish-eye disease, 275*t*
- Flame photometry, 594
- Flavin adenine dinucleotide, 120, 344*t*, 556, 556*f*
in citric acid cycle, 164
- Flavin mononucleotide, 62, 120, 556, 556*f*
- Flavoproteins
electron-transferring, 121
as oxidases, 120, 123*f*, 124*f*
in respiratory chain complexes, 121, 127–128
- Flip-flop, phospholipid, membrane asymmetry and, 482
- Flippases, 482
- Fluidity, membrane, 483–484
- Fluid mosaic model, 483–484, 483*f*
- Fluid-phase pinocytosis, 492*f*, 493, 493*f*
- Fluoroacetate, 162
- Fluorescence in situ hybridization, 459
- Fluorescence, of porphyrins, 327–329, 328*f*
- Fluorescence spectrophotometry, 593, 594*f*
- Fluoride, 562*t*
in glycolysis, 170*f*
- 1-Fluoro-2,4-dinitrobenzene (Sanger reagent) for polypeptide sequencing, 29
- Fluoroacetate, 163*f*
- 5-Fluorouracil, 344*f*, 354
- Fluvastatin, 275
- Flux-generating reaction, 145
- FMN. *See* Flavin mononucleotide
- Folate. *See* Folic acid
- Folate trap, 558*f*
- Folding
code, unknown protein identification, 103
formation after denaturation, 45
polar and charged group positioning and, 8
protein, 26*f*, 44–45
- Folic acid, 546, 559–560, 559*f*
coenzymes derived from, 62
deficiency of, 299
forms of in diet, 559–560
inhibitors of metabolism of, 559
supplemental, 560
- Footprinting, DNA, 469
- Forbes disease, 179*t*
- Forensic medicine
restriction fragment length polymorphisms in, 463
variable numbers of tandemly repeated units in, 464
- Forkhead transcription factor, 43*f*
- Formic acid, pK/pK_a value of, 13*t*
- Formiminoglutamate, 299, 302*f*
- Formyl-tetrahydrofolate, 559
- Four-helix bundle, 623
- Fourier synthesis, 43
- FPA/FPB. *See* Fibrinopeptides A and B
- Fractions, 26, 27*f*
- Frameshift mutations, 417–418
- Framework regions, 683
- Free amino acids, absorption of, 539, 541
- Free energy
changes in, 114
chemical reaction direction and, 74
coupling and, 114, 114*f*
enzymes affecting, 77
equilibrium state and, 74
redox potential and, 119–120, 120*t*
transition states and, 74–75
of hydrolysis of ATP, 115–116, 116*t*
- Free fatty acids, 223, 254, 254*t*
in fatty liver, 260
glucose metabolism affecting, 262
insulin affecting, 262
ketogenesis regulation and, 229–230, 229*f*
lipogenesis affected by, 236, 237*f*
metabolism of, 255
starvation and, 148*t*, 149, 149*f*
- Free polyribosomes, protein synthesis on, 607–608, 618. *See also* Polyribosomes
- Free radicals, 564–568, 760. *See also* Antioxidants
causing damage, 564–565, 565*f*
disease causing, 564
in kwashiorkor, 543
lipid peroxidation producing, 219–220, 220*f*
and mitochondrial theory of aging, 760
multiple sources of oxygen, 566–567, 566*f*
in oxygen toxicity, 124
protection mechanisms against damage, 567, 567*f*
as self-perpetuating chain reactions, 564
- Free radical theory of aging, 760
- Fructokinase, 202, 202*f*
deficiency of, 205
- Fructose
absorption of, 538, 538*f*
in diabetic cataract, 205
glycemic index of, 538
hepatic
hypertriacylglycerolemia/
hypercholesterolemia/hyperuricemia and, 205
metabolism affected by, 202–203, 202*f*
iron absorption affected by, 541
metabolism of, 202*f*
defects in, 205
pyranose and furanose forms of, 154*f*
- Fructose 1,6-bisphosphatase, 205
- Fructose-1,6-bisphosphate, 187
in gluconeogenesis, 186*f*, 198
in glycolysis, 170, 170*f*
- Fructose-2,6-bisphosphatase, 189, 190*f*
in covalent catalysis, 65
- Fructose-2,6-bisphosphate, 189, 190*f*
- Fructose-6-phosphate, 187
free energy of hydrolysis of, 116*t*
in gluconeogenesis, 186*f*, 198
in glycolysis, 170, 170*f*
- Fructose intolerance, hereditary, 205
- Fructosuria, essential, 196, 205
- Fucosyl (Fuc) transferase, 697
- Fuels, metabolic. *See* Metabolic fuels
- Fumarase, 163*f*, 164
- Fumarate, 163*f*, 164
in tyrosine catabolism, 305*f*
in urea synthesis, 294
- Fumarate hydratase. *See* Fumarase
- Fumarylacetoacetate hydrolase, 300*t*
defect in tyrosinemia, 304
- Fumarylacetoacetate, in tyrosine catabolism, 304, 305*f*
- Functional groups
amino acid properties affected by, 20–22
medium affecting pK of, 13
physiologic significance of, 11–12
- Furanose ring structures, 154, 154*f*
- Furin, 623
- Fusion of vesicles, 621
- Fusion proteins, recombinant, in enzyme study, 70
- FXR. *See* Farnesoid X receptor
- G**
- G-Actin, 649
- GAGs. *See* Glycosaminoglycans
- GAL1 enhancer, 446
- Galactokinase, 203, 203*f*
inherited defects in, 205
- Galactosamine, 203
- Galactose, 152
absorption of, 538, 538*f*
D-galactose, 154*f*, 155*t*
glycemic index of, 538
metabolism of, 203, 203*f*
enzyme deficiencies and, 205
- Galactose 1-phosphate uridylyl transferase, 203, 203*f*
- Galactosemia, 152, 196, 205
- Galactosidases, 571
- Galactoside, 155
- Galactosylceramide, 218, 218*f*, 250, 251*t*, 479
- GalCer. *See* Galactosylceramide
- Gal-Gal-Xyl-Ser trisaccharide, 573
- Gallstones, 537
cholesterol, 267
- GalNAc-Ser[Thr], 573
- GalNAc transferase, 698
- Gal transferase, 698
- Gangliosides, 218
amino sugars in, 156, 204*f*
sialic acids in, 156
synthesis of, 250, 251*f*
- Gap junctions, 494, 494*f*
schematic diagram of, 494*f*
- Gastric lipase, 539
- Gastroenteropathy, protein-losing, 671
- Gastrointestinal function, markers of, 599
- Gated ion channels, 489
- Gaucher disease, 251*t*
- GDH. *See* Glutamate dehydrogenase/L-glutamate dehydrogenase
- GDP, 615. *See also* Guanosine diphosphate
- Gefitinib, 740
- GEFs. *See* Guanine nucleotide exchange factors
- Gel electrophoresis, polyacrylamide, for protein/peptide purification, 28–29, 28*f*, 29*f*
- Geleophysic dysplasia, 632
- Gel filtration, for protein/peptide purification, 28*f*
- Gemfibrozil, 275
- GenBank, UniProt, and Protein Database (PDB), 101
- Gene. *See* Genes; Genome
- Gene amplification, 726*t*, 727
- Gene array chips, protein expression and, 33
- Gene conversion, 380

- Gene disruption/knockout, targeted, 464
- Gene expression
 constitutive, 430
 miRNA and siRNA inhibition of, 368
 in pyrimidine nucleotide synthesis, regulation of, 354
 regulation of, 428–449
 eukaryotic transcription and, 433–437
 negative vs. positive, 429, 429*t*
 prokaryotic vs. eukaryotic, 447–449
 retinoic acid in, 547
 temporal responses and, 429–437, 429*f*
- Gene mapping, 376
- General acid/base catalysis, 63
- Genes
 alteration of, 379–381, 380*f*
 housekeeping, 430
 immunoglobulin, DNA rearrangement and, 380–381
 inducible, 430
 knockout, 464–465
 previously unknown, 3
 processed, 380
 targeted disruption of, 464–465
- Genes encoding, 630
- Gene therapy, 3, 464, 625
 for urea biosynthesis defects, 296
- Genetic code, 359, 414, 414*t*
 features of, 415, 415*t*
- Genetic damage, causes of, 724
- Genetic diseases. *See also* specific diseases
 enzymes in diagnosis of, 70
 gene therapy for, 464
 recombinant DNA technology in diagnosis of, 460, 462*f*
- Gene transcription GeneCards database, 102.
See also Transcription
- Genevan system, for fatty acid nomenclature, 212
- Gene variations causing disease, 460
- Genome
 and medicines, in bioinformatics, 98–99
 redundancy in, 377–378
 removal of gene from (targeted gene disruption/knockout), 464–465
- Genomic instability of cancer cells, 731–732
- Genomic library, 455
- Genomic resources, 101–102
- Genomics, 98–99
 enables proteins, 30
 protein sequencing and, 30
- Genomics revolution, 98
- Genomic technology, 451–468. *See also*
 Recombinant DNA/recombinant DNA technology
- Geometric isomerism, of unsaturated fatty acids, 213, 215*f*
- Geranyl diphosphate, in cholesterol synthesis, 267, 268*f*
- γ -Glutamyl phosphate, 283
- γ -Glutamyltransferase, 586
- GGT. *See* γ -Glutamyltransferase
- Gibbs change in free energy, 113
- Gibbs free energy/Gibbs energy. *See* Free energy
- Gilbert syndrome, 333
- GlcCer. *See* Glucosylceramide
- GlcN. *See* Glucosamine
- GlcNAc phosphotransferase, 581
- GlcNAc residues, 571
- GlcNAc transferase V, 736
- Glibenclamide. *See* Glyburide
- Globin, 330
- Globular proteins, 37
- Globulins, 669
- Glomerular filtration, 634
- Glomerular membrane, 634
- Glomerular proteinuria, 597*t*
- Glomerulonephritis, 634
- Glucagon, 140, 179, 192
 in fasting state, 148
 in gluconeogenesis regulation, 188
 in lipogenesis regulation, 237, 237*f*
- Glucagon/insulin ratio, in ketogenesis regulation, 230
- Glucan (glucosan), 156
- Glucan transferase, in glycogenolysis, 177*f*, 178
- Glucocorticoids, 528. *See also* specific type
 blood glucose affected by, 192
 in lipolysis, 263, 263*f*
 regulation of gene expression by, 519*f*
 synthesis of, 504–505, 504*f*
 transported by corticosteroid-binding globulin, 516
- Glucogenic amino acids, 146
- Glucokinase, 188*t*, 753
 in blood glucose regulation, 191–192, 192*f*
 gene mutation of, 753*t*
 in glycogen biosynthesis, 176, 177*f*, 188*t*
 in glycolysis, 170, 170*f*, 188*t*
- Gluconeogenesis, 140, 143, 185–194, 186*f*
 blood glucose regulation and, 190–193, 191*f*, 192*f*
 citric acid cycle in, 164–165, 165*f*, 185–187, 186*f*
 energy cost of, 194
 in glycolysis, 169–171, 170*f*, 172*f*, 186*f*, 187–190
 regulation of, 172
 regulation of, 187–190, 188*t*, 190*f*
 allosteric modification in, 188–189
 covalent modification in, 188
 enzyme induction/repression in, 187–188, 188*t*
 fructose 2,6-bisphosphate in, 189, 190*f*
 substrate (futile) cycles in, 190
 thermodynamic barriers to glycolysis and, 185–187, 186*f*
- Gluconeogenic amino acid, 289, 290*f*
- Gluconolactone hydrolase, 198, 199*f*
- Glucosamine (GlcN), 156*f*, 203, 204*f*, 637
- Glucosan (glucan), 156
- Glucose, 152–160, 663
 absorption of, 538, 538*f*
 as amino sugar precursor, 203, 204*f*
 blood. *See* Glucose, blood
 epimers of, 159, 159*f*
 in extracellular and intracellular fluid, 478*t*
 furanose forms of, 154, 154*f*
 galactose conversion to, 203, 203*f*
 glycemic index of, 538
 in glycogen biosynthesis, 176, 177*f*
 insulin secretion and, 192
 interconvertibility of, 145–146
 isomers of, 153–154, 154*f*
 as metabolic necessity, 146
 permeability coefficient of, 481*f*
 pyranose forms of, 154, 154*f*
 renal threshold for, 193
 structure of, 153, 154*f*
 transport of, 190, 192*f*, 491, 492*f*, 538
 insulin affecting, 491
 uptake of, 148
- Glucose-1-phosphate
 free energy of hydrolysis of, 116*t*
 in gluconeogenesis, 186*f*, 187
- Glucose-6-phosphatase
 deficiency of, 179*t*, 355
 in gluconeogenesis, 188*t*
 in glycogenolysis, 178
- Glucose-6-phosphate, 178
 free energy of hydrolysis of, 116*t*
 in gluconeogenesis, 182, 186*f*
 in glycogen biosynthesis, 176, 177*f*
 in glycolysis, 170, 170*f*
- Glucose-6-phosphate dehydrogenase (G6PD), 693–694
 deficiency, 693*t*
 and hemolytic anemia, 693–694, 694*f*
 deficiency of, 196, 204–205
 in pentose phosphate pathway, 196, 197*f*, 198, 199*f*
- Glucose-alanine cycle, 191, 191*f*
- Glucose, blood
 ATP generated by, 169*t*, 173
 in fed state, 148
 free fatty acids and, 262
 insulin affecting, 192, 194
 normal, 176
 by pentose phosphate pathway, 140, 196, 197*f*, 199*f*, 200*f*
 red blood cells and, 691
 regulation of
 clinical aspects of, 193–194, 193*f*
 diet/gluconeogenesis/glycogenolysis in, 190–193, 191*f*, 192*f*
 glucagon in, 192
 glucokinase in, 191–192, 192*f*
 glycogen in, 178
 insulin in, 192
 limits of, 190
 metabolic and hormonal mechanisms in, 191, 192*t*
 starvation and, 148, 148*t*, 149*f*
- Glucose metabolism, 140, 141*f*, 169–171, 170*f*, 172*f*, 190, 191*f*. *See also* Gluconeogenesis; Glycolysis
- Glucose permease, 691*t*
- Glucose synthesis, fatty acids and, 145–146
- Glucose tolerance, 193*f*, 194
- Glucose transporters, 191, 191*t*, 691, 691*t*
 in blood glucose regulation, 191, 191*t*, 192, 262
 insulin affecting, 491
- Glucoside, 155
- Glucosuria, 193
- Glucosylceramide, 218, 250, 250*f*, 479
- Glucuronate/glucuronic acid, 200, 201*f*
 bilirubin conjugation with, 331–332, 331*f*
- Glucuronidation of bilirubin, 331–332, 331*f*, 586
- Glucuronides, 196, 200
- GLUT1 (Glucose transporter), 691, 691*t*
- GLUT 1–4. *See* Glucose transporters
- Glutamate, 165
 carboxylation of, vitamin K as cofactor for, 554–555

- catabolism of, 298*f*, 299
 in proline synthesis, 284, 284*f*
 synthesis of, 282–283, 283*f*
 transamination and, 289*f*, 290–291, 291*f*
 in urea biosynthesis, 289*f*, 290–291, 291*f*
- Glutamate aminotransferase, 291
- Glutamate/aspartate transporter, 134, 135*f*
- Glutamate dehydrogenase/L-glutamate dehydrogenase, 283, 283*f*
 in nitrogen metabolism, 291, 291*f*, 292*f*
- Glutamate- γ -semialdehyde, 19*t*, 284*f*
- Glutamic acid, 17*t*
- Glutaminase, in amino acid nitrogen catabolism, 292
- Glutaminase reaction, 292*f*
- Glutamine, 17*t*, 165, 289
 in amino acid nitrogen catabolism, 292
 catabolism of, 299, 299*f*
 synthesis of, 283, 283*f*, 292*f*
- Glutamine analogs, purine nucleotide synthesis affected by, 348, 350
- Glutamine synthetase/synthase, 283, 283*f*, 292, 292*f*
- Glutamyl amidotransferase, PRPP, regulation of, 350, 351, 351*f*
- Glutaric acid, pK/pK_a value of, 13*t*
- Glutathione, 23, 23*f*, 748, 762
 acetylphenylhydrazine effect on, 748*t*
- Glutathione peroxidase, 122, 200, 200*f*, 204
- Glutathione reductase, 748, 748*t*
 erythrocyte
 pentose phosphate pathway and, 200, 200*f*, 205
 riboflavin status and, 556
- Glutathione S-transferases, 70*f*, 586
- Glyburide, 231
- N-glycan chains, 615
- Glycation, 569
- Glycemic index, 156, 538
- Glyceraldehyde-3-phosphate
 in glycolysis, 170, 170*f*
 oxidation of, 170, 171*f*
- Glyceraldehyde-3-phosphate dehydrogenase, 695*t*
 in glycolysis, 170, 170*f*
- Glyceraldehyde (glycerose), D and L isomers of, 154*f*
- Glycerol, 215
 permeability coefficient of, 481*f*
 synthesis of, 187
- Glycerol-3-phosphate
 acylglycerol biosynthesis and, 246, 247*f*
 electron transfer via, 128
 free energy of hydrolysis of, 116*t*
 triacylglycerol esterification and, 261–262, 262*f*
- Glycerol-3-phosphate acyltransferase, 246, 247*f*
- Glycerol-3-phosphate dehydrogenase, 246, 247*f*
- Glycerol ether phospholipids, synthesis of, 248–249, 248*f*
- Glycerol kinase, 246, 247*f*, 261
- Glycerol moiety, of triacylglycerols, 140
- Glycerolphosphate acyltransferase, 127
- Glycerol phosphate pathway, 247*f*
- Glycerophosphate shuttle, 134, 134*f*
- Glycerophospholipids, 212
- Glycerose (glyceraldehyde), D and L isomers of, 154*f*
- Glycine, 16*t*, 315
 catabolism of, pyruvate formation and, 301, 302*f*
 in heme synthesis, 315, 325–327, 325*f*, 328*f*
 synthesis of, 283, 284*f*
- Glycine cleavage complex, 301
- Glycine hydroxymethyltransferase, 301, 302*f*
- Glycine N-methyl-transferase, 300*t*
- Glycine residues, 628
- Glycinuria, 301
- Glycobiology, 569
- Glycocalyx, 159, 218
- Glycochenodeoxycholic acid, synthesis of, 273*f*
- Glycocholic acid, synthesis of, 273*f*
- Glycoconjugates, 569
 glycans of, 581
- Glycoforms, 570
- Glycogen, 156, 159*f*
 branching in, 178
 in carbohydrate metabolism, 140, 141*f*, 187
 carbohydrate storage and, 177*t*, 178
 cyclic AMP in, 181*f*, 183*f*
 cyclic AMP role in regulating metabolism of, 179–180, 181*f*
 glycogen synthase and phosphorylase in, 182, 182*f*
 metabolism of. *See also* Glycogenesis;
 Glycogenolysis
 branching in, 178*f*
 clinical aspects of, 179*t*, 183
 muscle, 148, 177*t*, 178
 synthesis of, 148
- Glycogenesis, 142, 178, 178*f*
 regulation of
 cyclic AMP in, 180, 181*f*, 182–183, 183*f*
 enzymes in, 188*t*
 glycogen synthase and phosphorylase in, 182–183, 182*f*
- Glycogenin, 177, 177*f*
- Glycogenolysis, 143
 blood glucose regulation and, 190–193, 191*f*, 192*f*
 cyclic AMP-independent, 180
 cyclic AMP in regulation of, 181*f*, 182, 183*f*
 debranching enzymes in, 178, 178*f*
 glycogen synthase and phosphorylase in
 regulation of, 182–183, 182*f*
 pathway of, 176–178, 177*f*
- Glycogen phosphorylase, 177*f*, 178, 662, 663
 pyridoxal phosphate as cofactor for, 557
 regulation of, 179–180, 182–183, 183*f*
- Glycogen storage diseases, 152, 176, 179*t*, 183
- Glycogen synthase, in glycogen metabolism, 177, 177*f*, 187, 188*t*
 glycogen synthase a, 182, 182*f*
 glycogen synthase b, 182, 182*f*
 regulation of, 182, 182*f*
- Glycolipids, 212, 218, 218*f*, 569
 amino sugars in, 203, 204*f*
 galactose in synthesis of, 203, 203*f*
- Glycolipid storage diseases, 245
- Glycolysis, 116, 140, 141*f*, 168–175, 170*f*
 aerobic, 171
 anaerobic, 168, 169*f*, 170*f*, 171
 ATP generated by, 169*t*, 173
 clinical aspects of, 174
 in erythrocytes, 172, 172*f*
 glucose utilization/gluconeogenesis and, 169–172, 170*f*, 172*f*, 185–187, 186*f*. *See also* Gluconeogenesis
 pathway of, 169–171, 170*f*, 171*f*
 pyruvate oxidation and, 164, 166*f*, 169*t*, 172–174, 173*f*, 174*f*
 regulation of, 172
 enzymes in, 188*t*
 fructose 2,6-bisphosphate in, 189, 190*f*
 gluconeogenesis and, 172, 187–190, 188*t*, 190*f*
 at subcellular level, 144, 144*f*
 thermodynamic barriers to reversal of, 185–187
- Glycolytic enzymes, in muscle, 647–648
- Glycome, 569
- Glycomics, 3
- Glycophorins, 159, 573
 glycophorins A, B, and C, 695*t*, 696
- Glycoprotein glycosyltransferases, 574
- Glycoprotein IIb-IIIa, in platelet activation, 719*f*, 720
- Glycoprotein lysosomal hydrolases, genetic deficiencies of, 581, 581*t*
- Glycoprotein processing enzymes, 577*t*
- Glycoproteins, 37, 156, 156*f*, 204*f*, 502*f*, 569–582, 571*t*, 575, 669. *See also* Plasma proteins;
 specific type
 abnormalities in biosynthesis of, 580*t*
 amino sugars in, 156, 203, 204*f*
 asialoglycoprotein receptor in clearance of, 572
 carbohydrates in, 155*t*
 classes of, 573
 complex, 576
 diseases associated with abnormalities of, 580–581
 extracellular, absorptive pinocytosis of, 493
 in fertilization, 579
 functions of, 569, 570*t*
 galactose in synthesis of, 203, 203*f*
 glycosylphosphatidylinositol-anchored, 573
 high-mannose, 574
 high-resolution NMR spectroscopy, 570
 human glycoproteins, 571*t*
 hybrid, 574
 immunoglobulins as, 681
 linkage, anhydro nature of, 573
 membrane asymmetry and, 482
 N-linked, 573
 nucleotide sugars, 574
 oligosaccharide chains of, 569–570, 570*t*, 574
 O-linked, 574
 structure and function of, 571*t*
 sugars in, 574
 techniques for study of, 570–571
 asialoglycoprotein receptor in, 572
 glycosidases in, 571
 lectins in, 572
 in zona pellucida, 579
- Glycosaminoglycans, 156, 159*f*, 634–636, 634–640. *See also* specific type
 amino sugars in, 156
 functions of, 638*t*
 properties of, 637*t*
 structures of, 636*f*
- Glycosidases, 571
- Glycosides, 155–156
- N-glycosides, heterocyclic, 340

- N-glycosidic linkage, 573
 Glycosphingolipids, 212, 218, 218*f*, 250, 251*f*, 479, 624, 697
 Glycosylated hemoglobin (HbA_{1c}), 58–59
 Glycosylation, 569, 578
 congenital disorders of, 580*t*, 674
 cotranslational, 616
 in covalent modification, mass increases and, 31*t*
 N-glycosylation of glycoproteins, 576*t*, 577
 Glycosylphosphatidylinositol, 573, 623
 Glycosylphosphatidylinositol-anchored (GPI-anchored), 573
 GM₁ ganglioside, 218, 218*f*
 GM₃ ganglioside, 218
 GMP, 341*t*
 cyclic, 343*f*, 344*t*
 as second messenger, 343
 IMP conversion to, 348, 350*f*
 feedback-regulation of, 351, 351*f*
 PRPP glutamyl amidotransferase regulated by, 350, 351
 Golgi apparatus, 572, 576, 608
 appearing to collapse into ER, 623
 lumen of, 615
 in membrane synthesis, 608
 proteins destined for membrane of, 608, 615
 in protein sorting, 608, 608*f*
 retrograde transport from, 616, 618
 in VLDL formation, 256*f*
 Golgi apparatus in, 608
 Gonadal steroids, transport of, 517
 Gout/gouty arthritis, 354
 GPCRs. *See* G protein-coupled receptors
 G6PD (glucose-6-phosphate dehydrogenase), 693–694
 deficiency, 693*t*
 and hemolytic anemia, 693–694, 694*f*
 GPI. *See* Glycosylphosphatidylinositol
 GPIIb-IIIa, in platelet activation, 719*f*, 720
 GPI-linked proteins, 577–578, 577*t*
 G protein-coupled receptors, 521, 521*f*, 702
 G proteins, 522*t*
 classes and functions of, 522*t*
 Granules, 703
 Granulocytes, 700, 703, 706
 GRASP diagrams, 104, 105*f*
 Gratuitous inducers, 431
 Group transfer potential, 115
 of nucleoside triphosphates, 343, 344*t*
 Group transfer reactions, 9, 63
 Growth differentiation factor 15 (GDF15), 677
 Growth factors, polypeptide, 730*t*
 functions of, 730
 relationship with cancer, 730
 Growth hormone, amino acid transport affected by, 487
 Growth inhibitory factors, 730
 GSH. *See* Glutathione
 GSLs. *See* Glycosphingolipids
 GST (glutathione S-transferase) tag, in enzyme study, 70*f*
 GTP, 343, 615, 621, 623
 binding proteins, 269
 in phosphorylation, 118
 GTPases, 612
 small monomeric, 613, 622
 GTP-bound state, 623
 γ -Tubulin, 665
 Guanine, 341*t*
 oxidized by ROS, 759*f*
 Guanine nucleotide exchange factors, 612, 612*f*
 Guanosine, 340*f*, 341*t*
 base pairing of in DNA, 360, 361*f*
 in uric acid formation, 354, 355*f*
 Guanosine diphosphate, 571
 Guanosine monophosphate. *See* GMP
 Gyrate atrophy of retina, 299

H
 H1 histones, 371, 371*f*
 H2A histones, 371, 371*f*
 H2B histones, 371, 371*f*
 H2S. *See* Hydrogen sulfide
 H3 histones, 371, 371*f*
 H4 histones, 371, 371*f*
 Hageman factor (factor XII), 712*f*, 713, 713*f*, 713*t*, 714*t*
 Hairpin, 363, 364*f*, 469, 616
 Half-life
 enzyme, 288
 protein, 288
 plasma protein, 671
 Halt-transfer signal, 616
 Haplotype, 101
 Haplotype map (HapMap), 102
 HapMap database, 102
 Haptoglobin, 672–673, 672*t*
 Haptoglobin-related protein, 673
 Hartnup disease, 308, 557
 HAT activity. *See* Histone acetyltransferase activity
 Haworth projection, 153, 153*f*
 HbA_{1c} (glycosylated hemoglobin), 58–59
 H bands, 648, 649*f*
 HbA (hemoglobin A), P₅₀ of, 55
 HbF (fetal hemoglobin), P50 of, 55
 H blood group substances, 697–698, 697*f*
 HbM (hemoglobin M), 58, 417
 HbS (hemoglobin S), 58, 417
 hCG. *See* Human chorionic gonadotropin
 HDL. *See* High-density lipoproteins
 Health, normal biochemical processes as basis of, 3–4
 Heart
 metabolism in, 150*t*
 thiamin deficiency affecting, 546
 Heartbeat hypothesis, 764
 cholesterol and, 274
 Heart disease, coronary. *See* Atherosclerosis
 Heart failure, 217, 647
 in thiamin deficiency, 555
 Heat, from respiratory chain, 132
 Heat-shock proteins, as chaperones, 45, 610
 Heavy meromyosin, 650
 Heinz bodies, 694
 Helicases, DNA, 382*f*
Helicobacter pylori, 581
 stomach, epithelial cells of, 581
 ulcers associated with, 537
 Helix
 double, of DNA structure, 8, 360–361, 361*f*
 triple, of collagen structure, 46–47, 46*f*
 Helix-loop-helix motifs, 39
 Helix-turn-helix, 444
 Helper T cells, 707
 Hemagglutinin, 581
 Hematopoietic stem cells, blood cells derivation from, 689–690
 Hematuria, 597*t*
 Heme, 52, 52*f*
 catabolism of, bilirubin produced by, 330–332, 330*f*
 disorders of, 328*t*, 329*f*
 synthesis of, 325–327, 325*f*, 326*f*, 328*f*
 ALA synthase, 326–327
 incorporation of ferrous iron into protoporphyrin, 326
 Heme binding, 673
 Heme iron, 330
 absorption of, 541, 672*f*, 673
 hindered environment for, 53
 Heme metabolism, genetic disorders of, 329
 Heme oxygenase, 672
 Heme oxygenase system, 330, 330*f*
 Heme proteins, 323, 325*t*. *See also* Hemoglobin; Myoglobin
 catabolism of heme from, 330
 Heme synthase (ferrochelatase), 326, 328*f*
 in porphyria, 328*t*
 Hemiacetal, 153
 Hemiconnexin, 495*f*
 Hemin, 330, 330*f*
 Hemochromatosis, 541
 hereditary, 693
 Hemoglobin, 52–58, 670*f*
 2,3-bisphosphoglycerate stabilizing, 57*f*
 high altitude adaptation and, 57
 allosteric properties of, 54
 apoprotein, 55
 bilirubin synthesis and, 330, 330*f*
 in carbon dioxide transport, 57*f*
 extracorporeal, haptoglobin binding of, 672, 672*t*
 glycosylated. *See* HbA_{1c}
 hemoglobin A (HbA), P50 of, 55
 hemoglobin F (fetal hemoglobin), P50 of, 55
 hemoglobin Hikari, 417, 417*f*
 hemoglobin M, 57–58, 417
 hemoglobin S, 58, 417
 mutations, 57–58, 417
 oxygen affinities, 57–58
 oxygenation and conformational changes, 55–56
 oxygen dissociation curve for, 53
 in oxygen transport, 52–53
 in proton transport, 56
 secondary and tertiary structures, 54
 structure of, 54*f*
 tetrameric structure of, 52
 changes in during development, 55
 Hemoglobin Chesapeake, 58
 Hemoglobinopathies, 57, 694
 Hemoglobinuria, 597*t*
 paroxysmal nocturnal, 496*t*
 Hemojuvelin (HJV), 677
 Hemolysins, 694
 Hemolysis, 693*t*
 Hemolytic anemias, 168, 174, 204
 causes of, 694*f*
 glucose-6-phosphate dehydrogenase deficiency, 196, 204–205, 693–694
 possible chain of events in, 694*f*

- haptoglobin levels in, 673
 hyperbilirubinemia/jaundice in, 334, 334*t*
 peroxidase and, 200, 200*f*, 204
 Hemopexin, 672*t*, 673
 Hemophilia A, 717–718
 Hemophilia B, 717–718
 Hemoproteins, 120, 323, 325*t*
 Hemosiderin, 673
 Hemostasis, 698, 711–721. *See also* Coagulation (blood)
 laboratory tests in evaluation of, 721
 phases of, 711
 Henderson-Hasselbalch equation, 12
 Heparan sulfate, clotting/thrombosis affected by, 720
 Heparin, 159, 159*f*, 632, 637, 717
 antithrombin III activity affected by, 717
 lipoprotein and hepatic lipases affected by, 257
 structure of, 638*f*
 Heparin cofactor II, as thrombin inhibitor, 717
 Heparin/heparan sulfate, 634, 637–638
 Hepatic ALA synthase (ALAS1), 326–327
 in porphyria, 328*t*, 330
 Hepatic fructose
 hypertriacylglycerolemia/hypercholesterolemia/hyperuricemia and, 205
 metabolism affected by, 202–203, 202*f*
 Hepatic lipase, 257
 in chylomicron remnant uptake, 257, 257*f*
 deficiency of, 275*t*
 Hepatic portal system, 190
 in metabolite circulation, 142, 143*f*
 Hepatic purine biosynthesis, 350–352, 351*f*
 AMP and GMP formation regulation in, 350–352
 PRPP glutamyl amidotransferase regulation in, 350
 Hepatitis, 161
 jaundice in, 333*f*, 334*t*
 Hepatocytes, heme synthesis in, 325
 ALA synthase in regulation of, 326–327, 328*f*
 Hepatocellular degeneration (Wilson disease), 496*t*, 676
 ceruloplasmin levels in, 676
 gene mutations in, 496*t*, 677
 methylhistidine in, 315
 Hepsidin, 541, 676, 677*f*, 678*f*
 Hephaestin, 673
 Heptoses, 152, 153*t*
 Hereditary cancer conditions, 732*t*
 Hereditary elliptocytosis, 694, 696
 Hereditary hemochromatosis, 679, 693
 Hereditary nonpolyposis colon cancer, mismatch repair genes in, 390*t*
 Hereditary spherocytosis, 496*t*, 693*t*, 694
 causation of, 696
 Hermansky-Pudlak syndrome, 619*t*
 Hers disease, 179*t*
 Heterochromatin, 374
 Heterodimer, 41
 Heterotrophic organisms, 115
 Hexapeptide, in albumin synthesis, 671
 Hexokinase, 188*t*, 753
 in blood glucose regulation, 191, 192*f*
 in fructose metabolism, 202*f*, 203
 in glycogen biosynthesis, 176, 188*t*
 in glycolysis, 169, 170*f*, 188*t*
 as flux-generating reaction, 145
 regulation and, 172
 Hexosamines (amino sugars), 156, 156*f*
 glucose as precursor of, 203, 204*f*
 in glycosaminoglycans, 156, 204*f*
 in glycosphingolipids, 203, 204*f*
 interrelationships in metabolism of, 204*f*
 Hexose monophosphate shunt. *See* Pentose phosphate pathway
 Hexoses, 152, 153*t*, 154–155, 155*t*
 in glycoproteins, 155*t*
 metabolism of, 196–206, 197*f*, 199*f*, 200*f*. *See also* Pentose phosphate pathway
 physiologic importance of, 154–155, 155*t*
 HFE mutations, in hemochromatosis, 676
 HGP. *See* Human Genome Project
HhaI, 452*t*
 HHH syndrome. *See* Hyperornithinemia, hyperammonemia, and homocitrullinuria syndrome
 High altitude, adaptation to, 57
 High-density lipoproteins, 254*t*, 255
 apolipoproteins of, 254*t*, 255
 atherosclerosis and, 259, 274
 cycles, 259
 metabolism of, 258–259, 258*f*
 ratio to low density lipoproteins, 274
 receptor for, 258*f*, 259
 High-density microarray technology, 465
 High-energy phosphates, 115. *See also* ATP
 in energy capture and transfer, 115, 116*t*
 as “energy currency” of cell, 16–117, 131
 symbol designating, 115
 High-molecular-weight kininogen, 712*f*, 713
 High-performance liquid chromatography
 reversed phase, for protein/peptide purification, 26–27
 High-pressure liquid chromatography, 26–27
 “High-throughput” screening, 66–67
 Hill coefficient, 81
 Hill equation, 79–81
 Hindered environment, for heme iron, 53
HindIII, 452*t*
 Hippuric acid/hippurate, synthesis of, 315, 315*f*
 Histamine, 701*f*, 703*t*, 706
 formation of, 315
 Histidase (Histidine ammonia lyase), 299, 300*t*
 Histidine, 17*t*, 20, 315, 315*f*, 701*f*
 catabolism of, 299, 302*f*
 conserved residues and, 66*t*
 decarboxylation of, 315, 315*f*
 in oxygen binding, 53*f*
 requirements for, 544
 Histidine 57, in covalent catalysis, 64–65
 Histidine ammonia lyase (Histidase), 299, 300*t*
 Histidine E7, in oxygen binding, 52
 Histidine F8
 in oxygen binding, 52
 replacement of in hemoglobin M, 58
 Histidinemia, 299, 300*t*
 Histone acetyltransferase activity, 531
 Histone chaperones, 373
 Histone code, 437–438
 Histone covalent modification, 437
 Histone deacetylases, 94
 Histone dimer, 371, 373
 Histone epigenetic code, 438
 Histone octamer, 371, 371*f*, 373
 Histones, 371–373, 371*f*, 373*t*
 acetylation of, 735
 Histone tetramer, 371, 373
 HIV protease, in acid-base catalysis, 64, 64*f*
 HMGCoA. *See* 3-Hydroxy-3-methylglutaryl-CoA
 HMM. *See* Heavy meromyosin
 HNCC. *See* Hereditary nonpolyposis colon cancer
 Holocarboxylase synthetase, biotin as coenzyme of, 561
 Homeostasis
 blood in maintenance of, 669
 in ER, 618
 Homeostatic adaptations, 518
 Homoarginine, 19*t*
 Homocarnosine, 315, 316*f*, 319
 Homocarnosinosis, 319–320
 Homocysteine, 19*t*, 285*f*
 in cysteine and homoserine synthesis, 285
 functional folate deficiency and, 560
 Homocystinurias, 302, 316
 vitamin B₁₂ deficiency/functional folate deficiency and, 560
 Homodimers, 41
 Homogentisate dioxygenase/oxidase, 123
 Homogentisate, in tyrosine catabolism, 304, 305*f*
 Homogentisate oxidase, 300*t*
 deficiency of, in alkaptonuria, 300*t*, 304, 305*f*
 Homologous recombination of DNA, 389, 390*f*
 Homology, 102–103
 conserved residues and, 66
 modeling, 44
 in protein classification, 37
 Homopolymer tailing, 453
 Homoserine, 19*t*
 synthesis of, 285, 285*f*
 Hormonal regulation of cellular processes, 523*f*
 Hormonal regulation of lipolysis, 262–264
 Hormone-dependent cancer, vitamin B₆ deficiency and, 557
 Hormone receptor-G protein effector system, 521, 521*f*
 Hormone-receptor interaction, 518
 Hormone receptors
 classification, 500
 proteins as, 500
 recognition and coupling on, 499–500
 specificity and selectivity of, 499, 499*f*
 Hormone response elements
 defined, 529
 DNA sequences of, 519, 520*t*
 mapping, 443*f*
 Hormone response transcription unit, 530*f*
 Hormones, 569. *See also* specific hormones
 binding to cell surface receptors, 500, 501*t*
 binding to intracellular receptors, 500, 501*t*
 in blood glucose regulation, 191
 chemical diversity of, 501–502, 502*f*
 coordinated response to stimulus, 518–519, 519*f*
 definition, 498
 facilitated diffusion regulated by, 487
 features of, 501*t*
 lipid metabolism regulated by, 262–264, 263*f*
 lipophilic, 500
 in metabolic control, 145, 146*f*
 modified for full activity, 502
 plasma proteins in transport of, 516–517

- Hormones (*Cont.*):
 precursor molecule for, 501
 as second messenger, 500, 501*t*
 stimulating adenylyl cyclase, 521*t*
 storage and secretion of, 515
 synthesis of, 502
 1,25(OH)₂-D₃, 507–509
 adrenal steroidogenesis, 502–505
 angiotensin II, 513–514
 insulin, 512
 iodide metabolism and, 510–511
 ovarian steroidogenesis, 505, 507
 peptide precursors for, 511
 POMC family, 514–515, 515*f*
 PTH, 512–513
 testicular steroidogenesis, 505
 tetraiodothyronine, 510
 triiodothyronine, 510
 from tyrosine, 509–515
 vitamin D as, 551–553
 water-soluble, 500
 Hormone-sensitive lipase, 262, 262*f*
 insulin affecting, 262
 Housekeeping genes, 430
 Hp. *See* Haptoglobin
 Hpal, 452*t*
 HPETE. *See* Hydroperoxides
 HPLC. *See* High-performance liquid chromatography
 HREs. *See* Hormone response elements
 Hsp60/Hsp70, as chaperones, 45
 5-HT (5-hydroxytryptamine). *See* Serotonin
 Human β -interferon gene enhancer, 442*f*
 Human chorionic gonadotropin, 739*t*
 Human erythropoietin (EPO), 692
 Human evolution, 3
 Human gene mutation database, 102
 Human genes, localization of, 460*t*
 Human Genome Project, 3–4
 areas of current interest, 4*f*
 genomics and, 98
 implications, 3–4
 Human immunodeficiency virus type 1 (HIV-1), 581
 Human mitochondria, genes encoded by genome of, 760*t*
 Humoral immunity, 707
 Hunter syndromes, 638
 Hurler syndromes, 638
 Hyaline cartilage, principal proteins of, 643
 Hyaluronic acid, 156, 159*f*, 637, 640
 Hyaluronidase, 639
 Hybridization, 361, 456–457, 469
 Hybridomas, 685
 Hydrocortisone. *See* Cortisol synthesis
 Hydrogen bonds, 7, 7*f*
 in DNA, 360, 361, 361*f*
 enzyme-catalyzed reaction rate affected by, 78
 Hydrogen ion concentration. *See* pH
 Hydrogen peroxide, 760
 as hydroperoxidase substrate, 122–123
 Hydrogen sulfide, 132*f*
 Hydrolases, 61
 cholesteryl ester, 270–271
 fumarylacetoacetate, defect at, in tyrosinemia, 304
 gluconolactone, 198, 199*f*
 Hydrolysis (hydrolytic reactions), 9. *See also* specific reaction
 of bound GTP to GDP, 622
 free energy of, 115–116, 116*t*
 in glycogenolysis, 177*f*, 178
 of triacylglycerols, 246
 Hydrophathy plot, 481
 Hydroperoxidases, 122
 Hydroperoxides, 240, 243*f*
 Hydrophilic hormones, 516
 Hydrophilic portion of lipid molecule, 220, 221*f*
 Hydrophobic effect, in lipid bilayer self-assembly, 480
 Hydrophobic interaction chromatography, for protein/peptide purification, 27
 Hydrophobic interactions, 8, 360
 Hydrophobic membrane domains, 41
 Hydrophobic portion of lipid molecule, 220, 221*f*
 Hydrostatic pressure, 669
 3-Hydroxy-3-methylglutaryl-CoA (HMGCoA)
 in ketogenesis, 226–227, 228*f*
 in mevalonate synthesis, 267, 268*f*
 3-Hydroxy-3-methylglutaryl-CoA (HMGCoA) lyase
 deficiency of, 231
 in ketogenesis, 227, 228*f*
 3-Hydroxy-3-methylglutaryl-CoA (HMGCoA) reductase
 cholesterol synthesis controlled by, 267, 270*f*
 in mevalonate synthesis, 267, 267*f*
 3-Hydroxy-3-methylglutaryl-CoA (HMGCoA) synthase
 in ketogenesis, 227, 228*f*
 in mevalonate synthesis, 267, 267*f*
 3-Hydroxyanthranilate dioxygenase/oxygenase, 123
 3-Hydroxyanthranilate oxidase, 307*f*
 4-hydroxybutyric aciduria, 320
 24-Hydroxycalcidiol (24,25-dihydroxy vitamin D₃), in vitamin D metabolism, 552*f*
 25-Hydroxycholecalciferol (calcidiol), in vitamin D metabolism, 552*f*
 4-Hydroxydicoumarin (dicoumarol), 554
 18-hydroxylase, 503
 Hydroxylase cycle, 124, 124*f*
 Hydroxylases, 123
 in cortisol synthesis, 504–505
 27-Hydroxylase, sterol, 273
 Hydroxylation, 583
 in covalent modification, mass increases and, 31*t*
 Hydroxylysine, synthesis of, 285
 5-Hydroxymethylcytosine, 342, 342*f*
 Hydroxyproline, 628, 631
 catabolism of, 303–304, 304*f*
 synthesis of, 285, 285*f*
 4-Hydroxyproline dehydrogenase, defect in, in hyperhydroxyprolinemia, 303
 15-Hydroxyprostaglandin dehydrogenase, 240
 5-Hydroxytryptamine. *See* Serotonin
 Hyperalphalipoproteinemia, familial, 275*t*
 Hyperammonemia, 161, 167
 Hyperargininemia, 295–296
 Hyperbilirubinemia, 332–333, 334*t*
 jaundice caused by, 332
 unconjugated and conjugated, causes of, 334*t*
 unconjugated bilirubin elevated levels in blood, 332
 Hypercholesterolemia, 254, 258
 from fructose loading of liver, 205
 Hyperchromicity of denaturation, 361
 Hyperglycemia, 185. *See also* Diabetes mellitus
 Hyperglycemic glucosuria, 597*t*
 Hyperhomocysteinemia, folic acid supplements in prevention of, 560
 Hyperhydroxyprolinemia, 303
 Hyperkalemic periodic paralysis, 658*t*
 Hyperlacticacidemia, 261
 Hyperlipidemia, niacin for, 557
 Hyperlipoproteinemias, 254, 275, 275*t*
 Hyperlysinemia, 306
 Hypermetabolism, 168, 543
 Hypermethioninemia, 316
 Hyperornithinemia, hyperammonemia, and homocitrullinuria syndrome, 295
 Hyperornithinemia-hyperammonemia syndrome, 299
 Hyperoxaluria, primary, 301
 Hyperphenylalaninemias, 304
 Hyperprolinemias, types I and II, 299, 300*t*, 301*f*
 Hypersensitive sites, chromatin, 374
 Hypersplenism, 694
 Hyperthermia, malignant, 647, 654, 655*f*, 658*t*
 Hypertrophic cardiomyopathy, familial, 658–659, 659*f*
 Hyperuricemia, 355
 Hypervariable regions, 683
 Hypoglycemia, 185
 fatty acid oxidation and, 223, 231
 fructose-induced, 205
 Hypoglycemic effect of glucagon, 192
 Hypoglycin, 223, 231
 Hypokalemic periodic paralysis, 658*t*
 Hypolipidemic drugs, 275
 Hypolipoproteinemia, 254, 275, 275*t*
 Hypothyroidism, 217
 Hypoxanthine, 342, 342*f*
 Hypoxia, 736
 Hypoxia-inducible factor-1 (HIF-1), 736
 Hypoxia, lactate production and, 168, 171–172
- I**
 I. *See* Iodine/iodide
 I bands, 648, 649*f*
 Ibuprofen, 232, 240
 IC₅₀, 83
 I-cell disease, 496, 496*t*
 causation of, 581
 ICF. *See* Intracellular fluid
 Icterus (jaundice), 332, 334*t*
 IDDM. *See* Insulin-dependent diabetes mellitus
 Idiotypes, 684
 IDL. *See* Intermediate-density lipoproteins
 IEF. *See* Isoelectric focusing
 IgA, 681*t*, 682*t*, 683*f*
 IgD, 681*t*, 682*t*
 IgE, 681*t*, 682*t*
 IgG, 681*t*, 682*f*, 682*t*, 684*f*
 IgM, 681*t*, 682*t*, 683*f*
 Imatinib, 740, 740*t*
 Immune response, class/isotype switching and, 684
 Immune system
 adaptive, 706
 dysfunctions of, 686–687

- Immune thrombocytopenic purpura, 698
- Immunoassays, 595–596
- Immunocompromised state, 687
- Immunogenicity, lessening, 685
- Immunoglobulin genes, 684
 - DNA rearrangement and, 380–381
 - double-strand break repair and, 390*f*
- Immunoglobulin light chains, 681
 - genes producing, 684
 - DNA rearrangement and, 380–381
- Immunoglobulins, 668, 672*t*, 680–685, 682*t*. *See also* specific type under Ig
 - classes of, 682*t*
 - class switching and, 684
 - functions of, 681, 682*t*
 - genes for. *See* Immunoglobulin genes
 - hybridomas as sources of, 685
 - structure of, 683*f*, 684*f*
- IMP (inosine monophosphate)
 - conversion to AMP and GMP, 348, 349*f*
 - feedback regulation of, 351, 351*f*
 - synthesis of, 348–350, 349*f*, 350*f*
- Importins, 612, 612*f*
- Inborn errors of metabolism, 2, 297
 - screening neonates for, 596
- Inclusion cell (I-cell) disease, 496, 496*t*
- Indirect carcinogen, 725*f*
- Indole, permeability coefficient of, 481*f*
- Indomethacin, cyclooxygenases affected by, 240
- Induced fit model, 64, 64*f*
- Inducers
 - enzyme synthesis affected by, 89
 - in gluconeogenesis regulation, 187–188
 - gratuitous, 431
 - in regulation of gene expression, 430
- Inducible gene, 430
- Infantile Refsum disease, 231, 614, 614*t*
- Infection, protein loss and, 544
- Inflammation, 232
 - acute phase proteins in, 671
 - complement in, 685–686, 686*f*
 - prostaglandins in, 232
 - in relation to cancer, 742
- Influenza virus A, 581
- Information pathway, 520*f*
- Inhibit fertilization, 579
- Inhibition
 - competitive vs. noncompetitive, 81–84
 - feedback, in allosteric regulation, 90*f*, 91
 - irreversible, 83
 - mechanism-based, 83
 - tightly bound, 83
- Inhibitor-1, 180, 181*f*, 182, 183*f*
- Inhibitors of signal transduction, 740*t*
- Initial velocity, 78
 - inhibitors affecting, 82
- Initiation
 - in DNA synthesis, 384*f*, 386*f*
 - in protein synthesis, 419, 420*f*
 - in RNA synthesis, 396, 398
- Initiation complexes, in protein synthesis, 419, 420*f*
- Initiator methionyl-tRNA, 419
- Initiator sequence, 401
- Innate immune system, 685
- Innate immunity, 681
- Inner mitochondrial membrane, 127, 610
 - protein insertion in, 610
- Inorganic pyrophosphatase, in fatty acid activation, 117
- Inosine monophosphate (IMP)
 - conversion to AMP and GMP, 348, 349*f*
 - feedback-regulation of, 351, 351*f*
 - synthesis of, 348–350, 349*f*, 350*f*
- Inositol hexaphosphate (phytic acid), calcium absorption affected by, 541
- Inositol trisphosphate, 216
 - in chemotaxis, 702
 - in platelet activation, 719*f*, 720
- Inr. *See* Initiator sequence
- Inside-outside asymmetry, membrane, 482
- Insulators, 443–444
 - nonpolar lipids as, 212
- Insulin, 140, 502, 623
 - adipose tissue metabolism affected by, 262
 - biological assay to measure, 746, 747*t*
 - in blood glucose regulation, 192
 - deficiency of, 194. *See also* Diabetes mellitus
 - free fatty acids affected by, 254, 262
 - in glucose transport, 487
 - in glycolysis, 169
 - initiation of protein synthesis affected by, 422, 422*f*
 - in lipogenesis regulation, 237
 - in lipolysis regulation, 237, 262, 262*f*, 263*f*
 - on metabolic fuel reserves, 148
 - phosphorylase b affected by, 180
 - radioimmunoassay to measure, 746, 747*t*
 - secretion by rabbit pancreas, 753*t*
 - signal transmission by kinase cascades, 526, 527*f*
 - storage of, 515*t*
 - synthesis, 512
- Insulin-dependent diabetes mellitus, 193–194. *See also* Diabetes mellitus
- Insulin/glucagon ratio, in ketogenesis regulation, 230
- Insulin receptor, 500
- Integral proteins, 37, 482, 483*f*
 - cytoskeletal proteins interaction with, 695*f*
 - as receptors, 496
 - of red blood cell membrane, 695–696, 695*f*, 695*t*
- Integration, chromosomal, 379–380, 380*f*
- Integrins
 - neutrophils, 702–703, 703*t*
 - platelets, 702–703, 703*t*
 - white blood cells, 702–703, 703*t*
- Intercostal skeletal muscle cells, turnover, 757*t*
- Interferons, 706
- Interleukin-6 (IL-6), 677
- Interleukins, 690, 706
- Intermediary proteins and cargo molecules, 622
- Intermediate-density lipoproteins, 254*t*, 258, 272
- Intermediate filaments, 664*t*, 665
- Intermembrane mitochondrial space, proteins in, 610
- Intermittent branched-chain ketonuria, 309
- Internal presequences, 610
- Internal ribosomal entry site, 425, 426*f*
- Interphase chromosomes, chromatin fibers in, 373
- Intervening sequences. *See* Introns (intervening sequences)
- Intestinal bacteria, in bilirubin metabolism, 332
- Intestinal epithelium turnover, 757*t*
- Intracellular environment, membranes in
 - maintenance of, 478, 478*t*
- Intracellular fluid, 478, 478*t*
- Intracellular membranes, 477
- Intracellular signals, 520
- Intracellular traffic, 607–626. *See also* Protein sorting
 - disorders due to mutations in genes encoding, 614*t*, 625
 - transport vesicles in, 620–624
- Intravasation, 736
- Intrinsic factor, 541, 558
 - in pernicious anemia, 559
- Intrinsic pathway of blood coagulation, 712*f*, 713–714
- Intrinsic tenase complex, 713
- Introns (intervening sequences), 376, 376*f*, 380, 407, 413, 469
 - removal from primary transcript, 407*f*
- Inulin, 156–157
- Inulin clearance, 597
- Iodide metabolism
 - and hormone synthesis, 510–511
 - in thyroid follicle, 510–511, 511*f*
- Iodine/iodide, 562
- 5-Iodo-2'-deoxyuridine, 344*f*
- Iodopsin, 547
- 5-Iodouracil, 344
- Ion channels, 477, 487–489, 488*f*, 489*t*, 491, 496, 658*t*
 - in cardiac muscle, 657, 658*t*
 - diseases associated with disorders of, 658*t*
- Ion exchange chromatography, protein/peptide purification by, 27
- Ionizing radiation, nucleotide excision-repair of
 - DNA damage caused by, 389*t*
- Ionophores, 134, 489–490
- Ion product, 10
- IP3. *See* Inositol trisphosphate
- IPTG. *See* Isopropylthiogalactoside
- IRES. *See* Internal ribosomal entry site
- Iron, 550*t*
 - absorption of, 541, 542*f*, 672*f*, 673
 - in hemochromatosis, 541
 - vitamin C and ethanol affecting, 541
 - ferrous, in oxygen transport, 52–53
 - heme, 330, 673
 - absorption of, 323, 541
 - hindered environment for, 53
 - in methemoglobinemia, 57
 - incorporation into protoporphyrin, 324*f*, 326
 - metabolism of, 672*f*, 673
 - nonheme, 673
 - overload, 679*t*
 - transferrin in transport of, 673–674
 - Iron-binding capacity, total, 674
 - Iron deficiency anemia, 693*t*
 - Iron deficiency/iron deficiency anemia, 541
 - Iron-deficient erythropoiesis, 678
 - Iron overload, 541
 - Iron porphyrins, 323
 - Iron response elements, 676
 - Iron-sulfur proteins, in respiratory chain
 - complexes, 127–128, 129*f*
 - Irreversible covalent modifications, 92, 93*f*
 - Irreversible inhibition, enzyme, 83

- Ischemia, 168, 496
 Islets of Langerhans, insulin produced by, 192
 Isoaspartyl linkage in polypeptide backbone, 763f
 Isoaspartyl methyltransferase, 763f
 Isocitrate dehydrogenase, 163, 163f
 in NADPH production, 234, 235f
 Isoelectric focusing, 29, 29f
 Isoelectric pH (pI), amino acid net charge and, 20–21
 Isoenzymes. *See* Isozymes
 Isoleucine, 16t
 catabolism of, 309, 310f, 311f
 interconversion of, 285
 requirements for, 544
 Isomaltose, 157t
 Isomerases, 61
 Isomerism
 geometric, of unsaturated fatty acids, 213, 215f
 of sugars, 153–154, 154f
 Isomerism of steroids, 218–219, 218f
 Isomorphous displacement, 43
 Isopentenyl diphosphate, in cholesterol synthesis, 267, 268f
 Isoprene units, polyprenoids synthesized from, 219, 220f
 Isoprenoids, synthesis of, 267, 268f
 in cholesterol synthesis, 269f
 Isopropylthiogalactoside, 431
 Isoprostanol (prostanoids), 213, 220
 cyclooxygenase pathway in synthesis of, 240–241, 241f
 Isosteric enzymes, 91
 Isothermic systems, biologic systems as, 113
 Isotopes. *See* specific types
 Isotypes, 684
 Isotype (class) switching, 684
 Isovaleric acidemia, 309
 Isovaleryl-CoA dehydrogenase, 300t
 in isovaleric acidemia, 309
 Isozymes, 66
- J**
 Jak/STAT pathway, 526, 528, 528f
 Jamaican vomiting sickness, 231
 Jaundice (icterus), 323, 332, 334t, 598
 J chain, 683f
 Joining region, gene for, 684
 “Jumping DNA,” 380
 Junctional diversity, 684
- K**
 K. *See* Potassium
 k. *See* Rate constant
 Kartagener syndrome, 665
 Karyopherins, 612
 Karyotype, 375f
 K_{cat} . *See* Catalytic constant
 K_{cat}/K_m . *See* Catalytic efficiency
 K^+ channel, 489, 489f, 490f
 Kd. *See* Dissociation constant
 KDEL-containing proteins, 608t, 618
 K_{eq} . *See* Equilibrium constant
 Keratan sulfate I, 637
 Keratins, 666
 Kernicterus, 332
 Ketoacidosis, 223, 231
 in diabetes mellitus, 149
 3-Ketoacyl-CoA thiolase deficiency, 231
 3-Ketoacyl synthase, 233, 234f
 Ketoamines, 578
 Ketogenesis, 141f, 144, 226–230. *See also* Fatty acids, oxidation of
 high rates of fatty acid oxidation and, 226–229, 227f, 228f
 HMG-CoA in, 226–227, 228f
 regulation of, 229–230, 229f
 Ketogenic amino acids, 146
 Ketoglutarate transporter, 134, 135f
 Ketone bodies, 141, 141f, 143, 223, 227f
 in fasting state, 149
 free fatty acids as precursors of, 229
 as fuel for extrahepatic tissues, 227, 229f
 in starvation, 148t, 149, 149f
 Ketonemia, 227
 Ketonuria, 231
 branched chain (maple syrup urine disease), 309
 Ketoses (sugars), 152–153, 153t, 154, 155f
 Ketosis, 223, 229, 231
 in cattle
 fatty liver and, 261
 lactation and, 231
 in diabetes mellitus, 149, 231
 ketoacidosis caused by, 231
 in lactation, 149
 nonpathologic, 231
 in starvation, 231
- Kidney
 basement membrane of, 638
 in fasting state, 149
 metabolism in, 150t
 vitamin D metabolism in, 552
 Kinases protein. *See* Protein kinases
 Kinetics (enzyme), 73–86. *See also* Catalysis/
 catalytic reactions (enzymatic)
 activation energy affecting, 74–75
 balanced equations and, 74
 competitive vs. noncompetitive inhibition and, 81–84
 in drug development, 85
 factors affecting reaction rate and, 75–77
 free energy changes affecting, 75
 initial velocity and, 78
 multisubstrate enzymes and, 84
 saturation, 81
 sigmoid (Hill equation), 81
 substrate concentration and, 78–79, 82
 models of effects of, 79–81
 transition states and, 74–75
 Kinetic (collision) theory, 75
 Kinetochore, 374
 Kininogen high-molecular-weight, 712f, 713
 K_m . *See* Michaelis constant
 Knockout genes, 464–465
 Korsakoff psychosis, 556
 Kozak consensus sequences, 421
 Krabbe disease, 251t
 Krebs cycle. *See* Citric acid cycle
 Kw. *See* Ion product
 Kwashiorkor, 281, 541, 542–543
 Kynureninase, 307f, 308
 Kynurenine-anthranilate pathway for tryptophan
 catabolism, 306, 307f
 Kynurenine formylase, 307f, 308
 Kynurenine hydroxylase, 307f
- L**
 L(+)-3-Hydroxyacyl-CoA dehydrogenase, 225, 225f
 Lab diagnoses of thyroid disorders, 598t
 Labile factor (factor V), 713f, 713t, 714
 Laboratory (lab) tests
 biochemical tests. *See* Biochemical laboratory tests
 causes of abnormalities in levels of analytes measured in, 589–590, 590t
 importance in clinical medicine, 589
 organ function tests, 596–599, 596t, 597t, 598t
 reference range of, 590–591
 result validity, 591–592
 samples for analysis, 593
 techniques used in clinical chemistry, 593–596
 validity assessment, 592–593
 lacA gene, 430f, 431, 432f
 lacI gene, 431, 432f
 lac operon, 430, 430f, 432f
 lac repressor, 431, 432f
 Lactase, 152, 538
 deficiency of (lactose/milk intolerance), 537
 Lactate
 anaerobic glycolysis and, 168, 170f, 171–172
 hypoxia and, 171–172
 Lactate dehydrogenase, 40, 42f, 321f
 in anaerobic glycolysis, 171
 isozymes, 69
 diagnostic significance of, 68t, 69, 69f
 Lactation, ketosis in, 149
 Lactic acid cycle, 190, 191f
 Lactic acidosis, 168
 from inherited mitochondrial defects, 127
 pyruvate metabolism and, 174
 thiamin deficiency and, 556
 Lactic acid, pK/pK_a value of, 13t
 Lactoferrin, 704t
 Lactose, 152, 156, 157f, 157t, 203
 galactose in synthesis of, 203, 203f
 intolerance, 152, 537, 538
 metabolism of, operon hypothesis and, 430–433, 430f
 Lactose synthase, 203, 203f
 Lactulose, 157t
 lacY gene, 430f, 431
 lacZ gene, 430f, 431
 LAD II (Leukocyte adhesion deficiency II), 580
 Lagging (retrograde) strand, in DNA replication, 382f, 383, 385f
 Lambda repressor (cI) protein/gene, 433–437, 433f, 436f
 Laminin, 634
 cell interacting, schematic representation of, 634f
 L-amino acids in proteins, 19–20
 metabolic roles, 19
 Lamins, 666
 Langerhans, insulin produced by islets of, 192
 Lanosterol, in cholesterol synthesis, 267, 268, 269, 269f
 Latch state, 660
 Lauric acid, 213t
 Laws of thermodynamics, 113–114
 hydrophobic interactions and, 8
 LBD. *See* Ligand-binding domain

- LCAT. *See* Lecithin:cholesterol acyltransferase
- L chains. *See* Light chains
- LCRs. *See* Locus control regions
- LDL. *See* Low density lipoproteins
- LDL:HDL cholesterol ratio, 274
- Leader sequence. *See* Signal peptide
- Leading (forward) strand, in DNA replication, 382*f*, 383
- Lead poisoning, ALA dehydratase inhibition and, 325
- Lecithin:cholesterol acyltransferase, 249, 258*f*, 259, 272
 familial deficiency of, 275*t*
- Lecithins, 159, 215, 217*f*, 572. *See also* Phosphatidylcholines
 examples/comments, 572*t*
 membrane asymmetry and, 482
 metabolism of, 249*f*
 plant, 572*t*
 synthesis of, 246, 246*f*, 247*f*
- Lectin pathway, 686
- Leiden factor V, 171
- Lens of eye, fructose and sorbitol in, diabetic cataract and, 205
- Leptin, 261
- Lesch-Nyhan syndrome, 354–355
- Leucine, 16*t*
 catabolism of, 309, 310*f*
 interconversion of, 285
 requirements for, 544
- Leucine zipper, 444
- Leucine zipper motif, 445
- Leucovorin, 559
- Leukemias, 699, 700
- Leukocyte adhesion deficiency (LAD) II, 580
- Leukocyte-endothelial cell interactions, 579
- Leukocytes, 579, 701–703
 communication through effectors, 706
 polymorphonuclear, 701
 turnover, 757*t*
- Leukodystrophy, metachromatic, 251*t*
- Leukopenia, 700
- Leukotrienes, 213, 214*f*, 239, 240, 242, 706
 clinical significance of, 240
 leukotriene A₄, 214*f*
 lipoxygenase pathway in formation of, 240, 241*f*, 243*f*
- L-Glucose, 154*f*
- L-Glutamate decarboxylase, 320, 321*f*
- L-Gulonolactone oxidase, 200
- Library, 469
- L-Iduronate, 154–155, 156*f*
- Life expectancy
 average, 756*t*
 calculation, 756
- Lifespan
 evolution and, 766
 vs. longevity, 756
- Lifespan vs. body mass for mammals, 764, 764*t*
- Lifestyle changes, cholesterol levels affected by, 274–275
- Ligand-binding domain, 530
- Ligand-gated channels, 489, 658*t*
- Ligand-receptor complex, 519–520, 519*f*
- Ligases, 61, 619
- Ligation, 469
- Light chain protein phosphatase, 660
- Light chains
 DNA rearrangement and, 380–381
 genes producing immunoglobulin, 684
- Light, energy source in active transport, 490
- Light meromyosin, 650
- Limit dextrinosis, 179*t*
- LINEs. *See* Long interspersed repeat sequences
- Lines, definition of, 469
- Lineweaver-Burk plot, 82*f*, 83*f*, 85*f*
 inhibitor evaluation and, 83
 K_m and V_{max} estimated from, 79–80
- Lingual lipase, 539
- N-linked glycoproteins, 574–577
- Linoleic acid/linoleate, 213*t*, 238, 238*f*, 239
 in essential fatty acid deficiency, 239
 synthesis of, 239*f*
- Lipases
 diagnostic significance of, 68*t*
 in digestion, 539
 in triacylglycerol metabolism, 246, 262, 262*f*, 539
- Lipid bilayer, 481, 481*f*
 membrane proteins and, 481
- Lipid compositions of ER, 624
- Lipid core, of lipoprotein, 254–255
- Lipid droplets, 261, 263–264
- Lipidomics, 3
- Lipidoses (lipid storage disorders), 251
- Lipid peroxidation, 758
- Lipid rafts, 216, 484, 623, 624
- Lipids, 212–221. *See also* specific type
 amphipathic, 220–221, 221*f*
 asymmetry of, membrane assembly and, 624, 624*f*
 classification of, 212
 complex, 212
 derived, 212
 digestion and absorption of, 538–539, 540*f*
 disorders associated with abnormalities of, 496
 fatty acids, 212–215
 glycolipids, 212, 218, 218*f*
 interconvertibility of, 148
 in membranes, 479–481
 metabolism of, 140–141, 141*f*, 143, 143*f*.
See also Lipolysis
 in fed state, 148
 in liver, 259–260, 260*f*
 neutral, 212
 peroxidation of, 219–220, 220*f*
 phospholipids, 212, 215–217, 216*f*
 precursor, 212
 ratio of protein to, in membrane, 478–479, 478*f*
 simple, 212
 steroids, 218–219, 218*f*, 219*f*
 transport and storage of, 254–255
 adipose tissue and, 261, 262*f*
 brown adipose tissue and, 264, 264*f*
 clinical aspects of, 260–261
 fatty acid deficiency and, 241
 as lipoproteins, 254–255, 254*t*, 255*f*
 liver in, 259–260, 260*f*
 triacylglycerols (triglycerides), 215, 216*f*
 turnover of, membranes and, 624–625
- Lipid storage disorders (lipidoses), 251, 251*t*
- Lipogenesis, 142, 143, 148, 232–236, 233*f*, 234*f*, 261, 264
- acetyl-CoA for, 234–235
 fatty acid synthase complex in, 233–234, 233*f*, 234*f*
 malonyl-CoA production in, 233, 233*f*
 NADPH for, 234, 235*f*
 regulation of, 236–238, 237*f*
 enzymes in, 188*t*, 233–234, 237
 nutritional state in, 236
 short- and long-term mechanisms in, 236–238
- Lipolysis, 143, 143*f*, 261–264. *See also* Lipids
 hormones affecting, 262–263, 263*f*
 hormone-sensitive lipase in, 261–262, 262*f*
 insulin affecting, 237
 triacylglycerol, 246
- Lipophilic hormones, 500
- Lipoprotein(a) excess, familial, 275*t*
- Lipoprotein lipase, 143, 143*f*, 257, 257*f*, 258*f*, 637
 familial deficiency of, 275*t*
 involvement in remnant uptake, 258
- Lipoproteins, 37, 143, 253–265, 254*t*, 255*f*, 669, 672*t*. *See also* specific type
 carbohydrates in, 159
 in cholesterol transport, 271–272, 272*f*
 classification of, 254, 254*t*
 deficiency of, fatty liver and, 261
 disorders of, 275–276, 275*t*
 remnant, 254*t*, 257*f*, 258
 liver uptake of, 258
- Liposomes, 482
 amphipathic lipids forming, 220–221, 221*f*
 artificial membranes and, 482–483
- Lipotropic factor, 261
- Lipoxins, 213, 214*f*, 239, 240
 clinical significance of, 242
 lipoxygenase pathway in formation of, 240, 241*f*, 243*f*
- Lipoxygenase, 240, 243*f*
 reactive species produced by, 220
- 5-Lipoxygenase, 240, 243*f*
- Lipoxygenase pathway, 239, 240, 241*f*, 243*f*
- Liquid chromatography, 26–27, 27*f*
- L isomerism, 153, 154*f*
- Lithium, 562*t*
- Lithocholic acid, synthesis of, 273*f*, 274
- Liver
 bilirubin uptake by, 331, 331*f*
 cirrhosis of, 161, 261
 in fasting state, 148
 fatty
 alcoholism and, 261
 of pregnancy, 231
 triacylglycerol metabolism imbalance and, 260–261
 fructose 2,6-bisphosphate in regulation of, 189, 190*f*
 glycogen, 177*f*
 lipid, 260*f*, 261
 fructose overload and, 205
 glucose uptake into, 148
 glycogen in, 176–178, 177*t*
 glycogenolysis in, 178
 heme synthesis in, 326–327
 ALA synthase in regulation of, 326–327, 328*f*
 ketone bodies produced by, 227, 227*f*, 229

- Liver (*Cont.*):
 metabolism in, 141, 141*f*, 143*f*, 150*t*, 161
 fatty acid oxidation and ketogenesis, 226–229, 227*f*, 228*f*
 fructose, 202–203, 202*f*
 glucose, 186*f*, 189, 191*f*
 phosphorylase in, control of, 179–180
 plasma protein synthesis in, 143, 670
 vitamin D metabolism in, 552, 552*f*
 vitamin D₃ synthesis in, 552*f*
- Liver function tests, 597–598, 598*t*
- Liver phosphorylase deficiency, 179*t*
- LMM. *See* Light meromyosin
- LMWHs. *See* Low-molecular-weight-heparins
- Lock and key model, 64
- Locus control regions, 443–444
- Long-chain fatty acids, 133
- Longevity vs. lifespan, 756
- Long interspersed repeat sequences, 377
- Long noncoding RNA, 394
- Looped domains, chromatin, 372*f*, 375
- Loops (protein conformation), 39
- Low density lipoprotein receptor-related protein, 255
 in chylomicron remnant uptake, 257*f*, 258
- Low density lipoproteins, 254*t*, 255, 267, 271
 apolipoproteins of, 254*t*, 255
 metabolism of, 257*f*, 258
 ratio to high-density lipoproteins, and atherosclerosis, 274
 receptors for, 258
 in chylomicron remnant uptake, 257*f*, 258
 in cotranslational insertion, 616, 617*f*
- Low-energy phosphates, 115
- Low-molecular-weight heparins, 717
- LRP. *See* Low density lipoprotein receptor-related protein
- L-Tryptophan dioxygenase (tryptophan pyrrolase), 123
- LTs. *See* Leukotrienes
- L-type calcium channel, 656
- Lubricate, 574
- Lung surfactant, 245
 deficiency of, 216, 250
- Lupus, 700
- LXs. *See* Lipoxins
- L-Xylulose, 155*t*
 accumulation of in essential pentosuria, 205
- Lyases, 61
- Lymphocytes, 706–707. *See also* B lymphocytes; T lymphocytes
- Lymphoid progenitor cells, 701
- Lysine, 17*t*
 catabolism of, 306, 306*f*
 pI of, 20–21, 21*f*
 requirements for, 544
- Lysine acetyltransferases, 94
- Lysine hydroxylase, vitamin C as coenzyme for, 562
- Lysis, complement in cell, 685
- Lysis test, hereditary erythroblastic multinuclearity with, 580
- Lysogenic pathway, 433, 433*f*
- Lysolecithin, 217, 217*f*, 249, 249*f*
- Lysophosphatidylcholine, 217, 217*f*
- Lysophospholipase, 249, 249*f*
- Lysophospholipids, 217, 217*f*
- Lysosomal degradation pathway, defect in
 lipidoses, 251
- Lysosomal enzymes in I-cell disease, 496, 496*t*
- Lysosomal proteases, in protein degradation, 620
- Lysosomal proteins, 625
- Lysosomes, 581
 in endocytosis, 492
 protein entry into, disorders associated with defects in, 619*t*, 625
- Lysozyme, 40*f*, 704*t*
- Lysyl hydroxylases, 638
 deficiencies of, 631
 in hydroxylysine synthesis, 285
- Lysyl oxidase, 628, 631
- Lytic/lysogenic switch configuration of, 434*f*
- Lytic pathway, 433, 433*f*
- M**
- Macromolecules, cellular transport of, 492–493, 492*f*, 495*f*
- Macrophages, 701, 706
- Mad cow disease (bovine spongiform encephalopathy), 45
- Magnesium, 562*t*
 in chlorophyll, 323
 in extracellular and intracellular fluid, 478, 478*t*
- Maillard reaction, 578
- Major groove, in DNA, 361*f*, 362
- operon model and, 431
- Major histocompatibility class I molecules, 620
- Major histocompatibility complex (MHC), 704
- Major sorting decision, 607
- Malaria, 581
- Malate, 163*f*, 164
- Malate dehydrogenase, 163*f*, 164
- Malate shuttle, 134, 135*f*
- MALDI. *See* Matrix-assisted laser-desorption
- Maleylacetoacetate, in tyrosine catabolism, 304, 305*f*
- Malic enzyme, in NADPH production, 234, 234*f*, 235*f*
- Malignancy/malignant cells. *See* Cancer; Cancer cells
- Malignant hyperthermia, 654–655, 655*f*, 658*t*
- Malonate
 on respiratory chain, 132, 132*f*
 succinate dehydrogenase inhibition by, 82
- Malonyl-CoA, in fatty acid synthesis, 233, 233*f*
- Malonyl transacylase, 233, 233*f*, 234*f*
- Maltase, 538
- Maltose, 156, 157*f*, 157*t*
- Mammalian asialoglycoprotein receptor, 572
- Mammalian coregulator proteins, 532*t*
- Manganese, 562*t*
- Mannan-binding protein (MBP), 686, 687*f*
- Mannosamine, 203, 204*f*
- Mannose-binding protein, 580
- Mannose 6-phosphate/mannose 6-P signal in protein flow, 608*t*
- Mannose 6-phosphate receptor proteins, 581
- Mannose 6-P signal, 581
- Manual enzymatic method, 457
- Maple syrup urine disease (branched-chain ketonuria), 309
 α -Ketoacid Decarboxylase Complex impaired function in, 311*t*
- MAPs. *See* Microtubule-associated proteins
- Marasmus, 113, 281, 541, 542–543
- Marfan syndrome, 632, 632*f*
- Mass spectrometry, 31–33, 32*f*
 configurations, 31–33
 covalent modifications detected by, 31
 peptides/proteins, analysis of, 31–33
 quadrupole, 31
 tandem, 33
 detection of metabolic diseases, 296
 transcript-protein profiling and, 465
- Mast cells, 700, 706
- MAT. *See* Methionine adenosyltransferase
- Matrix
 extracellular. *See* specific component
 mitochondrial, 127, 162
- Matrix-assisted laser-desorption (MALDI), in mass spectrometry, 31, 32*f*
- Matrix-processing protease, 610
- Matrix proteins, 610, 614
 diseases caused by defects in import of, 614
- Maximal velocity
 allosteric effects on, 91
 inhibitors affecting, 82–83
- MBP. *See* Mannose-binding protein
- McArdle disease/syndrome, 179*t*
- Mechanically gated ion channels, 658*t*
- Mechanism-based inhibition, 83–84
- Medicine
 preventive, biochemical research affecting, 3
 relationship of to biochemistry, 2–3, 2*f*
- Medium-chain acyl-CoA dehydrogenase, deficiency of, 231
- Megaloblastic anemia
 folate deficiency causing, 560
 vitamin B₁₂ deficiency causing, 559
- Megaloblastic anemias, 693*t*
- MELAS, 135
- Melatonin, biosynthesis and metabolism of, 319*f*
- Melting temperature/transition temperature, 361, 483
- Membrane assembly, 614
- Membrane attack complex (MAC), 685
- Membrane-bound mucins, 574
- Membrane-bound polyribosomes, 614
- Membrane fatty acid-transport protein, 255
- Membrane fusion, 621
- Membrane lipids
 amphipathic nature of, 479–480
 bilayer formation, 480–481, 480*f*, 481*f*
 glycosphingolipids, 479
 phospholipids, 479
 sterols, 479
- Membrane proteins, 481, 489*t*, 614. *See also* Glycoproteins
 association with lipid bilayer, 481
 integral, 37, 482, 483*f*
 mutations affecting, diseases caused by, 496, 496*t*
 peripheral, 482, 483*f*
 structure of, dynamic, 481
- Membranes, 477–496
 artificial, 482–483
 asymmetry of, 479, 482
 bilayers of, 480*f*, 481
 membrane protein association and, 481
 biogenesis of, 624–625, 624*f*, 625*t*

- cholesterol in, 479
 fluid mosaic model and, 484
 depolarization of, in nerve impulse transmission, 491
 fluidity affecting, 484
 glycosphingolipids in, 479
 Golgi apparatus in synthesis of, 608
 intracellular, 478
 lipids in, 220–221, 221*f*, 479–480, 480*f*. *See also* Membrane lipids
 mutations affecting, diseases caused by, 496, 496*t*
 phospholipids in, 215–217, 217*f*, 479, 479*f*
 plasma. *See* Plasma membrane
 protein:lipid ratio in, 478–479, 478*f*
 proteins in, 481, 489*t*. *See also* Membrane proteins
 selectivity of, 485–490, 485*f*, 485*t*, 488*f*, 489*t*
 sterols in, 479
 structure of, 478–482, 478*f*
 asymmetry and, 482
 fluid mosaic model of, 483–484, 483*f*
 Membrane transport, 485*f*, 485*t*, 486*f*, 487, 488*f*.
 See also specific mechanisms
 Membranous bone, 641*f*
 Menadiol, 554, 554*f*
 Menadiol diacetate, 554, 554*f*
 Menadione, 554. *See also* Vitamin K
 Menaquinone, 554, 554*f*. *See also* Vitamin K
 Menkes syndrome, 47, 281–282
 deficiency of copper, 631
 MEOS. *See* Cytochrome P450-dependent microsomal ethanol oxidizing system
 6-Mercaptopurine, 344, 344*f*
 Mercuric ions, pyruvate metabolism affected by, 174
 Meromyosin
 heavy, 650
 light, 650
 Messenger RNA, 365, 366*f*, 394, 413, 421*f*, 449. *See also* RNA
 codon assignments in, 413, 414*t*
 editing of, 409–411
 exporter, 613
 modification of, 409–411
 molecules, 612
 nontranslating, 425
 nucleotide sequence of, 414
 mutations caused by changes in, 417–418, 418*f*
 polycistronic, 430
 relationship to chromosomal DNA, 376*f*
 transcription starting point and, 396
 Metabolic acidosis, ammonia in, 292
 Metabolic alkalosis, ammonia in, 292
 Metabolic diseases of amino acid metabolism, 300*t*
 Metabolic fuels, 146–149. *See also* Digestion
 clinical aspects of, 149
 diet providing, 541
 in fed and starving states, 146–149, 147*f*, 148*t*, 149*f*
 interconvertibility of, 146–149
 in normal adult, 139
 provision of, 139–150. *See also* Metabolism
 Metabolic pathway/metabolite flow, 141–145. *See also* specific type and specific types and Metabolism
 flux-generating reactions in, 145
 nonequilibrium reactions in, 145
 regulation of, 88–89, 88*f*, 145, 146*f*
 covalent modification in, 92
 unidirectional nature of, 88
 Metabolic theories of aging, 764–765
 Metabolism, 114, 139–150, 150*t*. *See also*
 Catalysis/catalytic reactions (enzymatic);
 Metabolic pathway/metabolite flow;
 specific types
 allosteric regulation and, 90–91, 90*f*, 145, 146*f*
 blood circulation and, 141*f*, 142–143, 143*f*
 compartmentation and, 88–89
 control of quantity and, 89–90
 covalent modification and, 90, 92, 93*f*
 of drugs, in vivo, 85
 group transfer reactions in, 9
 inborn errors of, 2, 297
 integration of, metabolic fuels and, 141–145
 rate-limiting reactions and, 89
 regulation of, 88*f*, 89, 145, 146*f*
 allosteric and hormonal mechanisms in, 90–91, 90*f*, 145, 146*f*
 enzymes in, 145, 146*f*
 at subcellular level, 144–145, 144*f*
 at tissue and organ levels, 141*f*, 142–143, 150*t*
 Metabolite flow, 88
 Metabolomics, 3, 465
 Metachromatic leukodystrophy, 251*t*
 Metal-activated enzymes, 62
 Metal ions, in enzymatic reactions, 62
 Metalloenzymes, 62
 Metalloflavoproteins, 120
 Metalloproteins, 37
 Metaphase chromosomes, 374, 375, 375*f*, 375*t*, 379, 379*f*
 Metastasis, 569, 738*t*
 and cancer, 736–738
 genes enhancing, 738
 membrane abnormalities and, 496*t*
 simplified scheme of, 737*f*
 Methacrylyl-CoA, catabolism of, 311*f*
 Methemoglobin, 57–58, 417, 692
 Methemoglobinemia, 57, 692–693, 693*t*
 Methionine, 17*t*, 315, 316*f*
 active (S-adenosylmethionine), 308, 308*f*, 315–316, 316*f*, 343, 343*f*, 344*t*
 catabolism of, 308, 308*f*, 309*f*
 in folate trap, 558*f*
 requirements for, 544
 Methionine adenosyltransferase, 300*t*, 315–316, 316*f*
 Methionine synthase, 558
 Methotrexate, 353–354, 559
 dihydrofolate/dihydrofolate reductase affected by, 353–354
 N-methyl-4-aminoazobenzene structure, 725*f*
 Methylation, 587
 in covalent modification, mass increases and, 31*t*
 Methylation of cytosine bases, 735
 5-Methylcytosine, 342, 342*f*
 Methylene tetrahydrofolate, 559–560, 560*f*
 in folate trap, 559–560
 7-Methylguanine, 342*f*
 7-Methylguanosine cap structure, mRNA, 409
 Methylhistidine in Wilson disease, 315
 Methylmalonicaciduria, 187
 Methylmalonyl-CoA, accumulation of in vitamin B₁₂ deficiency, 558
 Methylmalonyl-CoA isomerase (mutase), in propionate metabolism, 186*f*, 187, 187*f*, 558
 Methylmalonyl-CoA mutase (isomerase), 187, 187*f*, 558
 Methylmalonyl-CoA racemase, in propionate metabolism, 187, 187*f*
 Methyl pentose, in glycoproteins, 159*t*
 Methyl-tetrahydrofolate, in folate trap, 559–560
 Mevalonate, synthesis of, 267, 268*f*
 in cholesterol synthesis, 267*f*, 268*f*
 Mg. *See* Magnesium
 MI. *See* Myocardial infarction
 mi and small interfering (si) RNA, 368
 Micelles, 480, 480*f*, 481
 amphipathic lipids forming, 220–221, 221*f*, 480, 480*f*
 in lipid absorption, 539
 Michaelis constant, 79
 allosteric effects on, 91
 binding constant approximated by, 81
 enzymatic catalysis rate and, 79, 88, 88*f*
 of glutathione reductase, 748
 inhibitors affecting, 82–83
 Michaelis-Menten equation, 79
 Bi-Bi reactions and, 84
 regulation of metabolite flow and, 88, 88*f*
 substrate concentration and, 79–81
 Microalbuminuria, 597
 Microbial toxins, 490
 Microfibrils, 632
 Microfilaments, 665
 Micronutrients, 546–563. *See also* specific micronutrients
 vitamins. *See* Vitamins
 Micro (mi) RNAs, 368, 447–448
 Microsatellite instability, 378, 731
 Microsatellite polymorphisms (DNA), 378, 463–464, 469
 Microsatellite repeat sequences, 377–378, 469
 Microsomal elongase system, 236, 237*f*
 Microsomal triglyceride transfer protein (MTP), 259
 Microtubule-associated proteins, 665
 Microtubules, 622, 665
 schematic representation of, 665*f*
 Microvesicles, 494
 Microvilli, 484
 Milk (lactose) intolerance, 152, 537, 538
 Mineralocorticoids, 503, 504*f*
 Minerals, 3, 546–563
 digestion and absorption of, 541, 542*f*
 nutrient intake of, 548*t*–549*t*
 Minor groove, in DNA, 361*f*, 362
 Misfolded proteins, accumulation of in endoplasmic reticulum, 620
 Mismatch repair of DNA, 389, 389*t*, 390*f*, 390*t*
 Missense mutations, 417–418, 417*f*
 familial hypertrophic cardiomyopathy caused by, 658, 659*f*
 MIT. *See* Monoiodotyrosine
 Mitchell chemiosmotic theory. *See* Chemiosmotic theory

- Mitochondria
 ALA synthesis in, 324*f*, 325
 apoptosis in, 760–761
 citric acid cycle in, 140–141, 141*f*, 143*f*,
 144–145, 144*f*, 162, 166–167, 166*f*
 fatty acid oxidation in, 223–224, 224*f*
 high-energy phosphate transport from, 135, 135*f*
 involvement in cancer, 738
 ion transport in, 134
 protein synthesis and import by, 608*t*, 610
 respiratory chain in. *See* Respiratory chain
 Mitochondrial cytochrome P450, 123–124,
 584–585. *See also* Cytochrome P450
 system
 Mitochondrial DNA, 378*f*, 378*t*
 Mitochondrial encephalopathy, lactic acidosis, and
 stroke (MELAS), 135
 Mitochondrial genome, 610
 Mitochondrial glycerol-3-phosphate
 dehydrogenase, 121
 Mitochondrial matrix, 610, 611*f*
 Mitochondrial membranes
 enzymes as markers of compartment separated
 by, 127
 protein insertion in, 616
 structure of, 127, 127*f*
 Mitochondrial oxidation of reduced flavins, 566*f*
 Mitochondrial protein complexes, in respiratory
 chain, 120*t*, 127, 128*f*
 Mitochondrial redox damage, 760
 Mitochondrial theory of aging and free radicals, 760
 Mixed-function oxidases, 123, 584. *See also*
 Cytochrome P450 system
 ML. *See* Mucopolidosis
 MOAT. *See* Multispecific organic anion
 transporter
 Modeling, molecular, in protein structure analysis,
 44
 Modifiable risk factors, cancer, 730
 Molecular biology, 30. *See also* Recombinant
 DNA/recombinant DNA technology
 Molecular chaperones. *See* Chaperones
 Molecular diagnostic tests, 3
 Molecular docking programs, 44, 105
 Molecular dynamics, 44
 Molecular genetics, 451–468. *See also*
 Recombinant DNA/recombinant DNA
 technology
 Molecular interaction maps (MIM), 107–108, 108*f*
 Molecular modeling, in protein structure analysis,
 44
 Molecular pathology, 625
 Molecular repair mechanisms, wear and tear
 theory of aging
 enzymatic and chemical mechanisms, 762
 proofreading and repair mechanisms, 762–763
 protein damage, 763
 Molecular replacement, 43
 Molecular switches, 621
 Molybdenum, 562*t*
 Monoacylglycerol acyltransferase, 246, 247*f*
 Monoacylglycerol pathway, 246, 247*f*, 539
 2-Monoacylglycerols, 247*f*
 Monoclonal antibodies, 740*t*
 hybridomas in production of, 684–685, 685*f*
 and therapeutic use in humans, 685
 to VEGF, 736
 Monoclonal immunoglobulin, 739*t*
 Monocytes, 700, 701
 Monoglycosylated core structure, 576
 Monoiodotyrosine, 510
 Monomeric proteins, 41
 Mononucleotides, 340
 “salvage” reactions and, 349*f*, 350
 Monooxygenases, 123. *See also* Cytochrome P450
 system
 Monosaccharides, 152–153, 153–154. *See also*
 specific type and Glucose
 absorption of, 537, 538
 physiologic importance of, 154–155, 155*t*
 Monounsaturated fatty acids, 213, 213*t*. *See also*
 Fatty acids; Unsaturated fatty acids
 dietary, cholesterol levels affected by, 274
 synthesis of, 238–239, 239*f*
 Mortality and aging, 756
 MPO. *See* Myeloperoxidase
 MPS. *See* Mucopolysaccharidoses
 mRNA. *See* Messenger RNA
 mRNA-encoding gene, 459
 MstIII, 452*t*
 in sickle cell disease, 462*f*
 mtDNA. *See* Mitochondrial DNA
 Mucins, properties of, 574*t*
 Mucopolidosis, 639
 Mucopolysaccharides, 157, 159*f*
 Mucopolysaccharidoses, 627, 638, 639*t*
 Mucoproteins, 574. *See also* Glycoproteins
 Multidimensional protein identification
 technology (MudPIT), 34
 Multipass membrane protein, 696
 Multiple deficiency states, vitamin, 546
 Multiple myeloma, 685
 Multiple sclerosis, 250–251
 Multiple sequence alignment, 103, 103*f*
 Multiple sulfatase deficiency, 251
 Multisite phosphorylation, in glycogen
 metabolism, 183
 Multispecific organic anion transporter, 331
 Muscle. *See also* Cardiac muscle; Skeletal
 muscle
 ATP in, 647–648, 657
 contraction of. *See* Muscle contraction
 in energy transduction, 647–649
 in fasting state, 148–149
 fibers in, 648*f*
 glucose uptake into, 148
 glycogen in, 176–178, 177*t*
 in fasting state, 148–149
 metabolism in, 141*f*, 143, 150*t*
 glycogen, 176–178
 lactate production and, 171–172
 phosphorylase in, control of, 179–180
 proteins of. *See* Actin; Myosin; Titin
 striated, 648
 Muscle contraction, 648–649, 651–655
 ATP hydrolysis in, 651, 652*f*
 biochemical events occurring during, 652
 calcium role in, 655
 phosphorylase activation, 180
 sarcoplasmic reticulum, 656
 smooth muscles, 659
 drug affect, 657, 657*f*
 myosin light chain kinase in, 659
 nitric oxide in, 660–661, 662*t*
 regulation of
 actin-based, 653
 calcium in, 653
 relaxation phase of, 652, 653
 sarcoplasmic reticulum and, 653–654
 sliding filament cross-bridge model of,
 648–649
 in smooth muscle, 659, 659*f*, 660–661
 tropomyosin and troponin in, 652–653
 Muscle fatigue, 168
 Muscle fibers, types of, 663*t*
 Muscle phosphorylase
 absence of, 179*t*
 relaxation phase of
 calcium/muscle contraction and, 180
 cAMP and, 181*f*
 Muscle wasting, 620
 Muscular dystrophy, Duchenne, 647, 655
 Mutagenesis, site-directed, in enzyme study, 71
 Mutations, 57–58, 377, 381*f*, 614, 726*t*
 affecting cyclins and CDKs, 731
 base substitution, 416–417, 416*f*
 constitutive, 430
 frameshift, 418–419, 418*f*
 gene conversion and, 380
 integration and, 379–380, 380*f*
 of membrane proteins, diseases caused by, 496,
 496*t*
 missense, 416–417, 417–418, 417*f*
 familial hypertrophic cardiomyopathy caused
 by, 658, 659*f*
 mRNA nucleotide sequence changes causing,
 418*f*
 nonsense, 418–419
 recombination and, 379, 379*f*
 sister chromatid exchanges and, 380, 381*f*
 spontaneous, 724
 suppressor, 418–419
 transition, 416, 416*f*
 transposition and, 380
 transversion, 416, 416*f*
 MYC (oncogene), 728*t*
 Myelodysplasia, 692
 Myelin sheets, 491
 Myelofibrosis, 700
 Myeloid progenitor cells, 701
 Myeloma, 685
 Myeloma cells, hybridomas grown from, 685, 685*f*
 Myeloperoxidase, 704*t*
 in neutrophils, 705
 Myocardial infarction
 enzymes assisting in diagnosis of, 69
 lactate dehydrogenase isoenzymes in diagnosis
 of, 68–69
 markers of, 599
 Myofibrils, 648, 648*f*
 Myoglobin, 58
 oxygen dissociation curve for, 53
 oxygen stored by, 52
 Myoglobinuria, 58
 Myokinase (adenylyl kinase), 117
 in gluconeogenesis regulation, 189
 Myopathy, from inherited mitochondrial defects,
 127
 Myophosphorylase deficiency, 179*t*
 Myosin, 648, 651
 in muscle contraction, 648–649, 651–655

- structure and function of, 648
- Myosin-binding protein C, 658
- Myosin (thick) filaments, 649*f*, 650
- Myosin head, 651, 658
- conformational changes in, in muscle contraction, 651
- Myosin heavy chains, 650–651
- familial hypertrophic cardiomyopathy caused by mutations in gene for, 658
- Myosin light chain kinase, 659
- Myosin light chains, 659
- in smooth muscle contraction, 659
- Myotonia congenita, 658*t*
- Myristic acid, 213*t*
- Myristylation in covalent modification, mass increases and, 31*t*
- N**
- Na. *See* Sodium
- NAD⁺ (nicotinamide adenine dinucleotide), 121, 553
- absorption spectrum of, 67–68, 67*f*
- in citric acid cycle, 167
- as coenzyme, 121, 122*f*, 344*t*
- NAD(P)⁺-dependent dehydrogenases, in enzyme detection, 67–68, 67*f*
- NADH, 174*f*
- absorption spectrum of, 67–68, 67*f*
- extramitochondrial oxidation of, substrate shuttles in, 134, 134*f*–135*f*
- fatty acid oxidation yielding, 225
- in pyruvate dehydrogenase regulation, 173
- NADH dehydrogenase, 121
- NADH-Q oxidoreductase, 127, 128, 128*f*
- as electron acceptor, 127, 128*f*, 163*f*
- NADP⁺ (nicotinamide adenine dinucleotide phosphate), 121, 555*f*
- as coenzyme, 121, 122*f*, 344*t*
- in pentose phosphate pathway, 197*f*, 198, 199*f*
- NADPH
- in cytochrome P450 reactions, 124*f*
- for lipogenesis, 234, 235*f*
- pentose phosphate pathway and, 196, 197*f*, 200
- role in supplying reducing equivalents in blood cells, 693
- transhydrogenase in, 134
- NADPH oxidase, 704*t*
- components of, 704
- mutations in genes for components of, 705
- in resting phagocytic cells, 704
- Na⁺-K⁺-ATPase, 490–491, 491*f*
- in glucose transport, 492, 492*f*
- Nanotechnology, 3, 66
- National Center for Biotechnology Information (NCBI), 102
- Native conformation, protein, 44
- Natural killer cells, 707
- NDPs. *See* Ribonucleoside diphosphates
- Nebulin, 655
- Necrosis vs. apoptosis, 733
- NEFA (nonesterified fatty acids). *See* Free fatty acids
- Negative nitrogen balance, 543
- Negative regulators, of gene expression, 429, 429*t*, 435
- Negative supercoils, DNA, 362
- NEM-sensitive factor, 621*t*, 623
- Neonatal adrenoleukodystrophy, 614, 614*t*
- Neonatal (physiologic) jaundice, 332–333
- Neonatal tyrosinemia, 304
- Neoplasm, 722
- Nephrogenic diabetes insipidus, 490
- Nerve impulses, 491
- Nervous system
- glucose as metabolic necessity for, 146–147
- thiamin deficiency affecting, 555–556
- NESs. *See* Nuclear export signals
- Net charge, of amino acid, 20, 20*f*
- Net diffusion, 486
- NeuAc. *See* N-acetylneuraminic acid
- Neural tube defects, folic acid supplements in prevention of, 560
- Neuraminic acid, 159, 218
- Neuraminidases, 571, 581
- Neurolethyrism, 19
- Neurologic diseases, protein conformation alterations and, 45
- Neurologic impairment, profound, 614
- Neurons, membranes of
- impulses transmitted along, 491
- ion channels in, 488*f*
- Neuropathy, sensory, in vitamin B₆ excess, 558
- Neutral lipids, 212
- Neutrophil extracellular traps, 705–706, 705*f*
- Neutrophils, 700, 701
- adhesion to endothelial cells, 702–703
- body's defense against bacterial infection, 700–701
- enzymes and proteins of, 703, 704*t*
- integrins in, 702–703, 703*t*
- myeloperoxidase in, 705
- in parasite entrapment, 705–706
- proteinases of, 704*t*, 706
- transmigration of, 579
- NF-κB pathway
- inhibition mechanism, 528
- regulation, 528, 529*f*
- Niacin, 556, 557*f*. *See also* Nicotinamide; Nicotinic acid
- deficiency of, 557
- excess/toxicity of, 557
- Nickel, 562*t*
- Nicks/nick-sealing, in DNA replication, 387, 387*f*
- Nick translation, 469
- Nicotinamide, 553
- coenzymes derived from, 62. *See also* Niacin
- dehydrogenases and, 121, 122*f*
- excess/toxicity of, 556
- Nicotinamide adenine dinucleotide (NAD⁺), 121, 556
- absorption spectrum of, 67–68, 67*f*
- in citric acid cycle, 164
- as coenzyme, 121, 122*f*, 344*t*
- Nicotinamide adenine dinucleotide phosphate (NADP⁺), 121, 556
- as coenzyme, 121, 122*f*, 344*t*
- in pentose phosphate pathway, 197*f*, 198, 199*f*
- Nicotinic acid, 556. *See also* Niacin
- as hypolipidemic drug, 275
- NIDDM. *See* Non-insulin-dependent diabetes mellitus
- Niemann-Pick C-like 1 protein, 275
- Niemann-Pick disease, 251*t*
- Night blindness, vitamin A deficiency causing, 188*t*, 546
- Nitric oxide, 647, 660–661, 662*t*, 721*t*
- clotting/thrombosis affected by, 720, 721*t*
- Nitric oxide synthases, 661, 661*t*
- reaction catalyzed by, 314*f*
- Nitrogen balance, 543–544
- Nitroglycerin, 661
- NLS. *See* Nuclear localization signal
- NMR. *See* Nuclear magnetic resonance (NMR) spectroscopy
- NO. *See* Nitric oxide
- Non-clathrin-coated vesicles, 621
- Noncoding regions, in recombinant DNA technology, 460
- Noncoding strand, 360
- Noncompetitive inhibition, competitive, 81–84
- Noncovalent assemblies, in membranes, 479
- Noncovalent forces
- in biomolecule stabilization, 7–8
- peptide conformation and, 23
- Nondeterminant processes, mortality and aging as, 756
- Nonedematous. *See* Marasmus
- Norepinephrine, biosynthesis of, 509, 509*f*, 510
- Nonequilibrium reactions, 145
- citric acid cycle regulation and, 167
- glycolysis regulation and, 172, 185–187
- Nonesterified fatty acids. *See* Free fatty acids
- Nonheme iron, 673
- Nonhistone proteins, 371
- Nonhomologous end-joining of DNA, 389, 390*f*
- Non-insulin-dependent diabetes mellitus, 193–194
- Nonoxidative phase, of pentose phosphate pathway, 198
- Nonrepetitive (unique-sequence) DNA, 377
- Nonsense codons, 414, 417
- Nonsense mutations, 418–419
- Nonsteroidal anti-inflammatory drugs
- cyclooxygenase affected by, 240
- prostaglandins synthesis, 232, 240
- Non template strand DNA, 395
- Norepinephrine. *See also* Catecholamines
- synthesis of, 317, 320*f*
- in thermogenesis, 264, 264*f*
- Northern blot transfer procedure, 362
- NPCs. *See* Nuclear pore complexes
- NRAMP 1, 672
- NSAID. *See* Nonsteroidal anti-inflammatory drugs
- NSF. *See* NEM-sensitive factor
- Nuclear export signals, 612
- Nuclear factor kappa-B (NFκB), 671
- Nuclear genes, proteins encoded by, 610
- Nuclear localization signal, 608*t*, 611–612, 612*f*
- Nuclear magnetic resonance (NMR) spectroscopy, 43–44
- Nuclear pore complexes, 611
- Nuclear proteins, 573
- Nuclear receptor coregulators
- mammalian coregulator proteins, 532*t*

- and transcription, 530–533
- Nuclear receptors, 500
with special ligands, 531*t*
- Nuclear receptor superfamily, 530, 531*f*
structural features, 530
- Nuclear RNA processing, 447–448
- Nucleases, 9, 368
active chromatin and, 374
bases of, 340, 341*t*
dietarily nonessential, 348
digestion of, 368
- Nucleic acids. *See* DNA; RNA
- Nucleolytic processing, of RNA, 409
- Nucleophile, water as, 9–10
- Nucleoplasm, 612*f*
- Nucleoproteins, packing of, 375, 375*t*
- Nucleosidases (nucleoside phosphorylases),
purine, deficiency of, 355
- Nucleoside diphosphate kinase, 118
- Nucleosides, 340–343, 341*t*
- Nucleoside triphosphates
group transfer potential of, 343, 344*t*
nonhydrolyzable analogs of, 344, 345*f*
in phosphorylation, 118
in transfer of high-energy phosphate, 118
- Nucleosomes, 371–373, 372*f*, 403–404
- Nucleotide bending fold. *See* Rossmann fold
- Nucleotide excision-repair of DNA, 390*f*
- Nucleotides, 339–346, 340–343, 341*t*, 414, 414*t*
adenyllyl kinase in interconversion of, 118
as coenzymes, 344*t*
metabolism of, 347–357
in mRNA. *See* Purine; Pyrimidines/pyrimidine
nucleotides
mutations caused by changes in, 416*f*, 417–418,
417*f*, 418–419, 418*f*
physiologic functions of, 343
as polyfunctional acids, 342
polynucleotides, 344–345
synthetic analogs of, in chemotherapy, 343–344,
345*f*
ultraviolet light absorbed by, 342–343
- Nucleotide sugars, 571, 574
- Nucleus of cell, importins and exportins in, 609*f*,
612
- Nutrigenomics, 3
- Nutrition, 537–544. *See also* Diet
biochemical research affecting, 3
lipogenesis regulated by, 236
- Nutritional deficiencies, 537
in AIDS and cancer, 543
- Nutritionally essential amino acids, 141, 282, 544.
See also Amino acids
- Nutritionally essential fatty acids, 238, 282*t*. *See also* Fatty acids
abnormal metabolism of, 241
deficiency of, 239, 241
- Nutritionally nonessential amino acids, 141, 281,
282*t*, 544
synthesis of, 282–286
- O**
- Obesity, 113, 140, 254, 537, 541
lipogenesis and, 232
in relation to cancer, 742
- Octamers, histone, 372*f*, 373
- Oculocerebrorenal syndrome, 619*t*
- O gene, 697–698
- O-glycosidic linkage, 573, 628
- O-Glycosylation, features of, 574*t*
- 1,25(OH)₂-D₃. *See* Calcitriol (1,25[OH]₂-D₃)
- Okazaki fragments, 382*t*, 383, 385, 385*f*
- Oleic acid, 212, 212*f*, 213*t*, 215*f*
- Oligomers, import of by peroxisomes, 612
- Oligomycin, on oxidation and phosphorylation,
132, 132*f*
- Oligonucleotide
definition of, 469
in primary structure determination, 31
- Oligonucleotide synthesis, 457–458
- Oligosaccharide chains, 670
- Oligosaccharide processing, 577, 608
Golgi apparatus in, 608
- Oligosaccharides, 153
membrane-bound and circulating, 574
O-linked, structures of, 573*f*
structures of, 575*f*
- O-linkage, 573*f*
- OMP (orotidine monophosphate), 353*f*
- Oncogenes, 2–3
cyclins and, 389
definition, 726
mechanisms of activating, 726, 726*t*
properties of, 728*t*
protein products role in cancer development,
726–727, 728*f*
role in colorectal cancer development, 728–730,
729*f*
and tumor suppressor genes, difference
between, 728*t*
tumor viruses, 727
- Oncogenic viruses, 724, 724*f*
- Oncoproteins, Rb protein and, 389
- Oncotic (osmotic) pressure, 669
- Oncoviruses, cyclins and, 389
- Online Mendelian Inheritance In Man database,
102
- Operator locus, 430*f*, 431
- Operon/operon hypothesis, 430–433, 430*f*
- Opsonization, 703
- Optical activity/isomer, 153–154
- OR. *See* Right operator
- ORC. *See* Origin replication complex
- ORE. *See* Origin replication element
- Organ function tests
adrenal function tests, 599
liver function tests, 596*t*, 597–598, 598*t*
renal function tests, 596–597, 596*t*
thyroid function tests, 598–599
- Origin of replication (ori), 381–382, 382*f*, 468
- Origin replication complex, 382
- Origin replication element, 381
- Ornithine, 19*t*, 314
catabolism of, 299, 301*f*
metabolism of, 317*f*
in urea synthesis, 292, 294
- Ornithine-citrulline antiporter, defective, 299
- Ornithine- δ -aminotransferase, 300*t*
- Ornithine transcarbamoylase/L-ornithine
transcarbamoylase deficiency of, 295, 295*t*,
356
in urea synthesis, 294
- Orotate phosphoribosyltransferase, 353*f*, 354,
356
- Orotic aciduria, 356–357
- Orotidine monophosphate (OMP), 353*f*
- Orotidinuria, 357
- Osmotic (oncotic) pressure, 669
- Osteoarthritis, 627, 640
- Osteoblasts, 641*f*, 642
- Osteocalcin, 562
- Osteoclasts, 640
in bone resorption, 641*f*
- Osteogenesis imperfecta (brittle bones), 282, 642
- Osteomalacia, 553
- Osteopetrosis (marble bone disease), 642–643
- Osteoporosis, 553, 643
- Ouabain, 156, 491
Na⁺-K⁺-ATPase affected by, 491
- Outer mitochondrial membrane, 127, 610
protein insertion in, 610
- Ovarian steroidogenesis, 505, 507, 507*f*, 508*f*
- Overflow proteinuria, 597*t*
- Oxaloacetate
in amino acid carbon skeleton catabolism,
298–299, 298*f*, 299*f*
in aspartate synthesis, 283, 283*f*
in citric acid cycle, 144, 144*f*, 161–162, 162*f*,
165, 165*f*, 166
- Oxidants, 694
- Oxidases, 120, 120*f*. *See also* specific type
flavoproteins as, 120, 121*f*
mixed-function, 123. *See also* Cytochrome P450
system
- Oxidation, 119
definition of, 119
dehydrogenases in, 120–122, 122*f*
fatty acid, 223–226. *See also* Ketogenesis
acetyl-CoA release and, 141, 141*f*, 224–226,
224*f*, 225*f*
clinical aspects of, 231
hypoglycemia caused by impairment of, 231
in mitochondria, 223–224, 224*f*
hydroperoxidases in, 122
oxidases in, 120, 120*f*, 122*f*
oxygenases in, 123, 123*f*, 124*f*
oxygen toxicity and, 124–125
redox potential and, 119, 120*t*
- Oxidation-reduction potential, 119, 120*t*
- Oxidative deamination, 292*f*
- Oxidative decarboxylation, 163
- Oxidative phase, of pentose phosphate pathway,
197*f*, 198, 199*f*
- Oxidative phosphorylation, 116, 127, 140, 662. *See also* Phosphorylation, protein; Respiratory
chain
ATP generation by, 130
enzymes as markers of compartments separated
by mitochondrial membranes in, 127
at respiratory chain level, 130, 169*t*
- Oxidative stress, 724
reactions in blood cells, 693
- Oxidoreductase, 40, 127, 128*f*
NADH-Q, 127, 128*f*
as electron acceptor, 127, 128*f*, 163*f*
- Oxidoreductases, 61, 120. *See also* specific type
- Oxidosqualene:lanosterol cyclase, 268, 269*f*
- Oxygen
binding, 53*f*, 55. *See also* Oxygenation
Bohr effect and, 56, 57*f*
histidines F8 and E7 in, 52, 52*f*

- debt, 172
hemoglobin affinities (P50) for, 55
myoglobin in storage of, 52–53
transport of, ferrous iron in, 52–53
- Oxygenases, 119, 123–124
- Oxygenation of hemoglobin
conformational changes and, 55–56
apoprotein, 55
2,3-bisphosphoglycerate stabilizing, 57f
high altitude adaptation and, 57
mutant hemoglobins and, 57–58
- Oxygen dissociation curve, for myoglobin and hemoglobin, 53
- Oxygen toxicity, superoxide free radical and, 124.
See also Free radicals
- Oxysterols, 220
- P**
- p97, 619
- P53 (tumor suppressor gene), 728t
- PAC (P1-based) vector, 455
- Paddle, charged, 488f, 489, 490f
- PAF. *See* Platelet-activating factor
- Pain, prostaglandins in, 232
- Palindrome, 469
- Palmitate, 233
- Palmitic acid, 213t
- Palmitoleic acid, 213t, 238f
synthesis of, 238
- Palmitoylation, in covalent modification, mass increases and, 31t
- Pancreatic carcinomas, 733
- Pancreatic insufficiency, in vitamin B₁₂ deficiency, 558
- Pancreatic islets, insulin produced by, 192
- Pancreatic lipase, 539
- Panprotease inhibitor, 680
- Pantothenic acid, 233, 561, 561f
in citric acid cycle, 164
coenzymes derived from, 62
- Papain, immunoglobulin digestion by, 681
- PAPS. *See* Adenosine 3'-phosphate-5'-phosphosulfate
- Paracrine signaling, 706
- Parallel beta sheet, 39
- Paramecia, 703
- Parasitic infections, 694
- Parathyroid hormone, 512–513
biosynthesis of, 512–513
in storage vesicles, 515
- Paroxysmal nocturnal hemoglobinuria, 496t, 580, 693t, 694
- Passive diffusion/transport, 485, 485f, 485t, 486f, 487
- P bodies, 425f, 426, 447
- pBR322, 455, 456f
- P component, in amyloidosis, 680
- PCR. *See* Polymerase chain reaction
- P450 cytochrome. *See* Cytochrome P450 system
- PDGF. *See* Platelet-derived growth factor
- PDH. *See* Pyruvate dehydrogenase
- Pectin, 157, 158f
- Pedigree analysis for sickle cell disease, 462–463
- Pellagra, 546, 557
- Penicillamine, for Wilson disease, 676
- Pentasaccharide core, 575f
- Pentose phosphate pathway, 140, 196–206, 197f, 199f, 200f
cytosol as location for reactions of, 198–200
enzymes of, 188t
erythrocyte hemolysis and, 204–205
impairment of, 204–205
NADPH produced by, 196, 197f, 199f
for lipogenesis, 234, 234f, 235f
nonoxidative phase of, 198
oxidative phase of, 197f, 198, 199f
ribose produced by, 197f, 200
- Pentoses, 152, 153t, 154–155, 155t
in glycoproteins, 159t
- Pentosuria, essential, 196, 205
physiologic importance of, 154–155, 155t
- PEPCK. *See* Phosphoenolpyruvate carboxykinase
- Pepsin, 539
in acid-base catalysis, 64
- Pepsinogen, 539
- Peptic ulcers, 581, 599
- Peptidases, in protein degradation, 288–289, 288f
- Peptide bonds, 23. *See also* Peptides
formation of, 9, 422
hydrolysis of, 756–757
partial double-bond character of, 23, 23f
on secondary conformations, 37–38, 37f
- Peptide hormone receptors, 500
- Peptide precursors, hormone synthesis from, 511
- Peptides, 23, 502f. *See also* Amino acids
- Peptidylarginine deiminase, 705–706, 705f
- Peptidylglycine hydroxylase, vitamin C as coenzyme for, 562
- Peptidyl prolyl isomerase, 618
- Peptidyltransferase, 422, 423t
- Perilipin, 263–264
- Periodic paralysis
hyperkalemic, 658t
hypokalemic, 658t
- Peripheral cytoskeletal proteins, 695t, 696
- Peripheral proteins, 482, 483f
- Permeability coefficients, of substances in lipid bilayer, 481f
- Pernicious anemia, 546, 559
- Peroxidases, 122, 239
- Peroxidation
lipid, free radicals produced by, 219–220, 220f
of unsaturated lipids, 759f
- Peroxides, 567
- Peroxins, 614
- Peroxisomal abnormalities, disorders due to, 608t, 625
- Peroxisomal enzymes, 614
- Peroxisomal-matrix targeting sequences, 608t, 613, 613f
- Peroxisomes, 123, 613
absence/abnormalities of, 614, 614t
in Zellweger syndrome, 231, 614
biogenesis of, 614
in fatty acid oxidation, 226
- PFK-1. *See* Phosphofructokinase (phosphofructokinase-1)
- PGHS. *See* Prostaglandin H synthase
- PGIs. *See* Prostaglandins
- PGs. *See* Prostaglandins
- pH, 10–13. *See also* Acid-base balance
- amino acid net charge and, 20–21, 21f
buffering and, 12–13. *See also* Buffers
calculation of, 10–11
definition of, 10
enzyme-catalyzed reaction rate affected by, 77
isoelectric, amino acid net charge and, 20–21
- Phage lambda, 433–437, 433f, 436f
- Phages, in recombinant DNA technology, 455
- Phagocytic cells
proteases derived from, 706
respiratory burst of, 704
- Phagocytosis, 492, 700, 701, 703–705, 703f
- Phagosomes, 703
- Pharmacogenomics, 3, 102
- Phasing, nucleosome, 373
- P₅₀, hemoglobin affinity for oxygen and, 55
- Phenylalanine, 17t
catabolism of, 304, 306, 306f
in phenylketonuria, 304, 306f
requirements for, 544
in tyrosine synthesis, 285, 285f
- Phenylalanine hydroxylase, 43f, 300t
defect in, 304
in tyrosine synthesis, 285, 285f
- Phenylethanolamine-N-methyltransferase (PNMT) in catecholamine biosynthesis, 510
- Phenylisothiocyanate (Edman reagent), in protein sequencing, 29, 30f
- Phenylketonuria, 304
- Phi angle, 37
- Phosphagens, 117
- Phosphatase cascade, 501t
- Phosphatases
acid, diagnostic significance of, 68t
alkaline
isozymes of, diagnostic significance of, 68t
in recombinant DNA technology, 453t
- Phosphates/phosphorus, 557
in extracellular and intracellular fluid, 478t
free energy of hydrolysis of, 115–116, 116t
high-energy, 115. *See also* ATP
in energy capture and transfer, 115–116, 116t
as “energy currency” of cell, 116–117, 131
symbol designating, 115
low-energy, 115
- Phosphate transporter, 134, 134f
- Phosphatidate, 246, 246f
in triacylglycerol synthesis, 246, 247f
- Phosphatidate phosphohydrolase, 246, 247f
- Phosphatidic acid, 215, 216f, 479, 479f
- Phosphatidic acid pathway, 539
- Phosphatidylcholines (lecithins), 216, 216f
membrane asymmetry and, 482
metabolism of, 249f
synthesis of, 246, 246f
- Phosphatidylethanolamine (cephalin), 216, 216f
membrane asymmetry and, 482
synthesis of, 246, 247f
- Phosphatidylglycerol, 216f, 217
- Phosphatidylinositolide metabolism and calcium-dependent hormone action, 525–526
- Phosphatidylinositol 4,5-bisphosphate (PIP₂), 216
in platelet activation, 719f, 720

- Phosphatidylinositol/phosphatidylinositide, 216, 216f
 as second messenger/second messenger precursor, 216, 216f
 synthesis of, 246f, 248
- Phosphatidylinositols, 501t
- Phosphatidylserine, 216, 216f, 246
 membrane asymmetry and, 482
- Phosphocreatine, in muscle, 647–648
- Phosphodiesterases, 345, 523
 cAMP hydrolyzed by, 179
- Phosphodiester bonds, 344–345
- Phosphoenolpyruvate, 185–186
 free energy of hydrolysis of, 116t
 in gluconeogenesis, 164, 165f
- Phosphoenolpyruvate carboxykinase, 164, 165f
 in gluconeogenesis regulation, 164, 165f, 185–186, 186f
- Phosphoenolpyruvate carboxylase, 188t
 in gluconeogenesis, 188t
- Phosphofructokinase (phosphofructokinase-1), 188t
 in gluconeogenesis regulation, 189
 in glycolysis, 170, 170f, 188t
 regulation and, 172
 muscle, deficiency of, 174, 179t
- Phosphoglucomutase, 176
 in glycogen biosynthesis, 177f, 201f
- 6-Phosphogluconate dehydrogenase, 197f, 198, 199f
- 3-Phosphoglycerate
 in glycolysis, 170f, 172
 in serine synthesis, 283, 284f
- Phosphoglycerate kinase, in glycolysis, 170–171, 170f
 in erythrocytes, 172, 172f
- Phosphoglycerate mutase, in glycolysis, 170f, 171
- Phosphoglycerides, in membranes, 479, 479f
- Phosphoglycerols
 lysophospholipids in metabolism of, 216, 217f
 synthesis of, 246, 246f
- Phosphohexose isomerase, in glycolysis, 170, 170f
- Phospholipase A₁, 249, 249f
- Phospholipase A₂, 248f, 249, 249f
 in platelet activation, 719f, 720
- Phospholipase C (PLC), 249, 249f, 702
 activation and hormone-receptor interactions, 525f
 PIP₂ cleavage by, 526f
- Phospholipases
 in phosphoglycerol degradation and remodeling, 249, 249f
 phospholipase D, 249, 249f
- Phospholipids, 212, 253, 254
 digestion and absorption of, 538–539
 glycerol ether, synthesis of, 248–249, 248f
 in lipoprotein lipase activity, 257
 in membranes, 215–217, 217f, 479, 479f, 481, 624
 membrane asymmetry and, 624
 in multiple sclerosis, 250–251
 as second messenger precursors, 245
 synthesis of, 247f
- Phosphoprotein phosphatases, 523–524
- Phosphoproteins, 523
- Phosphoric acid, pK/pK_a value of, 13t
- Phosphorus. *See* Phosphates/phosphorus
- Phosphorylase
 activation of, cAMP and, 180
 calcium/muscle contraction and, 180
 cAMP and, 181f
 in glycogen metabolism, 177f, 179–180
 regulation of, 180, 183f
 liver, 179–180
 deficiency of, 179t
 muscle, 179–180
 absence of, 179t
 phosphorylase a, 180, 181f
 phosphorylase b, 180, 181f
- Phosphorylase kinase
 calcium/calmodulin-sensitive, in glycogenolysis, 180
 deficiency of, 179t
 phosphorylase kinase a, 180, 181f
 phosphorylase kinase b, 180, 181f
 protein phosphatase-1 affecting, 180
- Phosphorylation, protein
 in covalent modification, 92, 93f, 94t
 mass increases and, 31t
 multisite, in glycogen metabolism, 183
 oxidative. *See* Oxidative phosphorylation
 at substrate level, 131, 131f
 versatility of, 94–95, 94t, 95f
- Phosphotriose isomerase, 170
- Photosensitivity, in porphyria, 329
- Phototherapy, cancer, porphyrins in, 327
- p*-Hydroxyphenylpyruvate hydroxylase, 300t
- p*-Hydroxyphenylpyruvate, in tyrosine catabolism, 304, 305f
- Phylloquinone, 550t, 554, 554f. *See also* Vitamin K
- Physiologic (neonatal) jaundice, 332–333
- Phytanic acid, Refsum disease caused by
 accumulation of, 231
- Phytase, 541
- Phytic acid (inositol hexaphosphate), calcium
 absorption affected by, 541
- Pi, 679
 in muscle contraction, 652, 662f
 pI (isoelectric pH), amino acid net charge and, 20–21
- PIC. *See* Preinitiation complex
- “Ping-Pong” mechanism, in facilitated diffusion, 487, 488f
- Ping-pong reactions, 84, 85f
- Pinocytosis, 492–493, 492f
- PIP₂ (phosphatidylinositol 4,5-bisphosphate), 216
 in absorptive pinocytosis, 493
 in platelet activation, 719f, 720
- PI-phospholipase C (PI-PLC), 573
- Pituitary hormones. *See also* specific type
 blood glucose affected by, 192
- PKA. *See* Protein kinase A
- pK/pK_a, 20–21
 of amino acids, 16t–17t, 20, 20f
 environment affecting, 21
 medium affecting, 13
 of weak acids, 11–12, 20
- PKU. *See* Phenylketonuria
- Plasma, 669
 analysis of enzymes in, 68–69
- Plasma cells, 707
- Plasma enzymes. *See also* Enzymes
 diagnostic significance of, 68–69
- Plasma lipoproteins. *See* Lipoproteins
- Plasmalogens, 217, 217f, 248, 248f
 biosynthesis of, 248f
- Plasma membrane, 477–496, 624. *See also* Membranes
 carbohydrates in, 159
 mutations in, diseases caused by, 496, 496t
- Plasma proteins, 569, 668–687, 672t. *See also* Glycoproteins; specific type
 concentration of, 674
 electrophoresis for analysis of, 669
 functions of, 672t
 half-life of, 671
 polymorphism of, 670–671
 synthesis in liver, 143, 670
 transport, 672t
- Plasma thromboplastin antecedent, 712f, 713, 713t
 deficiency of, 714
- Plasma thromboplastin component, 712, 712f, 713, 713t
 coumarin drugs affecting, 717
 deficiency of, 718
- Plasmids, 455, 456f, 469
- Plasmin, fibrin clots dissolved by, 718, 718f
- Plasminogen, 718
 activators of, 69, 718f, 721t
- Platelet-activating factor, 245
 synthesis of, 246f, 248, 248f
- Platelet-derived growth factor, 730
- Platelets
 activation/aggregation of, 711, 719–720, 719f
 aspirin affecting, 720–721
 aggregation, 721
 contain mitochondria, lack nucleus, 698
 disorders of, 698
 integrins in, 702–703, 703t
- PLC (phospholipase C)
 activation and hormone-receptor interactions, 525f
 PIP₂ cleavage by, 526f
- Pleckstrin, in platelet activation, 720
- PLP. *See* Pyridoxal phosphate
- pOH, in pH calculation, 10
- Point mutations, 416, 460, 726
- Polarity, DNA, 360
- Polarity of protein synthesis, 419
- Polar metabolites, 583
- Polyacrylamide gel electrophoresis, for protein/
 peptide purification, 28–29
- Polyamines, synthesis of, 316, 318f
- Polyanions, 636
- Polycistronic mRNA, 430
- Polycomb repressive complex 2 (PRC2), 438
- Polycythemia, 58
- Polyelectrolytes, peptides as, 23
- Polyfunctional acids, nucleotides as, 342
- Polyisoprenoids, in cholesterol synthesis, 268f, 269
- Polymerase chain reaction, 70, 458–459, 459f
 in microsatellite repeat sequence detection, 378
- Polymerases
 DNA, 381, 382f, 383
 prokaryotic and eukaryotic, 383t
 in recombinant DNA technology, 453t

- RNA, DNA-dependent, in RNA synthesis, 395–396
- Polymorphisms
 microsatellite, 378
 microsatellite DNA, 463–464
 plasma protein, 670–671
 restriction fragment length. *See* Restriction
- Polymorphonuclear leukocytes, 701
- Poly-*N*-acetylglucosamine chains, 575
- Polynucleotide kinase, in recombinant DNA technology, 453*t*
- Polynucleotides, 344–345
 posttranslational modification of, 345
- Polyol (sorbitol) pathway, 205
- Polypeptides
 protein synthesis on, 26*f*
 Sanger' determination of, 29
- Polyphosphoinositide pathway, platelet activation and, 720
- Poly(A) polymerase, 409
- Polyprenoids, 219, 220*f*
- Polyribosomes, 424–425, 608
 protein synthesis on, 608*f*, 609*f*, 610, 614
 signal hypothesis of binding of, 609*f*, 614–616, 614*t*
- Polysaccharides, 153, 156–159, 159*f*. *See also* specific type
- Polysomes, 367. *See also* Polyribosomes
- Poly(A) tail of mRNA, 365, 409
 in initiation of protein synthesis, 421
- Polytene chromosomes, 374, 374*f*
- Polyubiquitinated target protein, 620
- Polyunsaturated fatty acids, 213, 213*t*. *See also*
 Fatty acids; Unsaturated fatty acids
 dietary, cholesterol levels affected by, 274
 eicosanoids formed from, 239, 240*f*, 241*f*
 essential, 238, 238*f*
 synthesis of, 239, 239*f*
- POMC. *See* Pro-opiomelanocortin (POMC)
 peptide family
- POMC gene, 514–515, 515*f*
- Pompe disease, 179*t*
- Porcine stress syndrome, 654
- Porphobilinogen, 325, 325*f*, 326*f*
- Porphyrias, 323, 329–330, 329*f*
 biochemical causes of signs and symptoms of, 329*f*
 major findings in, 328*t*
- Porphyrinogens, 326
 accumulation in porphyria, 329
- Porphyrins, 323–335, 324*f*
 absorption spectra of, 327, 328*f*
 heme synthesis and, 324*f*, 325–327, 326*f*, 328*f*
 reduced, 326
 spectrophotometry for detection of, 327–329
- Positive nitrogen balance, 543
- Positive regulators, of gene expression, 429, 429*t*, 433, 435
- Posthepatic jaundice, 333*f*
- Postrenal proteinuria, 597*t*
- Post-translational modifications, 16
 of amino acids, 18, 18*f*
 of histones, 735
- Posttranslational processing, 46–47, 426
 in membrane assembly, 616, 616*f*
- Posttranslational translocation, 616, 616*f*
- Potassium, 562*t*
 in extracellular and intracellular fluid, 478, 478*t*
 permeability coefficient of, 481*f*
- Potential energy function, 105
- Power stroke, 652
- PPI. *See* Peptidyl prolyl isomerase
- PPI. *See* Pyrophosphate
- p53 protein, 392, 731, 733
- PR. *See* Progesterone
- Prasugrel, 721
- Pravastatin, 275
- Precision, laboratory (lab) tests, 591, 591*f*
- Predictive value of lab tests, 593
- Pregnancy
 fatty liver of, 231
 hypoglycemia during, 193
 iron needs during, 676
- Pregnancy toxemia of ewes
 fatty liver and, 261
 ketosis in, 231
- Pregnenolone to testosterone, conversion of, 505
- Prehepatic jaundice, 333*f*
- Preinitiation complex, 397
 in protein synthesis, 419, 420*f*
- Prekallikrein, 712*f*, 713
- Premature termination, 417
- Premenstrual syndrome, vitamin B₆ in
 management of, sensory neuropathy and, 558
- Preprocollagen, 629
- Prehormone, 512
- Preproprotein, albumin synthesized as, 671
- PreproPTH, 512
- Preproteins, 608
- Presequence. *See* Signal peptide
- Preventive medicine, biochemical research
 affecting, 3
- Primaquine, 694, 747–748
- Primaquine-sensitive hemolytic anemia, 694
- Primary amyloidosis, 680
- Primary structure, 30, 37. *See also* Protein
 sequencing
 amino acid sequence determining, 22
 Edman reaction in determination of, 30, 31
 genomics in analysis of, 33
 molecular biology in determination of, 30
 of polynucleotides, 345
 proteomics and, 33–34
 Sanger' technique in determination of, 29
- Primary transcripts, 396, 409
- Primases, DNA, 382*f*
- pri-miRNAs. *See* Primary transcripts
- Primosome, 383, 469
- Prion diseases (transmissible spongiform
 encephalopathies), 45–46
- Prion-related protein, 46
- Prions, 45–46
- Proaccelerin (factor V), 712*f*, 713*t*, 714, 714*t*
- Proalbumin, 623
- Proaminopeptidase, 539
- Procarcinogens, 584
- Procaspases, 733
- Prochymotrypsin, activation of, 93, 93*f*
- Procollagen, 426, 562
- Procollagen aminoproteinase, 630
- Procollagen carboxyproteinase, 630
- Procollagen molecule hydroxylysines,
 glycosylation of, 629
- Proconvertin (factor VII), 712, 712*f*, 713*t*, 714*t*
 coumarin drugs affecting, 717
- Prodrugs, 85, 584
 metabolic transformation of, 85
- Proelastase, 539
- Proenzymes, 92–93
- Profiling, protein, RNA transcript and, 465
- Progesterone, 508*f*
- Prohormones, 426
- Proinflammatory molecules, 579
- Proinsulin, 512
 structure of, 512*f*
- Prokaryotic gene expression. *See also* Gene
 expression
 as model for study, 430
 unique features of, 430
- Proline, 17*t*
 accumulation of, 299, 300*t*, 301*f*
 catabolism of, 299
 hydroxylation of, 628
 metabolism of, 314*f*
 synthesis of, 284, 284*f*
- Proline-cis, trans-isomerase, protein folding and,
 45, 45*f*
- Proline dehydrogenase, 300*t*
 block of proline catabolism at, 299
- Proline hydroxylase, vitamin C as coenzyme for,
 562
- Prolyl hydroxylase, 628, 631
- Prolyl hydroxylase reaction, 285, 285*f*
- Promoter clearance, 398
- Promoter insertion, 726, 726*t*, 727*f*
- Promoter recognition specificity, 397
- Promoters, in transcription, 396, 399*f*
 eukaryotic, 400*f*
- Promoter site, in operon model, 430*f*, 431
- Pro-opiomelanocortin (POMC) peptide family,
 514–515, 515*f*. *See also* specific type
- Pro-oxidants, 568–569, 568*t*, 694. *See also* Free
 radicals
- Prophage state, 434
- Propionate
 blood glucose and, 190
 in gluconeogenesis, 186*f*
 metabolism of, 185, 750*t*
- Propionyl-CoA
 fatty acid oxidation yielding, 225
 methionine in formation of, 308, 309*f*
- Propionyl-CoA carboxylase, 187, 187*f*
- Proproteins, 46, 92, 426
- proPTH, 512
- Propyl gallate, as antioxidant/food preservative,
 221
- Prostacyclins, 213
 clinical significance of, 242
 clotting/thrombosis affected by, 719*f*, 720, 721*t*
- Prostaglandin E₂, 213, 214*f*
- Prostaglandin H synthase, 239
- Prostaglandins, 213, 214*f*, 232, 239, 706
 cyclooxygenase pathway in synthesis of,
 240–241, 241*f*, 242*f*
- Prostanoids, 213
 clinical significance of, 242
 cyclooxygenase pathway in synthesis of,
 240–241, 241*f*, 242*f*

- Prostate-specific antigen, 739*t*, 740
- Prosthetic groups, 61–62
in catalysis, 61–62
- Protamine, 717
- Proteases/proteinases, 9, 288*f*, 289*f*, 539, 574.
See also specific type
cleaving synaptobrevin, 623
phagocyte-derived, 706
in protein degradation, 288–289
rennin, 60–61
- Proteasomes, 288, 289*f*, 616
degradation in, 619
misfolded proteins in, 620
ubiquitination in, 620, 620*f*
- Protein acetylation, 94
- Proteinases
and ECM, 736
of neutrophils, 704*t*, 706
- Protein C, in blood coagulation, 714*t*, 717
- Protein-conducting channel, 615
- Protein damage, repairing of, 763
- Protein Database, 101
- Protein degradation
ATP and ubiquitin dependent, 288–289
ATP-independent, 288
- Protein degradation, ubiquitin in, 620, 620*f*
- Protein disulfide isomerase, protein folding and, 45
- Protein-DNA interactions, bacteriophage lambda
as paradigm for, 433–437, 433*f*, 436*f*
- Protein folding, 26*f*, 44–45
chaperones and, 608–610, 618–620, 618*t*
degradation of, 618–619, 619*f*
misfolding in, 618–619
ubiquitination in, 620, 620*f*
- Protein genes *s36* and *s38*, chorion, 448*f*
- Protein kinase A, 522–523
- Protein kinase C, 719*f*, 720
- Protein kinases, 92–93
cAMP-dependent/cAMP-independent, 522–523
in glycogen metabolism, 179–180, 181*f*, 182–183, 183*f*
in hormonal regulation of lipolysis, 263, 263*f*
in initiation of protein synthesis, 419
protein kinase A (PKA) and cAMP, 522–523
protein kinase C (PKC) in platelet activation, 719*f*, 720
in protein phosphorylation, 93, 93*f*, 95*f*
- Protein-losing gastroenteropathy, 671
- Protein misfolding
accumulation in endoplasmic reticulum in, 618–619
endoplasmic reticulum-associated degradation of, 618–620, 619*f*
ubiquitination in, 620, 620*f*
- Protein phosphatase-1, 181*f*, 183*f*
glycogen phosphorylase and, 182
- Protein phosphatases, 95*f*. *See also* Phosphatases
- Protein phosphorylation. *See* Phosphorylation, protein
- Protein prenylation, 270
- Protein profiling, RNA transcript and, 465
- Protein-protein cross-links and protein glycation, 762*f*
- Protein-RNA complexes, in initiation, 419–421
- Proteins, 421*f*. *See also* Peptides; specific type
absorption of, 539, 541
acute phase, 671, 672*t*
negative, vitamin A as, 551
amino acids in, 23*f*
asymmetry of, membrane assembly and, 624, 624*f*
auxiliary, in folding, 45
catabolism of, 287–296
configuration of, 36
conformation of, 36
peptide bonds affecting, 23
degradation of
to amino acids, 288–289, 288*f*, 289*f*
protein refolding and, 45
temperature and, 77–78
dietary
digestion and absorption of, 539
metabolism of, in fed state, 148
requirements for, 543–544
dimeric, 41
domains of, 41, 42*f*
in extracellular and intracellular fluid, 478, 478*t*
fibrous, 37, 46
collagen as, 46
function of, bioinformatics in identification of, 34
fusion, in enzyme study, 70
globular, 37
identification, by homology, 102–103
import of, by mitochondria, 610, 611*t*
ion channels as transmembrane, 487–489, 488*f*, 489*t*
L-amino acids in, 19
life cycle of, 26*f*
to lipid rasion in membrane, 478–479
loss of in trauma/infection, 544
in membranes, 481, 489*t*. *See also* Glycoproteins; Membrane proteins
ratio to lipids, 478*f*
modular principles in construction of, 37
monomeric, 41
of neutrophils, 703
order of the structure, 37
phosphorylation of, 92–93, 93*f*, 94*t*. *See also* Phosphorylation, protein
as polyelectrolytes, 23
posttranslational modification of, 46, 426
prenylation, 270
purification of, 26–29
reactions with ROS, 759*f*
receptors as, 493
relating three-dimensional structure to function, 103–104, 104*f*
sequences or molecules directing, 608*t*
soluble, 37
structure of, 37–41
cryo-electron microscopy, 44
folding and, 44–45
higher orders of, 36–47
molecular modeling and, 44
primary, 25–34, 37. *See also* Primary prion diseases associated with alteration of, 45–46
quaternary, 37
secondary, 37–41
supersecondary, 39
tertiary, 39–41
x-ray crystallography in analysis of, 41–43
synthesis of, 148, 413–427. *See also* Protein sorting
elongation in, 423*f*
environmental threats affecting, 425
in fed state, 148
genetic code/RNA and, 363–364, 413–415. *See also* Genetic code
inhibition of by antibiotics, 426–427, 427*f*
initiation of, 419, 420*f*, 422*f*
by mitochondria, 608*t*, 610
modular principles in, 37
polysomes in, 424–425, 608, 608*f*
posttranslational processing and, 426
recognition and attachment in, 416*f*
in ribosomes, 144*f*, 145
termination of, 423
translocation and, 422–423
viruses affecting, 425, 426*f*
targeting, to matrix, 610
translocation of, 26*f*
unknown, identification of, 103–105
- Protein sequencing
Edman reaction in, 29–30, 30*f*
genomics and, 33
mass spectrometry in, 31, 31*t*, 32*f*
molecular biology in, 30
peptide purification for, 26–29
proteomics and, 33–34
purification for, 26–29, 29*f*
Sanger' method of, 29
- Protein S, in blood coagulation, 714*t*, 717
- Protein sorting
chaperones and, 619
cotranslational insertion and, 615*f*, 616, 618
disorders, mutations in genes encoding, 625
Golgi apparatus in, 608, 608*f*, 618
importins and exportins in, 612, 612*f*
KDEL amino acid sequence and, 608*t*, 618
membrane assembly and, 624–625
mitochondria in, 609*f*, 610
peroxisomes/peroxisome disorders and, 614, 614*t*
retrograde transport and, 618
signal hypothesis of polyribosome binding and, 609*f*, 614–616, 614*t*
signal sequences and, 607–610, 615*f*
transport vesicles and, 620–624, 621*t*, 622*f*
unfolded protein response in, 619
- Protein structure
primary, 26–29. *See also* Primary structure
quaternary, 37, 39–41, 40*f*
of hemoglobins, allosteric properties and, 54–57
stabilizing factors and, 41
secondary, 37–41
supersecondary, 39
tertiary, 37
stabilizing factors and, 41
- Protein synthesis
amino acids in, 141, 141*f*
reticulocytes and, 692
on ribosomes, 26*f*

- Protein turnover, 89, 287–288
 membranes affecting, 624–625
 rate of enzyme degradation and, 89–90
- Proteinuria, 597
- Proteoglycan aggrecan
 darkfield electron micrograph of, 635f
 schematic representation of, 635f
- Proteoglycans, 157, 569, 573, 634, 638, 643.
See also Glycosaminoglycans
 functions of, 638t
 galactose in synthesis of, 203, 203f
 heparan sulfate, 630
- Proteolysis, 623
 in covalent modification, 92–93, 93f
 in prochymotrypsin activation, 93, 93f
- Proteolytic cleavage, 26f
- Proteolytic enzymes, 68–69
- Proteome, 33
- Proteomics, 3, 465
 goal of, 33
- Prothrombin (factor II), 713f, 714, 714t
 activation of, 714
 coumarin drugs affecting, 717
 in vitamin K deficiency, 555
- Prothrombin time (PT), 598, 598t
- Prothrombin to thrombin activation, by factor Xa,
 714–715
- Protoheme, 122
- Proton acceptors, bases as, 10
- Proton donors, acids as, 10
- Proton motive force, 130
- Proton pumps, 130
 respiratory chain as, 127–130
- Proton shuttle, 65
- Protons, transport of, by hemoglobin, 52–58
- Proton-translocating transhydrogenase, 134
- Proto-oncogenes, 726
 promoter insertion activating, 727f
- Protoporphyrin, 324f, 326
 incorporation of iron into, 324f
 incorporation of iron into heme, 326
- Protoporphyrin III, 326, 328f
- Protoporphyrinogen III, 326, 328f
- Protoporphyrinogen oxidase, 326, 326f, 328f,
 328t
- Provitamin A carotenoids, 547
- Proximal histidine (histidine F8)
 in oxygen binding, 52
 replacement of in hemoglobin M, 58
- Proximity, catalysis by, 63
- PrP. *See* Prion-related protein
- PRPP glutamyl amidotransferase
 defect, gout caused by, 354
 in purine synthesis, 350–351, 351f
 in pyrimidine synthesis, 352, 353f
- PSA. *See* Prostate-specific antigen
- Pseudogenes, 380
- Pseudouridine, 356, 357f
- Psi angle, 37
- PstI*, 452t
- PstI* site, insertion of DNA at, 456f
- PTA. *See* Plasma thromboplastin antecedent
- PTC. *See* Plasma thromboplastin component
- Pteroylglutamic acid. *See* Folic acid
- PTH. *See* Parathyroid hormone
- PTS. *See* Peroxisomal-matrix targeting sequences
- PTS1 and PTS2, 614
- PTSs. *See* Peroxisomal-matrix targeting sequences
- PubMed, 99
- “Puffs,” polytene chromosome, 374, 374f
- Pumps, 485f, 491
 in active transport, 491, 491f
- Purification, protein/peptide, 26–29
- Purine nucleoside phosphorylase deficiency, 355
- Purines/purine nucleotides, 340, 340f, 342f
 biosynthesis of, 348, 348f, 349f, 350f, 351f
 catalysts in, 348
 dietary nonessential, 348
 gout as, 354
 metabolism of, 347–357
 disorders of, 354–355, 356t
 ultraviolet light absorbed by, 342–343
- Puromycin, 426, 427f
- Putrescine, in polyamine synthesis, 317f
- Pyranose ring structures, 154, 154f
- Pyridoxal phosphate, 62, 557
 in heme synthesis, 325
 in urea biosynthesis, 291
- Pyridoxine/pyridoxal/pyridoxamine (vitamin B₆),
 557–558, 557f
 deficiency of xanthurenate excretion in, 308,
 308f
 excess/toxicity of, 558
- Pyrimethamine, 559
- Pyrimidine analogs, in pyrimidine nucleotide
 biosynthesis, 354
- Pyrimidine nucleotide biosynthesis, 352
 multifunctional polypeptides in, 352, 353f
 pathway for, 353f
 regulation of, 354, 354f
- Pyrimidines, 340
- Pyrimidines/pyrimidine nucleotides, 340f, 342f
 dietary nonessential, 348
 metabolism of, 347–357, 355f
 diseases caused by catabolite overproduction
 and, 356–357, 356t
 water-soluble metabolites and, 355–356,
 357f
 precursors of, deficiency of, 356
 synthesis of, 340, 353f
 catalysts in, 352
 purine synthesis coordinated with, 354
 regulation of, 352, 354f
 ultraviolet light absorbed by, 342–343
- Pyrophosphatase, inorganic
 in fatty acid activation, 117, 224
 in glycogen biosynthesis, 176, 177f
- Pyrophosphate
 free energy of hydrolysis of, 116t
 inorganic, 117–118
- Pyrrrole, 52
- Pyruvate, 133, 140
 formation of, in amino acid carbon skeleton
 catabolism, 299f, 301, 303f
 in gluconeogenesis, 146
 oxidation of, 164–165, 166f, 169t, 172–174, 173f,
 174f. *See also* Acetyl-CoA; Glycolysis
 clinical aspects of, 174
 enzymes in, 188t
 gluconeogenesis and, 185–186, 186f
- Pyruvate carboxylase, 164, 165f, 188t
 in gluconeogenesis regulation, 164, 165f, 185,
 188t
- Pyruvate dehydrogenase, 165, 166f, 167, 172, 173f,
 188t
 deficiency of, 174
 regulation of, 173–174, 174f
 acetyl-CoA in, 172–174
 acyl-CoA in, 174f, 237
 thiamin diphosphate as coenzyme for, 555
- Pyruvate dehydrogenase complex, 172
- Pyruvate kinase (PK), 188t
 deficiency of, 174, 694
 gluconeogenesis regulation and, 188
 in glycolysis, 170f, 171, 188t
 regulation and, 172
- Pyruvate kinase (PK) deficiency, 693t
- Q**
- Q cycle, 129, 129f, 130f
- Q-cytochrome c oxidoreductase, 127, 128f
- Q₁₀ (temperature coefficient), enzyme-catalyzed
 reactions and, 77–78
- 5q-syndrome, 692
- QT interval, congenitally long, 496t
- Quadrupole mass spectrometry, 31
- Quaternary structure, 37
 of hemoglobins, allosteric properties and,
 54–57
 stabilizing factors and, 41
- R**
- Rab effector proteins, 621, 623
- Rab molecules, 622
- Rab protein family, 622–623
- Rab proteins, 621
- Radiant energy
 and cancer, 724–726
 DNA damage caused by, 724, 724f
- Radiation, nucleotide excision-repair of DNA
 damage caused by, 389t
- Radioimmunoassay, 596
- Rancidity, peroxidation causing, 219
- Ran proteins, 612, 621t
- RAS (oncogene), 728t
- Rate constant, 76–77
 K_{eq} as ratio of, 76–77
- Rate-limiting reaction, metabolism regulated by,
 89
- RB (tumor suppressor gene), 728t
- Rb protein. *See* Retinoblastoma protein
- RB protein loss, 731
- Reactant concentration, chemical reaction rate
 affected by, 76
- Reactive oxygen species, 693, 758–760, 758f,
 759f
 chain reactions and, 758, 760
 chemically prolific, 758
 enzymatic and chemical mechanisms intercept
 damaging, 762
 generated during respiratory burst, 704
 reaction with biological molecules, 759f
 as toxic byproducts of life, 758f
- Rearrangements, DNA, 434f
 in antibody diversity, 684
- recA, 435
- Receptor-corepressor complex, 520
- Receptor-effector coupling, 500
- Receptor-mediated endocytosis, 492f, 493
- Receptors, 493. *See also* specific type

- Receptors for Fc fragments of IgGs, 704*t*
 Receptors with transport proteins, comparison of, 516, 516*t*
 Recombinant DNA/recombinant DNA technology
 chimeric molecules in, 452–454
 cloning in, 454–455
 DNA ligase in, 452–454
 in enzyme study, 70
 and hematology, 698–699
 restriction enzymes and, 452–454, 452*t*
 technology, 451–468
 Recombinant erythropoietin, 577, 692
 Recombinant fusion proteins, in enzyme study, 70
 Recombination, chromosomal, 379, 379*f*
 Recurrent infections, 581
 Recycle, 623
 Red blood cells. *See also* Erythrocytes
 derivation from hematopoietic stem cells, 689–690
 differentiation scheme, 690*f*
 diseases affecting, 689, 693*t*
 functions of, 690–692
 glucose transporter of, 691, 691*t*
 lifespan of, 692
 membrane of
 biochemical information about, 695*t*
 integral proteins of, 695–696, 695*f*, 695*t*
 peripheral cytoskeletal proteins, 695*t*, 696
 SDS-PAGE analysis, 695, 695*f*
 metabolism of, 691*t*
 glucose transport, 691
 production of oxidants, 694
 reticulocytes and protein synthesis, 692
 production of erythropoietin regulating, 692
 Redox (oxidation-reduction) potential, 119–120, 120*t*
 Redox state, 226
 Red thrombus, 712
 Reduced porphyrins, 326
 Reducing equivalents
 in citric acid cycle, 162–164, 163*f*
 in mitochondria, 127–130, 128*f*
 in pentose phosphate pathway, 198, 200
 Reduction, definition of, 119
 Refsum disease, 231, 614, 614*t*
 Regional asymmetries, membrane, 482
 Regulated secretion, 608
 Regulatory domains, 41
 Regurgitation hyperbilirubinemia, 332
 Relaxation phase
 of skeletal muscle contraction, 654
 of smooth muscle contraction, calcium in, 660
 Relaxed (R) state, of hemoglobin, oxygenation and, 55*f*, 56
 Releasing factors RF1/RF3, in protein synthesis termination, 423, 424*f*
 Remnant removal disease, 275*t*
 Renal function tests, 596–597, 596*t*
 Renal glomerulus, 634
 Renal glucosuria, 597*t*
 Renal threshold for glucose, 193
 Renaturation, DNA, base pair matching and, 361–362
 Repair mechanisms and proofreading for DNA, 762–764
 Repeat sequences, long interspersed, 377
 Repeat sequences, short interspersed, 377, 470
 Repetitive-sequence DNA, 377
 Replication bubbles, 386–387, 386*f*
 Replication fork, 386*f*
 Replication/synthesis. *See* DNA; RNA
 Replicative senescence, 765
 Repression, enzyme, 89
 enzyme synthesis control and, 89
 in gluconeogenesis regulation, 187–188
 Repressor protein/gene, lambda (cI), 433–437, 433*f*, 434*f*, 436*f*
 Repressors in gene expression, 429, 430
 Reproduction, prostaglandins in, 232
 Residues, peptide, 22
 Respiration, oxygen for, 119
 Respiratory burst, 543, 704
 Respiratory chain, 126–135. *See also* Oxidative phosphorylation
 chemiosmotic theory on respiratory control and uncouplers in, 131*f*, 132–133
 clinical aspects of, 135
 complex I and II in, 127, 128, 128*f*
 complex III (Q cycle) in, 127, 128–129, 130*f*
 complex IV in, 127, 128*f*, 130
 dehydrogenases in, 121
 energy captured in catabolism from, 116, 131–132, 169*t*
 flavoproteins and iron-sulfur proteins in, 127–128
 in mitochondria, 128*f*
 mitochondrial protein complexes in, 120*t*, 127, 128*f*
 NADH-Q oxidoreductase as electron acceptor in, 127, 128*f*, 163*f*
 oxidation of reducing equivalents in, 127–130, 128*f*
 oxidative phosphorylation at, 130, 169*t*
 poison inhibition of, 132, 132*f*
 protein gradient driving ATP synthesis from electron transport in, 130–131, 131*f*, 132*f*
 as proton pump, 127–130
 substrates for, citric acid cycle providing, 161–162, 162*f*
 Respiratory control, 114, 166
 ATP supply from, 131–132, 132*t*
 chemiosmotic theory on, 131*f*, 132–133
 Respiratory distress syndrome, surfactant deficiency causing, 216, 250
 Restriction endonucleases/enzymes, 70, 368, 452–454, 452*t*
 in recombinant DNA technology, 452–454, 452*t*, 453*t*
 Restriction enzymes. *See* Restriction endonucleases/enzymes
 Restriction fragment length polymorphisms, 70, 463
 Restriction map, 463
 Retention hyperbilirubinemia, 332
 Reticulocytes and protein synthesis, 692
 Retina
 gyrate atrophy of, 299
 retinaldehyde in, 547
 Retinal. *See* Retinol
 Retinaldehyde, 547
 Retinitis pigmentosa, essential fatty acid deficiency and, 239
 Retinoblastoma protein, 388
 Retinoic acid, 547. *See also* Retinol receptors for, 547
 Retinoids, 547. *See also* Retinol
 Retinoid X receptor, 551
 Retinol, 547. *See also* Vitamin A
 Retinol-binding protein, 672*t*
 Retrograde transport, 618, 621
 from Golgi apparatus, 618
 of misfolded proteins, 618
 Retroposons/retrotransposons, 377
 Retrotranslocation, 619
 Retroviruses, reverse transcriptases in, 364
 Reverse cholesterol transport, 258*f*, 259, 267, 271*f*, 274
 Reversed-phase high-pressure chromatography, for protein/peptide purification, 30
 Reverse-engineering, 106*f*
 Reverse engineering approach, 107
 Reverse transcriptase/reverse transcription, 364, 380, 470
 in recombinant DNA technology, 453*t*
 Reversible covalent modifications, 93–94, 93*f*, 94*t*. *See also* Phosphorylation, protein
 Reye syndrome, orotic aciduria in, 356
 RFLPs. *See* Restriction fragment length polymorphisms
 RFs. *See* Releasing factors
 R groups, amino acid properties affected by, 22–23
 Rheumatoid arthritis, 580, 627
 Rhodopsin, 547, 551*f*
 Rho (p) factor, 398
 Riboflavin (vitamin B₂), 556, 556*f*
 in citric acid cycle, 164
 coenzymes derived from, 62, 556
 deficiency of, 556
 Ribomyopathies, 692
 dehydrogenases dependent on, 121
 Ribonucleases, 368
 Ribonucleic acid. *See* RNA
 Ribonucleoprotein particles, 425, 449
 Ribonucleoside diphosphates, 352, 352*f*
 Ribonucleosides, 340, 340*f*
 Ribonucleotide reductase complex, 352, 352*f*
 Ribose, 152
 in nucleosides, 340, 340*f*
 pentose phosphate pathway in production of, 140, 198, 200
 Ribose 5-phosphate, in purine synthesis, 348–351, 349*f*, 351*f*
 Ribose 5-phosphate ketoisomerase, 198, 199*f*
 Ribose phosphate, pentose phosphate pathway in production of, 196, 197*f*
 Ribosomal dissociation, in protein synthesis, 419
 Ribosomal RNA, 366–367, 394. *See also* RNA as peptidyltransferase, 422, 423*t*
 Ribosomes, 366, 367*t*
 bacterial, 426–427
 protein synthesis in, 26*f*, 144*f*, 145
 dissociation and, 419
 Ribosomopathies, 692
 Ribozymes, 71, 363, 411
 enzyme catalysts, participation of, 71
 ribosome, 71

- RNA world hypothesis, 71
 Ribulose 5-phosphate 3-epimerase, 198, 199*f*
 Richner-Hanhart syndrome, 304
 Ricin, 427
 Rickets, 553
 Rieske Fe-S, 128
 Right-handed superhelix, 628
 Right operator, 433–437, 436*f*
 Rigor mortis, 652, 654
 RNA, 360, 362–368
 as catalysts, 411
 in chromatin, 371
 classes/species of, 364–368, 394
 complementarity of, 363, 364*f*, 366
 heterogeneous nuclear (hnRNA), 368
 messenger (mRNA), 365, 366*f*, 394, 395*t*, 413
 alternative splicing and, 408
 codon assignments in, 414*t*, 415
 nucleotide sequence of, 414
 micro (mi) and small interfering (si), 368
 mutations caused by changes in, 416*f*, 417–418, 418*f*, 430
 recombinant DNA technology and, 460
 processing of, 406–407
 in protein synthesis, 363–364
 relationship to chromosomal DNA, 376*f*
 ribosomal (rRNA), 366–367, 394, 395*t*
 as peptidyltransferase, 422, 423*t*
 small, 367–368
 small nuclear (snRNA), 367, 394, 395*t*, 470
 splicing, 408
 structure of, 362–368, 364*f*, 366*f*, 367*f*
 synthesis of, 360, 395–398
 initiation/elongation/termination in, 397
 transfer (tRNA), 365–366, 367*f*, 394, 395*t*, 415–416, 416*f*
 aminoacyl, in protein synthesis, 422
 anticodon region of, 414–415
 processing and modification of, 411
 suppressor, 418
 RNA editing, 409–411
 RNA-induced silencing complex (RISC), 409
 RNAP. *See* RNA polymerases
 RNA polymerases DNA-dependent, in RNA synthesis, 397
 RNA primer, in DNA synthesis, 385*f*
 RNA processing, alternative, 448–449
 RNA–RNA duplexes, imperfect, 368
 RNA–RNA hybrids, 368
 RNase. *See* Ribonucleases
 RNA transcript, and protein profiling, 465
 RNA viruses, 725
 RNPs. *See* Ribonucleoprotein particles
 ROS. *See* Reactive oxygen species
 Rossmann fold, 40
 Rotor syndrome, 332*t*
 Rough endoplasmic reticulum
 binding to, 609*f*, 614–616, 614*t*
 in protein sorting, 608, 608*f*
 protein synthesis and, 425
 Rough ER branch, 614
 routes of protein insertion into, 609*f*, 616–618
 rRNA. *See* Ribosomal RNA
 R (relaxed) state, of hemoglobin, oxygenation and, 55*f*, 56
 RT-PCR, 470
 RXR. *See* Retinoid X receptor
 Ryanodine, 653
 Ryanodine receptor, 653–654
 diseases caused by mutations in gene for, 654–655
 RYR. *See* Ryanodine receptor
S
 S₅₀, 81
 SAA. *See* Serum amyloid A
 Saccharopine dehydrogenase, 300*t*
 Saccharopine, in lysine catabolism, 306, 306*f*
 SADDAN phenotype, 645
 S-adenosylhomocysteine hydrolase, 300*t*
 S-adenosylmethionine, 308, 308*f*, 315, 316*f*, 343, 343*f*, 344*t*
 biosynthesis of, 316*f*
 Salt (electrostatic) bonds, 8
 oxygen binding rupturing, Bohr effect protons and, 56*f*
 Salts (bile acids), 273–274
 enterohepatic circulation of, 274
 in lipid digestion and absorption, 539
 secondary, 273*f*, 274
 synthesis of, 273–274, 273*f*
 regulation of, 273*f*, 274
 “Salvage” reactions
 in purine synthesis, 349*f*, 350, 351*f*
 in pyrimidine synthesis, 352–351
 Sandwich assay, 596
 Sanger’ method for polypeptide sequencing, 29
 Sanger’ reagent (1-fluoro-2,4-dinitrobenzene), for polypeptide sequencing, 29
 Sarcolemma, 647
 Sarcomere, 648
 Sarcoplasm, 647–648
 Sarcoplasmic reticulum, calcium level in skeletal muscle and, 654
 Sarcosine (N-methylglycine), 318
 SARs. *See* Structure-activity relationships
 Saturated fatty acids, 213, 213*t*
 Saturation kinetics, 81
 sigmoid substrate, Hill equation in evaluation of, 81
 Scaffold, 632
 Scavenger receptor B1, 258*f*, 259
 Schiff bases, 578
 Scrapie, 45
 Screening conditions, drug, enzyme kinetics on, 85
 Scurvy, 281, 285, 562, 631
 collagen affected in, 47
 SDS-PAGE. *See* Sodium dodecyl sulfate-polyacrylamide gel electrophoresis
 Sec12p, 621
 Sec61 complex, 615
 Secondary amyloidosis, 680
 Secondary structure, 37–41
 supersecondary, 39
 Second messengers, 91–92, 500, 520. *See also* specific type
 cAMP as, 179
 cGMP as, 343
 precursors of
 phosphatidylinositol as, 216, 216*f*
 phospholipids as, 245
 Secreted protein, 614
 Secretory component, of IgA, 683*f*
 Secretory (exocytotic) pathway, 608
 Secretory proteins, 615
 Secretory vesicles, 608, 609*f*
 Selectins, 579–580
 Selectivity filter, 488, 489
 Selectivity/selective permeability, membrane, 477, 485–490, 485*t*, 488*f*, 489*t*
 Selenium, 562
 in glutathione peroxidase, 122, 200
 Selenocysteine, 16, 18
 synthesis of, 285–286, 286*f*
 Selenophosphate synthetase/synthase, 285–286, 286*f*
 Self-assembly of lipid bilayer, 480
 Self-association, hydrophobic interactions and, 8
 Sensitivity of lab tests, 592, 592*t*
 Sensory neuropathy, in vitamin B₆ excess, 558
 Sequential displacement reactions, 84
 Serine, 16*t*, 316
 catabolism of, pyruvate formation and, 301, 302*f*
 conserved residues and, 66, 66*t*
 in cysteine and homoserine synthesis, 284–285, 285*f*
 in glycine synthesis, 283, 284*f*
 phosphorylated, 317–318
 synthesis of, 283, 284*f*
 tetrahydrofolate and, 559
 Serine 195, in covalent catalysis, 64–65
 Serine hydroxymethyltransferase, 559
 Serine protease inhibitor, 679
 Serine proteases. *See also* specific type
 conserved residues and, 64–65, 66
 in covalent catalysis, 64–65
 zymogens of, in blood coagulation, 712, 714*t*
 Serotonin, 316, 703*t*
 biosynthesis and metabolism of, 319*f*
 Serpin, 679
 Serum alkaline phosphatase activity, 598
 Serum amyloid A, 680
 Serum complement, 490
 Serum enzymes, in clinical diagnosis, 68*t*
 Serum levels of total thyroxine, 598
 Serum prothrombin conversion accelerator, 712, 712*f*, 713*t*, 714*t*
 coumarin drugs affecting, 717
 Serum urea as marker of renal function, 597
 Sex-hormone-binding globulin, 517
 testosterone and estrogen-binding globulin, 672*t*
 SGLT 1 transporter protein, 538
 SGOT. *See* Aspartate aminotransferase
 SGPT. *See* Alanine aminotransferase
 SHA. *See* Suberoylanilide hydroxamic acid
 SHBG. *See* Sex-hormone-binding globulin
 Shell, of coat proteins, 622
 Short interspersed repeat sequences, 377, 470
 Shoshin beriberi, 555
 Sialic acids, 159, 159*f*, 203, 204*f*, 218
 in gangliosides, 204*f*, 250, 251*f*
 in glycoproteins, 159*t*, 571, 571*t*, 575*f*
 Sickle cell anemia, 693*t*
 Sickle cell disease, 417, 460
 pedigree analysis of, 462*f*

- Side chains, in porphyrins, 323, 324f
- Sigmoid substrate saturation kinetics, Hill equation in evaluation of, 81
- Signal. *See also* Signal peptide
transmission of, 478t. *See also* Signal transduction
- Signal generation, 519–520
- Signal hypothesis, of polyribosome binding, 609f, 614–616, 614t
- Signal peptidase, 615, 615f, 670
- Signal peptide, 608, 614, 615
albumin, 671
in proteins destined for Golgi apparatus membrane, 608
in protein sorting, 608f, 610, 611f, 614, 615f
- Signal recognition particle, 614, 670
- Signal sequence, 614, 622, 670. *See also* Signal peptide
- Signal transduction
across membranes, 494
intracellular messengers in. *See* specific type
in platelet activation, 719f, 720–721
- Signal transduction pathways, 578
and CBP/p300, 532f
- Silencer, of gene expression, 429
- Silencing RNA, 470
- Silent mutations, 416
- Silicon, 562t
- Simple diffusion, 485f, 485t, 486
- Simvastatin, 275
- SINEs. *See* Short interspersed repeat sequences
- Single displacement reactions, 84
- Single-molecule enzymology, 66, 67f
- Single nucleotide polymorphisms, 101, 460, 470
- Single-stranded DNA. *See also* DNA replication from, 381
- Single-stranded DNA-binding proteins, 382f
- 43S initiation complex, in protein synthesis, 419, 420f
- 80S initiation complex, in protein synthesis, 419, 420f
- siRNA-miRNA complexes, 368
- siRNAs, 368
- Sirtuins, 94
- Sister chromatid exchange, 380
- Sister chromatids, 374, 375f
exchange, 380, 381f
- Site-directed mutagenesis, in enzyme study, 71
- Site-specific DNA methylases, 452
- Site-specific integration, 380
- Size exclusion chromatography, for protein/peptide purification, 26, 27, 28f
- SK. *See* Streptokinase
- Skeletal muscle, 653, 663. *See also* Muscle; Muscle contraction
biochemistry, features of, 663t, 664t
characteristics of, 663t
glycogen stores in, 662
glycogen, supplies of, 662
metabolism in, 141f, 143
lactate production and, 171–172
resembles cardiac muscle, 656–657
reserve of protein, 663–664
- Skeletal system, 632
- Skin
essential fatty acid deficiency affecting, 241
vitamin D₃ synthesis in, 552f
- Skin bleeding time, 721
- Sleep, prostaglandins in, 232
- Sliding filament cross-bridge model, of muscle contraction, 648–649
- Slow-reacting substance of anaphylaxis, 242
- Small interfering (si) RNAs, 368
- Small intestine, monosaccharide digestion in, 538
- Small monomeric GTPases, 613, 622
- Small nuclear RNA, 365t, 367, 394, 395t, 470
- Small peptides, presenting, 620
- Small RNA, 367–368
- Smoking on methionine, 679
- Smooth muscle, 653
actin-myosin interactions in, 660
contraction of
calcium in, 659
myosin-based regulation of, 659
myosin light chain phosphorylation in, 659
regulation of contraction by calcium, 659f
relaxation, calcium in, 660
- SNAP (soluble NSF attachment factor) proteins, 622f, 623
- SNARE pins, 623
- SNARE proteins, 621–623, 622f, 623
- SNP. *See* Single nucleotide polymorphisms
- snRNA. *See* Small nuclear RNA
- S1 nuclease, in recombinant DNA technology, 453t
- Sodium, 562
in extracellular and intracellular fluid, 478, 478t
permeability coefficient of, 481f
- Sodium bicarbonate, 663
- Sodium dodecyl sulfate-polyacrylamide gel electrophoresis
for protein/peptide purification, 28, 30f
red blood cell membrane, 695, 695f
- Sodium-potassium pump (Na⁺-K⁺-ATPase), 490–491, 491f
in glucose transport, 491, 492f
- Solubility point, of amino acids, 21–22, 22f
- Soluble NSF attachment factor (SNAP) proteins, 622f, 623
- Soluble proteins, 615
- Solutions, aqueous, Kw of, 10
- Solvent, water as, 6–7, 7f
- Somatic mutation theory of aging, 763
- Sorbitol
in diabetic cataract, 205
intolerance, 205
- Sorbitol dehydrogenase, 202f, 203
- Sorbitol (polyol) pathway, 205
- Soret band, 327
- Southern blot transfer procedure, 362, 470
- Southwestern blot transfer procedure, 470
- SPCA. *See* Serum prothrombin conversion accelerator
- Special translocation mechanisms, 611
- Specific acid/base catalysis, 63
- Specificity, enzyme, 61
- Specificity of lab tests, 592, 592f, 592t
- Spectrin, 694, 695t, 696
- Spectrometry, covalent modifications detected by, 31, 31t, 32f
- Spectrophotofluorimetry, 593, 594f
- Spectrophotometry
for NADP⁺-dependent dehydrogenases, 67–68, 67f
for porphyrins, 327–329
- Spectroscopy, nuclear magnetic resonance (NMR), 43–44
- Spermidine, synthesis of, 316, 317f
- Spermine, synthesis of, 316, 317f
- S phase of cell cycle, DNA synthesis during, 388–389, 388f, 388t
- Spherocytosis, hereditary, 496t
- Sphingolipidoses, 251, 251t
- Sphingolipids, 245
metabolism of, 249–250, 250f
clinical aspects of, 250–251, 251t
in multiple sclerosis, 250–251
- Sphingomyelins, 215, 217f, 250, 250f, 624
membrane asymmetry and, 482
in membranes, 479, 482
- Sphingophospholipids, 212
- Sphingosine, 215, 217f
- Spina bifida, folic acid supplements in prevention of, 560
- Spliceosome, 470
- Spongiform encephalopathies, transmissible (prion diseases), 45
- Spontaneously assemble, 630
- Spontaneous mutations, 724
- 43S preinitiation complex, in protein synthesis, 420f
- 48S preinitiation complex, in protein synthesis, 419–420
- Squalene
in cholesterol synthesis, 267–268, 268f
synthesis of, 269f
- Squalene epoxidase, in cholesterol synthesis, 268, 269f
- SR, 614, 614t
- SR-B1. *See* Scavenger receptor B1
- SRP. *See* Signal recognition particle
- SRS-A. *See* Slow-reacting substance of anaphylaxis
- SSBs. *See* Single-stranded DNA-binding proteins
- ssDNA. *See* Single-stranded DNA
- Stabilization, of unfolded or partially folded intermediates, 608–610
- STAR. *See* Steroidogenic acute regulatory protein
- Starch, 156, 158f
glycemic index of, 538
hydrolysis of, 538
- Starling forces, 669
- Starvation, 113
clinical aspects of, 149
fatty liver and, 261
ketosis in, 231
metabolic fuel mobilization in, 148–149, 148t, 149f
triacylglycerol redirection and, 257
- Statin drugs, 267, 267f, 275
- Stearic acid, 213t
- Stem cell
definition, 689
potency, 689
- Stem cell biology, 3, 464
- Stem cell factor, 690
- Stem cells role in cancer, 736
- Stereochemical (-sn) numbering system, 215, 216f

- Stereoisomers, 216, 219*f*. *See also* Isomerism of steroids
- Steroid hormone as precursor molecule, 501
- Steroid nucleus, 218*f*, 219, 219*f*
- Steroidogenesis. *See* Steroids
- Steroidogenic acute regulatory protein, 503
- Steroid receptors, 500
- Steroids, 218–219, 218*f*, 219*f*. *See also* specific type
adrenal. *See* Glucocorticoids;
Mineralocorticoids
affinity for serum-binding proteins, 516*t*
stereoisomers of, 218–219, 219*f*
storage of, 515*t*
synthesis of, 141, 141*f*
- Steroid sulfates, 250
- Sterol 27-hydroxylase, 273
- Sterols, 218, 479
- Stickler syndrome, 643
- Sticky end ligation/sticky-ended DNA, 452, 453*f*
- “Sticky patch,” in hemoglobin S, 58
- Stochastic processes, mortality and aging as, 756
- Stoichiometry, 74
- Stokes radius, in size exclusion chromatography, 27
- Stop codon, 423, 424*f*
- Stop-transfer signal, 616
- Strain, catalysis by, 63
- Streptokinase, 69, 718–719
- Streptomycin, 156
- Striated muscle, 649*f*, 652–653. *See also* Cardiac muscle; Skeletal muscle
actin-myosin interactions in, 660*t*
- Strong acids, 10
- Strong bases, 10
- Structure-activity relationships, 107
- Stuart-Prower factor (factor X), 712*f*, 713*t*, 714*t*
activation of, 712*f*, 713–714
coumarin drugs affecting, 717
- Suberoylanilide hydroxamic acid, 735
- Substrate analogs, competitive inhibition by, 82
- Substrate level, phosphorylations at, 129*f*, 131
- Substrates, 64
 β subunit, 615
competitive inhibitors resembling, 82
concentration of, enzyme-catalyzed reaction rate affected by, 78–79
Hill model of, 79–81
Michaelis-Menten model of, 81
conformational changes in enzymes caused by, 64, 64*f*
- Substrate shuttles, 134, 134*f*, 135*f*
coenzymes as, 62
- Succinate, 163*f*
- Succinate dehydrogenase, 121, 163*f*, 164
inhibition of, 82
- Succinate Q reductase, 127, 128, 128*f*
- Succinate semialdehyde, 320, 321*f*
- Succinate thiokinase (succinyl-CoA synthetase), 163*f*, 164
- Succinic acid, pK/pK_a value of, 13*t*
- Succinyl-CoA-acetoacetate-CoA transferase (thiophorase), 164, 227
- Succinyl-CoA, in heme synthesis, 325–327, 325*f*, 328*f*
- Succinyl-CoA synthetase (succinate thiokinase), 163*f*, 164
- Sucrose-isomaltase complex, 538
- Sucrose, 156, 157*f*, 157*t*
glycemic index of, 538
- Sugar code of life, 570
- Sugars, 156. *See also* Carbohydrates
amino (hexosamines), 156, 156*f*
classification of, 152–153, 153*t*
glucose as precursor of, 203, 204*f*
in glycosaminoglycans, 156, 203, 204*f*
in glycosphingolipids, 203, 204*f*
interrelationships in metabolism of, 204*f*
in amphipathic lipids, 480
deoxy, 156, 159*f*
isomerism of, 153–154, 154*f*
“Suicide enzyme,” cyclooxygenase as, 240
- Sulfate, 571
active (adenosine 3'-phosphate-5'-phosphosulfate), 343, 343*f*
- Sulfatide, 218
- Sulfation, 586
- Sulfogalactosylceramide, 250
accumulation of, 251
- Sulfo(galacto)-glycerolipids, 250
- Sulfonamides, 694
- Sulfonylurea drugs, 231
- Sulfotransferases, 636
- Sunlight. *See* Ultraviolet light
- Supercoils, DNA, 362, 387, 387*f*
- Superoxide, 124, 567, 693. *See also* Free radicals
- Superoxide dismutase, 124–125, 220, 693
- Supersecondary structures, 39
- Suppressor mutations, 418–419
- Suppressor tRNA, 418
- Supravalvular aortic stenosis, 632
- Surfactant, 245
deficiency of, 216, 250
- Symbolic logic, in molecular interaction maps, 107–108, 108*f*
- Symport systems, 487
- Synacthen stimulation test, 599
- Synaptic vesicles, 623
- Synaptobrevin, 623
- Syn conformers, 340*f*, 341–342, 341*f*
- Synthetic biology, 3–4
- Synthetic chemistry, 570
- Systems biology, 3, 107–108
- T**
- $t_{1/2}$. *See* Half-life
- T_3 . *See* Triiodothyronine
- T_4 . *See* Thyroxine
- TAFs. *See* TBP-associated factors
- Tag SNPs, 101
- Tamoxifen, 740*t*
- Tandem, 470
- Tandem mass spectrometry, 33
- Tangier disease, 275*t*
- TaqI*, 452*t*
- Target cell, 495
concept of, 498–499
determinants of concentration of hormone at, 499*t*
- Targeted gene disruption/knockout, 464–465
- Tarui disease, 179*t*
- TATA-binding protein, 400
- TATA box, in transcription control, 400, 403
- Taurochenodeoxycholic acid, synthesis of, 273*f*
- Taut (T) state, of hemoglobin
2,3-bisphosphoglycerate stabilizing, 57
oxygenation and, 55
- Tay-Sachs disease, 251*t*
- TBG. *See* Thyroxine-binding globulin
- tblastn, 103
- tblastx, 103
- TBP. *See* TATA-binding protein
- TBP-associated factors, 400
- Telomerase, 374, 765
activity in cancer cells, 732
- Telomeres, 374, 375*f*
composition, 765
functions of, 765
in replication, 765*f*
- Temperature
chemical reaction rate affected by, 74
enzyme-catalyzed reaction rate affected by, 77–78
in fluid mosaic model of membrane structure, 483
- Temperature coefficient (Q_{10}), enzyme-catalyzed reactions and, 77–78
- Template binding, in transcription, 397
- Template strand DNA, 360, 364, 364*f*
transcription of in RNA synthesis, 395
- Tenase complex, 712, 713
- Tenofovir disoproxil fumarate, 85
- Terminal transferase, 453*t*, 470
- Termination
chain, in transcription cycle, 397
of protein synthesis, 423, 424*f*
of RNA synthesis, 396
- Termination signals, 414
or bacterial transcription, 403
- Tertiary structure, 40*f*
stabilizing factors and, 41
- Testicular steroidogenesis, 505
- Testosterone, 501
biosynthesis pathway, 506*f*
metabolic product of, 505
metabolism, 505
- Tethering, 621, 623
- Tetracycline (Tet) resistance genes, 455
- Tetrahedral transition state intermediate, in acidbase catalysis, 64
- Tetrahydrobiopterin, 285*f*
- Tetrahydrofolate, 559, 559*f*, 560*f*
- Tetraiodothyronine (thyroxine; T_4), 510
in plasma, 516*t*
storage of, 515*t*
synthesis, 510
- Tetramers
hemoglobin as, 54
histone, 371, 373
- Tetroses, 152, 153*t*
- Tf. *See* Transferrin
- TFIIA, 403
- TFIIB, 403
- TFIID, 403, 404
- TFIIE, 403
- TFIIF, 403
- TFPI. *See* Tissue factor pathway inhibitor
- TfR. *See* Transferrin receptor
- TGN. *See* Trans Golgi network
- Thalassemias, 58

- Thanatophoric dysplasia, 645
- Theobromine, 342, 342*f*
- Theophylline, 342, 343*f*
- Thermodynamics
 biochemical (bioenergetics), 113–116. *See also*
 ATP
 glycolysis reversal and, 185–187
 laws of, 113–114
 hydrophobic interactions and, 8
- Thermogenesis, 264, 264*f*
 diet-induced, 264, 542, 543
- Thermogenin, 132, 264, 264*f*
- Thiamin (vitamin B₁), 555–556, 555*f*
 in citric acid cycle, 164
 coenzymes derived from, 62
 pyruvate metabolism affected by, 173, 174, 555–556
- Thiamin diphosphate, 172, 198, 555, 555*f*
- Thiamin pyrophosphate, 62
- Thiamin triphosphate, 555
- Thick (myosin) filaments, 648, 650
- Thickness, of bilayer, 624
- Thin (actin) filaments, 549–650, 648
- Thioesterase, 233, 233*f*, 234
- 6-Thioguanine, 344, 344*f*
- Thiokinase (acyl-CoA synthetase)
 in fatty acid activation, 224, 224*f*
 in triacylglycerol synthesis, 246, 262*f*, 264
- Thiolase, 224*f*, 225, 225*f*, 227
 in mevalonate synthesis, 267, 267*f*
- Thiol ester plasma protein family, 680
- Thiophorase (succinyl-CoA-acetoacetate-CoA transferase), 164, 227
- Thioredoxin, 352
- Thioredoxin reductase, 352, 352*f*
- Threonine, 16*t*
 catabolism of, 303
 phosphorylated, 317–318
 requirements for, 544
- Thrombin, 712, 712*f*, 716*f*
 antithrombin III affecting, 717
 controlling circulating levels of, 717
 formation of fibrin and, 715–717, 716*f*
 in platelet activation, 719*f*, 720
 from prothrombin, factor Xa activation of, 714–715
- Thrombocytopenia, 698
- Thrombolysis
 laboratory tests in evaluation of, 721
 t-PA and streptokinase in, 718–719, 718*f*
- Thrombomodulin, in blood coagulation, 714*t*, 717, 721*t*
- Thrombopoietin, 690
- Thrombosis, 711–721. *See also* Coagulation (blood)
 antithrombin III in prevention of, 717
 circulating thrombin levels and, 717
 endothelial cell products in, 720, 721*t*
 hyperhomocysteinemia and, folic acid supplements in prevention of, 560
 phases of, 711
 in protein C or protein S deficiency, 717
 t-PA and streptokinase in management of, 718–719, 718*f*
 types of thrombi and, 712
- Thromboxane A₂, 214*f*
 in platelet activation, 719*f*, 720
- Thromboxanes, 213, 214*f*, 232, 239
 clinical significance of, 242
 cyclooxygenase pathway in formation of, 239, 241*f*
- Thymidine, 341*t*
 base pairing in DNA, 360, 361*f*
- Thymidine monophosphate (TMP), 341*t*
- Thymidylate, 359
- Thymine, 341*t*
- Thymine dimer formation and UV light, 761, 761*f*
- Thyroglobulin, 510
- Thyroid auto-antibodies, 599
- Thyroid-binding globulin, 672*t*
- Thyroid disorders, lab diagnoses of, 598*t*
- Thyroid function tests, 598–599, 598*t*
 serum levels of total thyroxine, 598
 thyroid stimulating hormone, 598
- Thyroid hormone receptors, 500
- Thyroid hormones, 510
 in lipolysis, 263, 263*f*
 regulation of gene expression by, 519*f*
- Thyroid-stimulating hormone, measurement of, 598, 598*t*
- Thyroxine (T₄), 501, 510, 598
- Thyroxine-binding globulin, 516
- Ticagrelor, 721
- Tight junctions, 484
- Tightly bound inhibitors, 83
- Tiglyl-CoA, catabolism of, 311*f*
- TIM. *See* Translocase-of-the-inner membrane
- Time of flight mass spectrometry, 31
- Timnodonic acid, 213*t*
- Tin, 562*t*
- Tissue differentiation, retinoic acid in, 547
- Tissue factor (factor III), 712, 712*f*
- Tissue factor pathway inhibitor, 713
- Tissue plasminogen activator, 69, 718–719, 718*f*
- Tissue protein breakdown, 663
- Titin, 655
- T lymphocytes, 681, 706
- Tm. *See* Melting temperature/transition temperature
- TMP (thymidine monophosphate), 341*t*, 342*f*
- Tocopherol, 550*t*, 553*f*. *See also* Vitamin E
 as antioxidant, 125, 220, 553
 α -tocopherol, 567
- Tocotrienol, 553, 553*f*. *See also* Vitamin E
- Tolbutamide, 231
- TOM. *See* Translocase-of-the-outer membrane
- Topogenic sequences, 616
- Topoisomerases, DNA, 362, 386, 387*f*
- Total iron-binding capacity, 674
- Toxic hyperbilirubinemia, 332
- Toxicity, vitamin, 546
- Toxins, microbial, 490
- t-PA. *See* Tissue plasminogen activator
- TpC. *See* Troponin C
- TpI. *See* Troponin I
- TpT. *See* Troponin T
- TRAM (translocating chain-associated membrane) protein, 614
- Transactivator proteins, 439–440
- Transaldolase, 198, 199*f*
- Transaminases. *See* Aminotransferases
- Transamination, 141, 141*f*
 in amino acid carbon skeleton catabolism, 298–299, 298*f*
 citric acid cycle in, 164, 165*f*
 in urea biosynthesis, 290–291, 290*f*
- Transcortin. *See* Corticosteroid-binding globulin
- Transcription, 362–363, 465
 activators and coactivators in control of, 404–405
 bacterial promoters in, 399
 eukaryotic, 403–405
 eukaryotic promoters in, 400–403
 in gene expression regulation, 433–437. *See also* Gene expression
 initiation of, 396
 retinoic acid in regulation of, 547
 reverse in retroviruses, 364, 387
 in RNA synthesis, 360
- Transcription complex, eukaryotic, 401*f*, 403–405
- Transcription control elements, 405*t*
- Transcription factors, 405*t*
 in regulation of enzymatic catalysis, 89–90
- Transcription unit, 396
- Transcriptome information, 465
- Transcriptomics, 3
- Transcript profiling, 465
- Transcytosis, 623
- Trans fatty acids, 213, 239
- Transfected cells in culture, 443
- Transferases, 61
- Transferrin, 541, 668, 672*t*, 673–674, 676
- Transferrin cycle, 675*f*
- Transferrin receptor, 674–675, 678
- Transfer RNA, 365–366, 394, 395*t*, 415–416, 416*f*.
See also RNA
 aminoacyl, in protein synthesis, 422
 anticodon region of, 414–415
 processing
 and modification of, 411
 precursors for, 409
 suppressor, 418
- Transforming factor beta (TGF- β), 730
- Transgenic animal approach, 442
- Transgenic animals, 464
- Transglutaminase, in blood coagulation, 712, 714*t*, 716*f*
- Trans Golgi network, 608
- Transhydrogenase, proton-translocating, 134
- Transient insertion signal. *See* Signal peptide
- Transition mutations, 416, 416*f*
- Transition state, 74–75
 analogs, 63
 intermediate, 63
 formation during simple chemical reaction, 75*f*
 tetrahedral, in acid-base catalysis, 64
 stabilization, 63
- Transition temperature/melting temperature (Tm), 361, 483
- Transketolase, 198, 199*f*
 erythrocyte, in thiamin nutritional status assessment, 556
 thiamin diphosphate in reactions involving, 198, 556
- Translation, 414
- Translocase-of-the-inner membrane, 610

- Translocase-of-the-outer membrane, 610
- Translocating chain-associated membrane (TRAM) protein, 614
- Translocation
 into lumen, 614
 protein, 26*f*, 610
- Translocation complexes, 610
- Translocon, 615
- Transmembrane proteins, 67*f*
 ion channels as, 487–489, 488*f*, 489*t*
- Transmembrane signaling, 477, 494, 720–721
 in platelet activation, 719*f*, 720–721
- Transmissible spongiform encephalopathies, 45
- Transporters/transport systems, 481, 616. *See also* specific type
 active, 485, 485*f*, 485*t*, 487
 active transport involving, 486–487
 ATP-binding cassette, 258*f*, 259
 comparison with ion channels, 486*t*
 in cotranslational insertion, 616, 617*f*
 facilitated diffusion, 485*f*, 485*t*, 486, 487, 488*f*
 genes encoding, 625
 glucose. *See* Glucose transporters
 membrane, 487
 passive diffusion involving, 485–486
- Transport proteins, 672*t*
- Transport vesicles, 608, 616, 621–623, 621*t*, 622*f*
 defined, 621
 in intracellular traffic, 620–624
 in vesicle coating, 621
- Transposition, 380
 retroposons/retrotransposons and, 377
- Transthyretin, 680
- Transverse asymmetry, 624
- Transverse movement, of lipids across membrane, 482
- Transversion mutations, 416, 416*f*
- Trastuzumab, 740*t*
- Trauma, protein loss and, 544
- Trehalase, 538
- Trehalose, 157*t*
- Triacylglycerols (triglycerides), 215, 216*f*, 254, 263–264
 in adipose tissue, 140
 digestion and absorption of, 538–539, 540*f*
 interconvertibility of, 145–146
 in lipoprotein core, 254–255, 255*f*
 metabolism of, 140, 141*f*, 143, 143*f*
 in adipose tissue, 261, 262*f*
 fatty liver and, 260–261, 260*f*
 hepatic, 259–260
 high-density lipoproteins in, 258–259, 258*f*
 hydrolysis in, 246
 reduction of serum levels of, drugs for, 274, 275
 synthesis of, 246–250, 247*f*
 transport of, 255–257, 256*f*, 257*f*
- Tricarboxylate anions, transporter systems for lipogenesis regulation and, 237
- Tricarboxylic acid cycle. *See* Citric acid cycle
- Triglycerides. *See* Triacylglycerols (triglycerides)
- Triiodothyronine (T₃), 510
 in plasma, 516*t*
 storage of, 515*t*
 synthesis, 510
- Trimethoprim, 559
- Trinucleotide repeat expansions, 378
- Triokinase, 202, 202*f*
- Triose phosphate isomerase, 40*f*
- Triose phosphates, acylation of, 140
- Trioses, 152, 153*t*
- Triphosphates, nucleoside, 340, 341*f*
- Triple helix structure, of collagen, 46–47
- Triplet code, genetic code as, 414*t*
- tRNA. *See* Transfer RNA
- Tropocollagen, 46, 630
- Tropoelastin, 631
- Tropomyosin, 648, 650*f*, 652, 695*t*
 as striated muscle inhibitor, 653
- Troponin C, 653
- Troponin I, 652–653
- Troponin, in diagnosis of myocardial infarction, 69
- Troponin T, 652
- Troponin/troponin complex, 648, 650*f*, 652–653
 as striated muscle inhibitor, 653
- Trypsin, 539
 conserved residues and, 66*t*
 in digestion, 539
- Trypsinogen, 539
- Tryptophan, 17*t*, 316, 547
 catabolism of, 306–308, 307*f*
 deficiency of, 557
 niacin synthesized from, 557
 permeability coefficient of, 481*f*
 requirements for, 544
- Tryptophan oxygenase/L-tryptophan oxygenase (tryptophan pyrrolase), 123, 307*f*, 308
- TSEs. *See* Transmissible spongiform encephalopathies
- TSH. *See* Thyroid-stimulating hormone
- t-SNARE proteins, 621, 623
- T (taut) state, of hemoglobin
 2,3-bisphosphoglycerate stabilizing, 56*f*
 oxygenation and, 55
- Tubular proteinuria, 597*t*
- Tumor biomarkers, 739*t*, 740
- Tumors, 722
 immunology of, 741–742
 pH and oxygen tension in, 739
- Tumor suppressor genes, 2–3
 functions of, 727–730
 and oncogenes, difference between, 728*t*
p53, 392
 properties of, 728*t*
 role in colorectal cancer development, 728–730, 729*f*
- Tumor viruses, 725
 oncogenes, 727–728
- Turnover of cell, 757*t*
- Twin lamb disease. *See* Pregnancy toxemia of ewes
- Twisted gastrulation 1 (TWSG1), 677
- Two-dimensional electrophoresis, protein expression and, 33
- TXs. *See* Thromboxanes
- Type 1 diabetes mellitus. *See* Insulin-dependent diabetes mellitus
- Type 1 leukocyte adhesion deficiency, 703
- Type A response, in gene expression, 429–430, 429*f*
- Type B response, in gene expression, 429*f*, 430
- Type C response, in gene expression, 429*f*, 430
- Type I collagen, 640
- Type I Crigler-Najjar syndrome (congenital nonhemolytic jaundice), 333
- Type IV collagen, 631
- Type IX collagen, 630
- Type V collagen, 640
- Tyrosine, 17*t*, 317, 320*f*, 501
 catabolism of, 304, 305*f*
 epinephrine and norepinephrine formed from, 320*f*
 in hemoglobin M, 58
 hormone synthesis from, 509–515
 phosphorylated, 317–318
 requirements for, 544
 synthesis of, 285, 285*f*
- Tyrosine aminotransferase, 300*t*
 defect in tyrosinemia, 304
- Tyrosine derivatives, 502*f*
- Tyrosine hydroxylase in catecholamine biosynthesis, 509
- Tyrosine kinase inhibitors, 740
- Tyrosinemia, 304
- Tyrosinosis, 304
- ## U
- Ubiquitination, 26*f*
 of misfolded proteins, 620, 620*f*
- Ubiquinone (Q/coenzyme Q), 219
 in cholesterol synthesis, 268*f*, 269
 in respiratory chain, 127, 128*f*, 129*f*
- Ubiquitin and protein degradation, 288–289, 620, 620*f*
- Ubiquitination, 90, 288
- UDPGal. *See* Uridine diphosphate galactose
- UDPGlc. *See* Uridine diphosphate glucose
- UDP-Glc pyrophosphorylase, 571*f*
- UDP-glucose. *See* Uridine diphosphate glucose
- UFA (unesterified fatty acids). *See* Free fatty acids
- Ulcers, 537
- Ultraviolet light
 nucleotide absorption of, 342–343
 vitamin D synthesis and, 552
- Ultraviolet (UV) radiation, 761, 761*f*
 carcinogenicity, 724
- UMP (uridine monophosphate), 341*t*, 342*f*
- Uncleaved insertion sequences, 616
- Unconjugated bilirubin, disorders occurring of, 332
- Unconjugated hyperbilirubinemia, 334*t*
- Uncouplers/uncoupling proteins
 on respiratory chain, 131*f*, 132
 undernutrition and, 543
- Uncoupling protein, 132
- Undernutrition, 537, 541–543
- Unequal crossover, 379, 379*f*
- Unesterified fatty acids. *See* Free fatty acids
- Unfolded protein response, 619
- Uniport systems, 485*f*, 487
- UniProtKB, 101
- Unique-sequence (nonrepetitive) DNA, 377
- Unsaturated fatty acids, 213, 213*t*. *See also* Fatty acids
cis double bonds in, 213, 215*f*
 dietary, cholesterol levels affected by, 274
 eicosanoids formed from, 232, 239, 241*f*, 242*f*

- Unsaturated fatty acids (*Cont.*):
 essential, 238, 238f
 abnormal metabolism of, 241
 deficiency of, 239
 prostaglandin production and, 232
 in membranes, 479f, 480, 481f
 metabolism of, 239
 oxidation of, 226, 227f
 structures of, 238f
 synthesis of, 238–239, 239f
- Uracil, 341t
- Uraciluria-thyminuria, 347, 356
- Urate, as antioxidant, 220
- Urea
 amino acid metabolism and, 141, 141f
 gene therapy for, 296
 nitrogen catabolism producing, 292–293
 permeability coefficient of, 481f
 synthesis of, 290–291, 290f, 291f
 active enzymes, 750t
 metabolic disorders associated with, 294–296, 295t
- Urea cycle disorders, 295
- Uric acid, 342, 342f
 purine catabolism in formation of, 354, 355f
- Uridine, 340f, 341t
- Uridine diphosphate galactose, 203
- Uridine diphosphate galactose (UDPGal), 571
- Uridine diphosphate galactose 4-epimerase, 203, 203f
- Uridine diphosphate glucose (UDP-Glc), 176, 177f, 571
 in glycogen biosynthesis, 176, 177f
- Uridine diphosphate glucose dehydrogenase, 201f
- Uridine diphosphate glucose pyrophosphorylase, 200, 201f
 in glycogen biosynthesis, 176, 177f
- Uridine diphosphate-glucuronate/glucuronic acid, 200, 201f
- Uridine monophosphate (UMP), 341t, 342f
- Uridine triphosphate (UTP), in glycogen biosynthesis, 176, 177f
- Uridyl transferase deficiency, 205
- Urine, abnormal constituents of, 596–597, 597t
- Urobilinogens, 334t
 conjugated bilirubin reduced to, 332
 in jaundice, 333–334
 normal values for, 334t
- Urocanic aciduria, 299, 300t
- Urokinase, 718, 718f
- Uronic acid, 634
- Uronic acid pathway, 196, 200, 201f
 disruption of, 205
- Uronic acids, 159
- Uroporphyrinogen decarboxylase, 325f, 326, 326f, 328f, 328t
 in porphyria, 328t
- Uroporphyrinogen I, 326, 326f, 328f
- Uroporphyrinogen III, 326, 326f, 328f
- Uroporphyrinogen I synthase, in porphyria, 328t
- Uroporphyrins, 324f
 spectrophotometry for detection of, 327–329
- UTP, in phosphorylation, 118
- V**
- Valeric acid, 213t
- Valine, 16t
 catabolism of, 309, 310f, 311f
 interconversion of, 285
 requirements for, 544
- Valinomycin, 134
- Vanadium, 562t
- van der Waals forces, 8, 8f, 360
- Variable numbers of tandemly repeated units, 574
 in forensic medicine, 464
- Variable regions/segments, 683
 gene for, 684
 immunoglobulin heavy chain, 683
 immunoglobulin light chain, 683, 684
 of immunoglobulins, 684
- Vascular endothelial growth factor, 736
- Vasodilators, 647
 nitric oxide as, 660–661
- Vector cloning, 455t
- Vegetarian diet, vitamin B₁₂ deficiency and, 558
- VEGF. *See* Vascular endothelial growth factor
- Velocity
 initial, 78
 inhibitors affecting, 82
 maximal (V_{max})
 allosteric effects on, 91
 inhibitors affecting, 79
 Michaelis-Menten equation in determination of, 79
 substrate concentration and, 78–79
- Very low carbohydrate diets, weight loss from, 194
- Very low density lipoprotein receptor, 255, 257
- Very low density lipoproteins, 143, 253–254, 254t, 272, 274
 in fed state, 148
 hepatic secretion of, dietary and hormonal status and, 259–260, 260f
 metabolism of, 143, 143f, 255–258, 257f
 in triacylglycerol transport, 256f, 257f
- Vesicles
 cell-cell communication, 494–496
 coating, 621, 622f
 brefeldin A affecting, 623
 genetic approaches to study, in yeast, 621
 secretory, 608, 609f
 targeting, 620f
 transport, 608, 620–624, 620f, 621t
 types and functions, 621t
- V_i . *See* Initial velocity
- Villefranche classification, 631t
- Vimentins, 666
- Viral infection, 620
- Viral oncogenes. *See* Oncogenes
- Virtual cells, 107
- Virtual libraries, screening of, 105–106, 105f
- Viruses
 cancer caused by, 725, 726t
 host cell protein synthesis affected by, 425, 426f
- Vision, vitamin A in, 547, 551f
- Vitamin A, 547, 551f
 deficiency of, 551
 excess/toxicity of, 551
 functions of, 547
 in vision, 547, 551f
- Vitamin B₁ (thiamin), 555–556, 555f
 in citric acid cycle, 164
 coenzymes derived from, 62
 deficiency of, 555–556
 pyruvate metabolism affected by, 173, 174, 555–556
- Vitamin B₂ (riboflavin), 556, 556f
 in citric acid cycle, 164
 coenzymes derived from, 62, 556
 deficiency of, 556
 dehydrogenases dependent on, 121
- Vitamin B₆ (pyridoxine/pyridoxal/pyridoxamine), 557–558, 557f
 deficiency of, 308f, 557
 xanthurenate excretion in, 308
 excess/toxicity of, 558
- Vitamin B₁₂ (cobalamin), 558–559, 558f
 absorption of, 558
 intrinsic factor in, 541
 deficiency of, 559
 in methylmalonicaciduria, 187
- Vitamin B complex. *See also* specific vitamin
 in citric acid cycle, 164
 coenzymes derived from, 62
- Vitamin B₁₂-dependent enzymes, 558
- Vitamin C (ascorbic acid), 196, 561–562, 561f, 568t
 as antioxidant, 220
 benefits from, 562
 coenzyme, 561–562
 in collagen synthesis, 47, 562
 deficiency of, 562
 collagen affected in, 47
 iron absorption and, 541, 562
- Vitamin D, 551–553
 in calcium absorption, 541, 552
 deficiency of, 553
 ergosterol as precursor for, 219, 219f
 excess/toxicity of, 553
 metabolism of, 552–553
- Vitamin D₃ (cholecalciferol), 552
 as antioxidant, 124, 219
 formation and hydroxylation of, 508f
- Vitamin E, 553, 553f, 564, 567
- Vitamin H. *See* Biotin
- Vitamin K, 553–555, 554f
 calcium-binding proteins and, 554–555
 in coagulation, 554
 deficiency of, 555
- Vitamin K-dependent coagulation factors, 717
 coumarin anticoagulants affecting, 717
- Vitamin K hydroquinone, 554, 555f
- Vitamins, 3, 546–563, 550t
 in citric acid cycle, 164
 digestion and absorption of, 541, 542f
 lipid- (fat-) soluble, 547–555, 550t
 metabolic functions of, 547
 nutrient intake of, 548t–549t
 water-soluble, 550t, 555–562
- VLDL. *See* Very low density lipoproteins
- V_{max} . *See* Maximal velocity
- VNTRs. *See* Variable numbers of tandemly repeated units
- Voltage-gated channels, 489, 489f, 490f, 658t
- von Gierke disease, 179t, 355

- von Hippel-Lindau syndrome, 289
 von Willebrand disease, 698, 718
 von Willebrand factor, 718, 720
 in platelet activation, 720
 V region/segment. *See* Variable regions/segments
 v-SNARE proteins, 621–623
- W**
- Warburg effect, 738
 Warfarin, 554, 555, 717
 vitamin K affected by, 554
 Water, 3, 6–7
 as biologic solvent, 6–7, 7*f*
 biomolecular structure and, 7–8, 7*t*
 dissociation of, 9–10
 in hydrogen bonds, 7, 7*f*
 as nucleophile, 9–10
 permeability coefficient of, 481*f*
 structure of, 7*f*
 Water channels, 490
 Water-soluble hormones, 500
 Watson-Crick base pairing, 8, 360, 361*f*
 Waxes, 212
 Weak acids, 13
 buffering capacity of, 12–13
 dissociation constants for, 11–12
 Henderson-Hasselbalch equation describing
 behavior of, 12
 physiologic significance of, 11–12
 pK/pK_a values of, 13
 Weak bases, 10
 Wear and tear theories of aging, 756–762
 free radicals, 760
 hydrolytic reactions, 756–758, 757*f*
 mitochondria, 760–761
 molecular repair mechanisms and, 762–764
 protein glycation, 761–762, 762*f*
 reactive oxygen species, 758–760, 758*f*, 759*f*
 ultraviolet radiation, 761, 761*f*
 Wernicke encephalopathy, 556
 Wernicke-Korsakoff syndrome, 550*t*
 White blood cells, 700–707. *See also* specific type
 integrins in, 702–703, 703*t*
 regulation, 701
 White thrombus, 712
 Williams-Beuren syndrome, 632
 Wilson disease, 496*t*, 676
 ceruloplasmin levels in, 676
 gene mutations in, 496*t*, 676
 methylhistidine in, 315
 Wobble, 416
 Women, iron needs of, 673
- X**
- Xanthine, 342, 342*f*
 Xanthine oxidase, 120
 deficiency of, hypouricemia and, 355
 Xanthurenate, excretion of in vitamin B₆
 deficiency, 308, 308*f*
 Xenobiotic-metabolizing enzymes, factors
 affecting, 587
 Xenobiotics
 definition, 583
 metabolism of, 583–584
 conjugation reactions, 586–587
 enzymes involved in, 583
 for excretion from body, 583–584, 586–587
 phases of, 583–584, 584–585
 principal classes of, 583
 responses to
 antigenicity, 587
 carcinogenic, 587–588
 immunological, 587–588
 pharmacologic, 587–588
 toxic, 587–588, 587*t*
 Xerophthalmia, vitamin A deficiency in, 550*t*, 551
 X-linked disorders, RFLPs in diagnosis of, 463
 X-ray diffraction and crystallography, protein
 structure demonstrated by, 41–43
- Y**
- Yeast artificial chromosome (YAC) vector, 455
 Yeast cells fermentation, 1–2
 Yeast cells, mitochondrial protein import studied
 in, 610
- Z**
- Zellweger (cerebrohepatorenal) syndrome, 231,
 614, 614*t*
 Zinc, 562
 Zinc fingers, 444–445
 Z line, 648, 649*f*
 Zona pellucida, 579
 ZP. *See* Zona pellucida
 Zwitterions, 20
 Zymogens, 92–93, 539, 668
 in blood coagulation, 712, 713*f*, 714*t*
 rapid response to physiologic demand and,
 92–93